



US00D673952S

(12) **United States Design Patent**
Toda et al.

(10) **Patent No.:** **US D673,952 S**
(45) **Date of Patent:** **** Jan. 8, 2013**

(54) **INFORMATION TERMINAL DEVICE**

(75) Inventors: **Naotoshi Toda**, Tokyo (JP); **Shinji Higashiyama**, Tokyo (JP)

(73) Assignee: **King Jim Co., Ltd.**, Tokyo (JP)

(**) Term: **14 Years**

(21) Appl. No.: **29/381,734**

(22) Filed: **Dec. 22, 2010**

(30) **Foreign Application Priority Data**

Jun. 28, 2010 (JP) 2010-015740

(51) **LOC (9) Cl.** **14-02**

(52) **U.S. Cl.** **D14/383**; D14/389

(58) **Field of Classification Search** D14/302-307,
D14/900-902; D13/163; D20/10; D21/332,
D21/325, 369, 370; D99/28; D6/397, 466;
194/206; 361/679.01, 679.02, 679.04, 679.21,
361/679.57, 725

See application file for complete search history.

(56) **References Cited**

U.S. PATENT DOCUMENTS

D303,956 S * 10/1989 Ditzik D14/335
D362,427 S * 9/1995 Mizusugi et al. D18/4.4
D385,903 S * 11/1997 Kim D18/4.4
D385,904 S * 11/1997 Kim D18/4.4

D428,046 S * 7/2000 Berger D18/4.6
D428,047 S * 7/2000 Kolls D18/4.6
D447,140 S * 8/2001 Mittler D14/383
D451,535 S * 12/2001 Lee D18/4.6
D468,735 S * 1/2003 Landerholm et al. D14/336
D480,725 S * 10/2003 Funato D14/383
D507,592 S * 7/2005 Mizusugi et al. D18/4.1
D514,565 S * 2/2006 Haygood D14/371
D585,056 S * 1/2009 Ekelund D14/336

* cited by examiner

Primary Examiner — Austin Murphy

(74) *Attorney, Agent, or Firm* — Banner & Witcoff, Ltd.

(57) **CLAIM**

The ornamental design for an information terminal device, as shown and described.

DESCRIPTION

FIG. 1 is a perspective view of the top, front and right of an information terminal device showing our new design;

FIG. 2 is a front view thereof;

FIG. 3 is a rear view thereof;

FIG. 4 is a top plan view thereof;

FIG. 5 is a bottom view thereof;

FIG. 6 is a right side view thereof, the left side view being mirror image thereof;

FIG. 7 is a reference view of usage;

FIG. 8 is a reference view of usage; and,

FIG. 9 is an ended view at a line 9-9 shown in FIG. 8.

The portions of the article in broken lines are shown for illustrative purposes only and form no part of the claimed design.

1 Claim, 8 Drawing Sheets

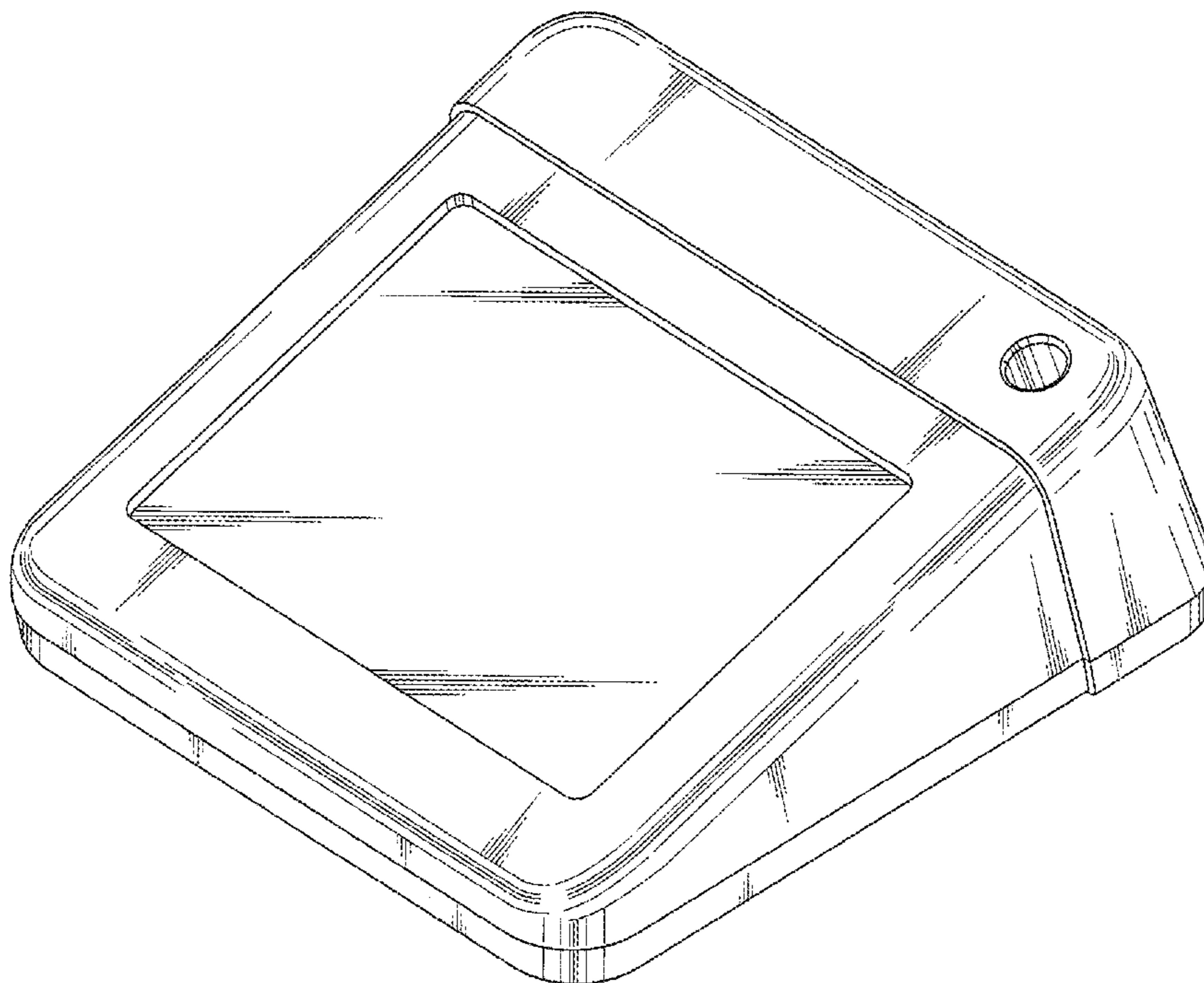

Fig. 1

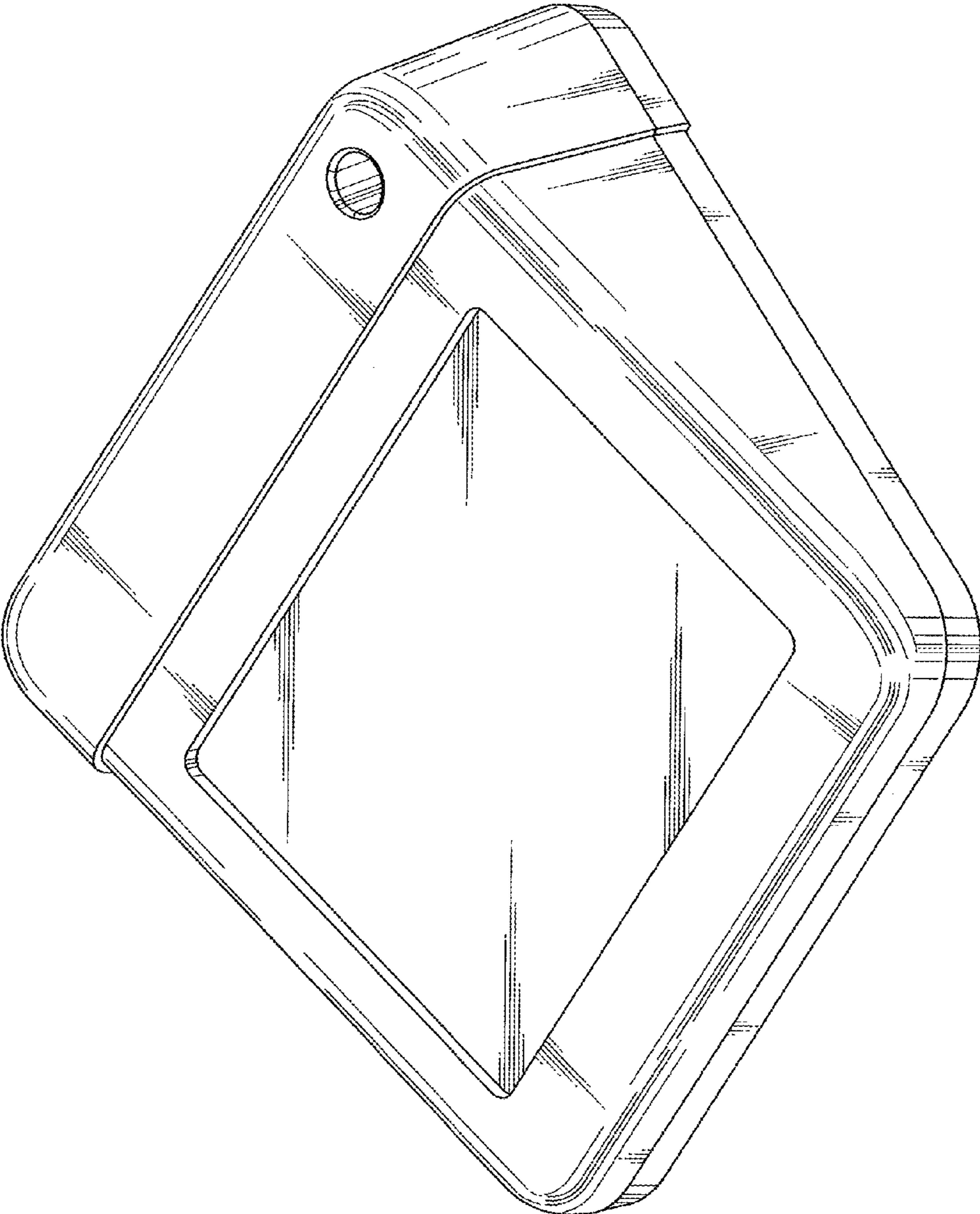

Fig. 2

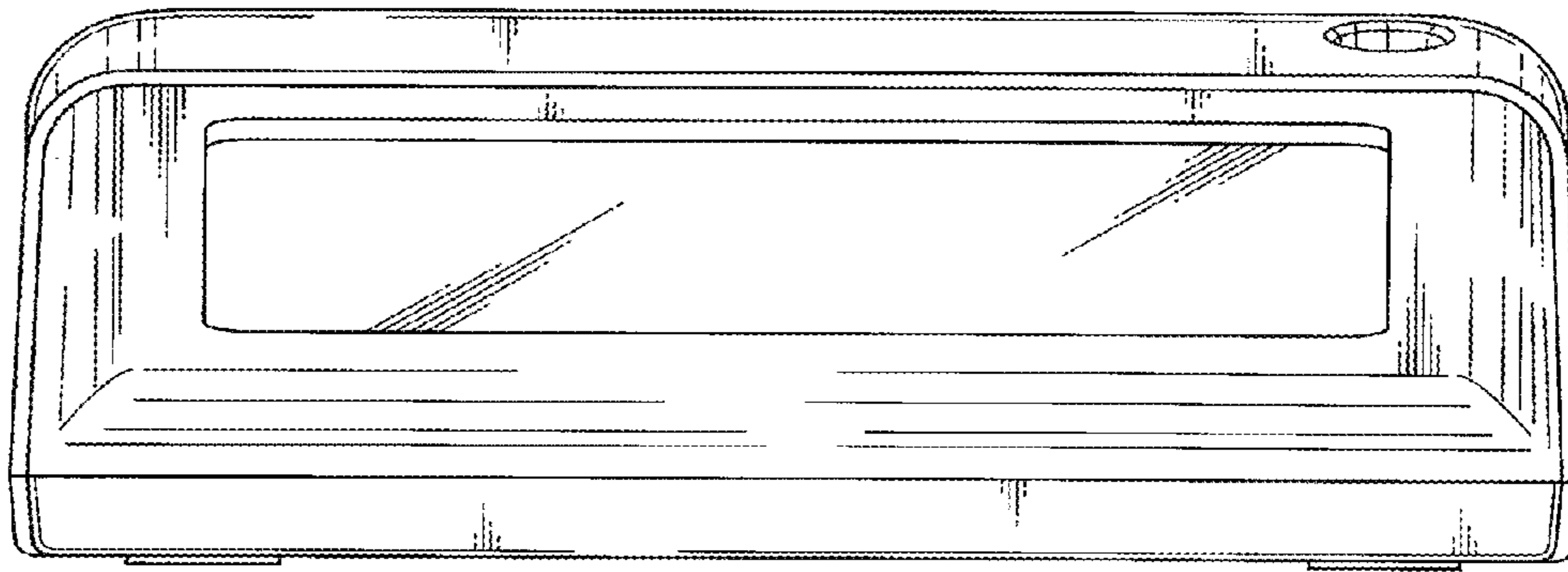

Fig. 3

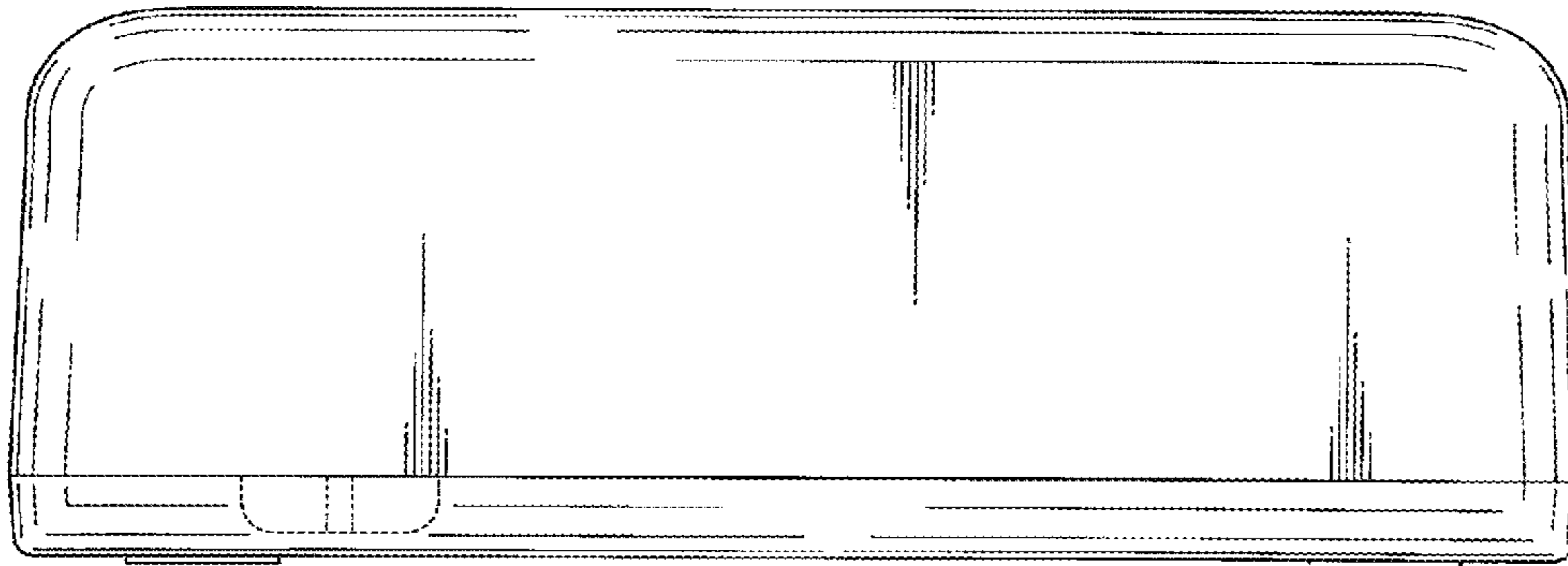

Fig. 4

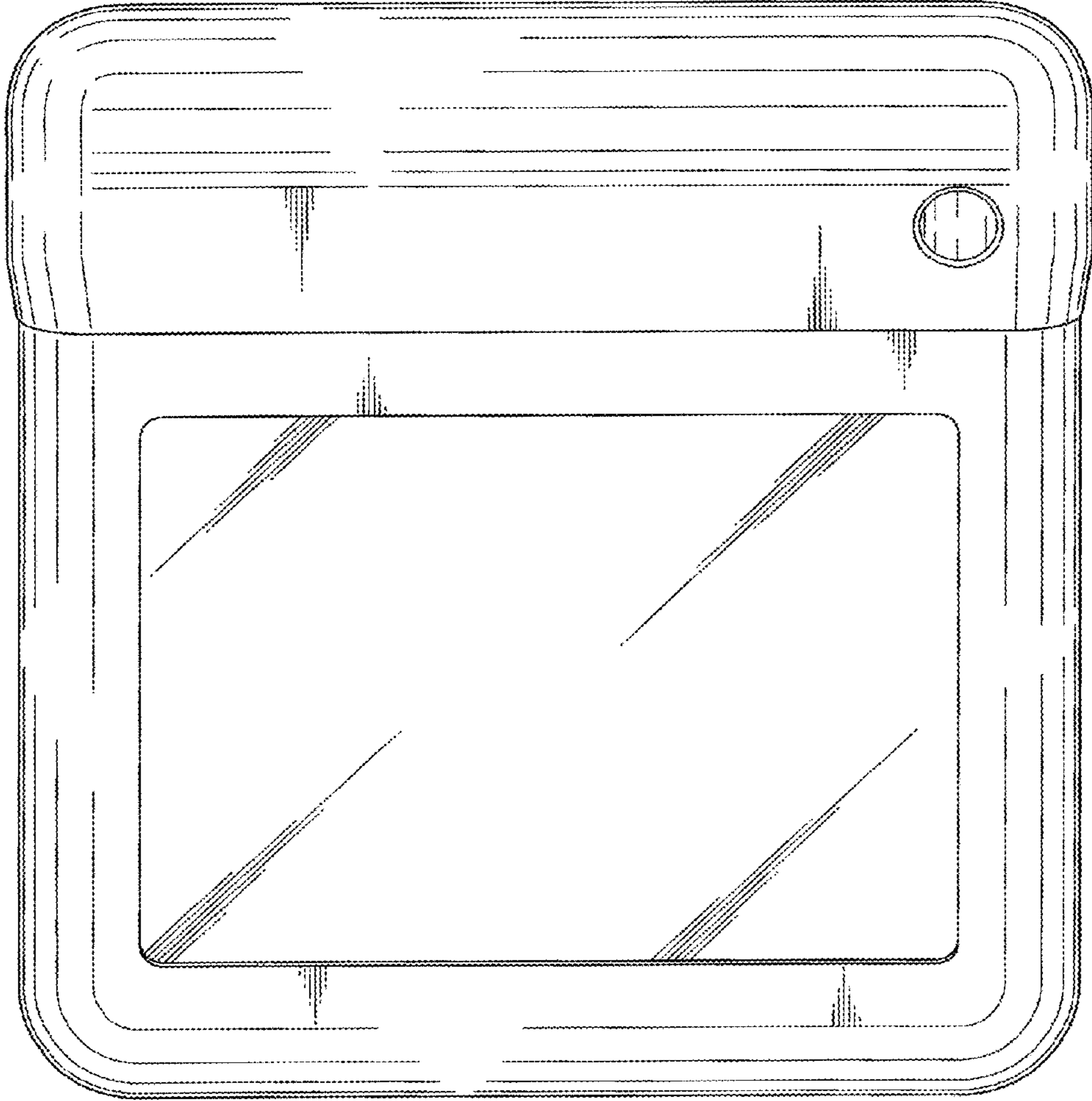

Fig. 5

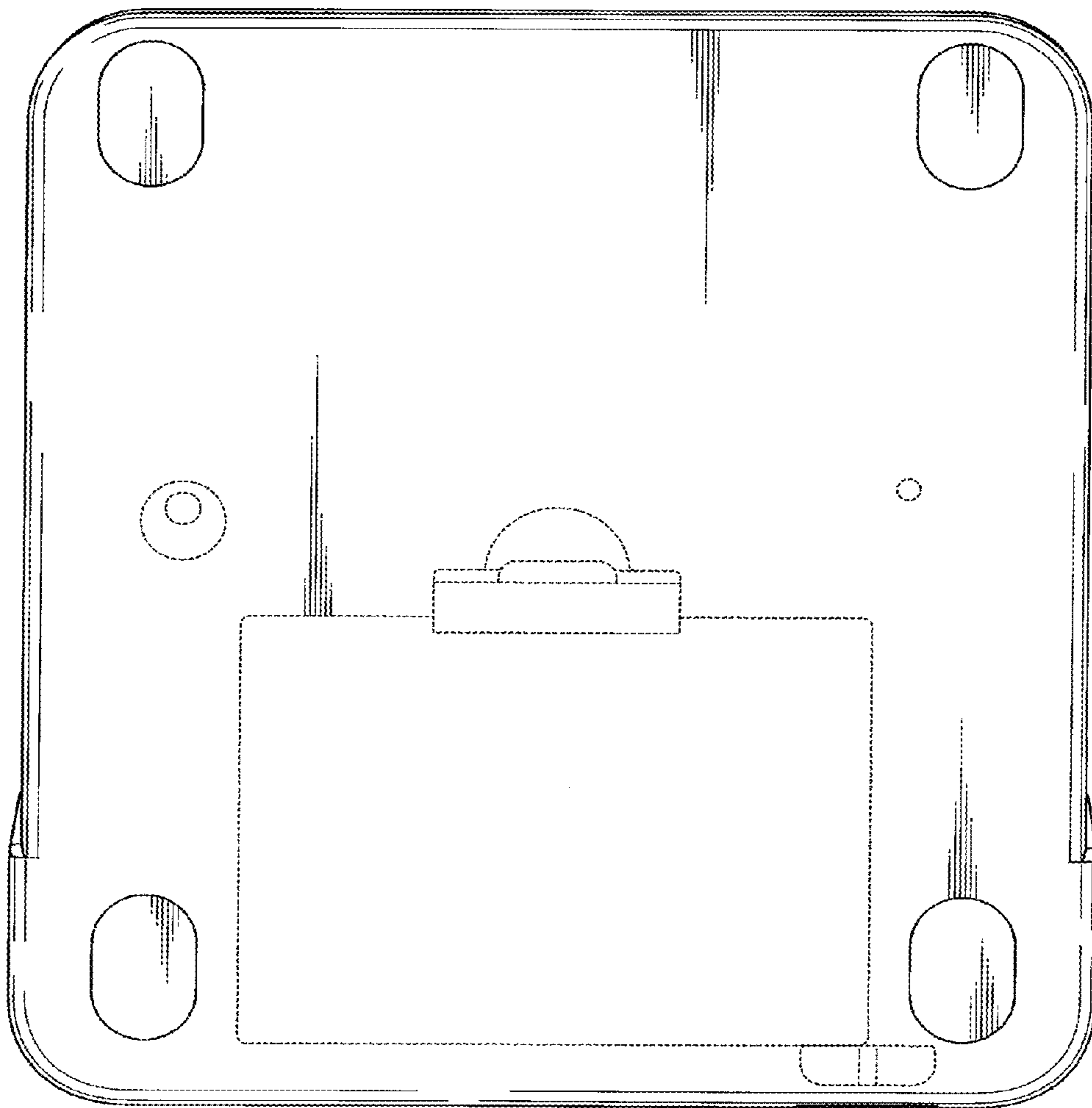
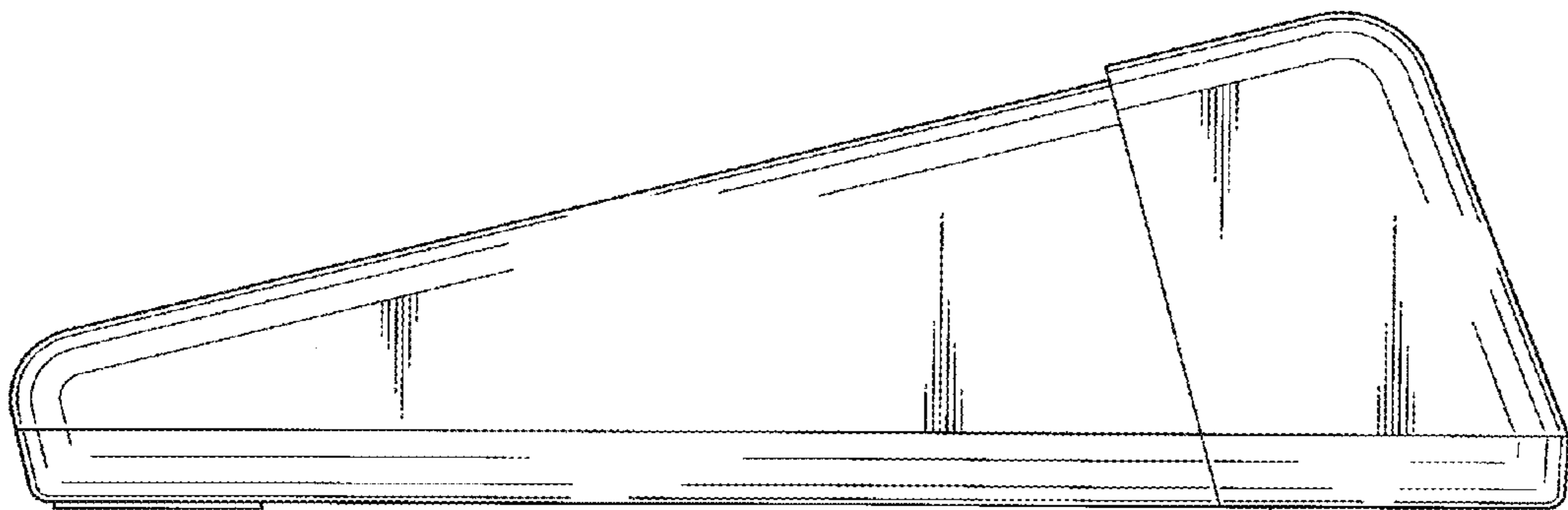

Fig. 6



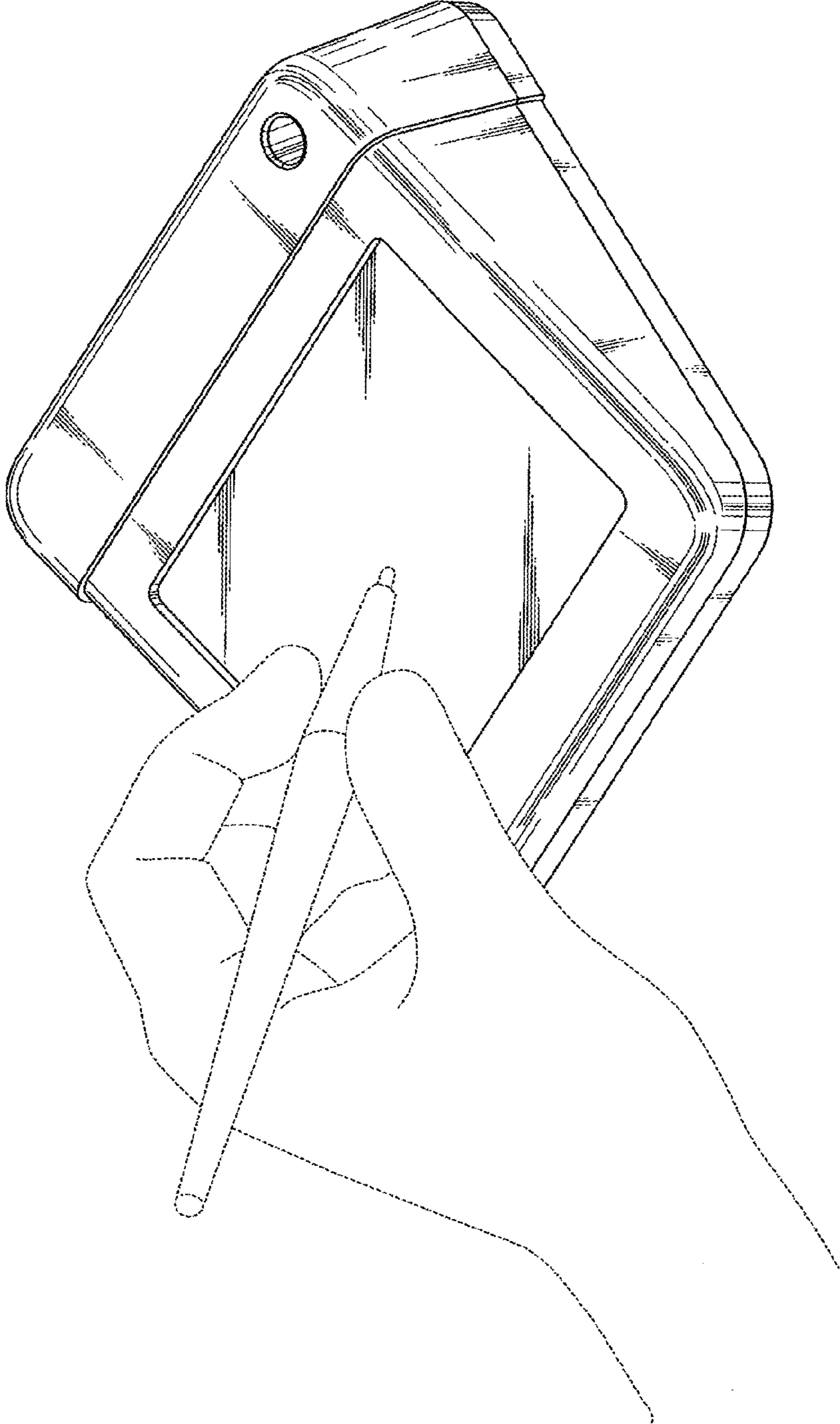

Fig. 7

Fig. 8

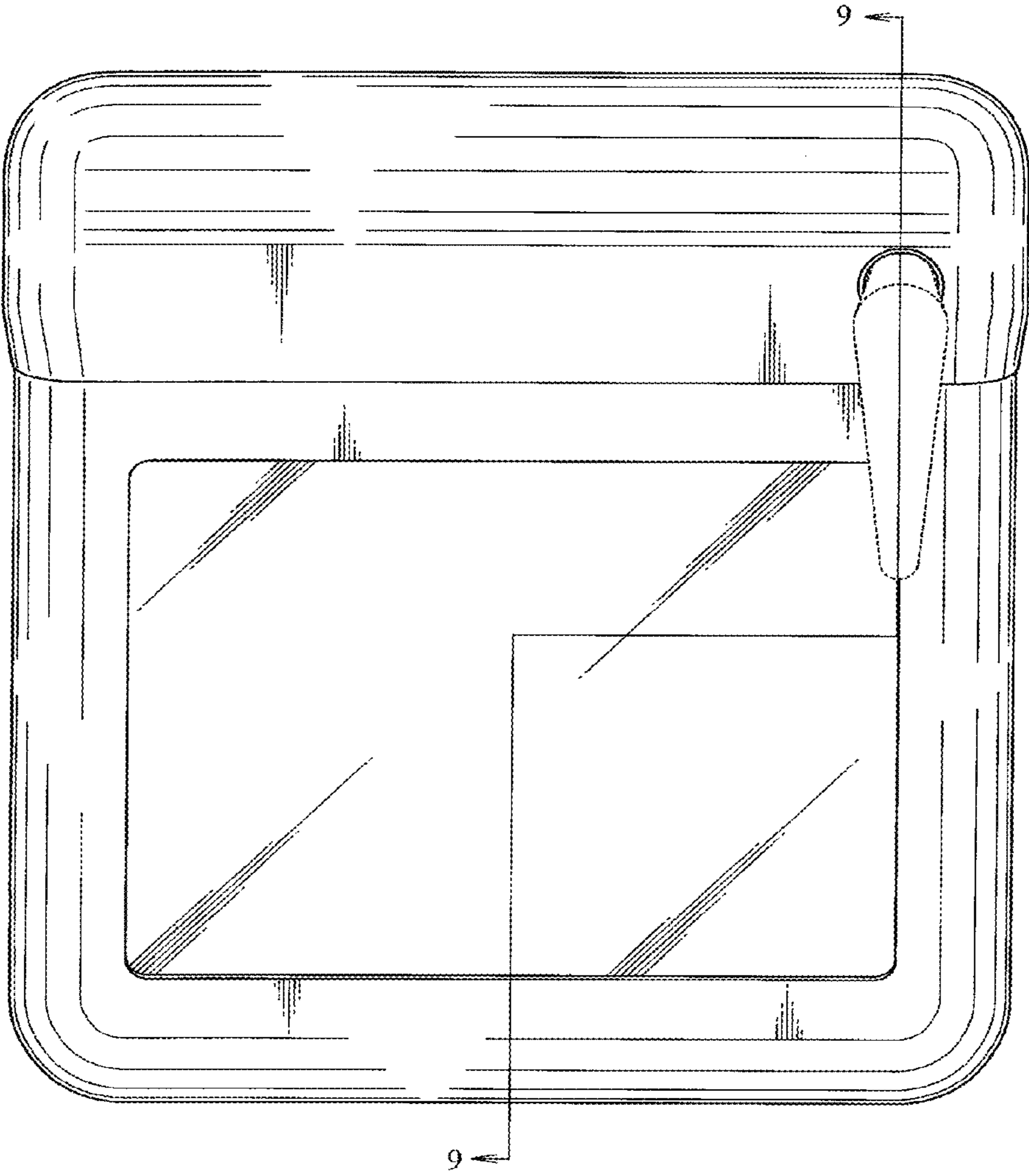

Fig. 9

