



US00D673935S

(12) **United States Design Patent**
Lee

(10) **Patent No.:** **US D673,935 S**
(45) **Date of Patent:** **** Jan. 8, 2013**

(54) **HOME GATEWAY DEVICE**
(75) Inventor: **Sang-Ho Lee**, Gyeonggi-do (KR)
(73) Assignee: **Kaonmedia Co., Ltd.**, Gyeonggi-Do (KR)

D633,495 S * 3/2011 Yoon et al. D14/356
D642,167 S * 7/2011 Brandt et al. D14/240
D647,091 S * 10/2011 Yoon et al. D14/356
D662,496 S * 6/2012 Lewis et al. D14/240
2005/0238089 A1* 10/2005 Kodama et al. 375/222
2007/0018067 A1* 1/2007 Huang 248/346.03
2011/0197246 A1* 8/2011 Stancato et al. 725/111

(**) Term: **14 Years**
(21) Appl. No.: **29/404,736**
(22) Filed: **Oct. 25, 2011**

OTHER PUBLICATIONS

U.S. Appl. No. 29/404,752 to Sang-Ho Lee, filed Oct. 25, 2011.
U.S. Appl. No. 29/404,757 to Sang-Ho Lee, filed Oct. 25, 2011.

(30) **Foreign Application Priority Data**
May 6, 2011 (KR) 30-2011-0018555
(51) **LOC (9) Cl.** **14-03**
(52) **U.S. Cl.** **D14/240; D14/358**
(58) **Field of Classification Search** D14/240,
D14/242, 357, 358, 140-140.9, 155, 137,
D14/139, 243, 348, 349, 351, 354, 355; 375/222;
455/557; 725/111
See application file for complete search history.

* cited by examiner

Primary Examiner — Bridget L Eland
(74) *Attorney, Agent, or Firm* — Greenblum & Bernstein P.L.C.

(56) **References Cited**
U.S. PATENT DOCUMENTS
D494,156 S * 8/2004 Chen et al. D14/240
6,776,345 B1 * 8/2004 Liang 235/486
7,092,375 B2 * 8/2006 Pitsoulakis 370/338
D610,133 S * 2/2010 Asano D14/240
D620,900 S * 8/2010 Harden et al. D14/125

(57) **CLAIM**
I claim the ornamental design for a home gateway device, as shown and described.

DESCRIPTION

FIG. 1 is a perspective view of a home gateway device, showing my new design;
FIG. 2 is a front elevational view thereof;
FIG. 3 is a bottom view thereof;
FIG. 4 is a top plan view thereof;
FIG. 5 is a left side elevational view thereof;
FIG. 6 is a right side elevational view thereof; and,
FIG. 7 is a rear elevational view thereof.

1 Claim, 6 Drawing Sheets

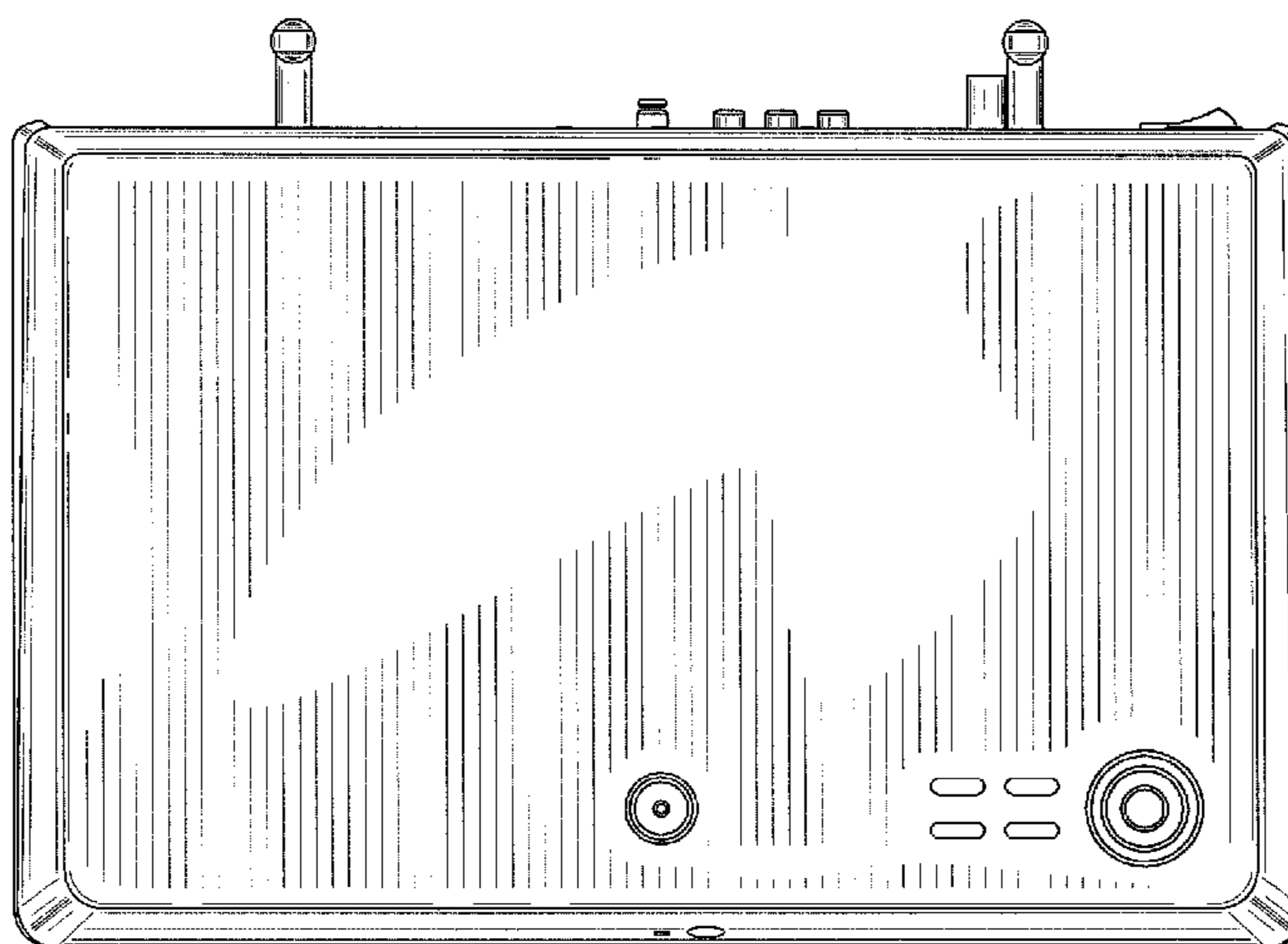

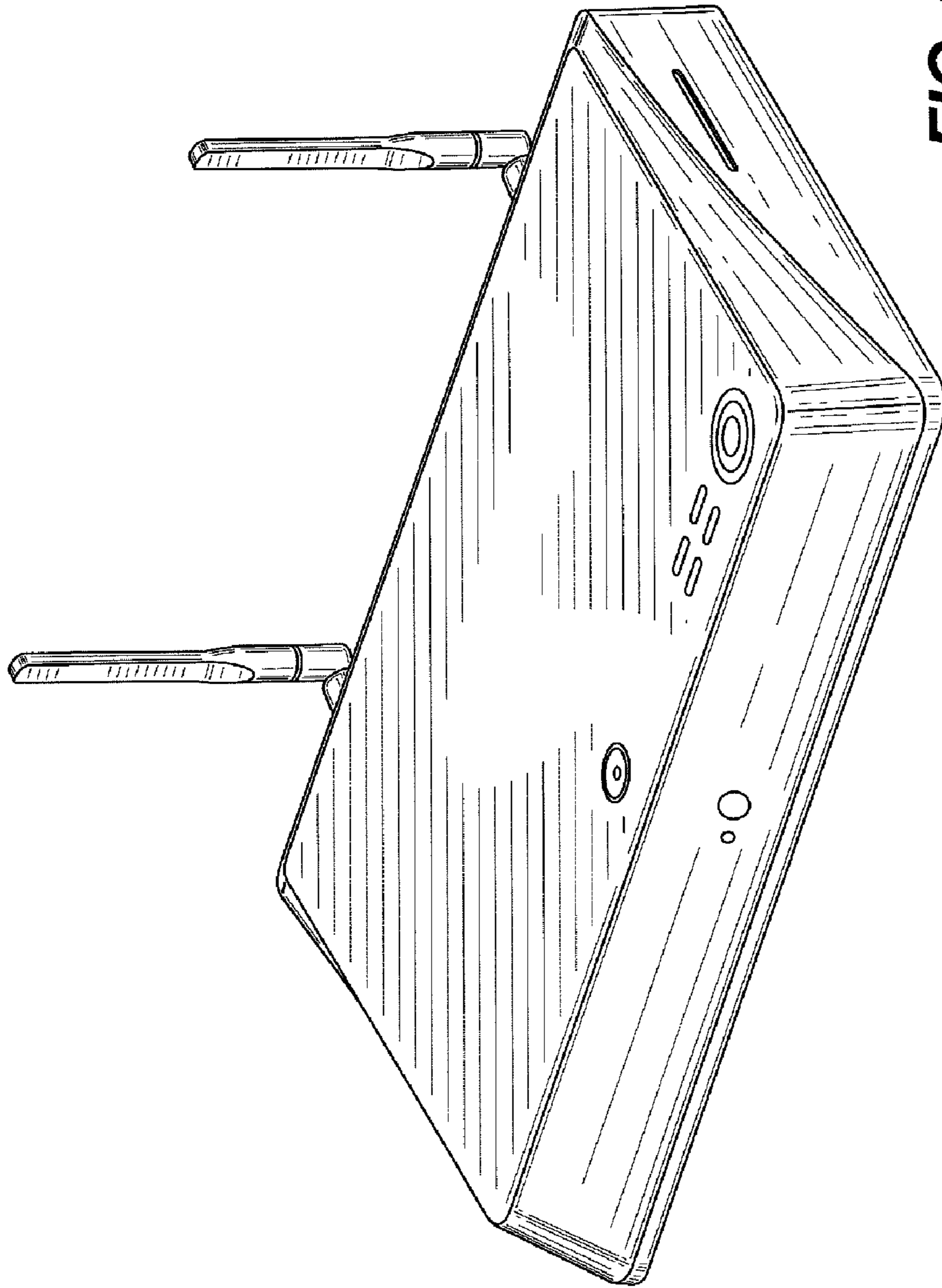

FIG. 1

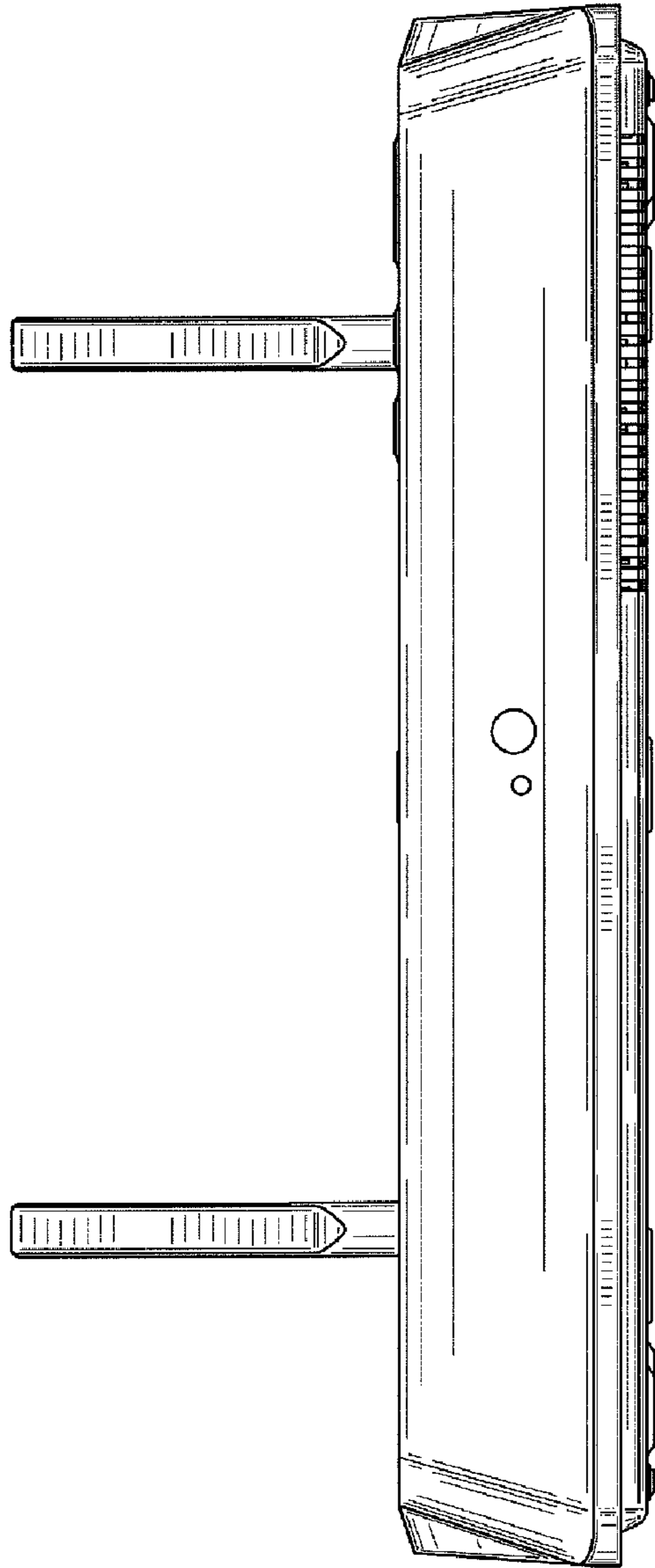

FIG. 2

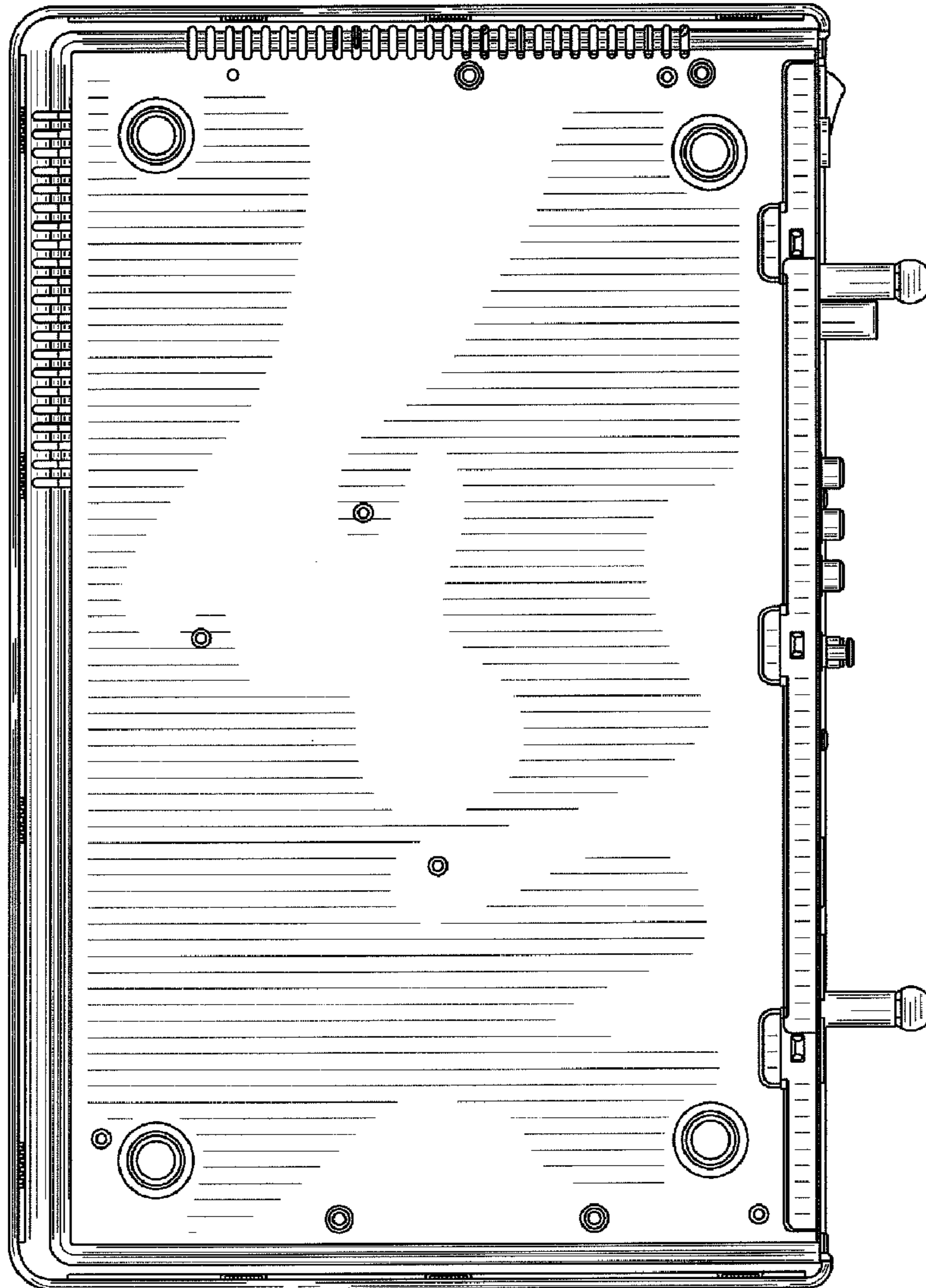

FIG. 3

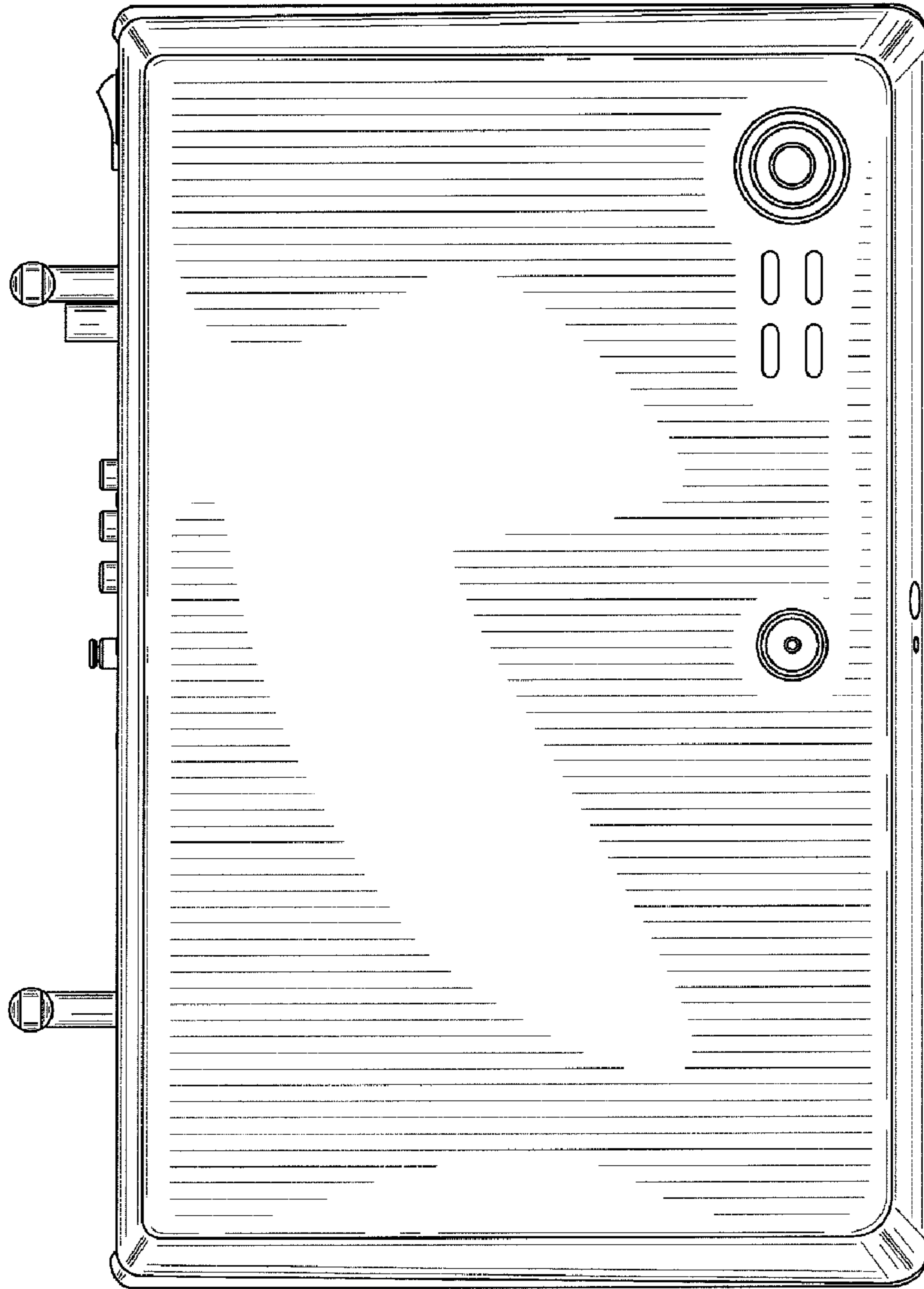

FIG. 4

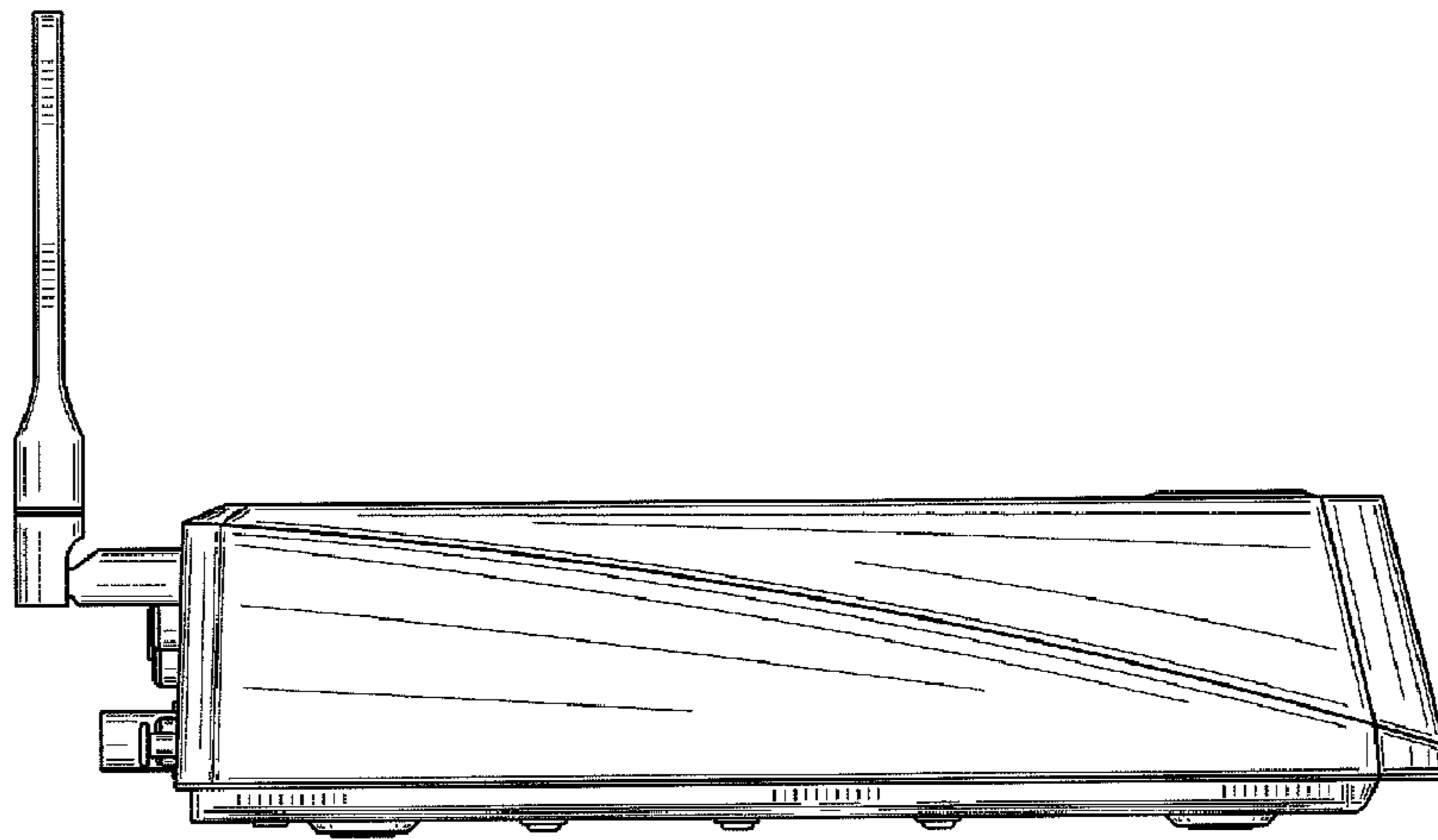

FIG. 5

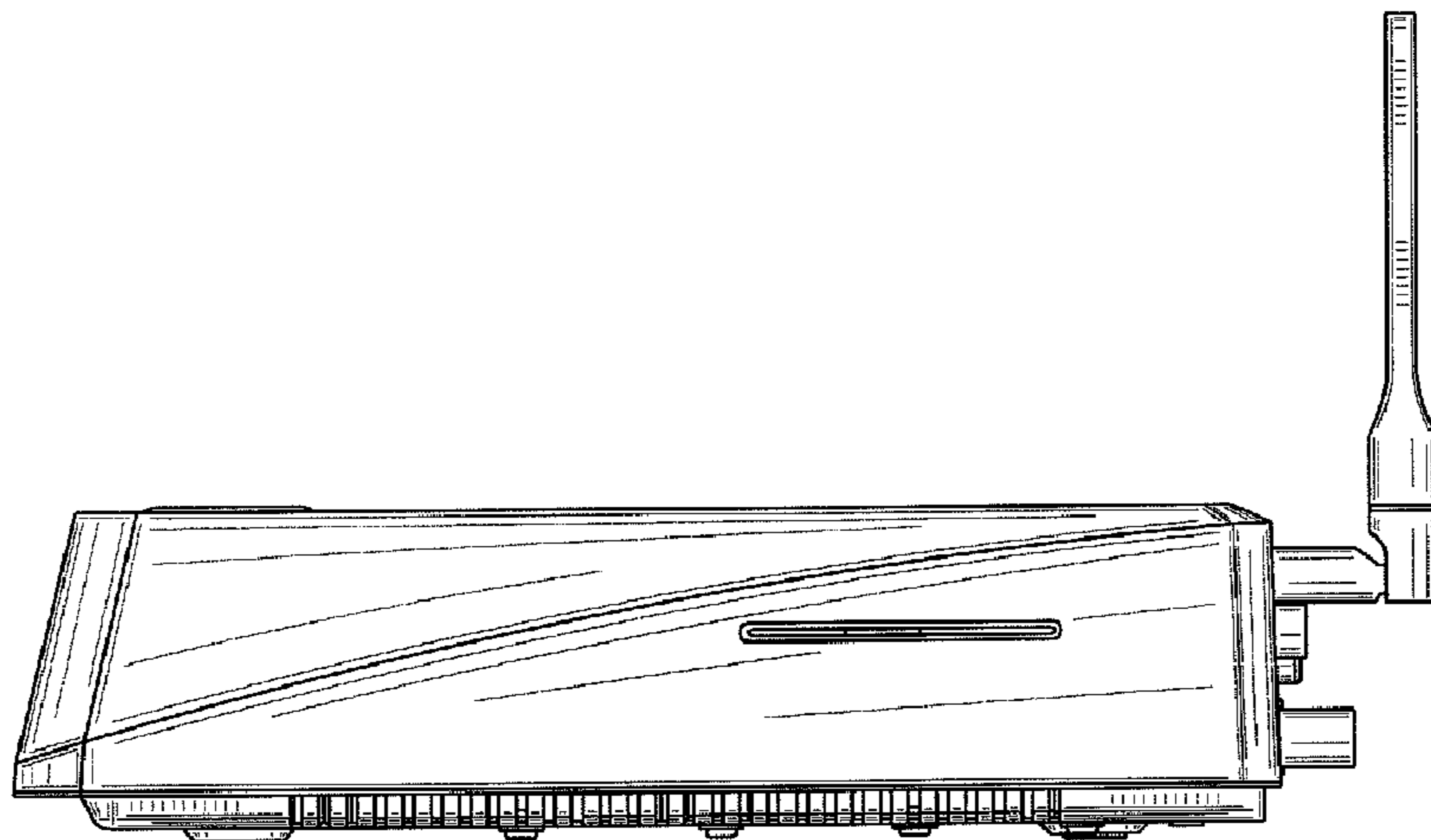

FIG. 6

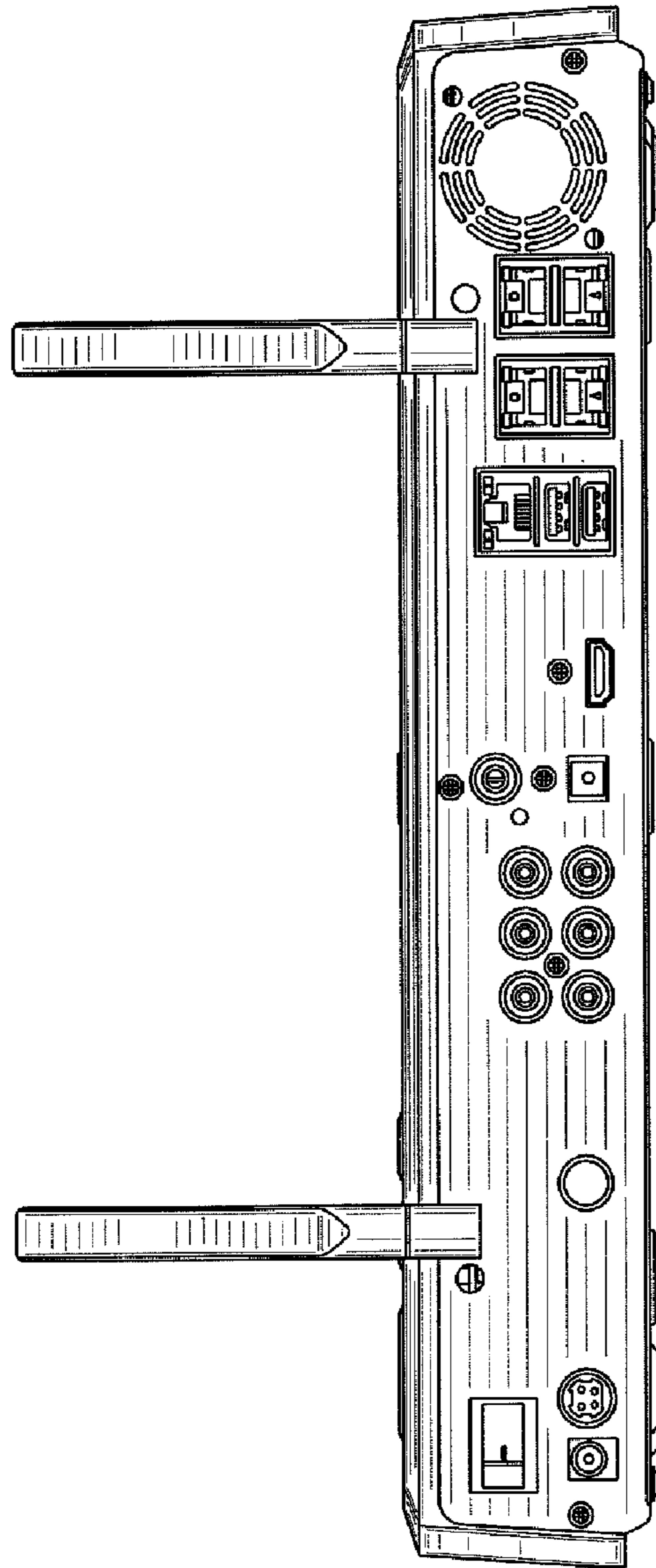

FIG. 7