



US00D673856S

(12) **United States Design Patent**
Snyder

(10) **Patent No.:** **US D673,856 S**
(45) **Date of Patent:** **** Jan. 8, 2013**

- (54) **BOTTLE**
- (75) **Inventor:** **David A. Snyder**, West Chicago, IL (US)
- (73) **Assignee:** **TricorBraun Inc.**, St. Louis, MO (US)
- (**) **Term:** **14 Years**
- (21) **Appl. No.:** **29/404,006**
- (22) **Filed:** **Oct. 13, 2011**
- (51) **LOC (9) Cl.** **09-01**
- (52) **U.S. Cl.** **D9/522; D9/523; D9/530; D9/565;**
D9/569; D9/572
- (58) **Field of Classification Search** D9/682,
D9/687, 690-694, 516, 529, 522-523, 537-544,
D9/546, 549, 552, 556, 559-561, 565, 572-573,
D9/575; 215/381-385
See application file for complete search history.

- D548,095 S * 8/2007 McGuinness D9/573 X
- D549,587 S * 8/2007 Lestelle D9/560
- D566,573 S * 4/2008 Lestelle D9/560
- D598,780 S * 8/2009 Thorman D9/556
- D599,672 S * 9/2009 Carlson et al. D9/542
- D604,164 S * 11/2009 Miller et al. D9/575 X
- D606,412 S * 12/2009 Schwartz et al. D9/561 X
- D619,467 S * 7/2010 Bogosyan D9/561 X
- D620,367 S * 7/2010 Leslie et al. D9/552 X
- D653,954 S * 2/2012 Arad D9/541
- D661,992 S * 6/2012 Brummelhuis et al. D9/529

* cited by examiner

Primary Examiner — Carol P Rademaker
(74) *Attorney, Agent, or Firm* — Husch Blackwell LLP

(57) **CLAIM**
I claim the ornamental design for a bottle, as shown and described.

(56) **References Cited**

U.S. PATENT DOCUMENTS

- D201,998 S * 8/1965 Kirsby D9/522
- D219,204 S * 11/1970 Weiner D9/522
- D341,084 S * 11/1993 Bareiss D9/523 X
- D344,894 S * 3/1994 Bareiss D9/572 X
- D345,306 S * 3/1994 Bareiss D9/529 X
- D371,736 S * 7/1996 Chahed D9/694
- D380,356 S * 7/1997 Husted D9/552 X
- D388,709 S * 1/1998 Weiss D9/529
- D411,458 S * 6/1999 de Baschmakoff D9/544
- D460,697 S * 7/2002 Del Bon D9/565
- D493,364 S * 7/2004 Papiernik D9/687
- D520,374 S * 5/2006 Herrmann et al. D9/561
- D531,050 S * 10/2006 Brandt D9/565 X
- D546,697 S * 7/2007 Schnipper et al. D9/529

DESCRIPTION

FIG. 1 is a top, front, right side perspective view of my new design;
FIG. 2 is a back elevational view thereof;
FIG. 3 is a front elevational view thereof,
FIG. 4 is a right side elevational view thereof;
FIG. 5 is a left side elevational view thereof;
FIG. 6 is a top plan view thereof; and,
FIG. 7 is a bottom plan view thereof.
The broken lines shown in the drawing views are included for the purpose of showing an environmental structure that forms no part of the claimed design.

1 Claim, 6 Drawing Sheets

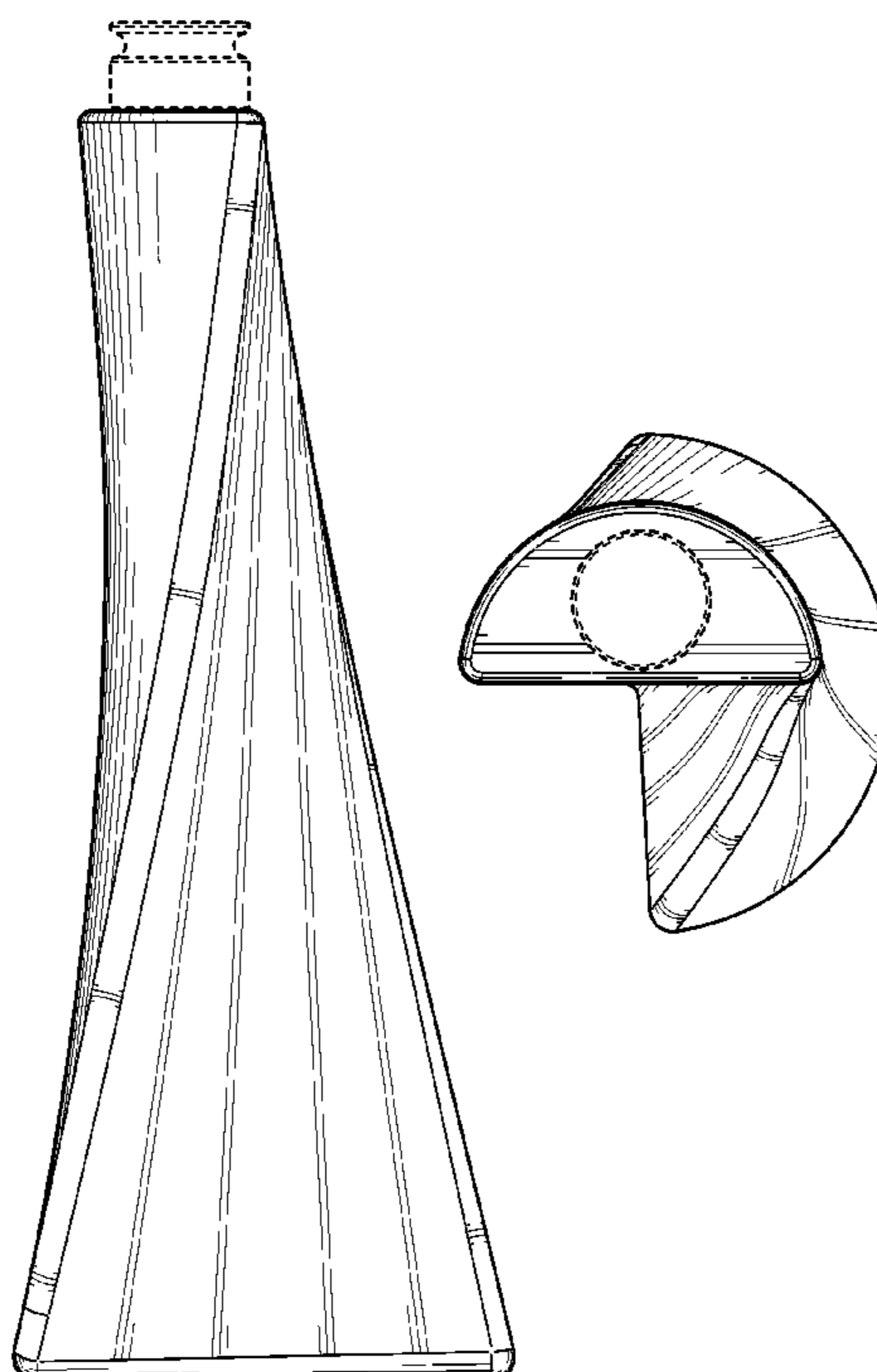

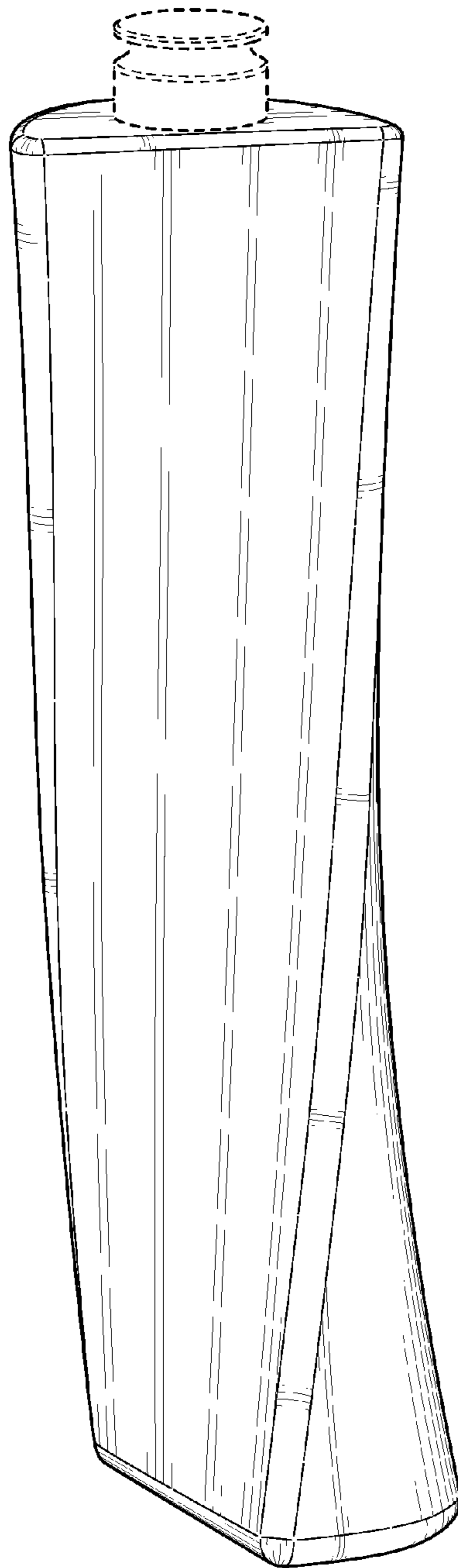

FIG. 1

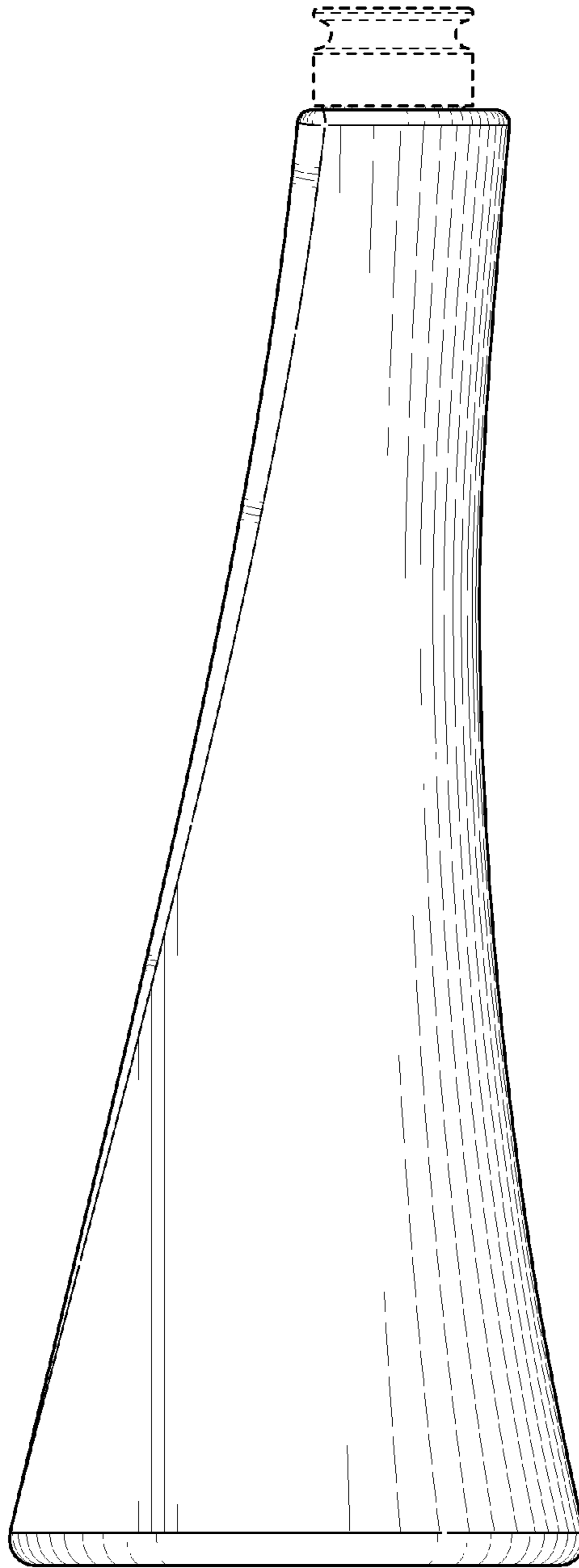

FIG. 2

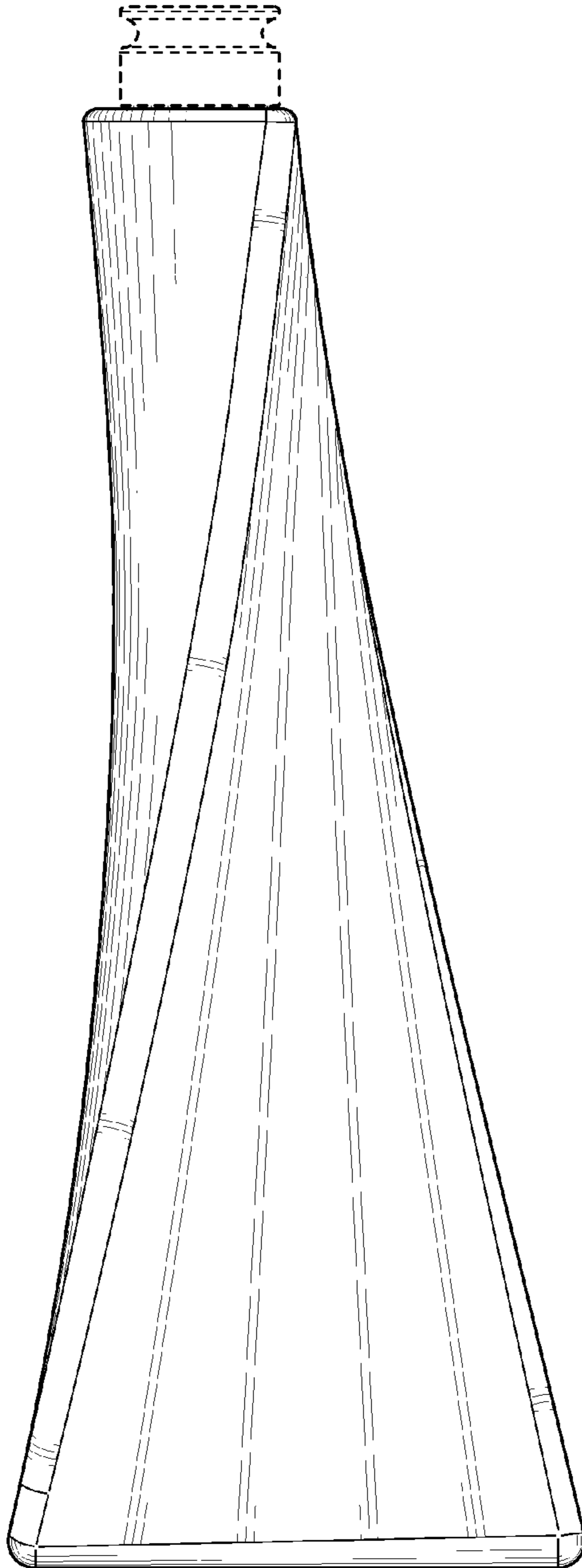

FIG. 3

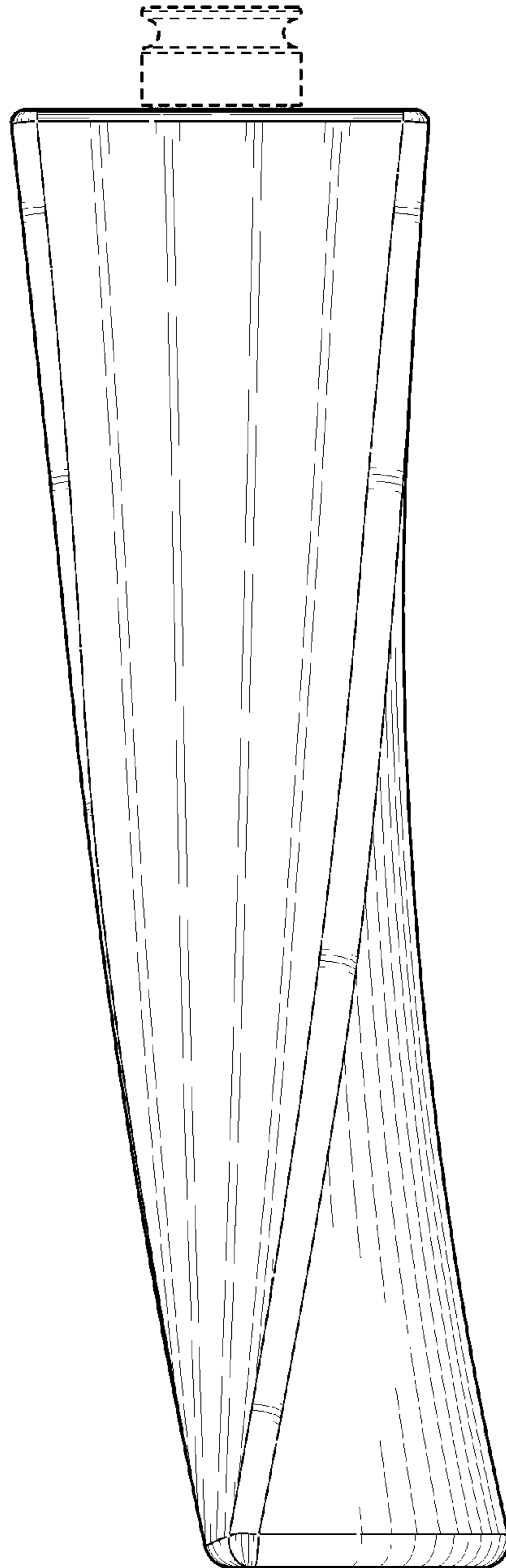

FIG. 4

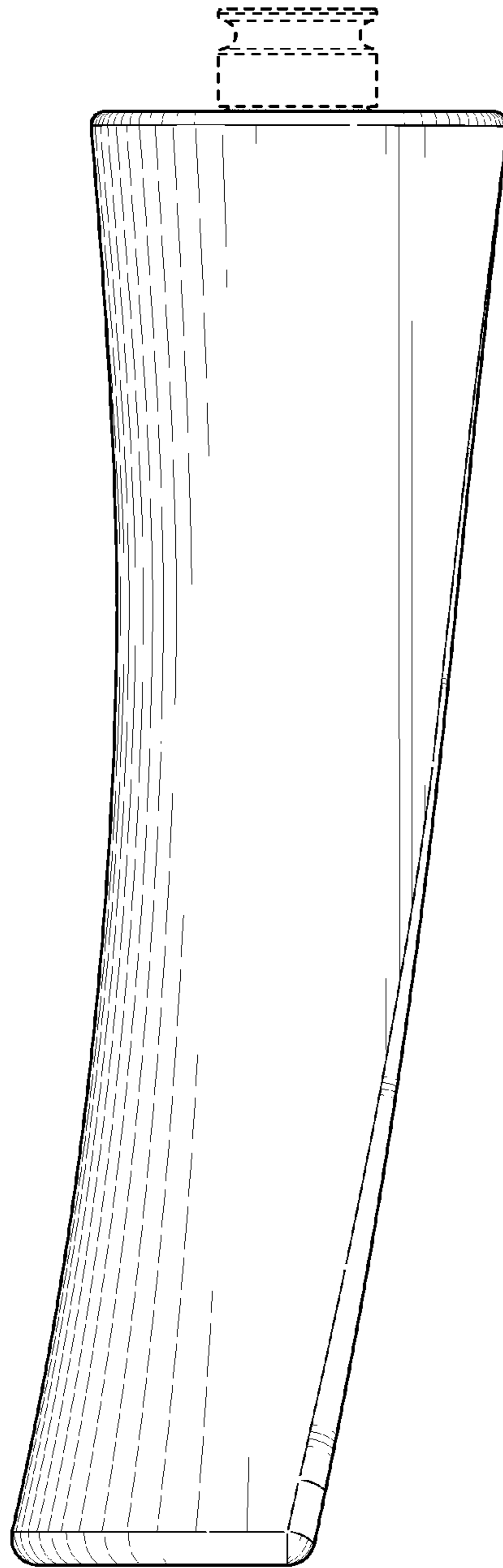

FIG. 5

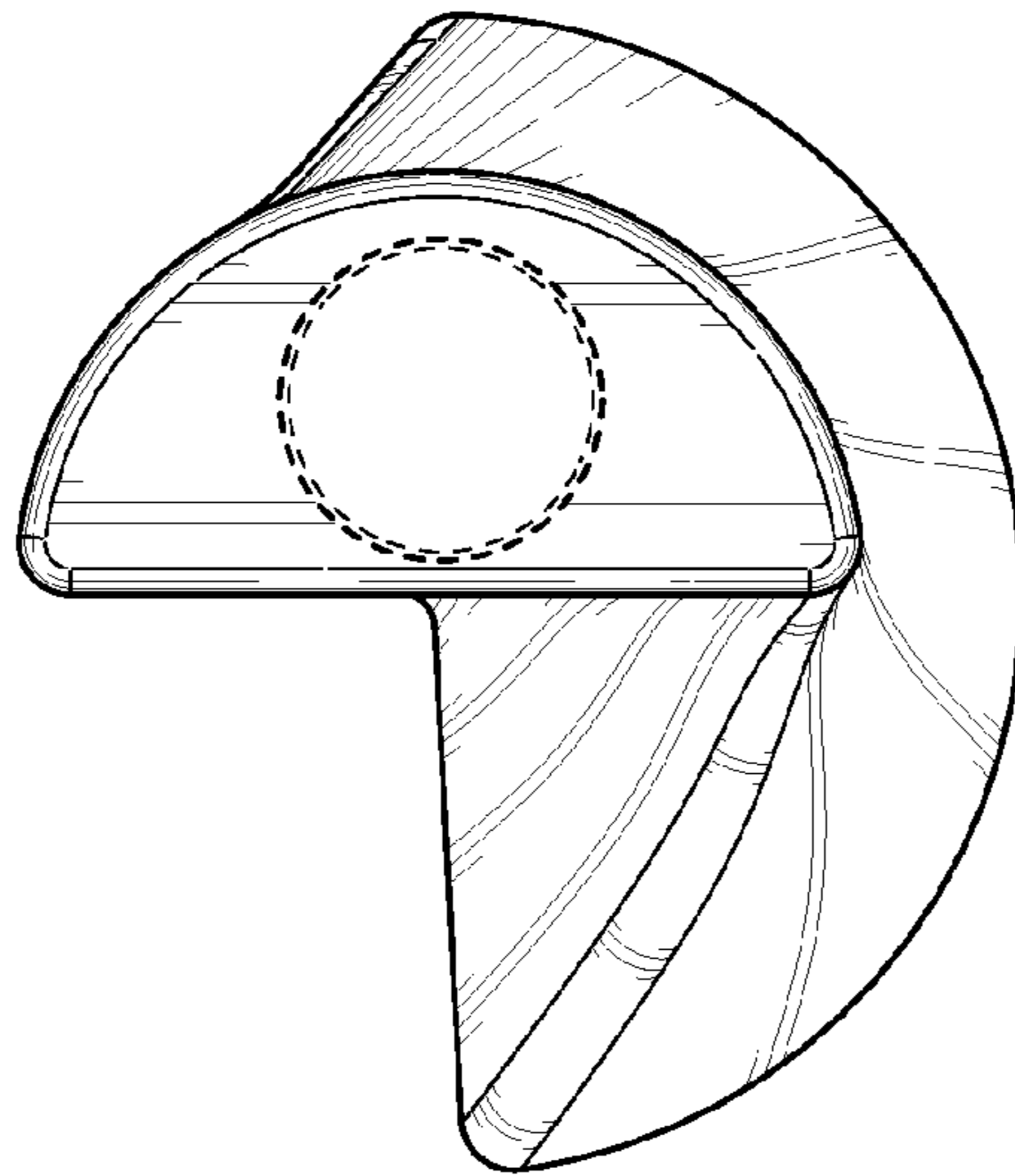

FIG. 6

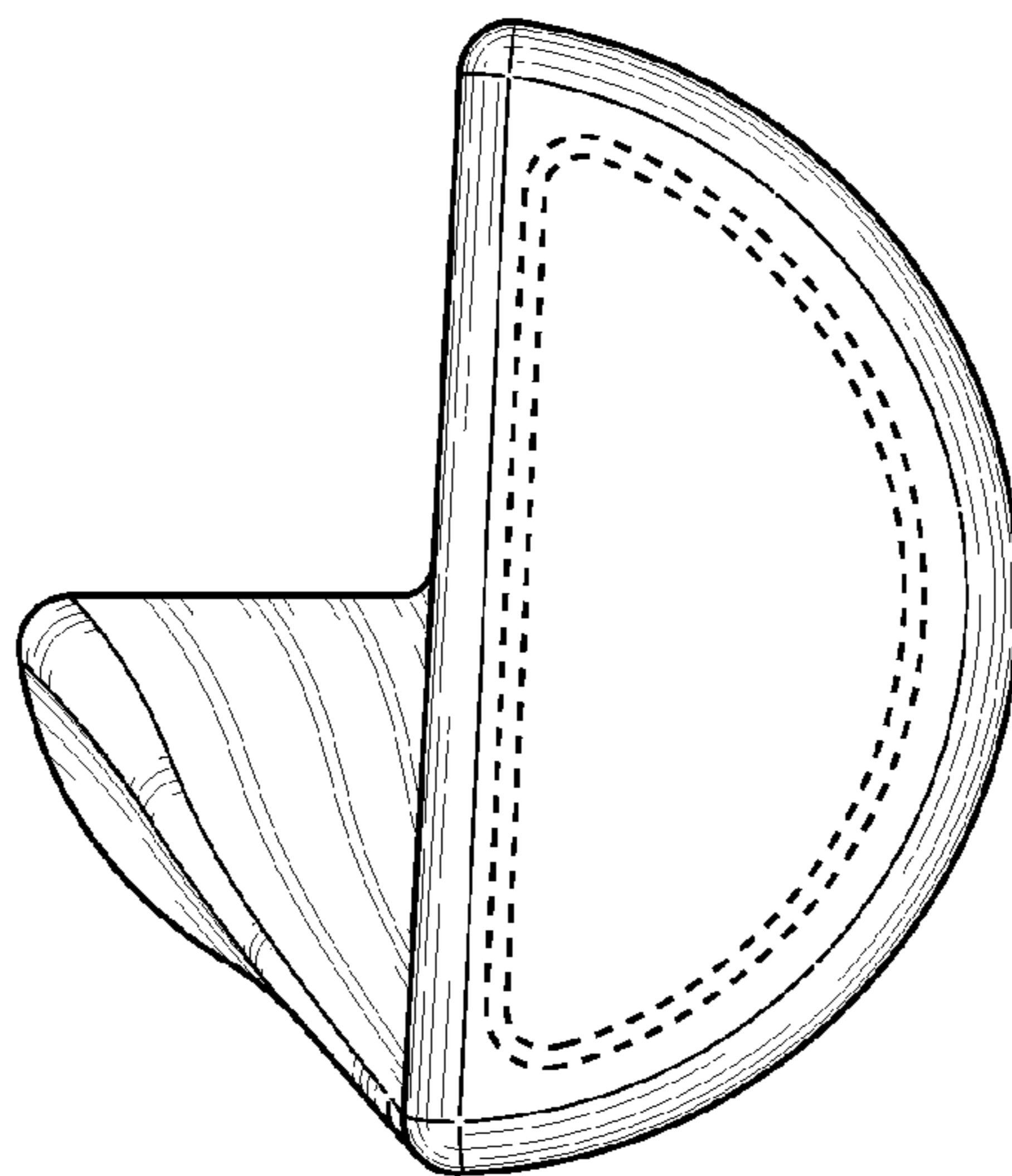

FIG. 7