

US00D673817S

(12) **United States Design Patent**
Wessels

(10) **Patent No.:** **US D673,817 S**
(45) **Date of Patent:** **** Jan. 8, 2013**

(54) **GLASS HOLDER**

(76) Inventor: **Brian Wessels**, Rosemount, MN (US)

(**) Term: **14 Years**

(21) Appl. No.: **29/400,227**

(22) Filed: **Aug. 24, 2011**

(51) **LOC (9) Cl.** **07-06**

(52) **U.S. Cl.** **D7/622**

(58) **Field of Classification Search** D7/601,
D7/602, 619.1, 619.2, 620, 621, 622, 623,
D7/624.1, 624.2, 624.3, 625, 387, 701, 707;
215/392, 393, 394, 395, 396, 397, 398, 399;
220/737, 738, 739, 742, 743, 760, 769, 773;
294/27.1, 29, 32, 33, 137

See application file for complete search history.

(56) **References Cited**

U.S. PATENT DOCUMENTS

556,337	A	*	3/1896	Dawes	248/145.6
D37,943	S	*	4/1906	Conlin	D7/622
1,353,282	A	*	9/1920	Shrauger	294/169
D59,662	S		11/1921	Lauzon		
2,733,845	A		2/1956	Biro		
D187,247	S	*	2/1960	Tupper	D7/622
D217,828	S	*	6/1970	Hillard	D7/622
D227,043	S		5/1973	Van Den Berg		
D279,250	S	*	6/1985	Holloway	D7/507
D304,143	S		10/1989	Dennis		
D347,734	S		6/1994	Patterson et al.		
D349,190	S		8/1994	Wasserman		
D350,024	S		8/1994	Ryker		
D375,229	S	*	11/1996	DiBella	D7/619.1
5,622,292	A		4/1997	Dorney		
D388,604	S		1/1998	Castro		
5,782,390	A		7/1998	Dorney		
D397,550	S		9/1998	Coughlin		
D458,799	S	*	6/2002	Andujar	D7/388
D479,956	S		9/2003	Bellander		
D487,967	S		4/2004	Kodsi et al.		
D492,161	S	*	6/2004	Kaller et al.	D7/622
D511,438	S		11/2005	Johnson		
D554,856	S		11/2007	Clanton		
D555,897	S		11/2007	Pietraroia		
D590,714	S	*	4/2009	Sanders	D9/455

D623,023	S	*	9/2010	Proano	D7/622
D624,366	S		9/2010	Sherron		
D625,513	S		10/2010	Carnes et al.		
D632,908	S		2/2011	Tincher		
D635,407	S	*	4/2011	Ceder	D7/622
D642,432	S		8/2011	Williams		

OTHER PUBLICATIONS

Wine Glass Holder Necklace—Set of 2, <http://www.giftedgrape.com/wineglassholdernecklace.aspx>, publicly available at least one year prior to Aug. 24, 2011, 2 pages.

Wine Holder Styles, www.handsfreewine.com, publicly available since Feb. 2010, 1 page.

Mobile Grape™ Product Information, <http://www.mobilegrape.com/productinfo.html>, publicly available at least one year prior to Aug. 24, 2011, 3 pages.

(Continued)

Primary Examiner — Elizabeth J Oswecki

(74) *Attorney, Agent, or Firm* — Griffiths & Seaton PLLC

(57) **CLAIM**

The ornamental design for a glass holder, as shown and described.

DESCRIPTION

FIG. 1 is a rear, perspective view of a glass holder showing our new design;

FIG. 2 is a rear view thereof;

FIG. 3 is a front view thereof;

FIG. 4 is a right side view thereof;

FIG. 5 is a left side view thereof;

FIG. 6 is a top view thereof;

FIG. 7 is a bottom view thereof;

FIG. 8 is a rear, perspective view of the glass holder of FIG. 1 with portions of the environmental subject matter removed to clearly illustrate the claimed design;

FIG. 9 is a rear view thereof;

FIG. 10 is a front view thereof;

FIG. 11 is a right side view thereof;

FIG. 12 is a left side view thereof;

FIG. 13 is a top view thereof; and,

FIG. 14 is a bottom view thereof.

The features shown in broken lines depict environmental subject matter only and form no part of the claimed design.

1 Claim, 12 Drawing Sheets

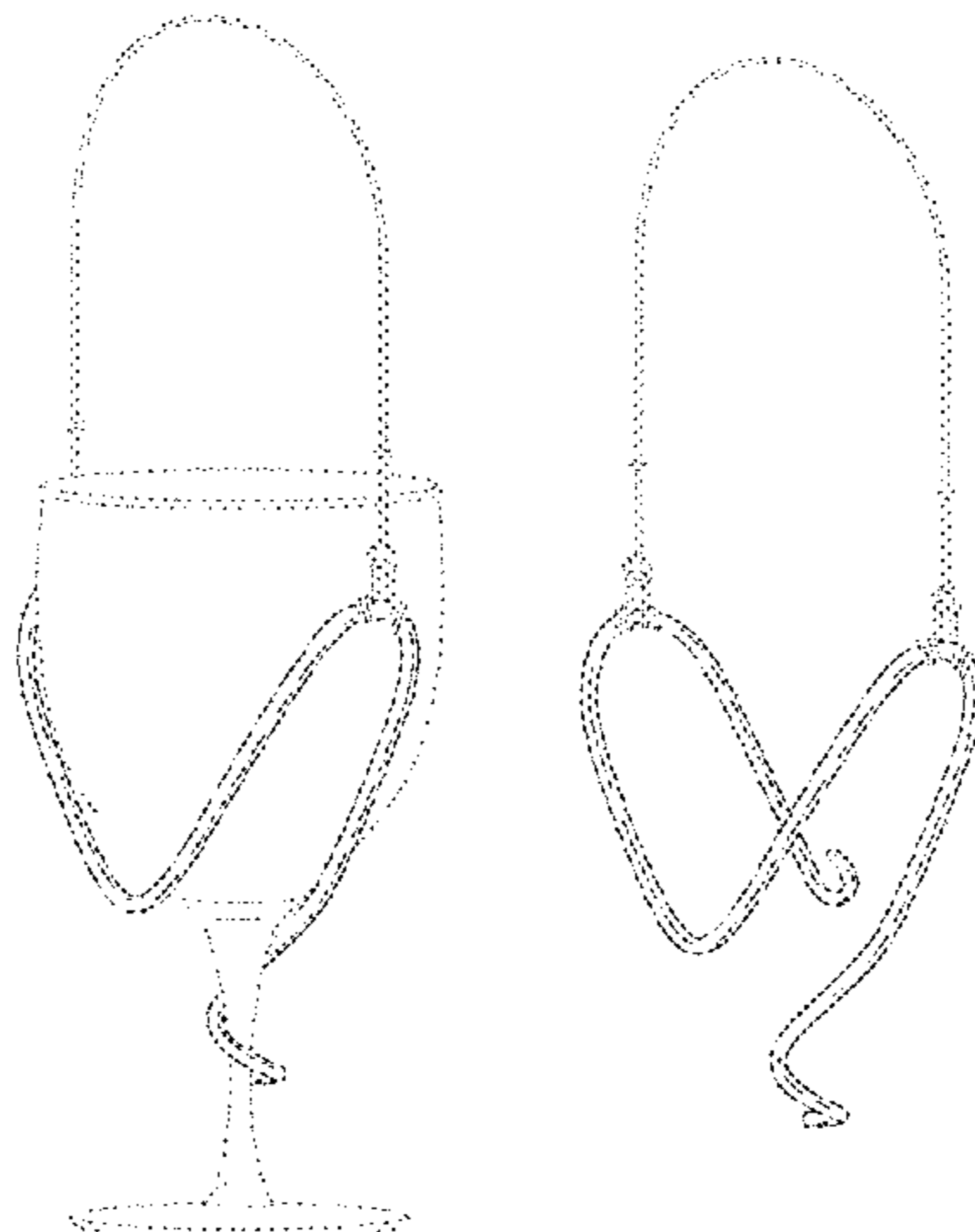

OTHER PUBLICATIONS

Wine Glass Necklaces, <http://www.watsonsports.com/wineglassnecklace.htm>, publicly available at least one year prior to Aug. 24, 2011, 3 pages.

Wine Glass Holder Necklace (Set of 2), [www.wineenthusiast.com/wine-glass-holder-necklace-\(set-of-2\).asp](http://www.wineenthusiast.com/wine-glass-holder-necklace-(set-of-2).asp), publicly available at least one year prior to Aug. 24, 2011, 2 pages.

* cited by examiner

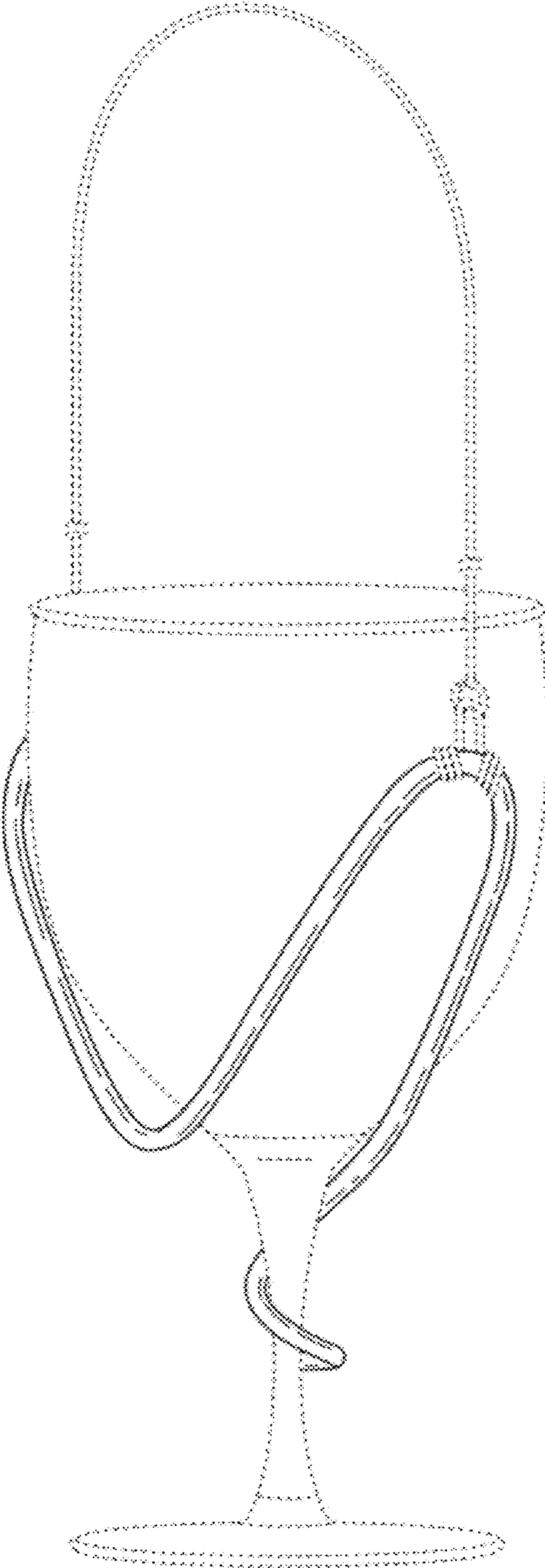

FIG. 1

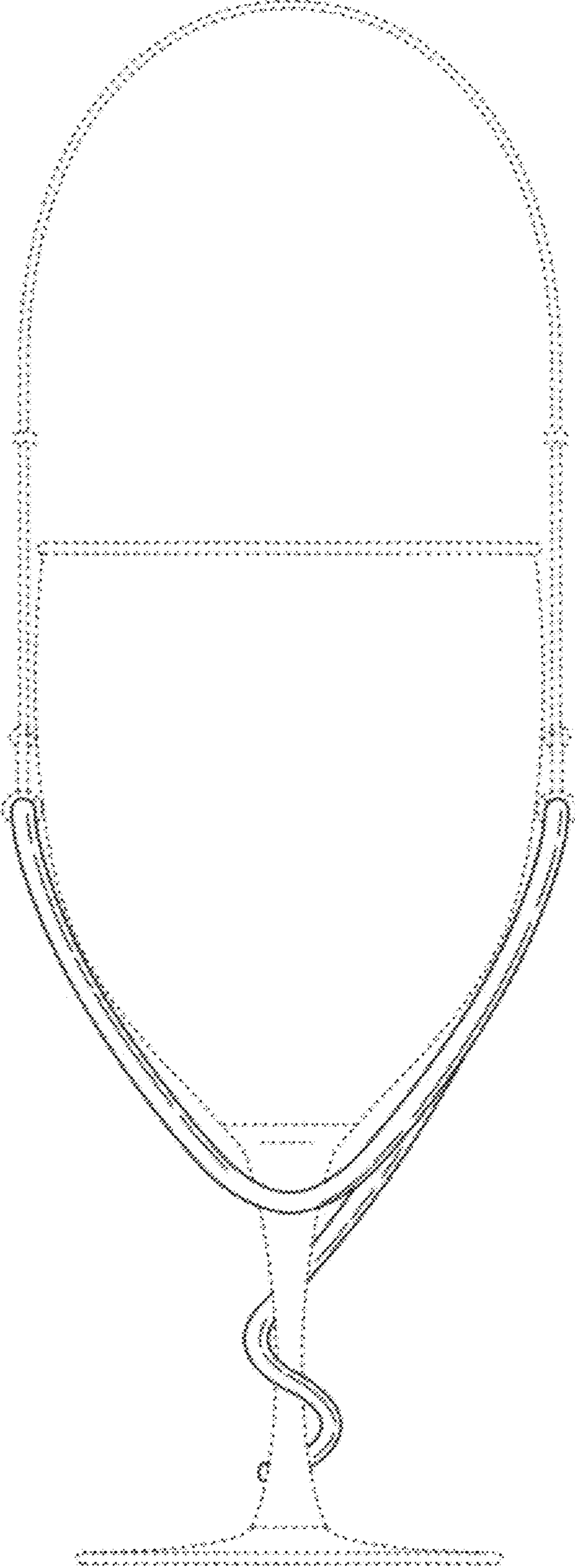

FIG. 2

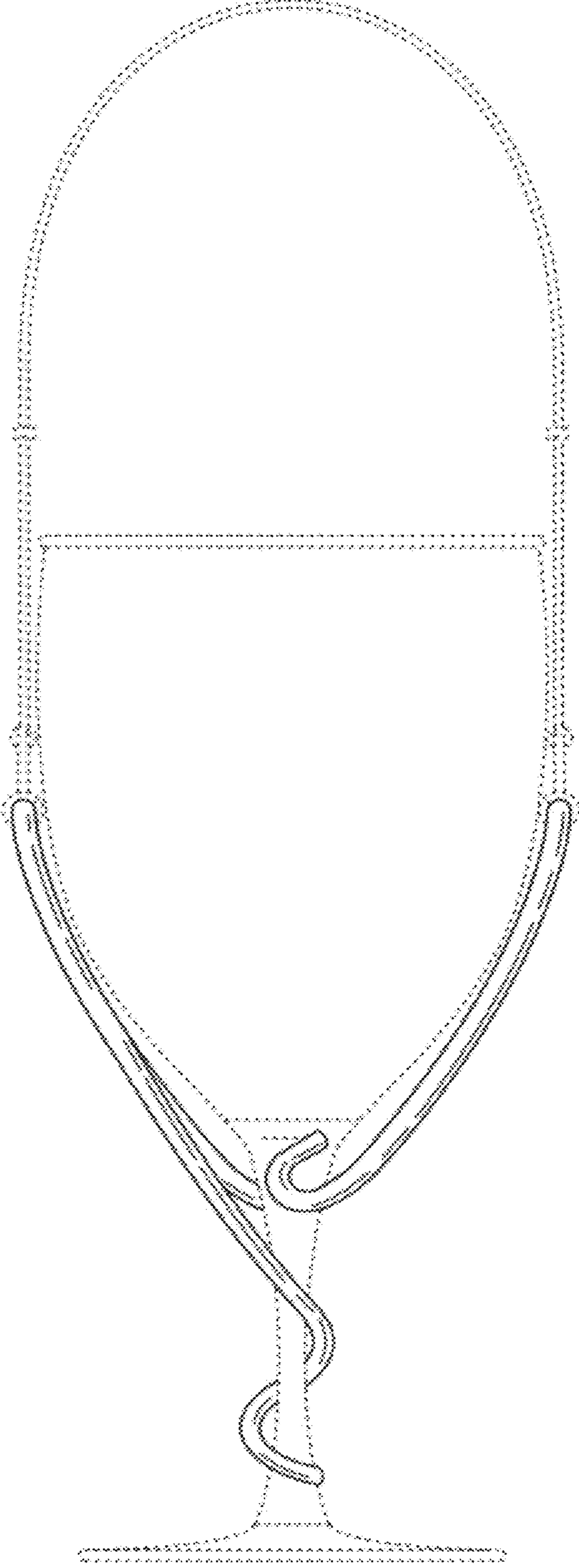

FIG. 3

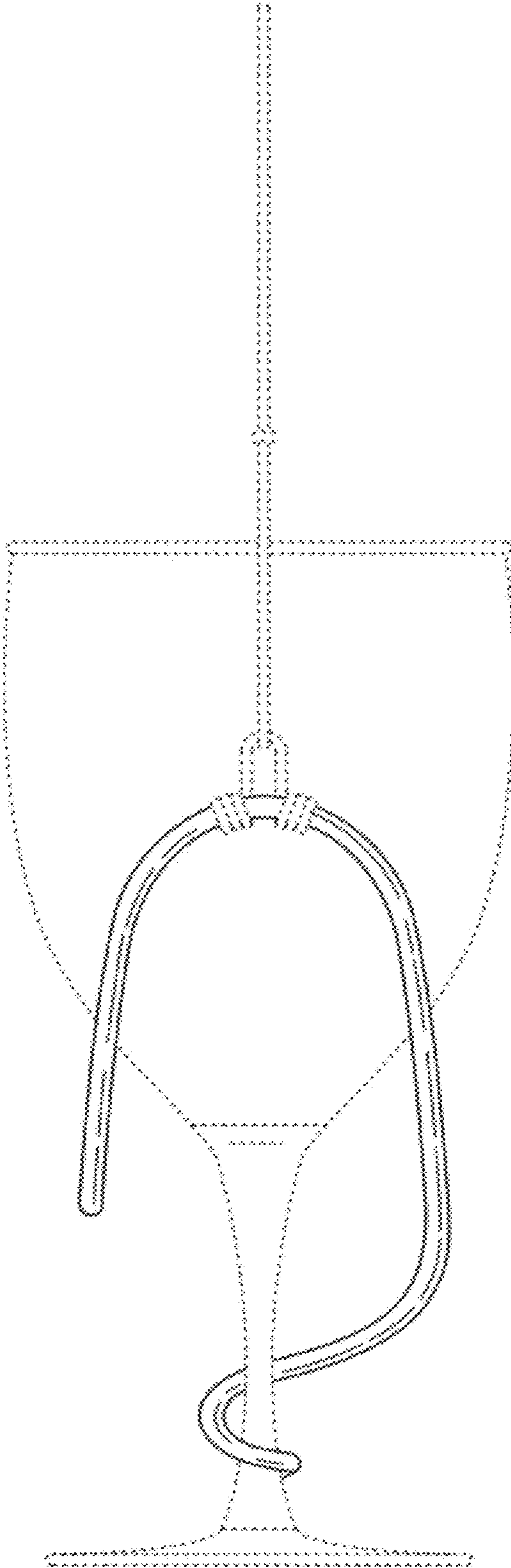

FIG. 4

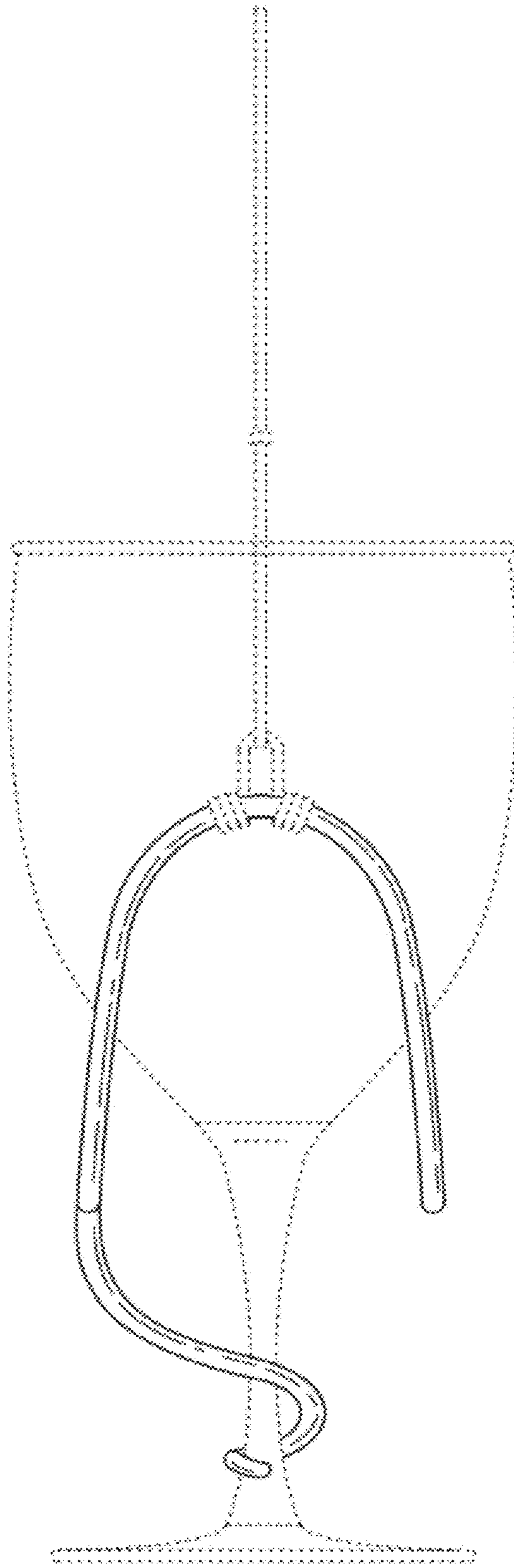

FIG. 5

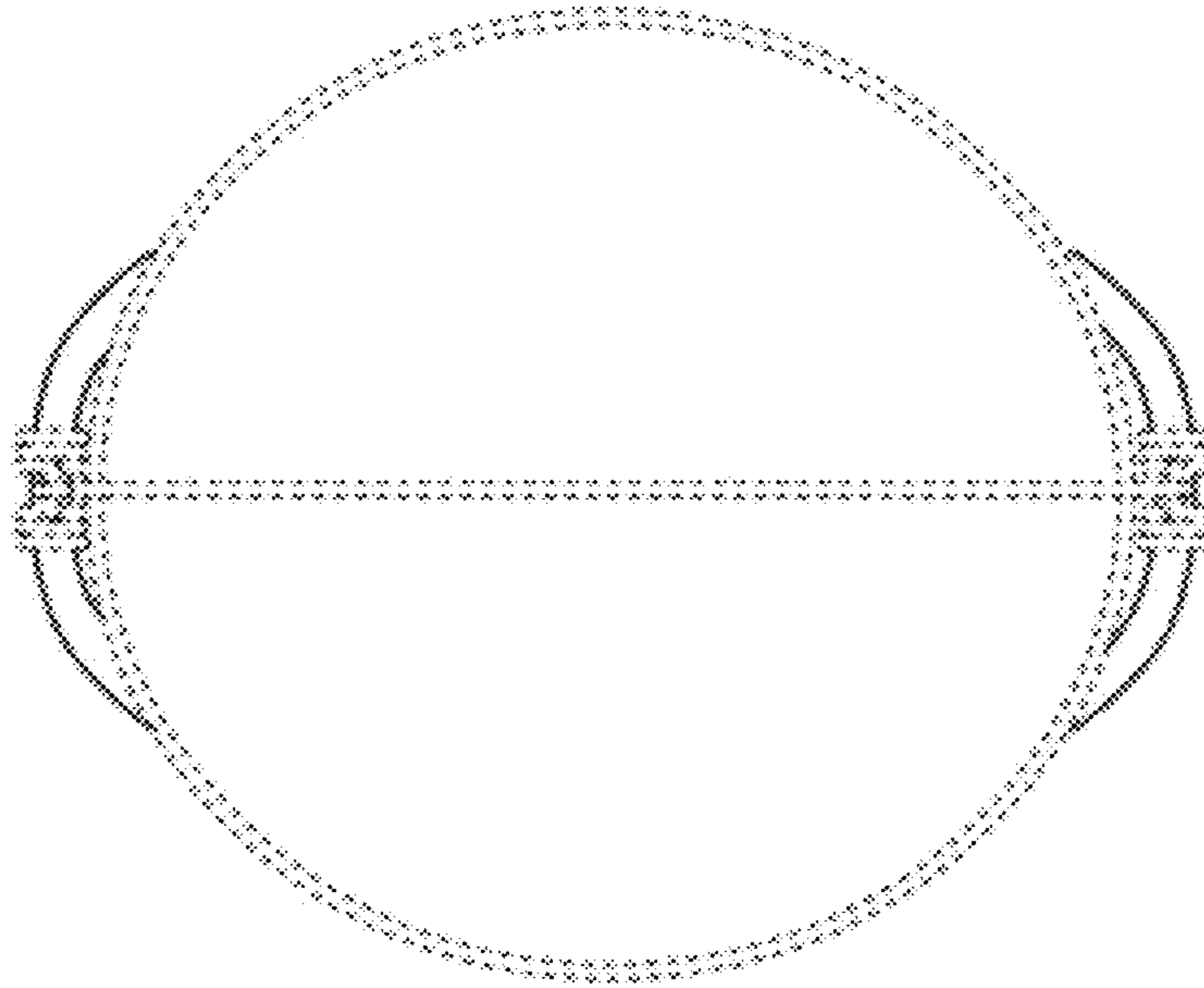

FIG. 6

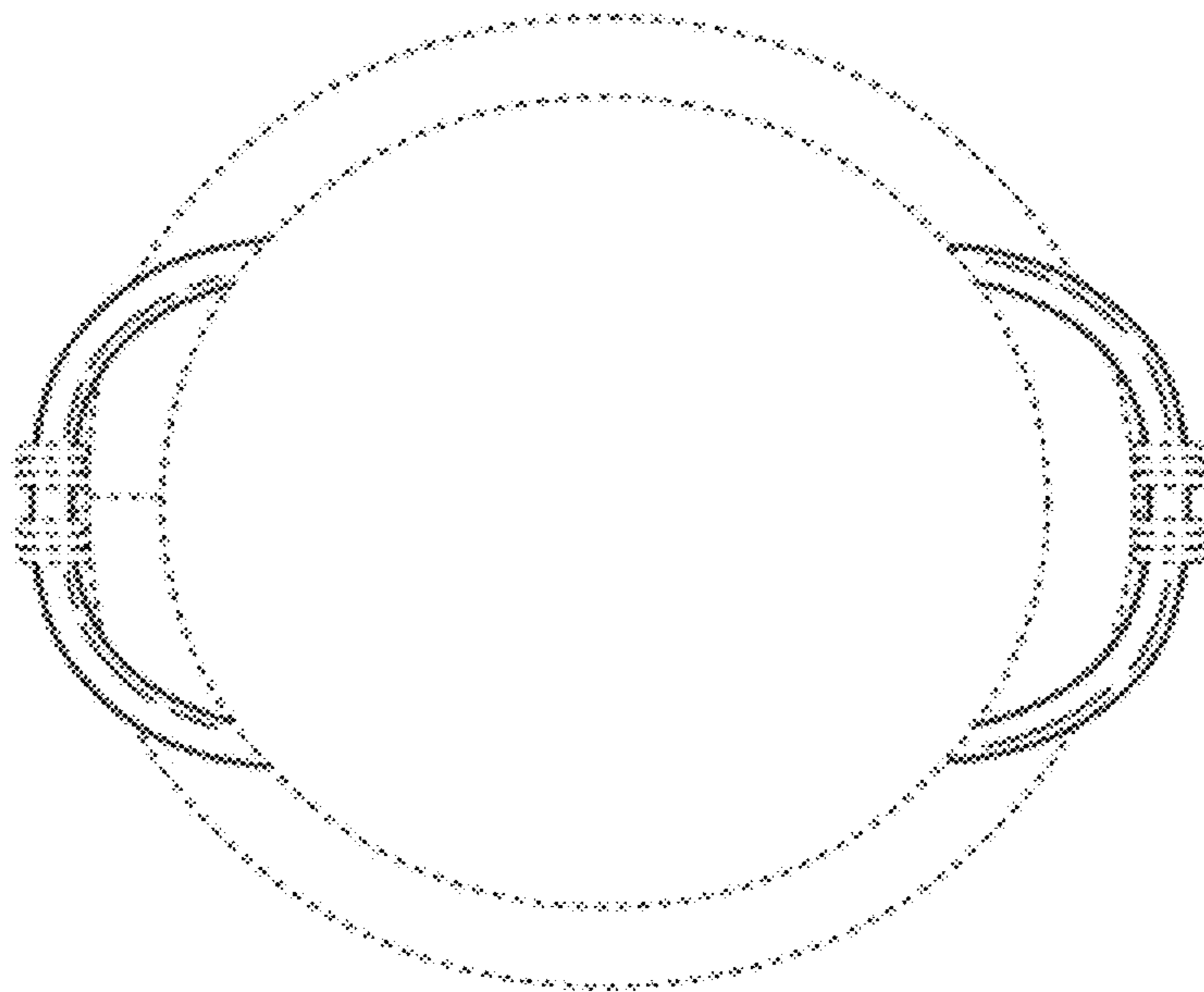

FIG. 7

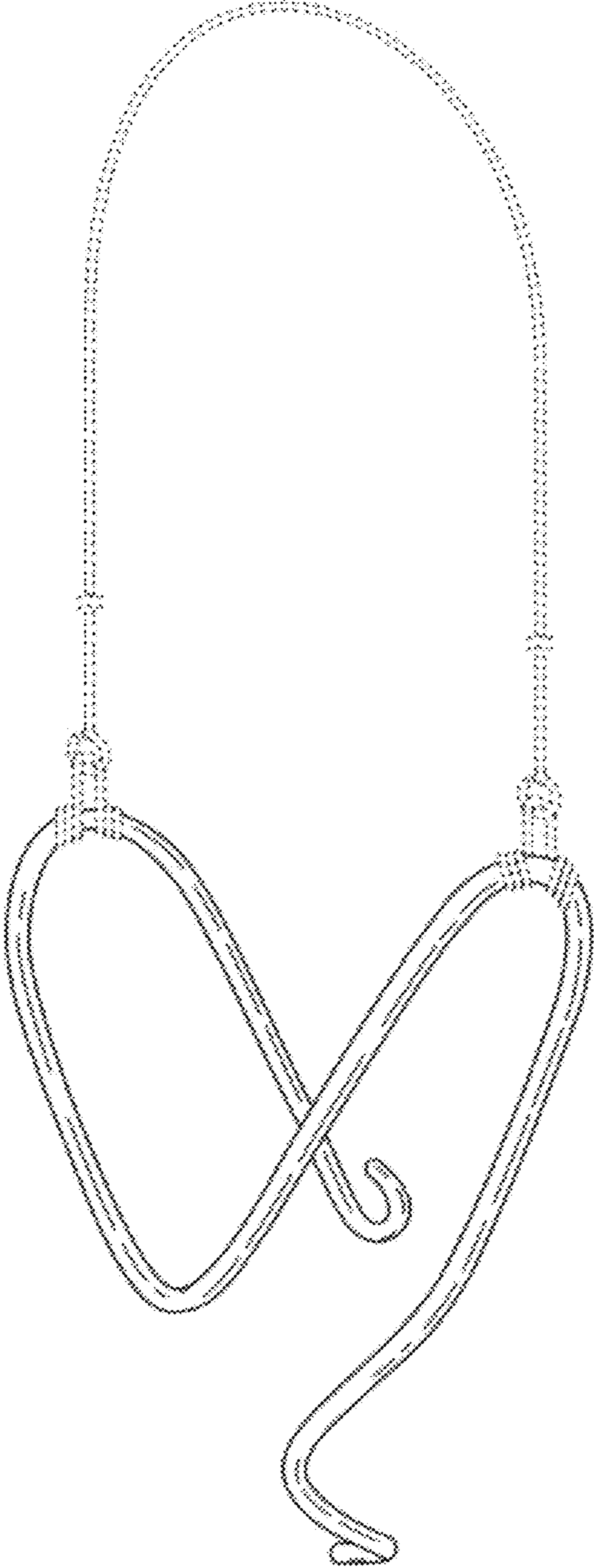

FIG. 8

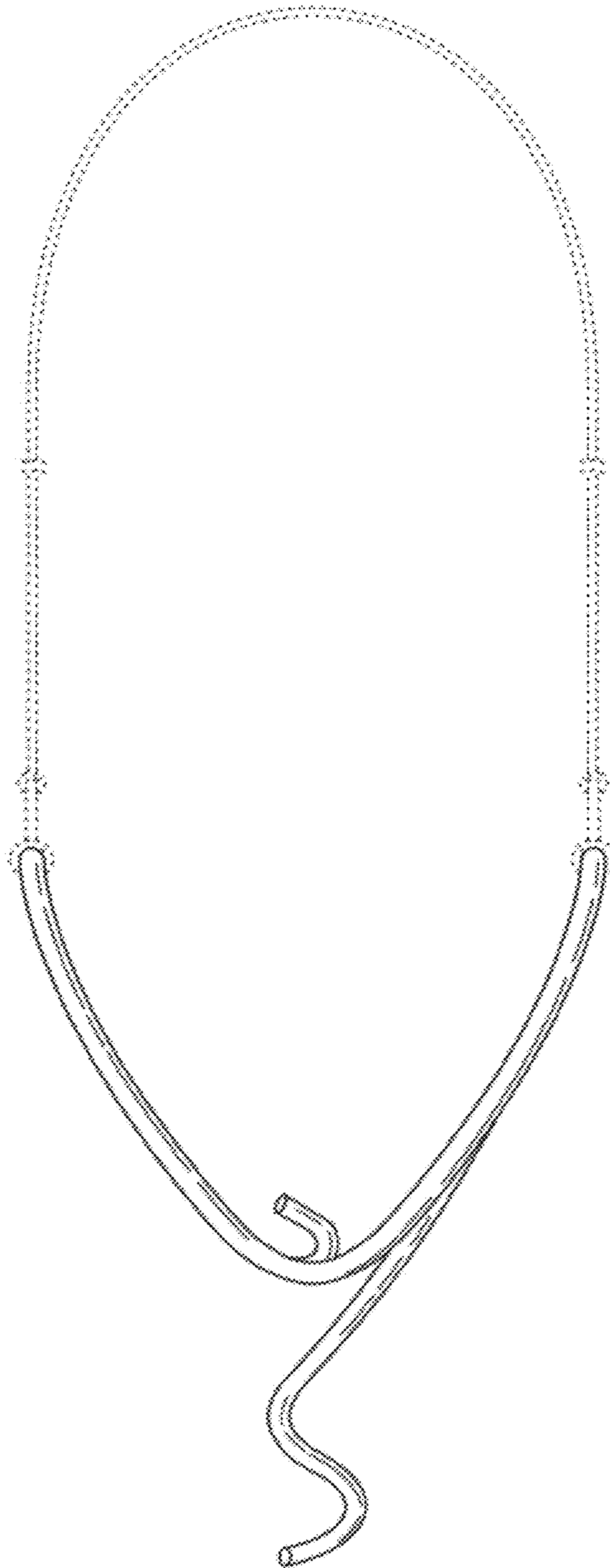

FIG. 9

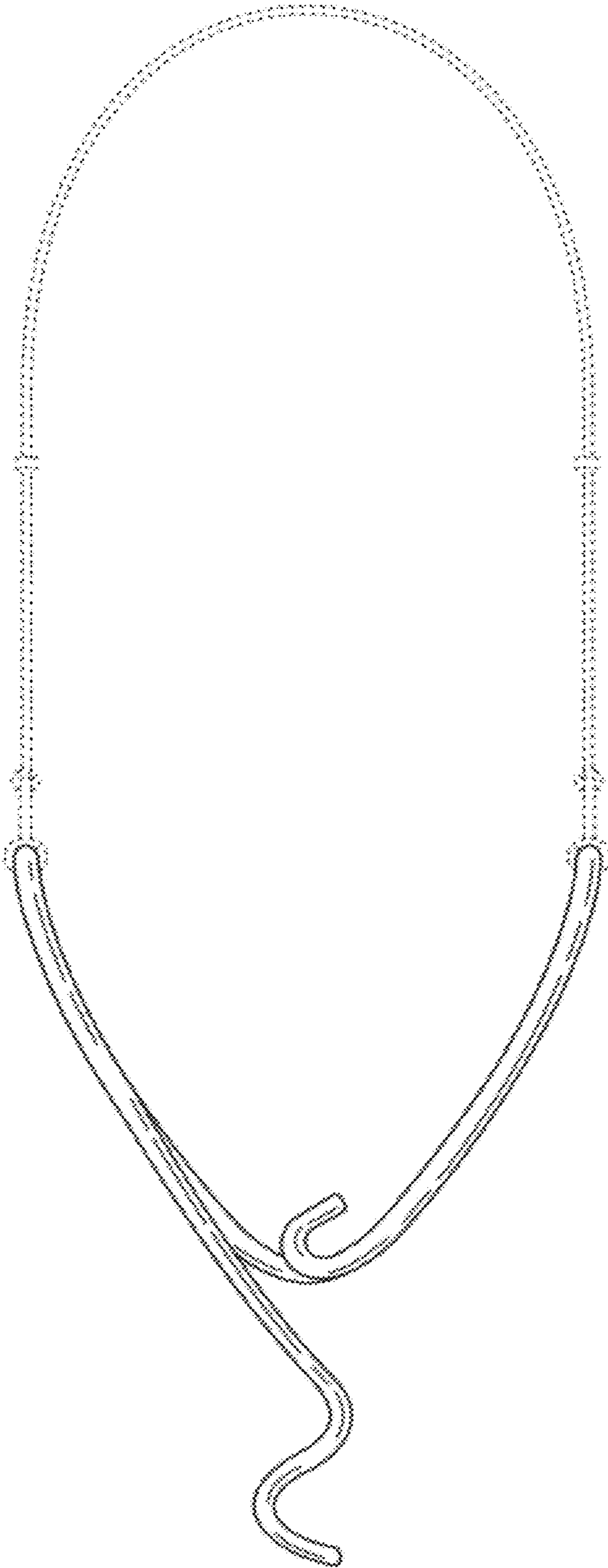

FIG. 10

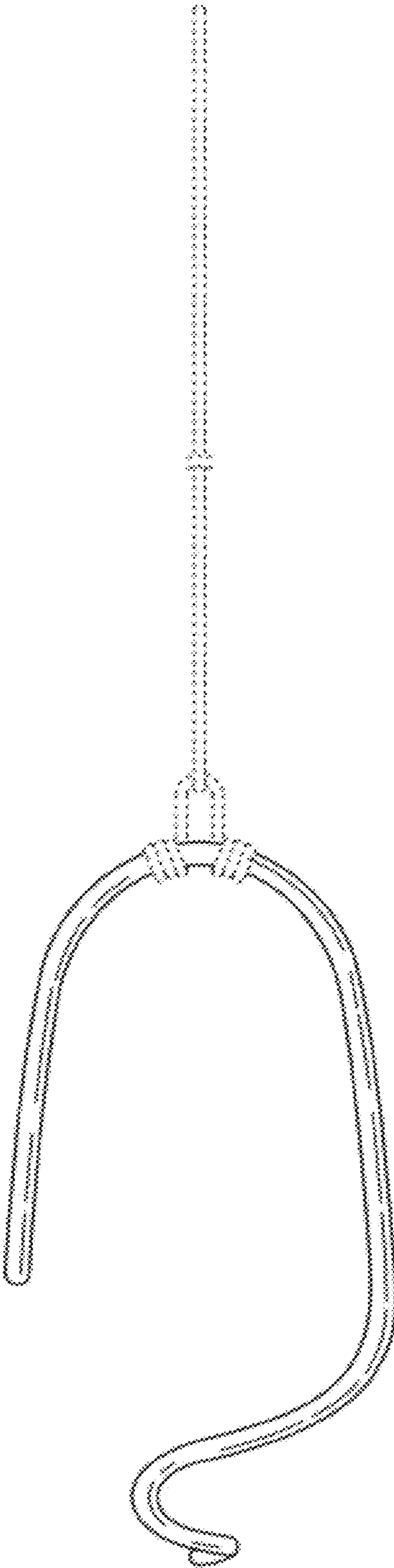

FIG. 11

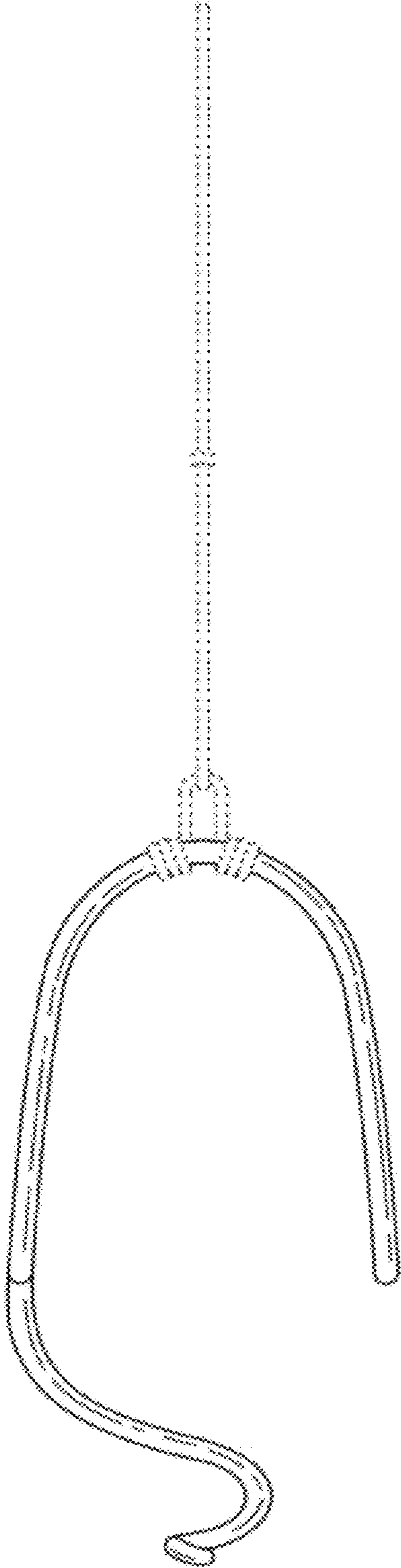

FIG. 12

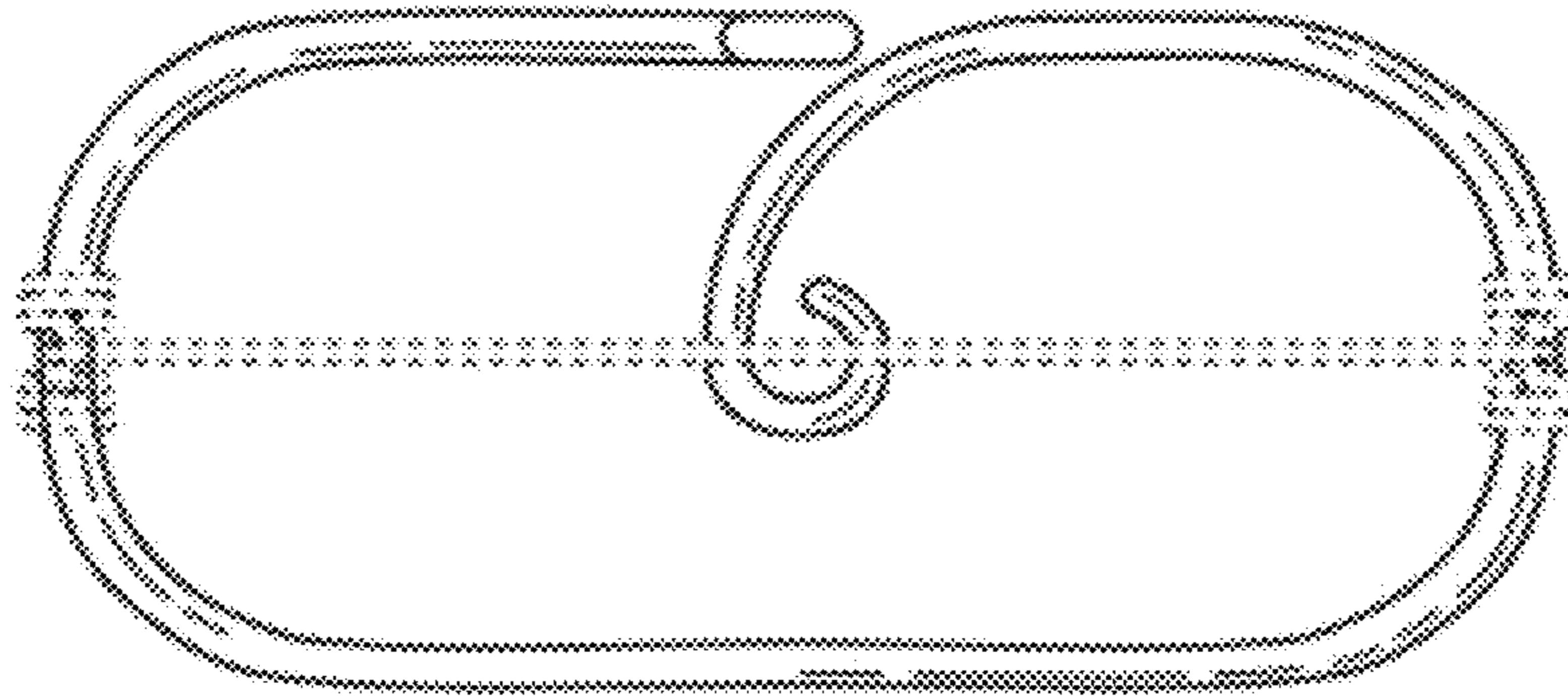

FIG. 13

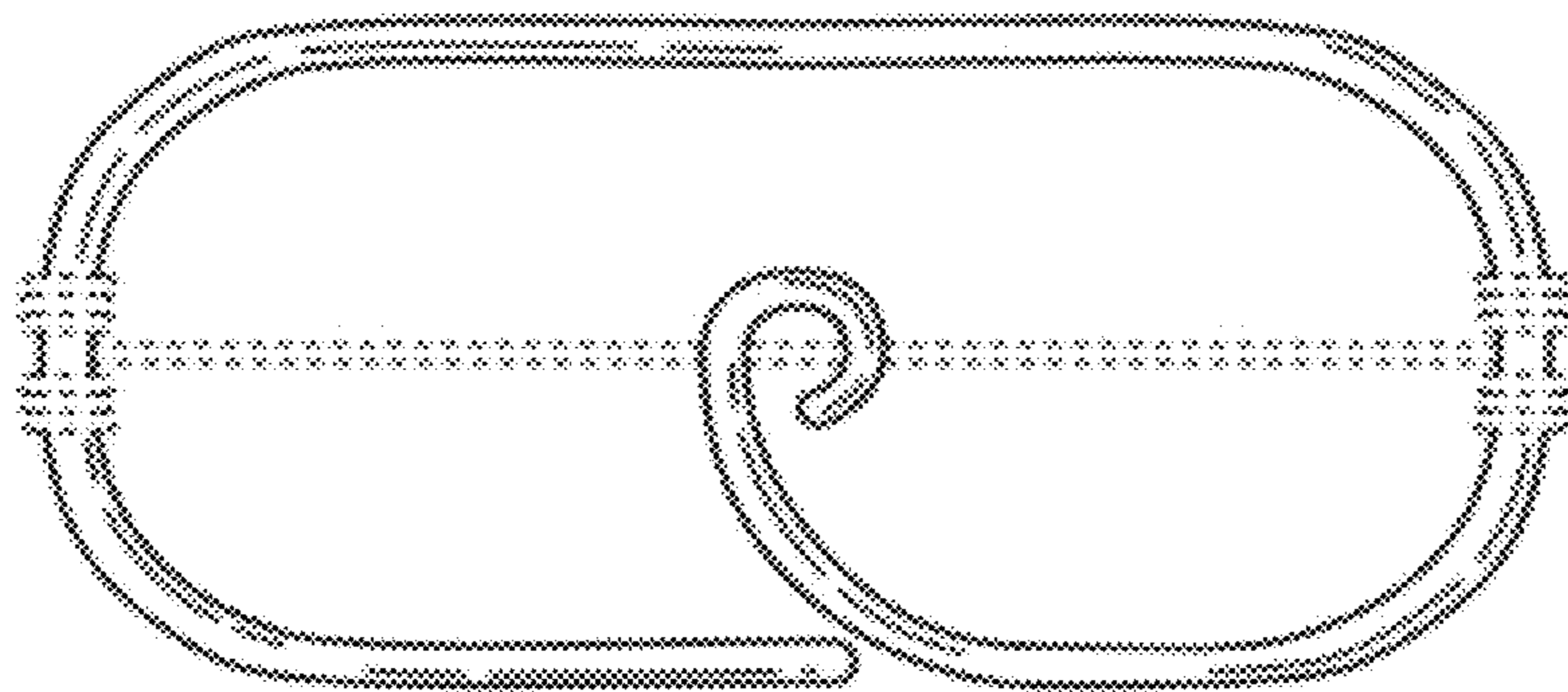

FIG. 14