



US00D673769S

(12) **United States Design Patent**
Gorman

(10) **Patent No.:** **US D673,769 S**
(45) **Date of Patent:** **** Jan. 8, 2013**

(54) **PORTABLE MEDICATION ORGANIZER**

(76) Inventor: **Sara Gorman**, Alexandria, VA (US)

(**) Term: **14 Years**

(21) Appl. No.: **29/414,739**

(22) Filed: **Mar. 2, 2012**

(51) **LOC (9) Cl.** **03-01**

(52) **U.S. Cl.** **D3/203.3; D3/299**

(58) **Field of Classification Search** D3/203.1–203.8,
D3/201, 205, 299, 303, 315, 283–291; 206/528–540,
206/363, 438, 473, 570–571; 190/11–112,
190/115, 118, 902–903; 383/4, 37
See application file for complete search history.

(56) **References Cited**

U.S. PATENT DOCUMENTS

D526,118 S *	8/2006	Foote	D3/203.1
D641,547 S *	7/2011	Coleman	D3/203.3
D646,485 S *	10/2011	Mason	D3/299
D658,361 S *	5/2012	Kontos	D3/203.1

OTHER PUBLICATIONS

Dr. Root's Medminders, "Our products", available at <http://shop.drrootsmedminders.com/main.sc> (first visited Jan. 11, 2012).
Atlier De Soyun, "Travel Bag Notion Pouch Organizer Craft Bag Organizational Solution in Tweed Pink," available at <http://www.etsy.com/listing/68836586/travel-bag-notion-pouch-organizer-craft> (Feb. 1, 2012).

Everything Mary, Photographs of Bead Storage Fold Up, seen on sale at Michaels Stores on Feb. 2, 2012.

* cited by examiner

Primary Examiner — Catheri Oliver-Garcia

(74) *Attorney, Agent, or Firm* — MH2 Technology Law Group

(57) **CLAIM**

The ornamental design for a portable medication organizer, as shown and described.

DESCRIPTION

FIG. 1 is a perspective view of the portable medication organizer.

FIG. 2 is a front elevational view of the portable medication organizer;

FIG. 3 is a rear elevational view of the portable medication organizer;

FIG. 4 is a left side view of the portable medication organizer;

FIG. 5 is a right side view of the portable medication organizer;

FIG. 6 is a top view of the portable medication organizer.

FIG. 7 is a bottom view of the portable medication organizer.

FIG. 8 is a perspective view of the portable medication organizer with the bottom third folded towards the middle; and,

FIG. 9 is a perspective view of the portable medication organizer completely folded.

The broken lines in the drawings represent stitching.

1 Claim, 7 Drawing Sheets

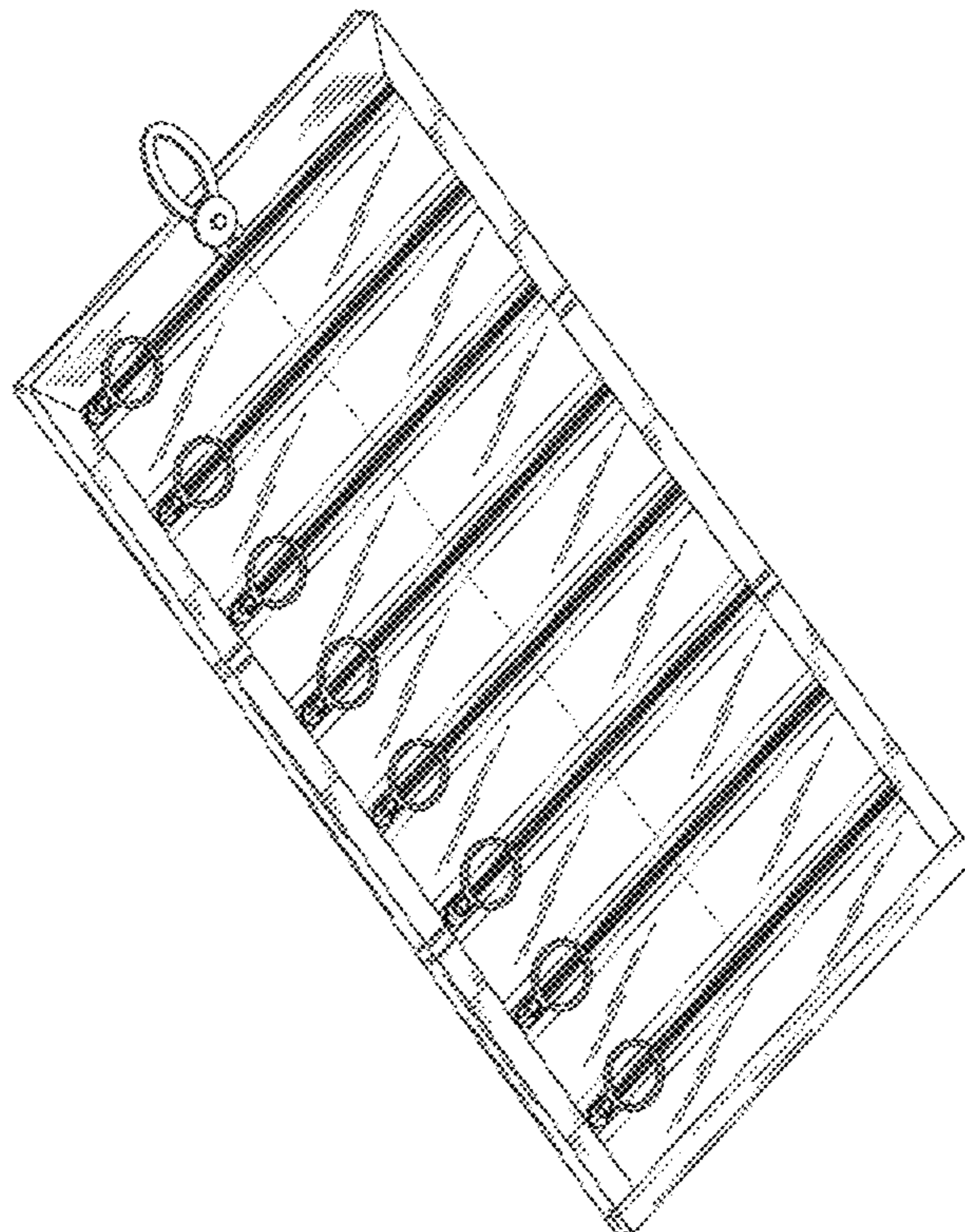

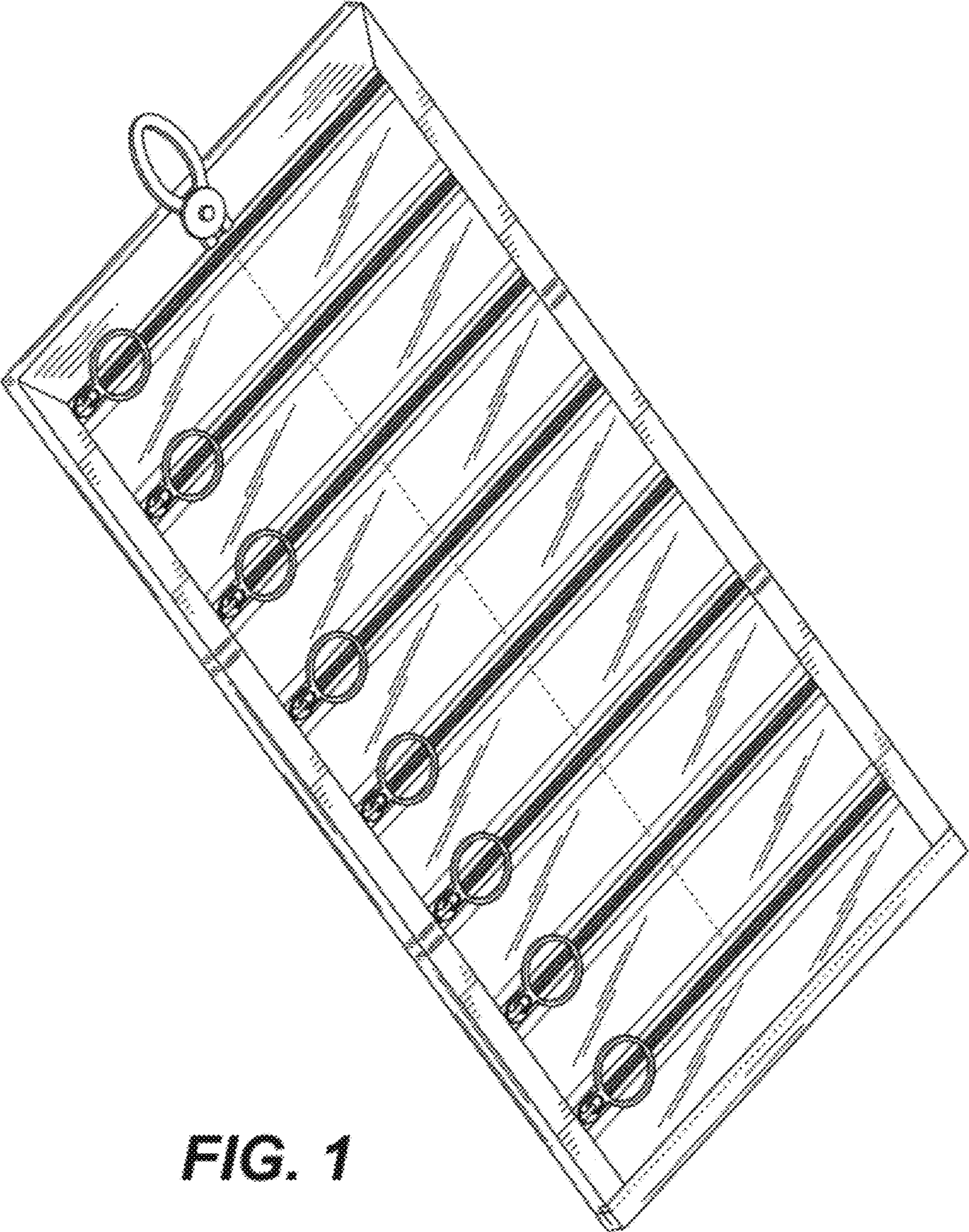

FIG. 1

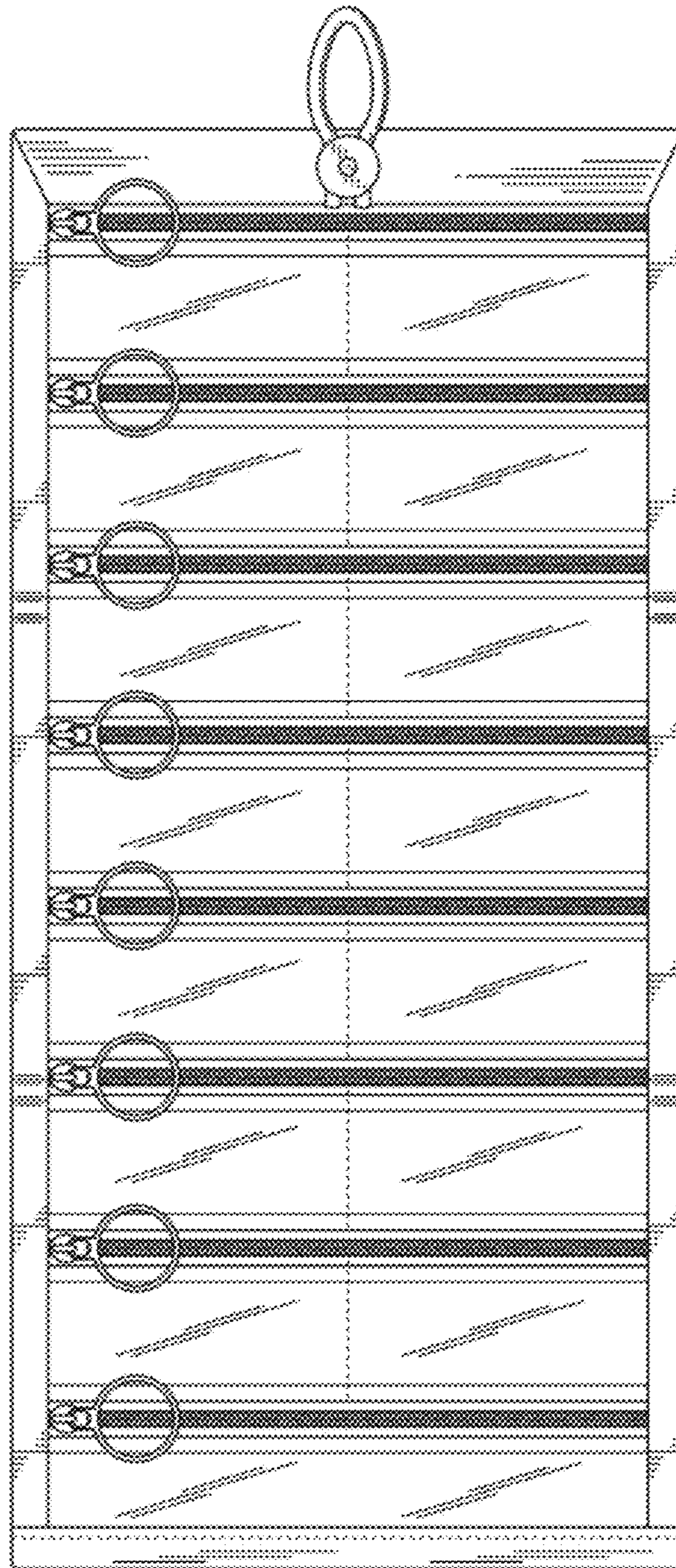

FIG. 2

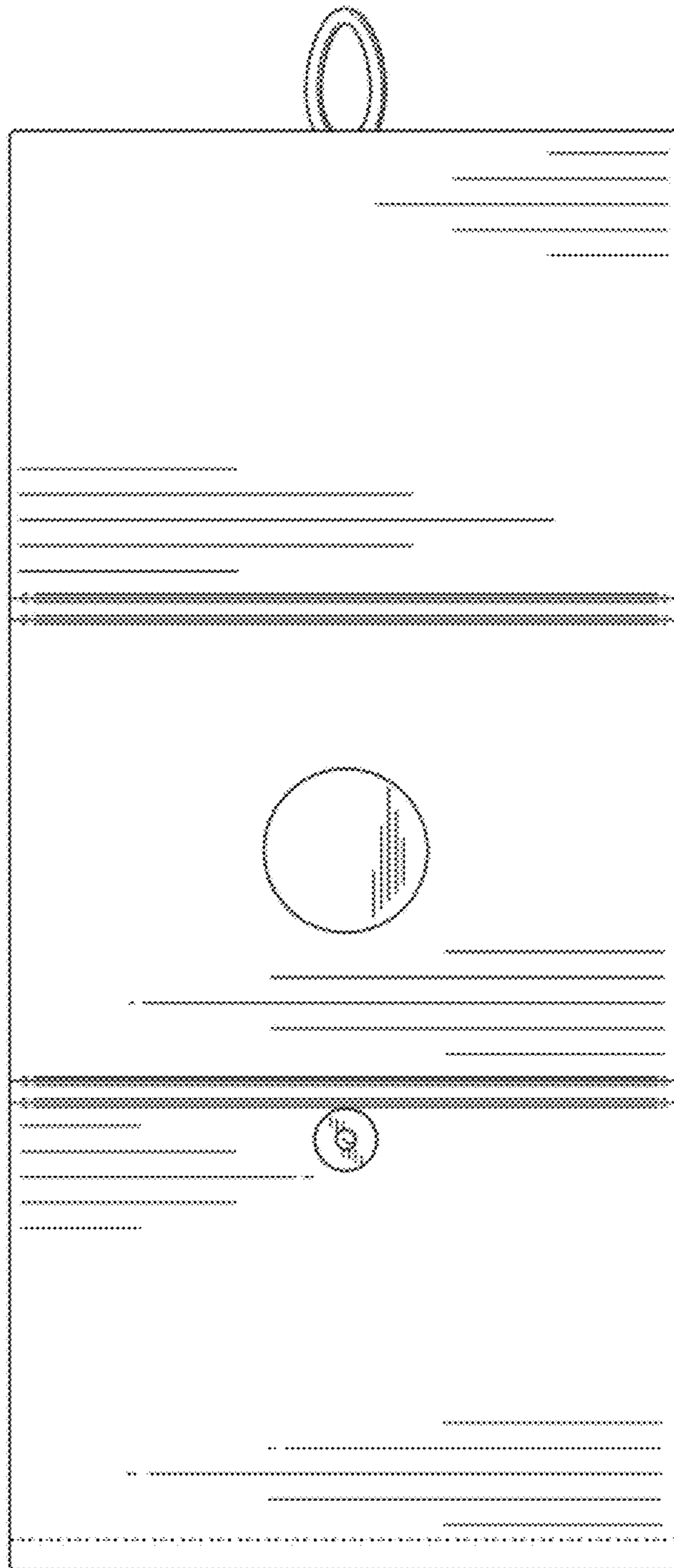

FIG. 3

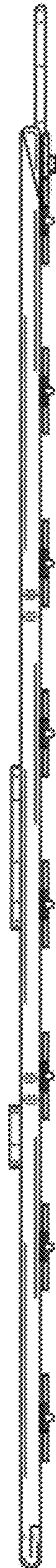

FIG. 4



FIG. 5



FIG. 6



FIG. 7

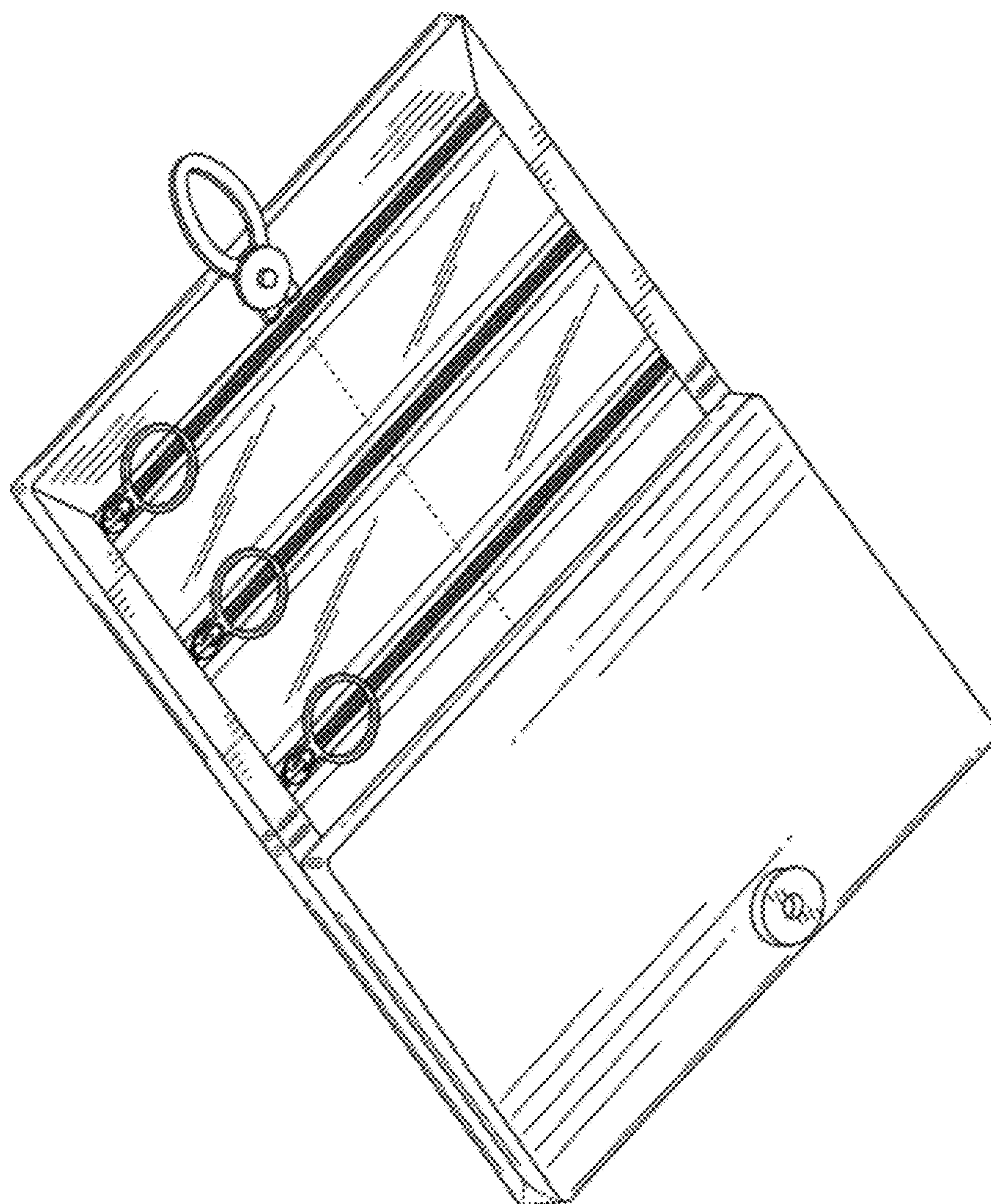

FIG. 8

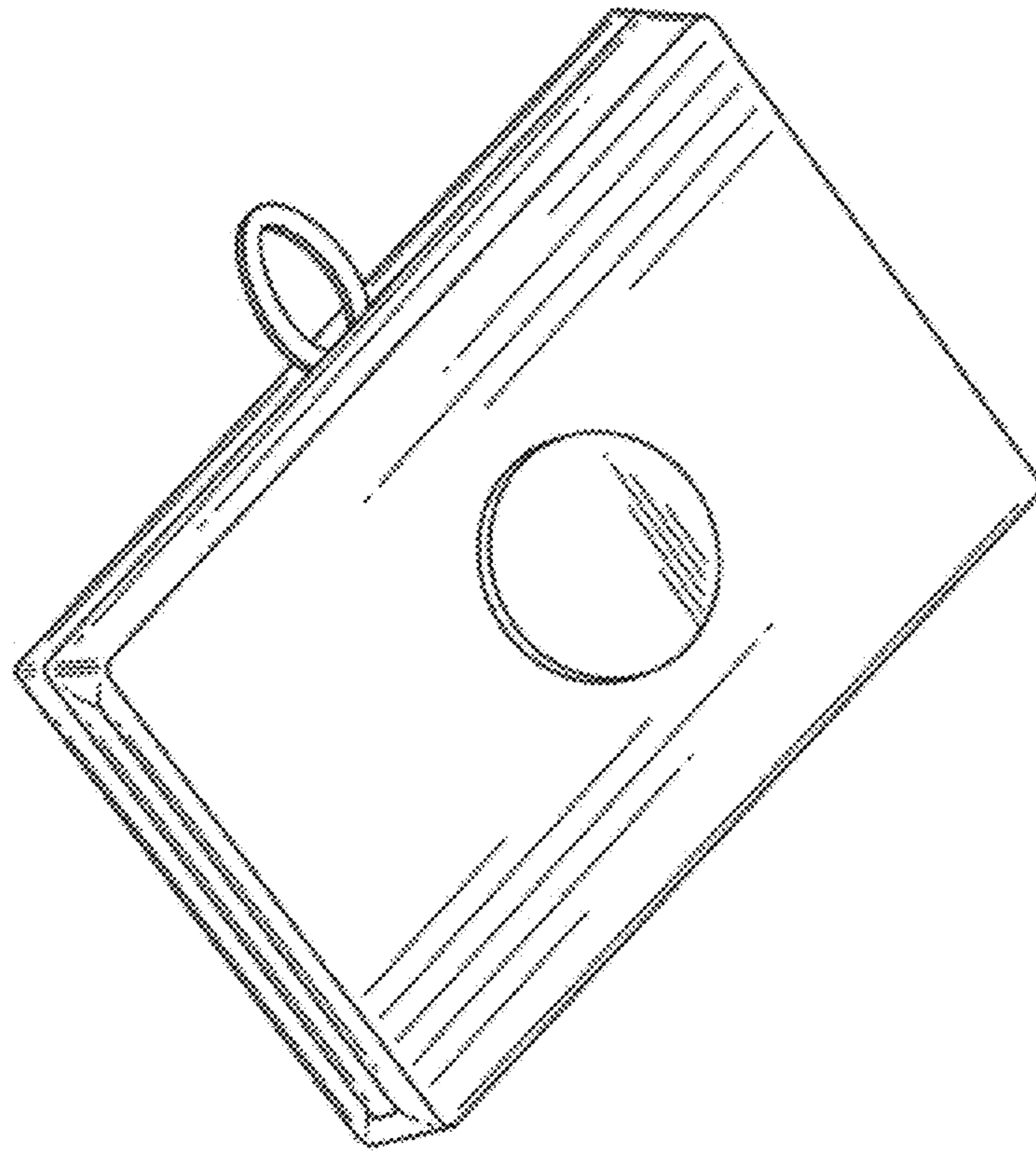

FIG. 9