

US00D673706S

(12) **United States Design Patent**
Inskeep

(10) **Patent No.:** **US D673,706 S**

(45) **Date of Patent:** **** Jan. 1, 2013**

(54) **SPOTLIGHT**

(76) Inventor: **Mathew Inskeep**, Boca Raton, FL (US)

(**) Term: **14 Years**

(21) Appl. No.: **29/411,589**

(22) Filed: **Jan. 24, 2012**

(51) **LOC (9) Cl.** **26-02**

(52) **U.S. Cl.** **D26/45**

(58) **Field of Classification Search** D26/37,
D26/38, 44, 45, 48, 49, 50; 362/157, 158,
362/184, 194-208

See application file for complete search history.

(56) **References Cited**

U.S. PATENT DOCUMENTS

D466,637 S *	12/2002	Gisser	D26/45
D500,155 S *	12/2004	Lee	D26/45
D532,136 S *	11/2006	Krieger et al.	D26/45
D599,926 S *	9/2009	Schoch	D26/45
D603,540 S *	11/2009	Shum et al.	D26/45

D658,325 S *	4/2012	Inskeep	D26/45
D658,796 S *	5/2012	Inskeep	D26/45
D662,240 S *	6/2012	Inskeep	D26/45

* cited by examiner

Primary Examiner — Ian Simmons

Assistant Examiner — Carissa C Fitts

(57) **CLAIM**

I claim the ornamental design for a spotlight, as shown and described.

DESCRIPTION

FIG. 1 is a top perspective view of the spotlight showing my new design.

FIG. 2 is a bottom perspective view.

FIG. 3 is a top view.

FIG. 4 is a bottom view.

FIG. 5 is left side view thereof.

FIG. 6 is a right side view thereof.

FIG. 7 is a front view thereof; and,

FIG. 8 is a back view thereof.

1 Claim, 8 Drawing Sheets

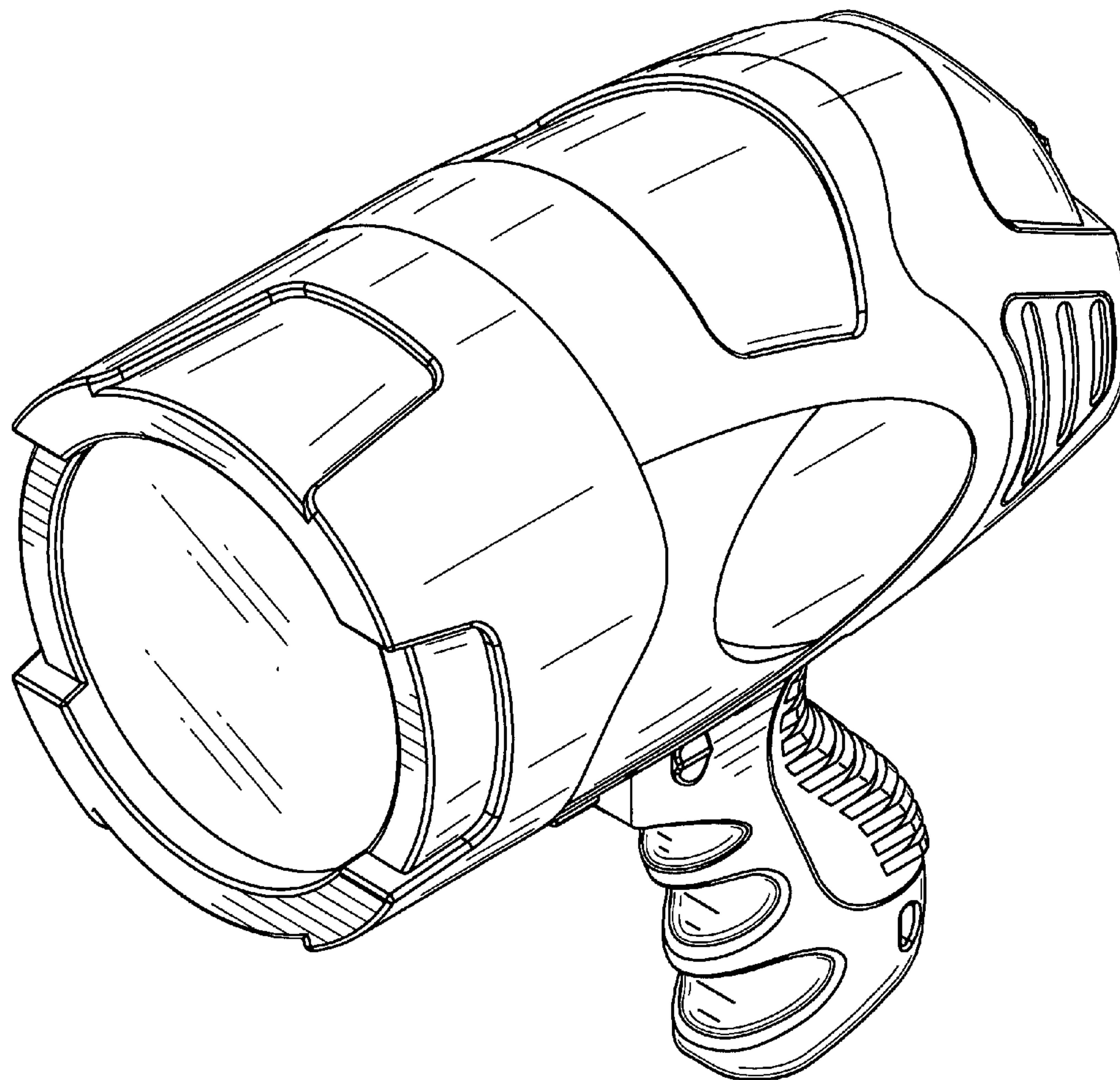

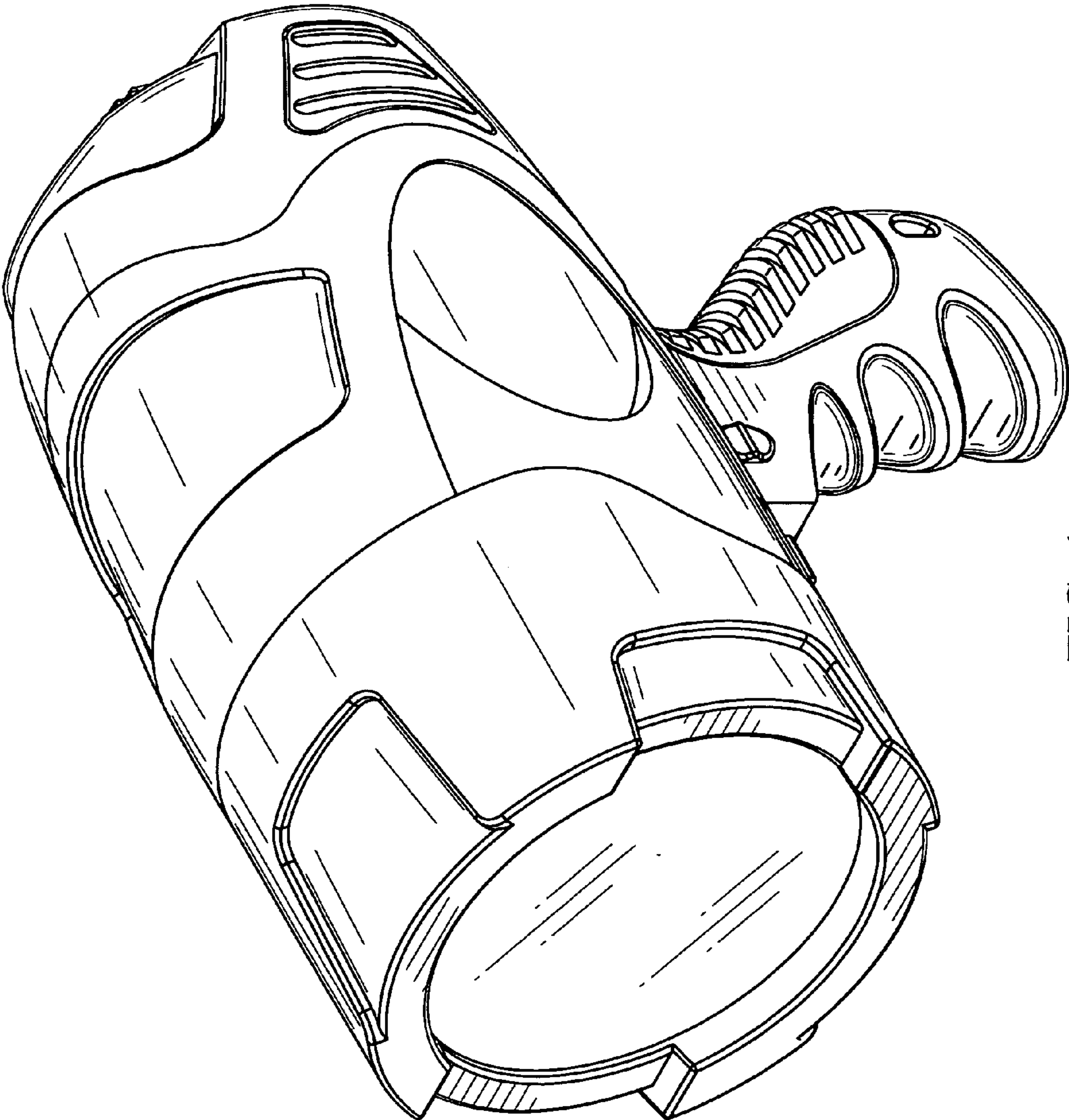

FIG. 1

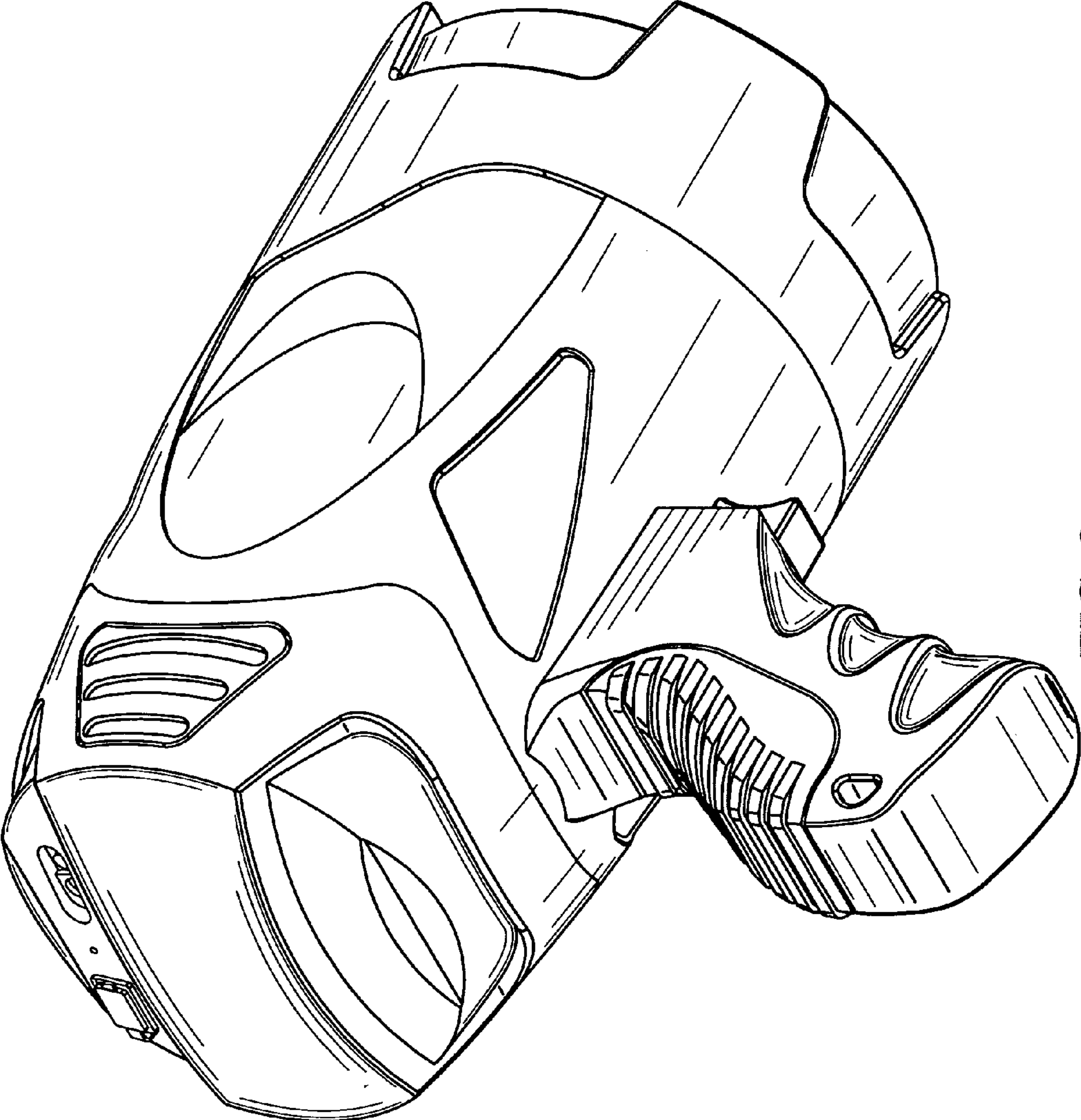

FIG. 2

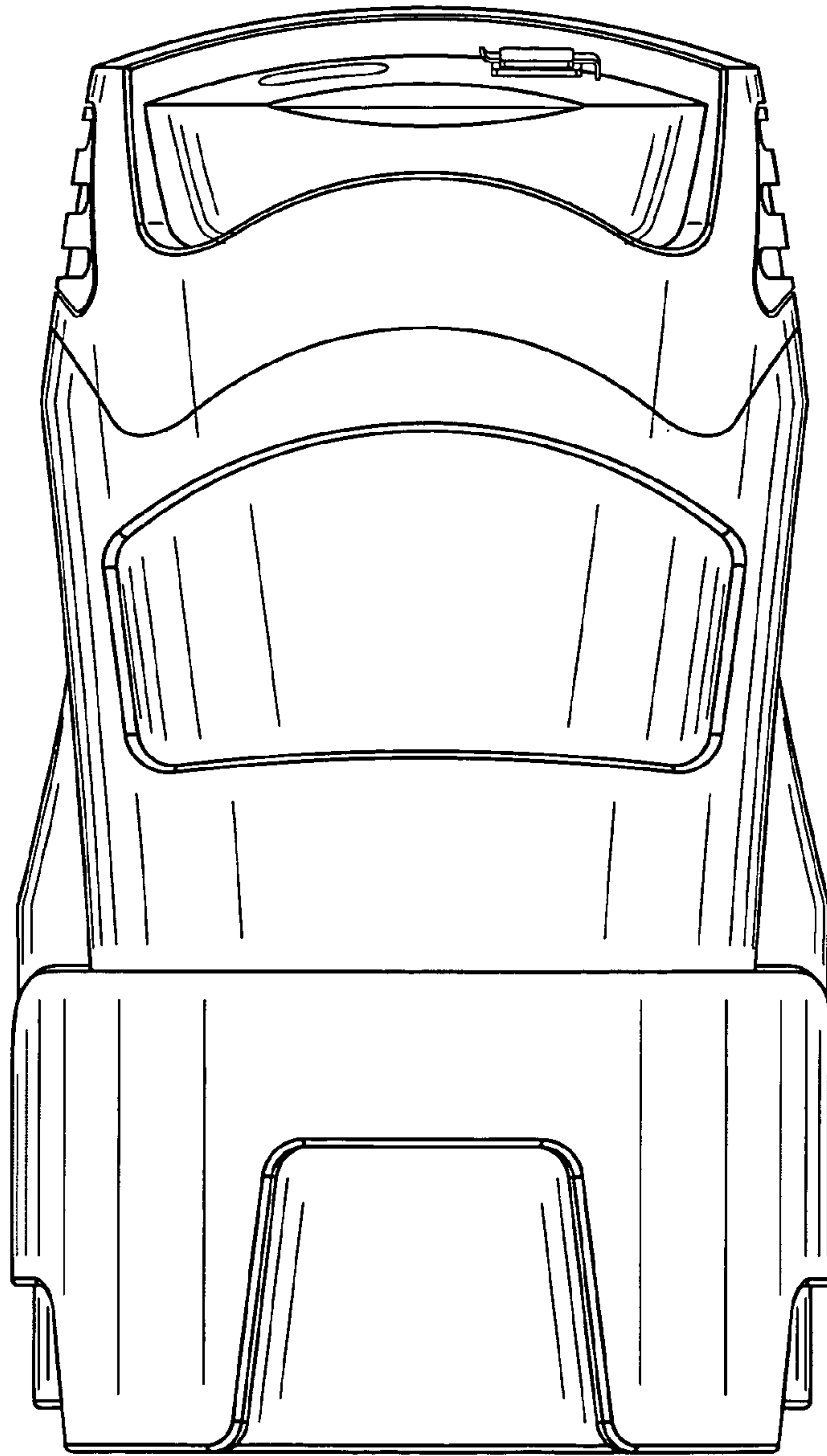

FIG. 3

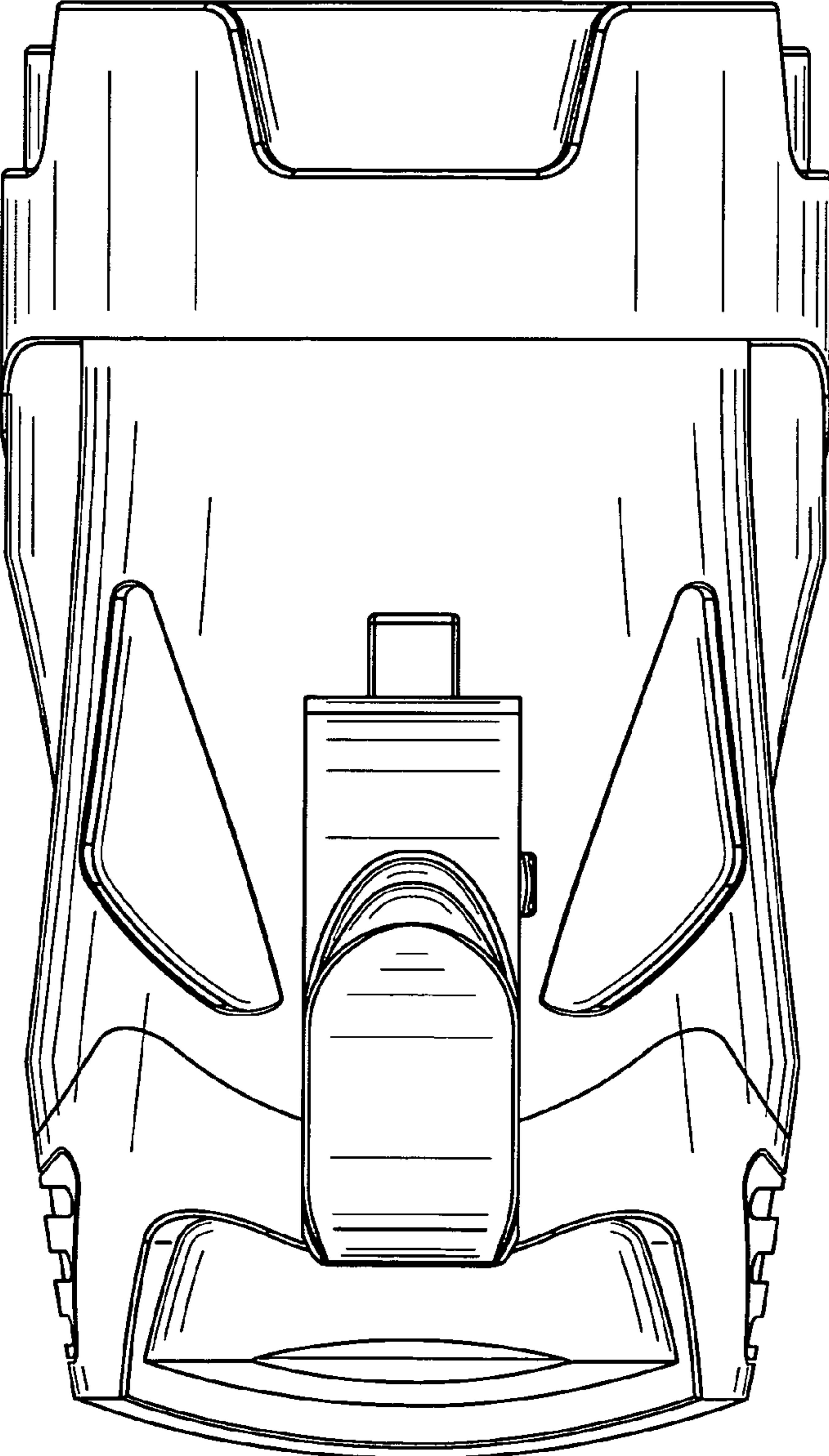

FIG. 4

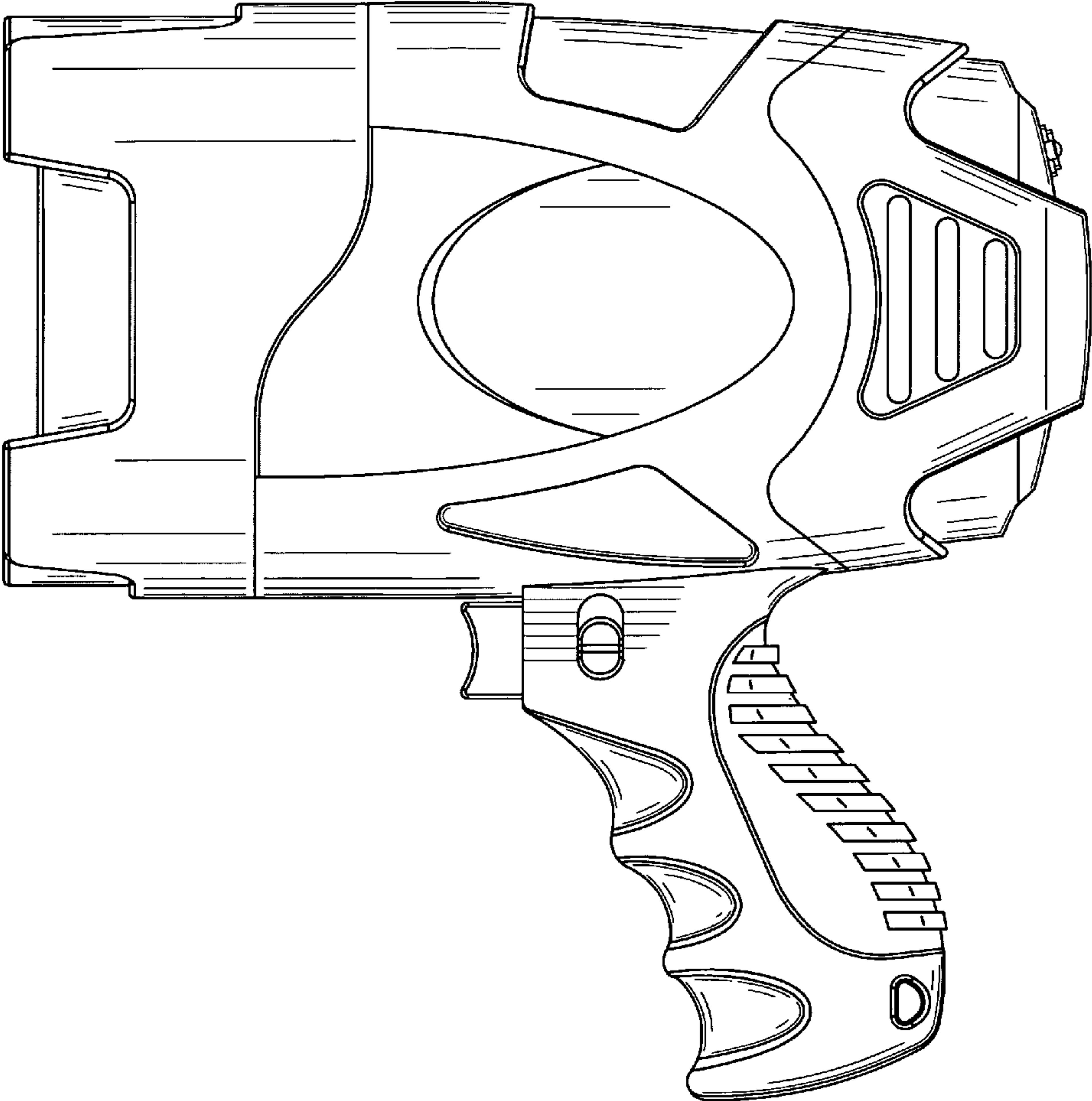

FIG. 5

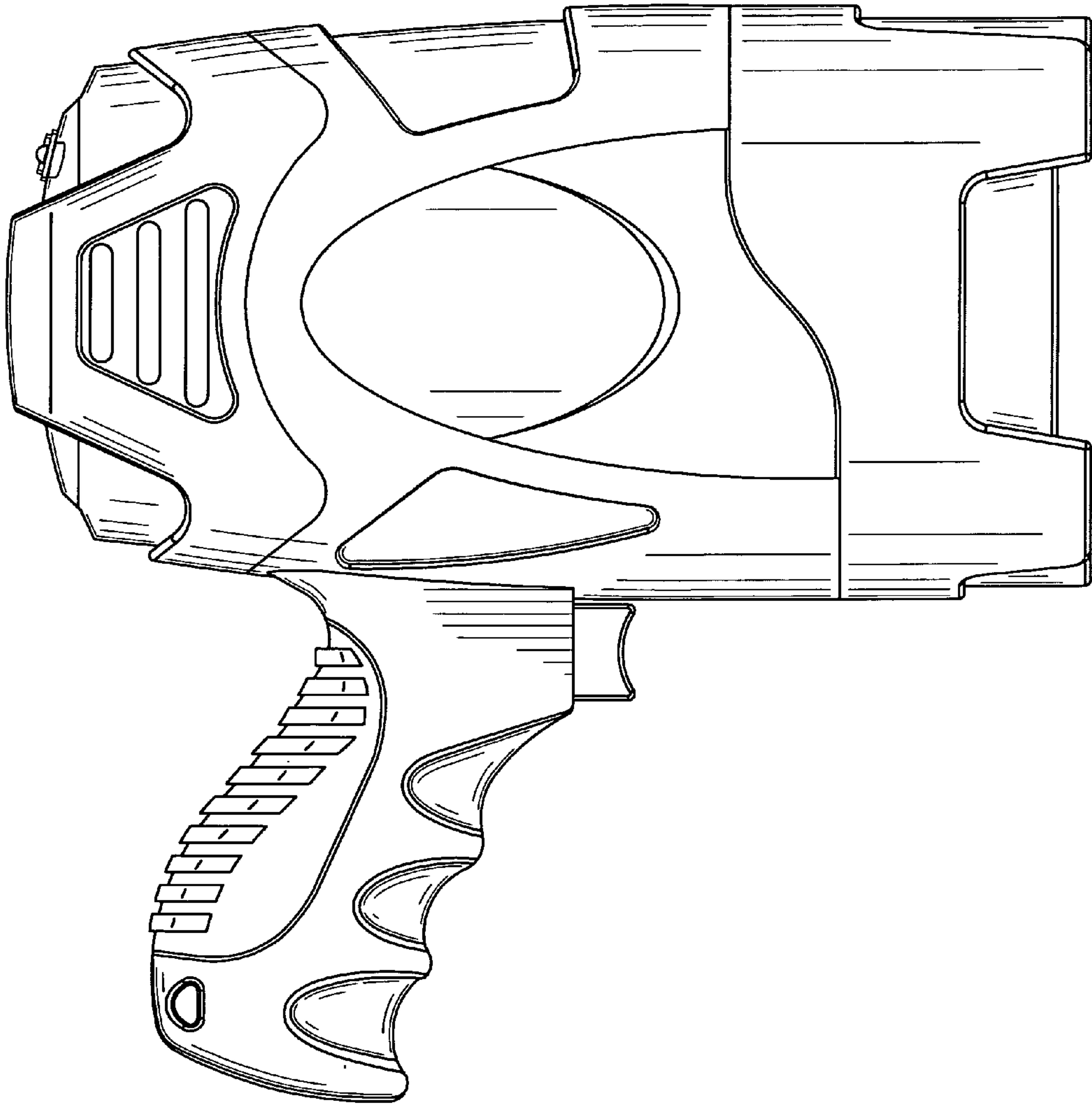

FIG. 6

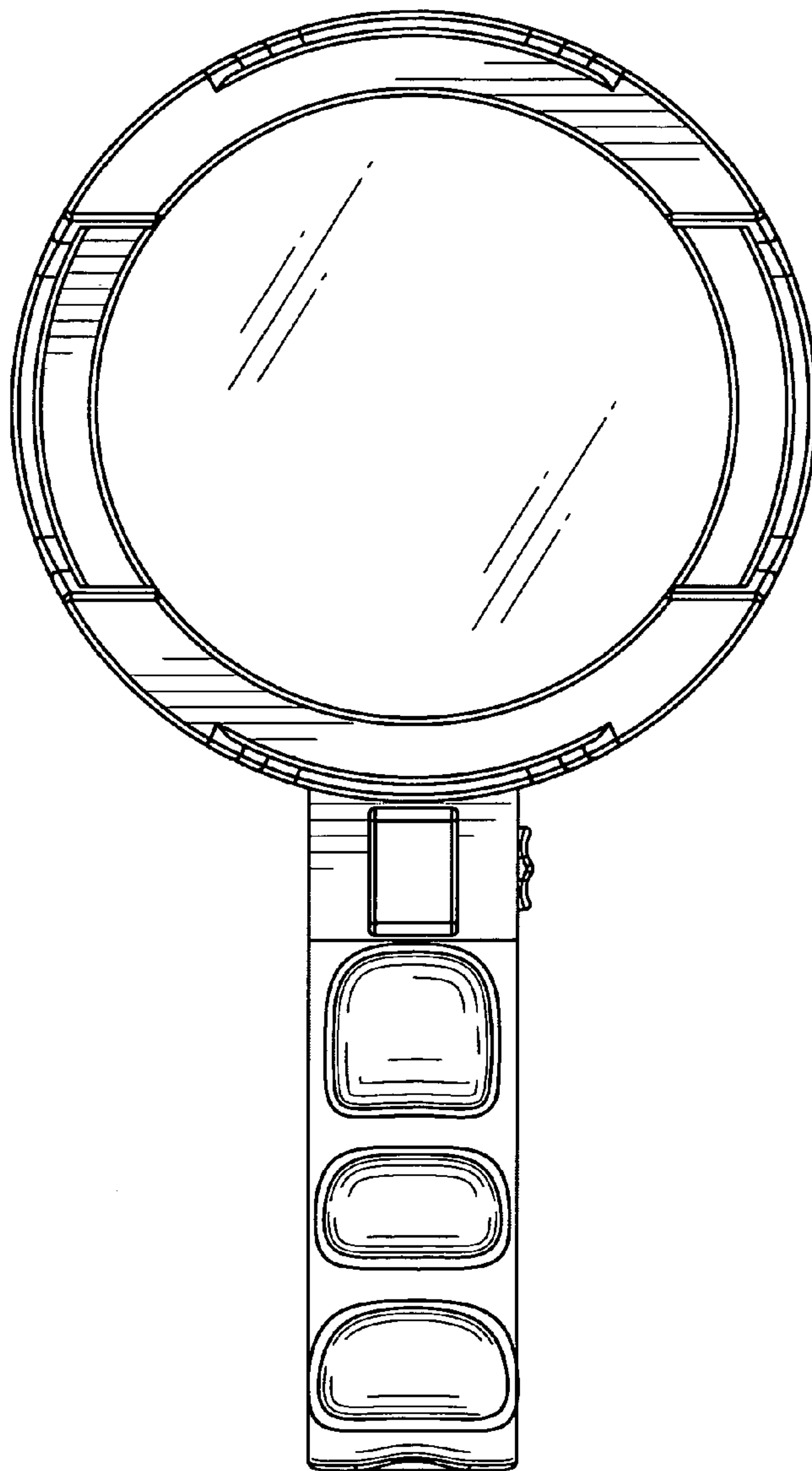

FIG. 7

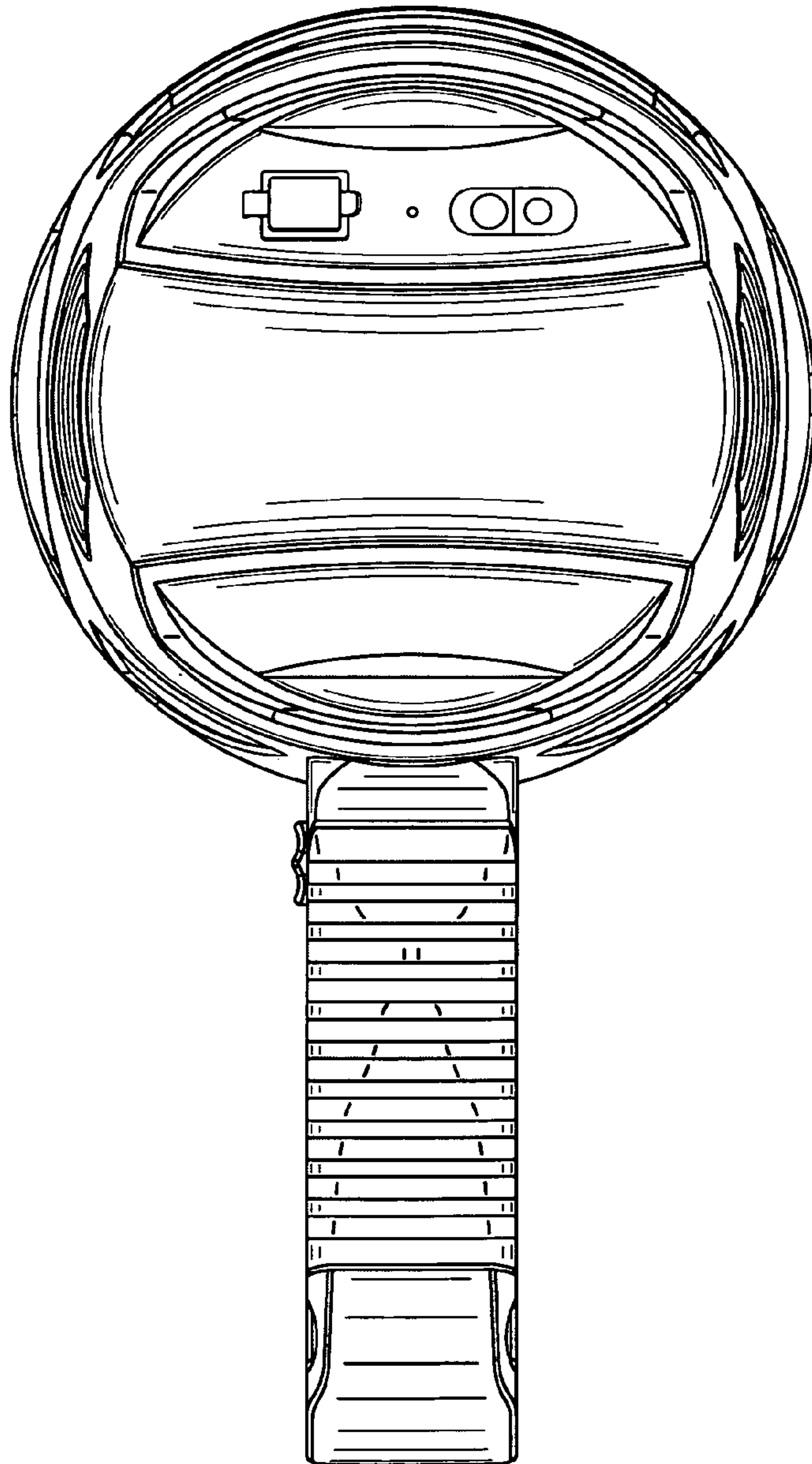

FIG. 8