



US00D673629S

(12) **United States Design Patent**  
**Breier et al.**

(10) **Patent No.:** **US D673,629 S**  
(45) **Date of Patent:** **\*\* Jan. 1, 2013**

(54) **IRON GOLF CLUB HEAD**

**DESCRIPTION**

(75) Inventors: **Joshua G. Breier**, Vista, CA (US);  
**Douglas E. Roberts**, Carlsbad, MA  
(US); **Ryan L. Roach**, Carlsbad, CA  
(US)  
(73) Assignee: **Cobra Golf Incorporated**, Carlsbad,  
CA (US)  
(\*\*) Term: **14 Years**  
(21) Appl. No.: **29/411,227**  
(22) Filed: **Jan. 18, 2012**  
(51) **LOC (9) Cl.** ..... **21-02**  
(52) **U.S. Cl.** ..... **D21/747**  
(58) **Field of Classification Search** ..... D21/747-751,  
D21/759; 473/324-331, 350  
See application file for complete search history.

FIG. 1 illustrates a front side perspective view of an iron golf club head employing an ornamental design in accordance with the present invention;  
FIG. 2 illustrates a back side perspective view of the iron golf club head of FIG. 1;  
FIG. 3 illustrates a top side view of the iron golf club head of FIG. 1;  
FIG. 4 illustrates a bottom side view of the iron golf club head of FIG. 1;  
FIG. 5 illustrates a front side view of the iron golf club head of FIG. 1;  
FIG. 6 illustrates a back side view of the iron golf club head of FIG. 1;  
FIG. 7 illustrates a right side view of the iron golf club head of FIG. 1;  
FIG. 8 illustrates a left side view of the iron golf club head of FIG. 1;  
FIG. 9 illustrates a front side perspective view of an iron golf club head employing an ornamental design in accordance with the present invention;  
FIG. 10 illustrates a back side perspective view of the iron golf club head of FIG. 9;  
FIG. 11 illustrates a top side view of the iron golf club head of FIG. 9;  
FIG. 12 illustrates a bottom side view of the iron golf club head of FIG. 9;  
FIG. 13 illustrates a front side view of the iron golf club head of FIG. 9;  
FIG. 14 illustrates a back side view of the iron golf club of FIG. 9;  
FIG. 15 illustrates a right side view of the iron golf club head of FIG. 9; and,  
FIG. 16 illustrates a left side view of the iron golf club head of FIG. 9.  
All features illustrated in phantom line are expressly disclaimed and form no part of the claimed design.

(56) **References Cited**

**U.S. PATENT DOCUMENTS**

D473,605 S *	4/2003	Petersen et al. ....	D21/747
D473,606 S *	4/2003	Mickelson et al. ....	D21/747
D516,649 S *	3/2006	Imamoto .....	D21/747
D517,626 S *	3/2006	Gilbert et al. ....	D21/747
D523,917 S *	6/2006	Wolfe et al. ....	D21/747
D549,797 S *	8/2007	Oldknow .....	D21/759
D550,796 S *	9/2007	Nagai et al. ....	D21/759
D647,984 S *	11/2011	Atwell et al. ....	D21/747

\* cited by examiner

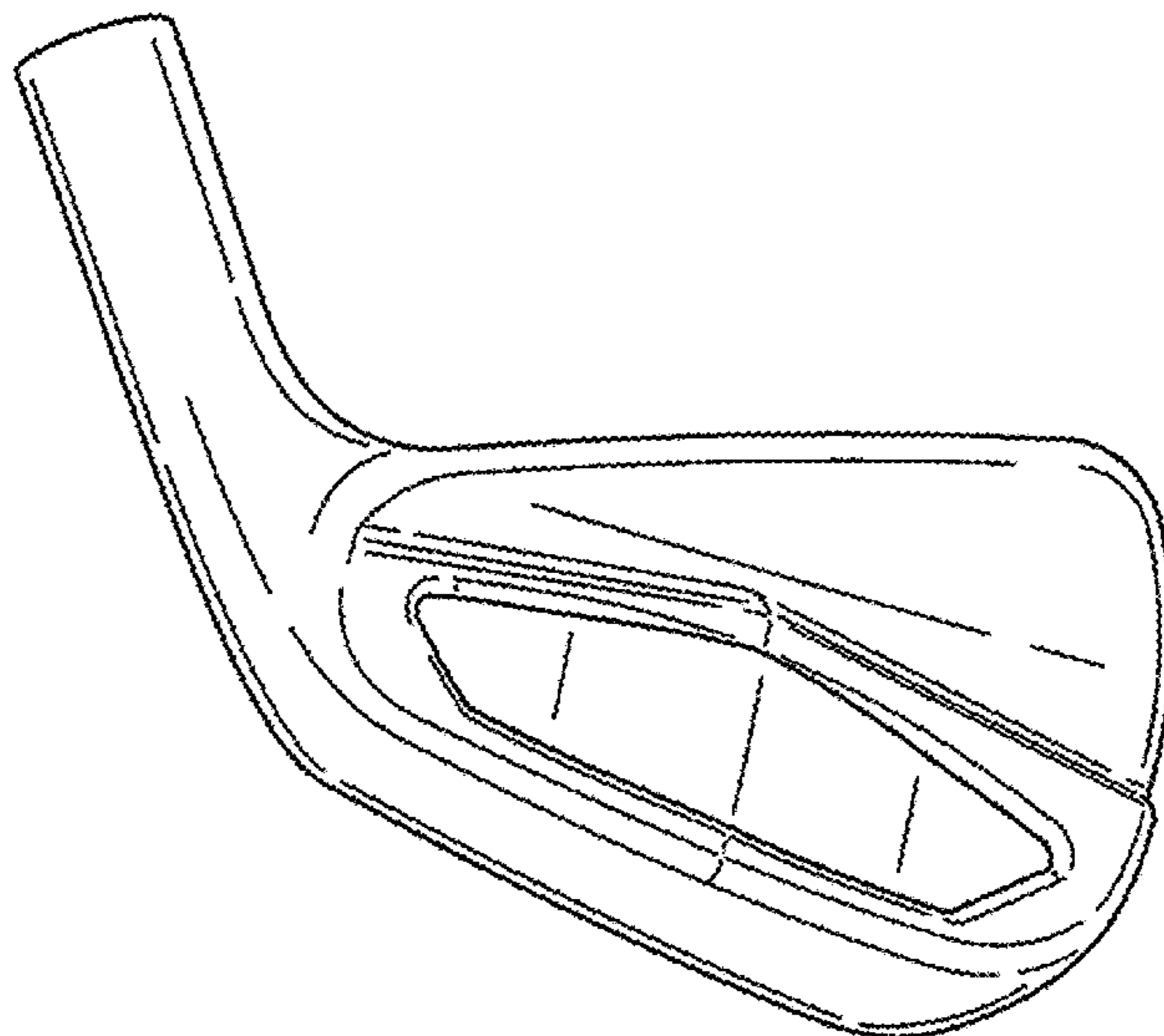
*Primary Examiner* — Mitchell Siegel

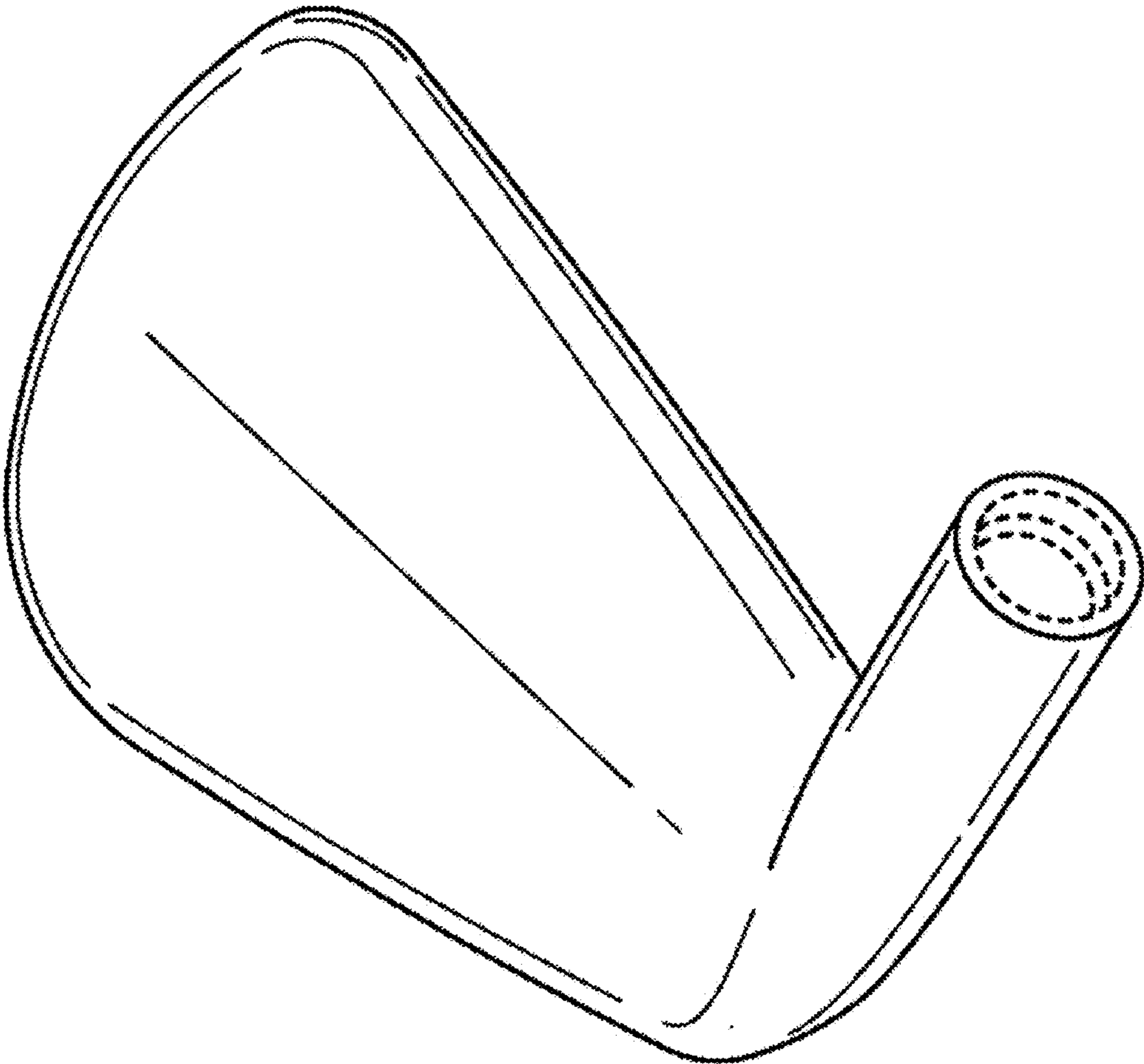
(74) *Attorney, Agent, or Firm* — Mark S. Leonardo; Brown Rudnick LLP

(57) **CLAIM**

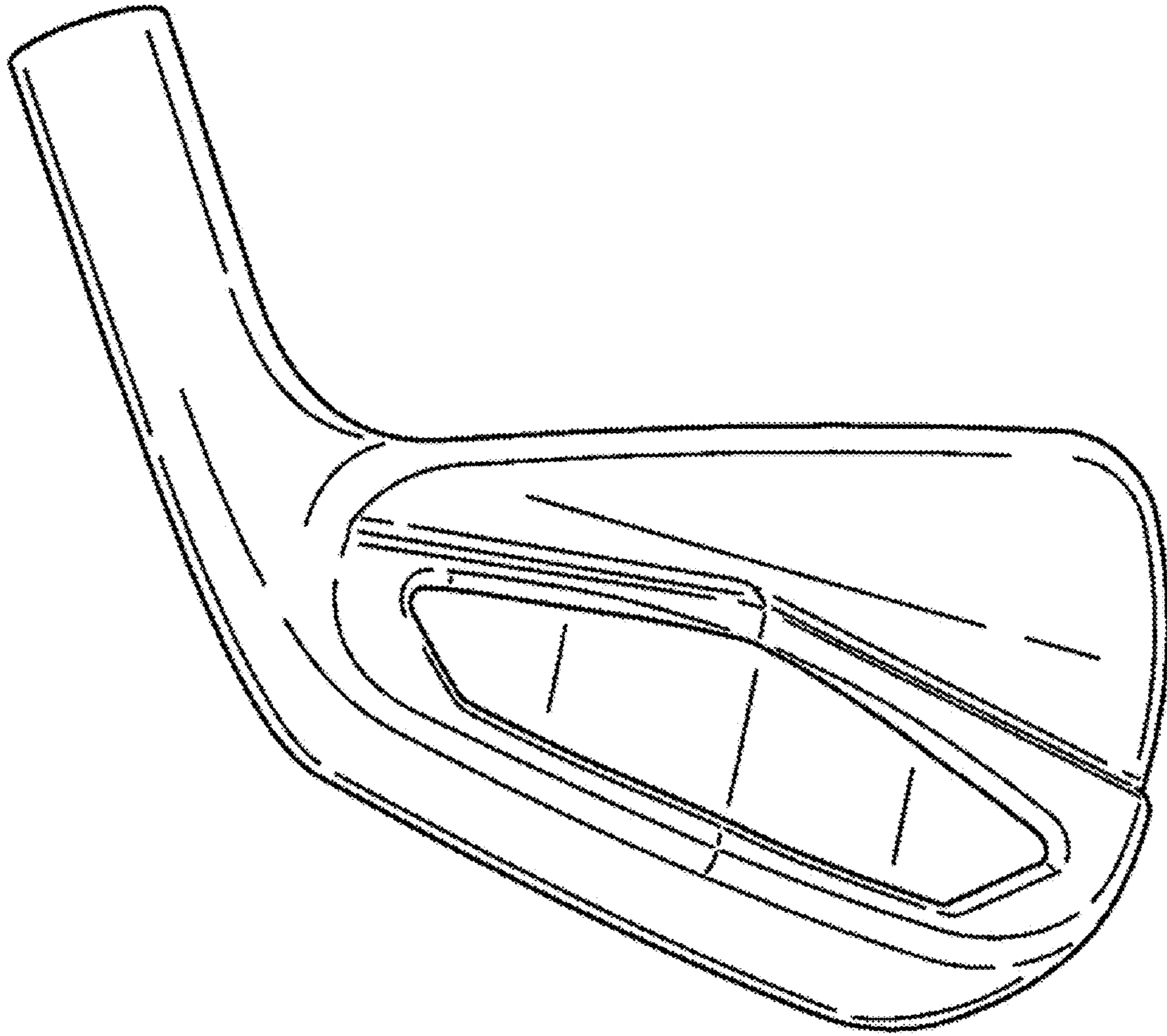
The ornamental design for an iron golf club head, as shown and described.

**1 Claim, 10 Drawing Sheets**

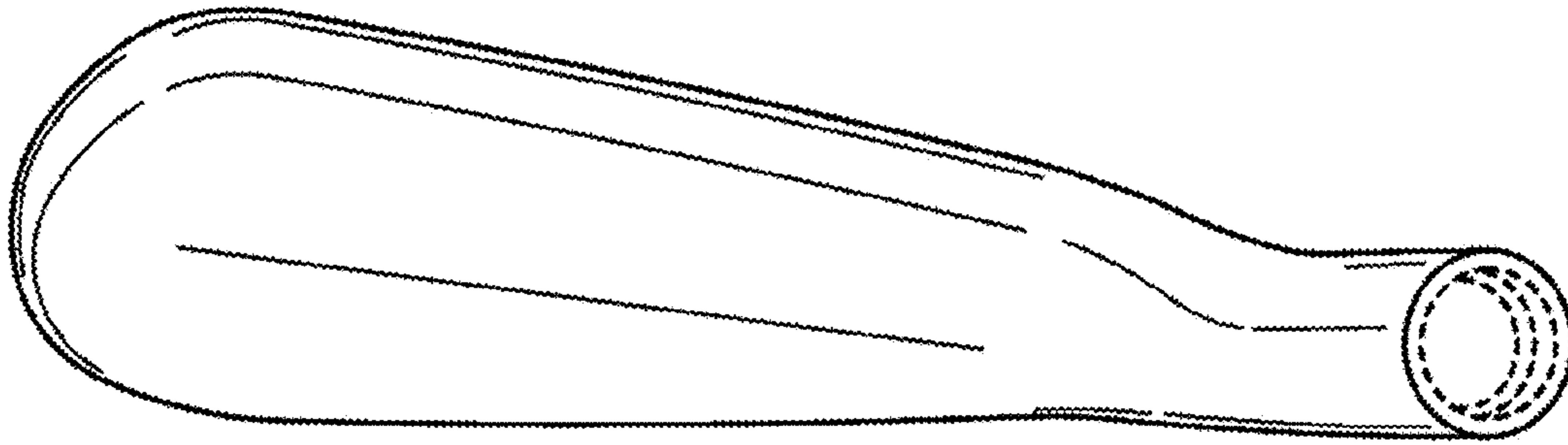




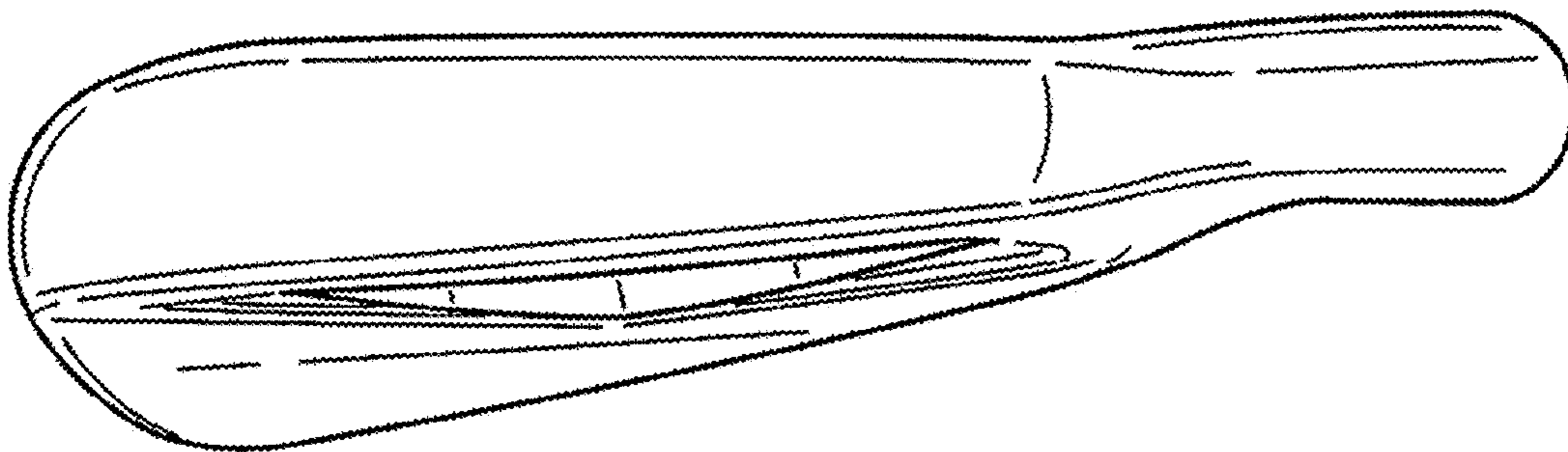
**FIG. 1**



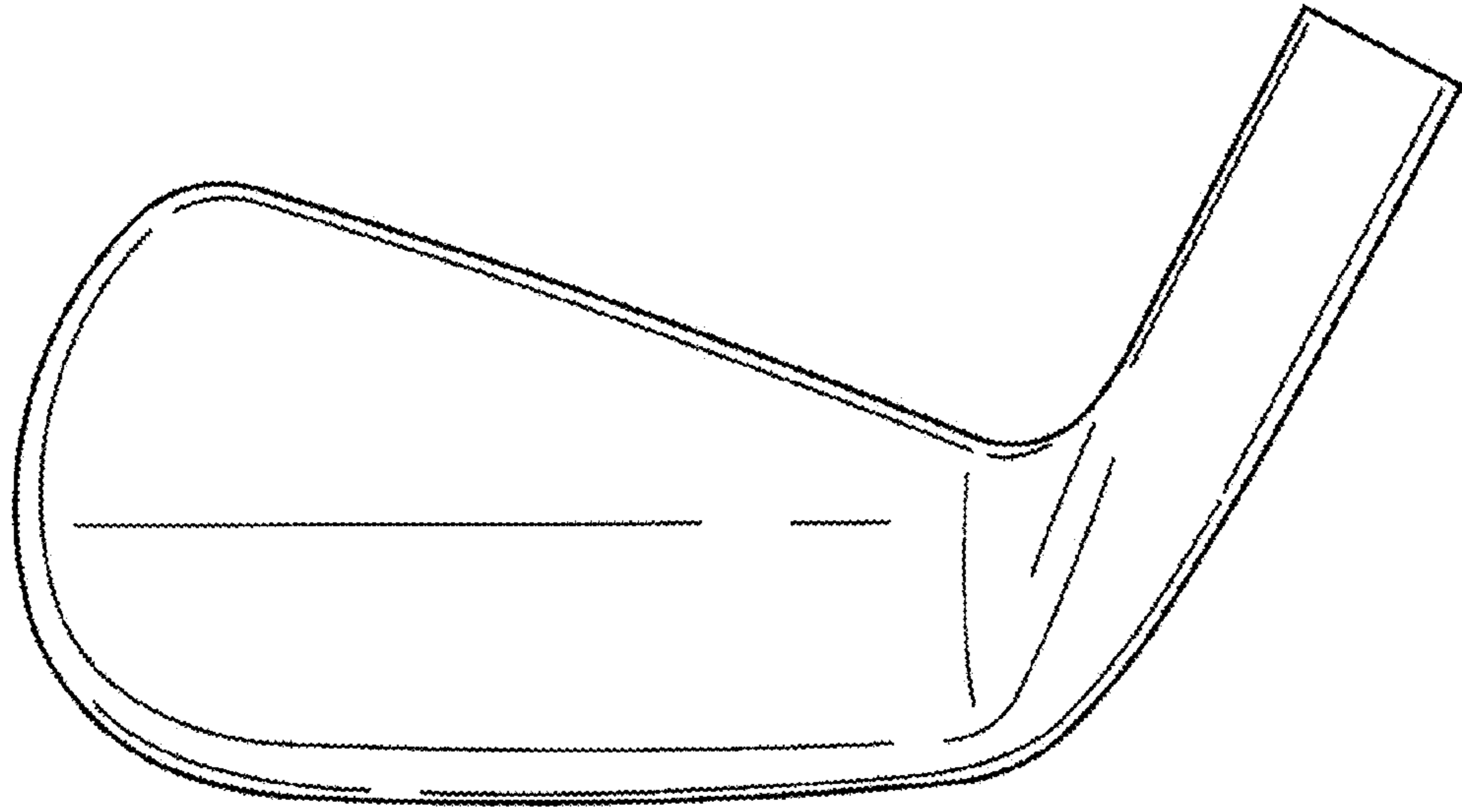
***FIG. 2***



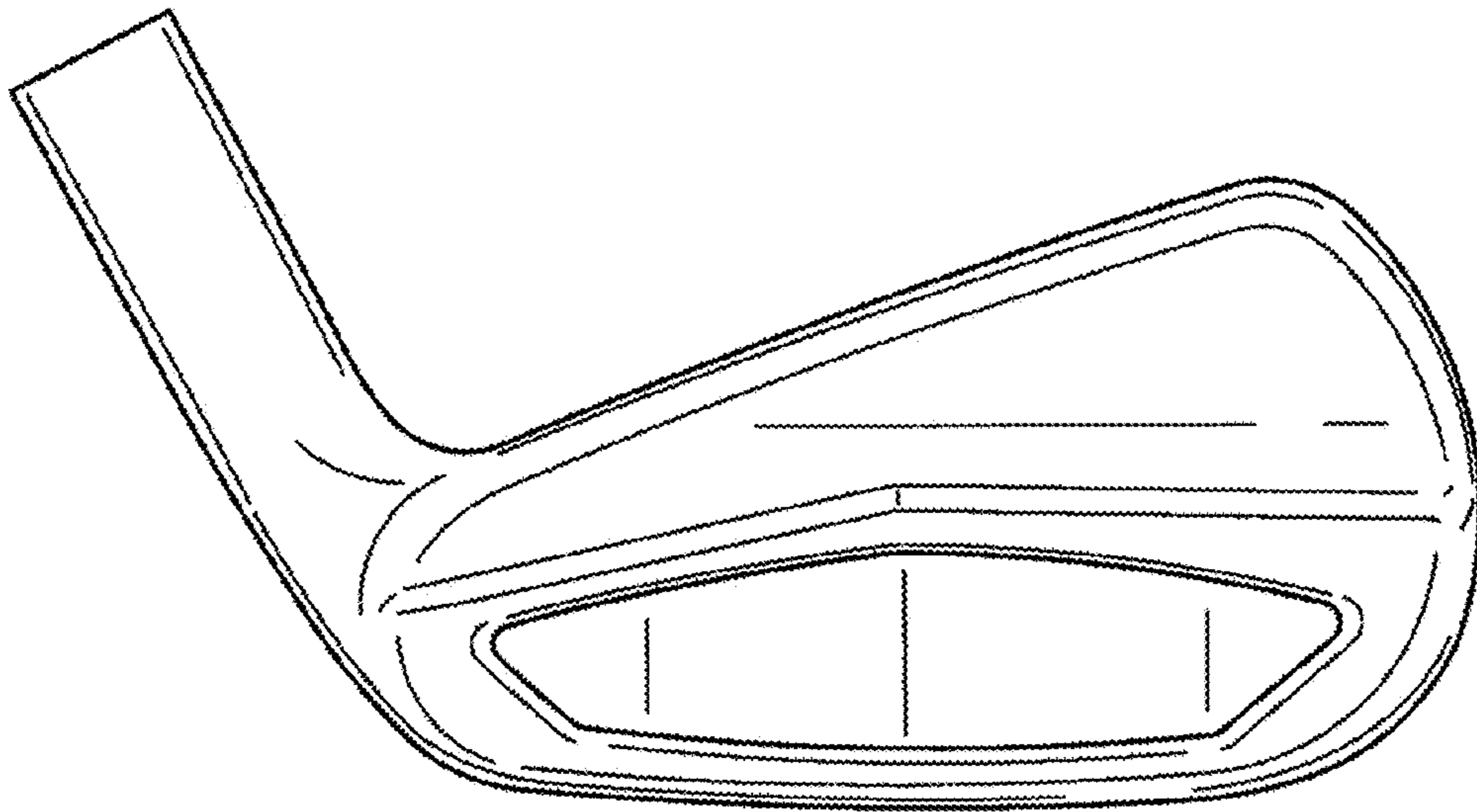
**FIG. 3**



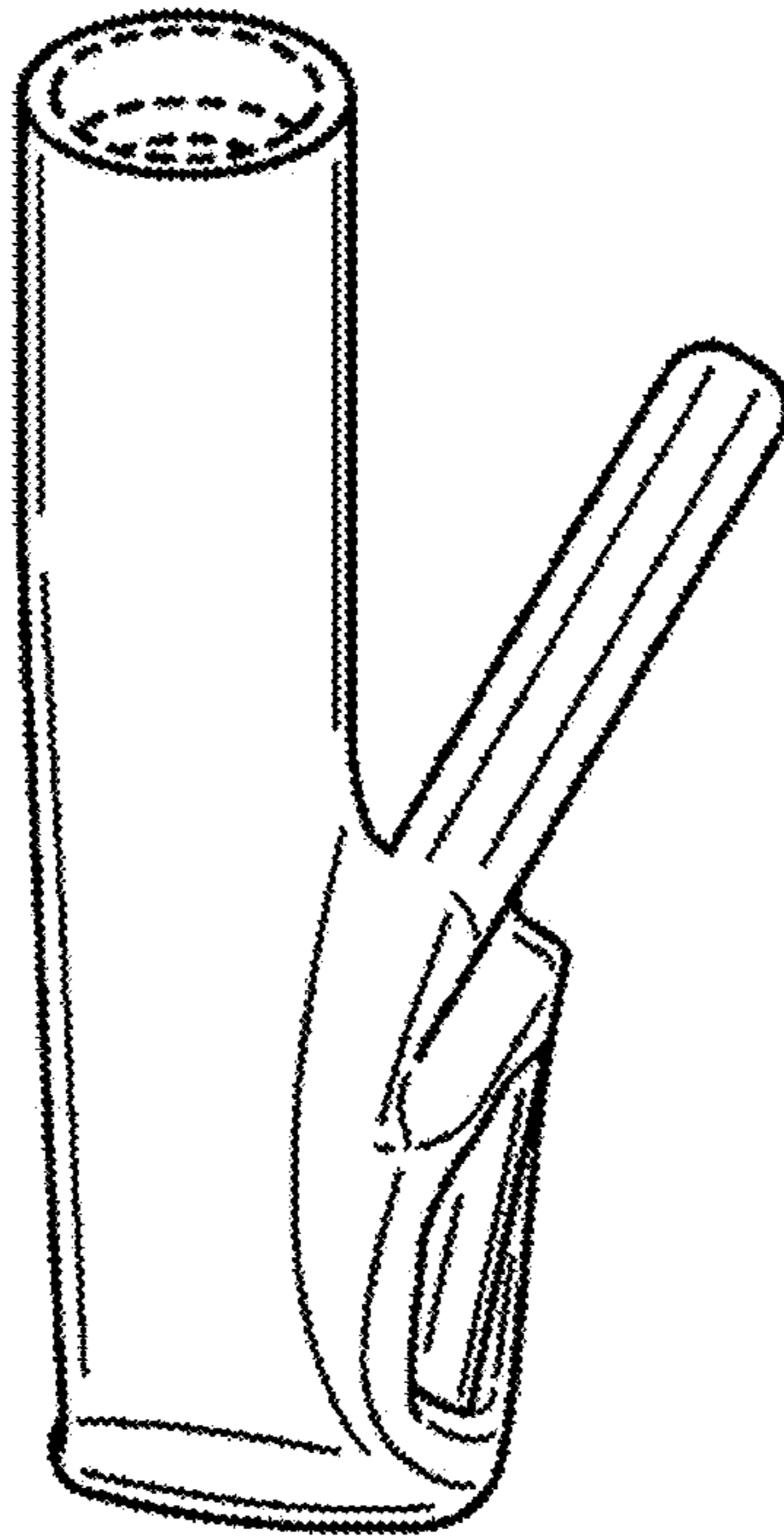
**FIG. 4**



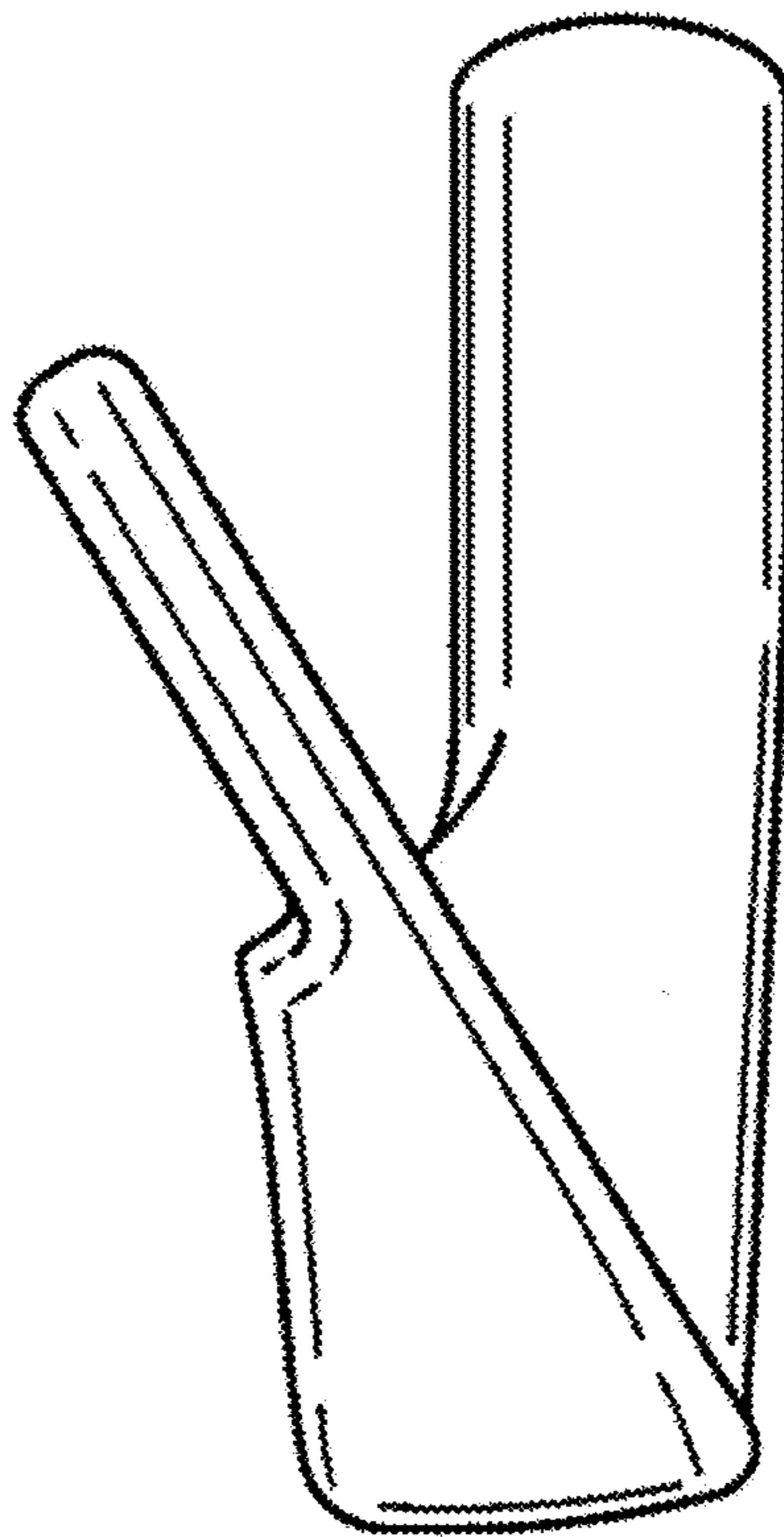
**FIG. 5**



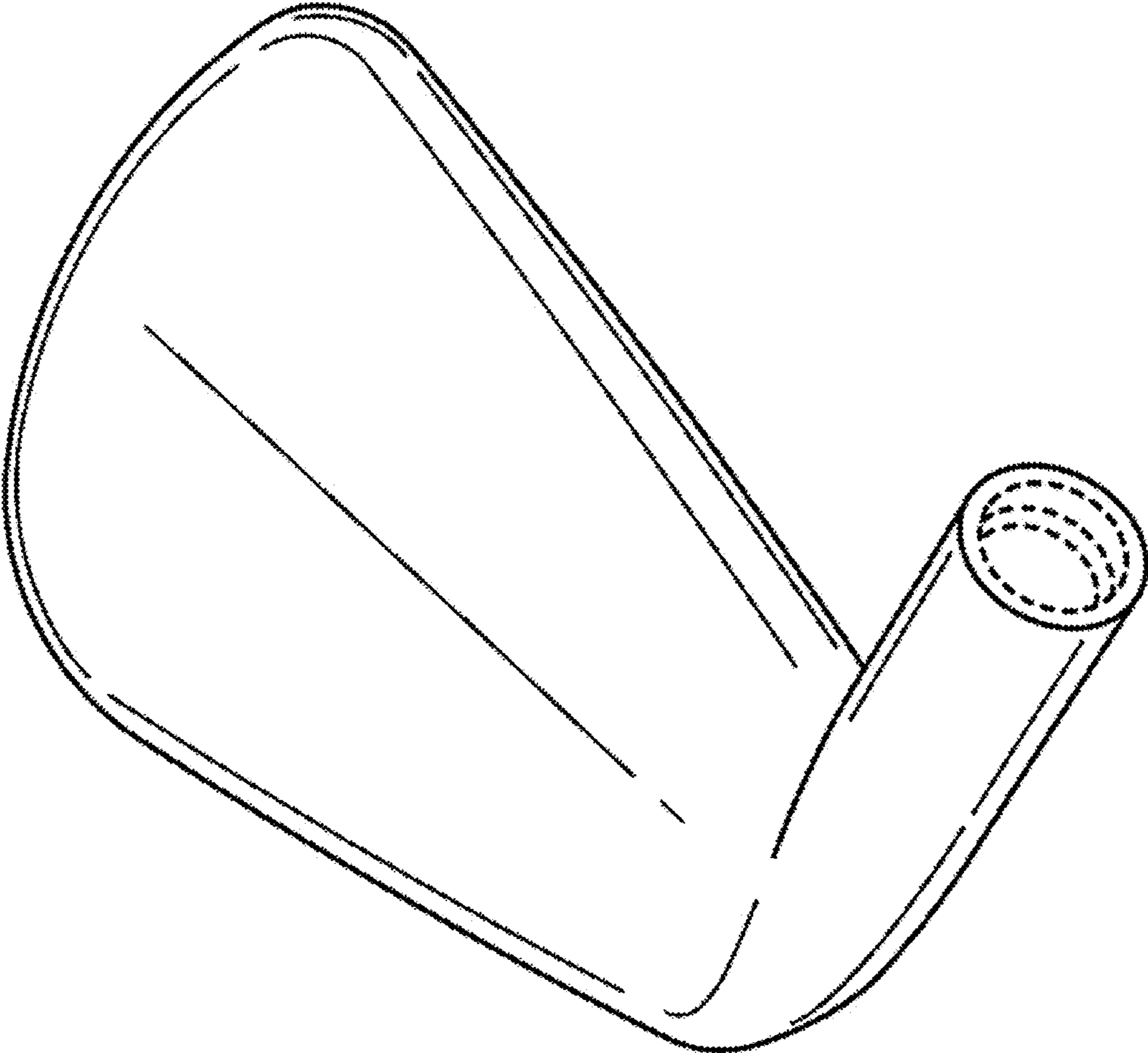
**FIG. 6**



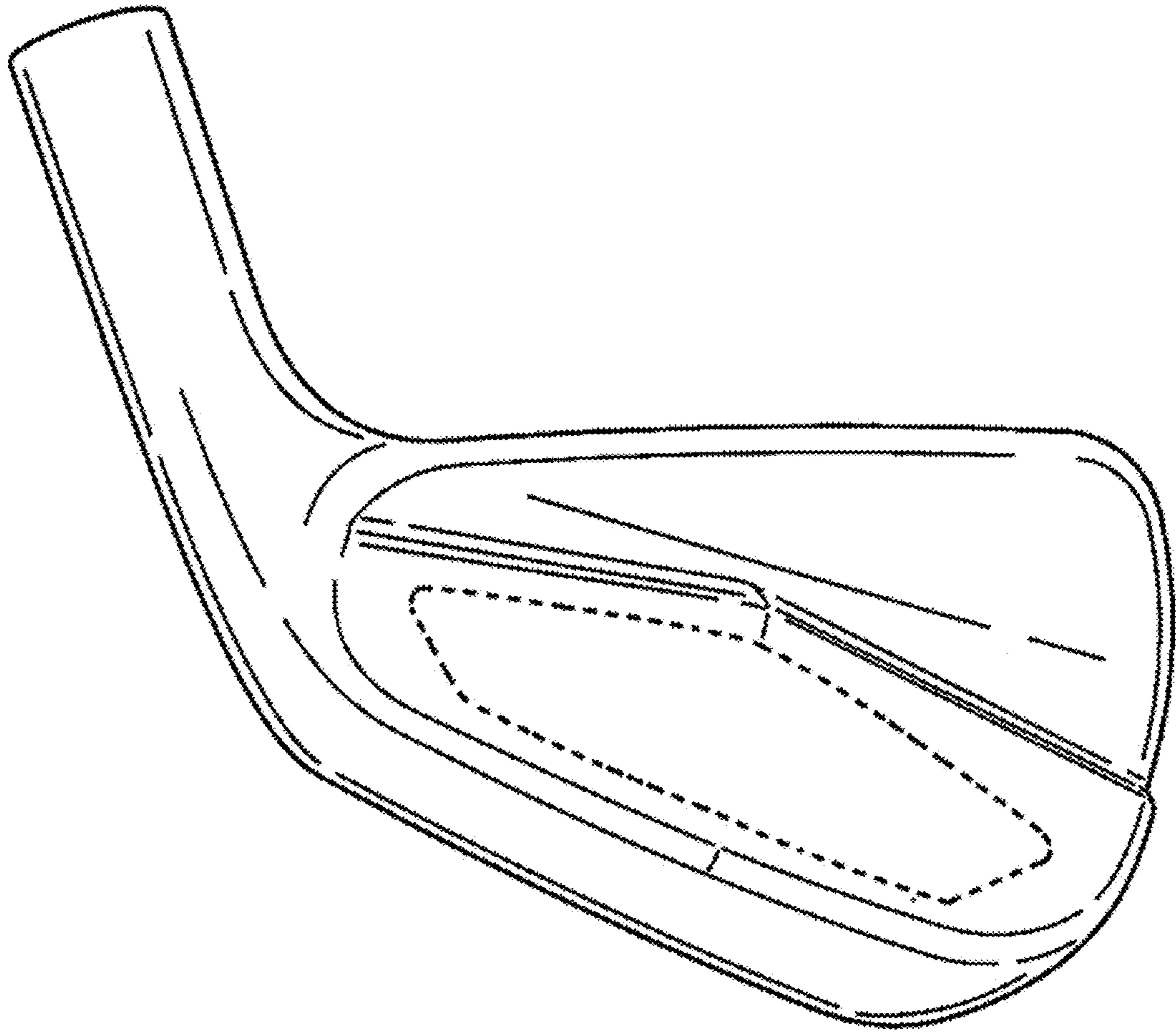
**FIG. 7**



**FIG. 8**

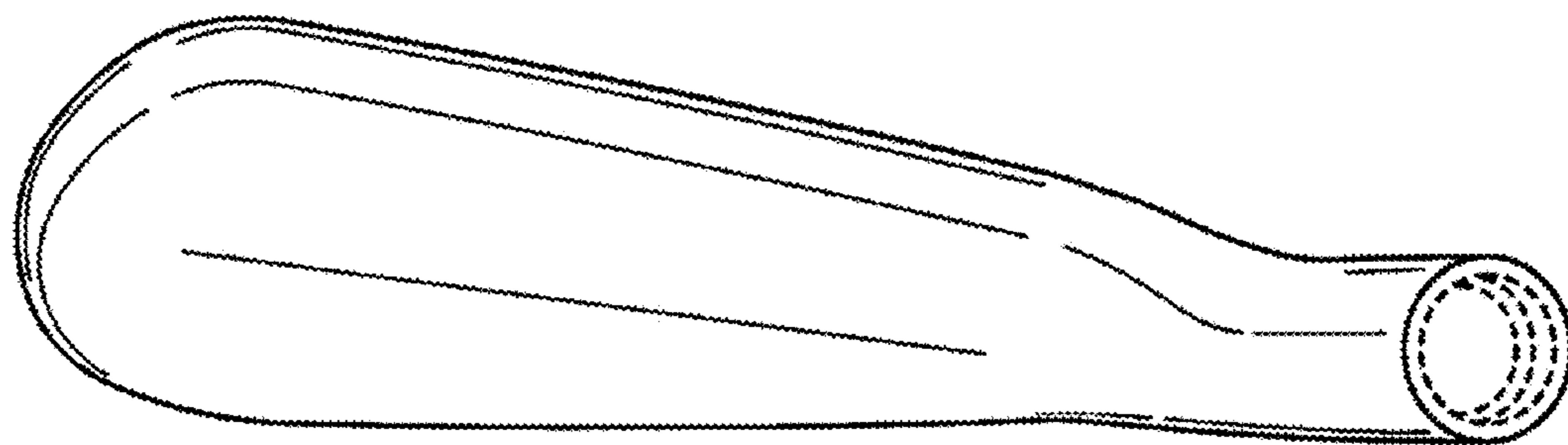


**FIG. 9**

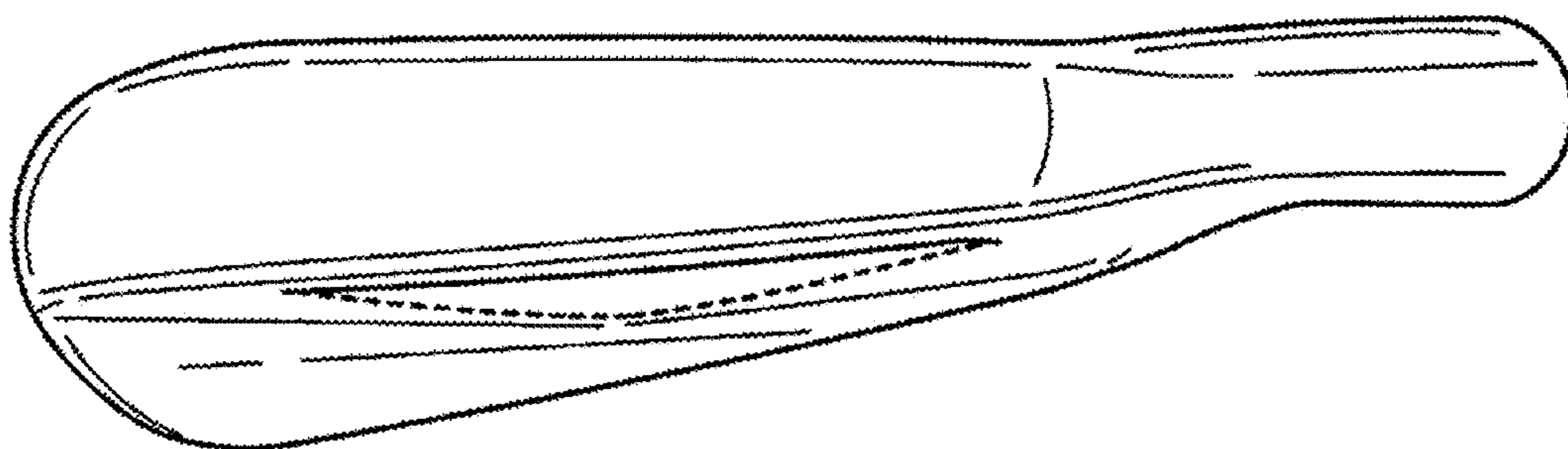


***FIG. 10***

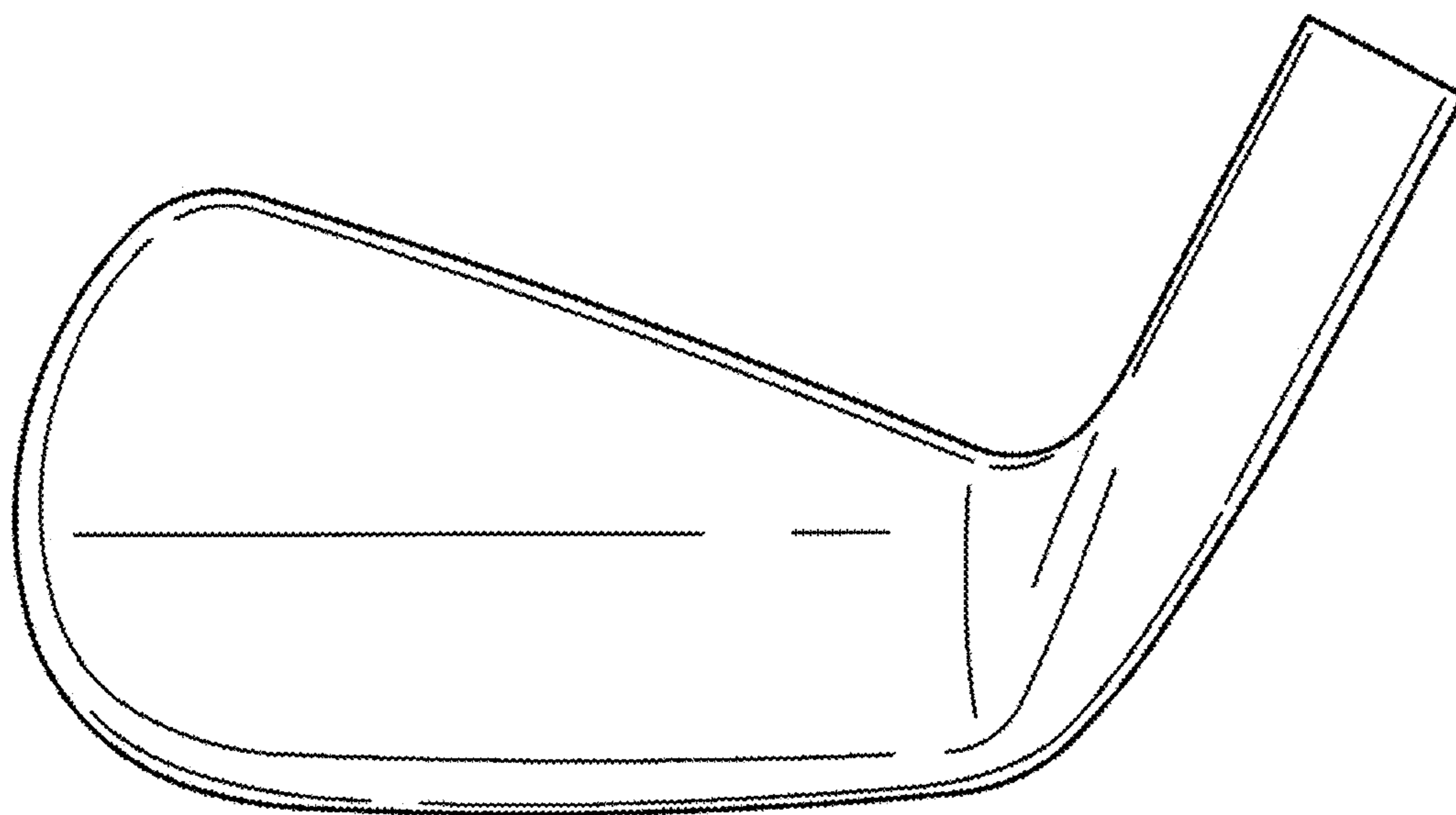




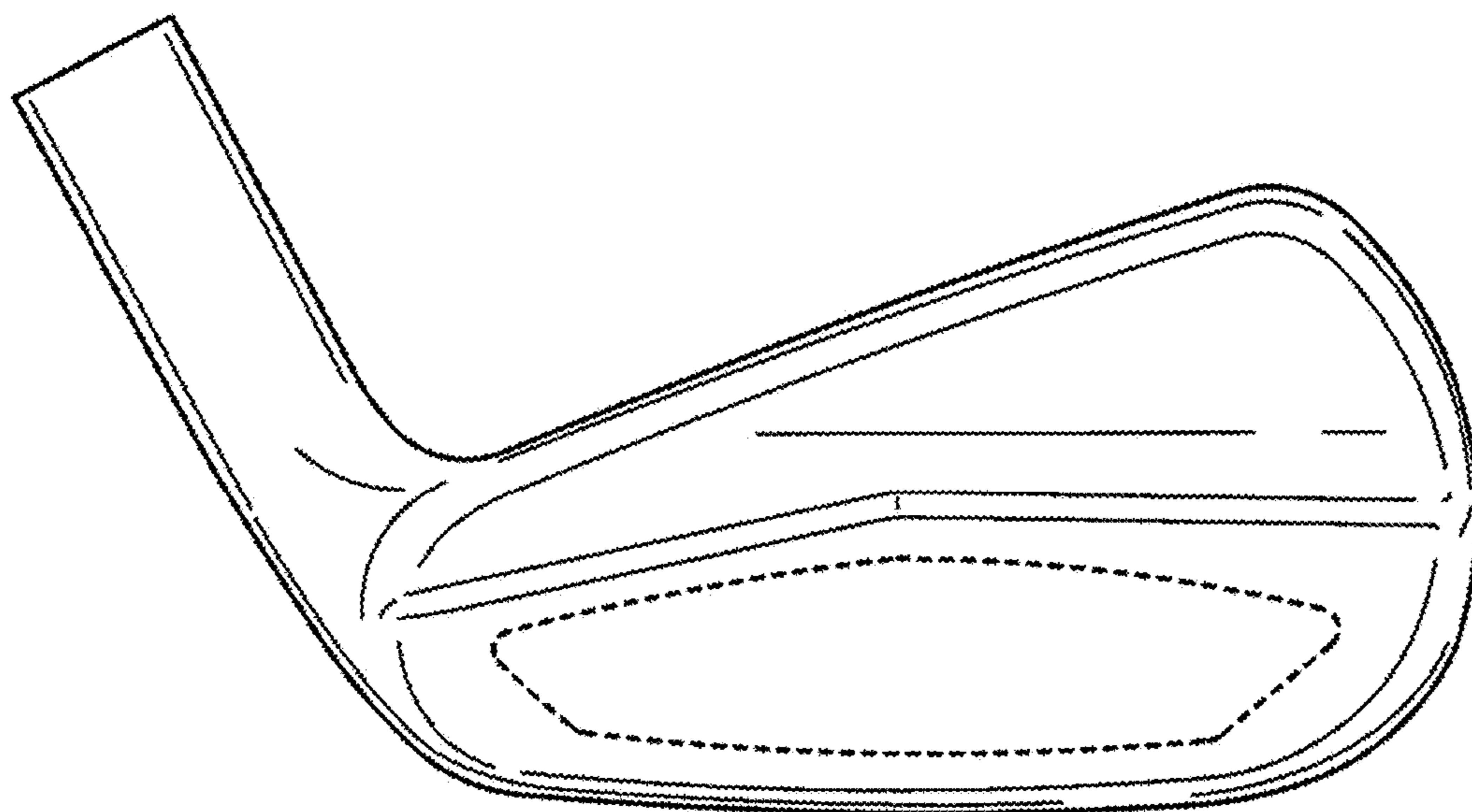
*FIG. 11*



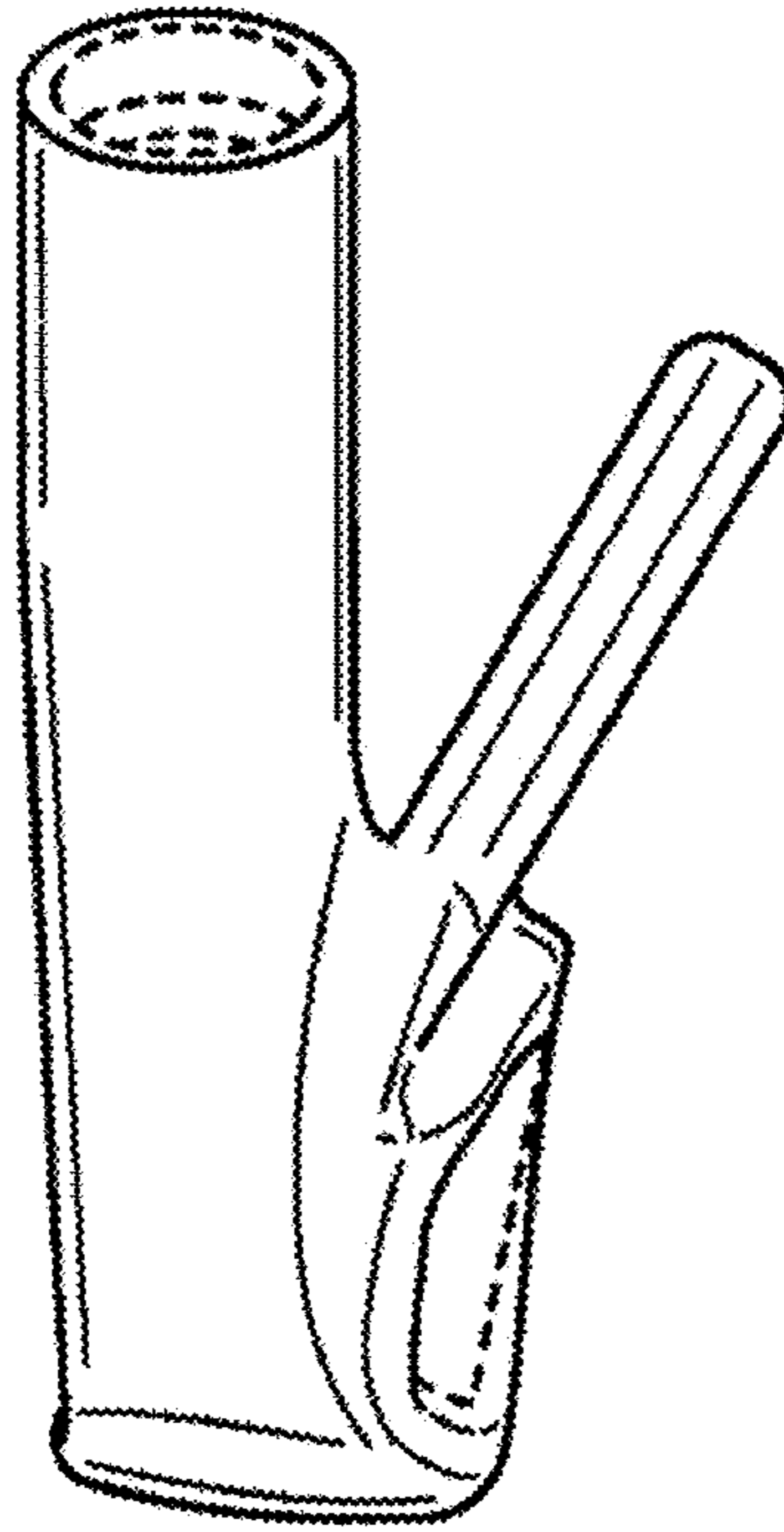
*FIG. 12*



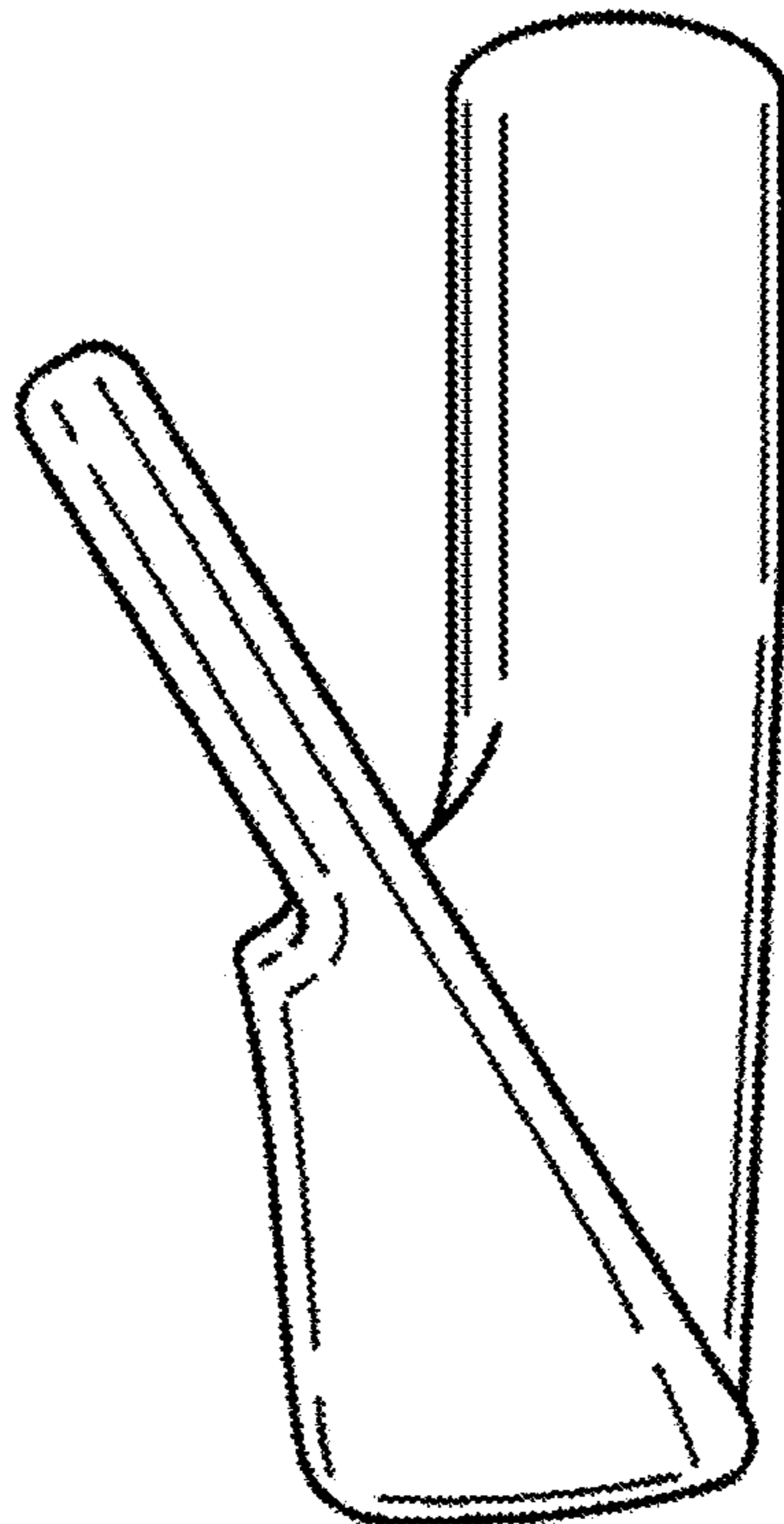
**FIG. 13**



**FIG. 14**



***FIG. 15***



***FIG. 16***