



US00D673527S

(12) **United States Design Patent**
Davies et al.

(10) **Patent No.:** **US D673,527 S**
(45) **Date of Patent:** **** Jan. 1, 2013**

(54) **LOUDSPEAKER**

(75) Inventors: **Simon Davies**, Hong Kong (HK);
Patrick Ho, Hong Kong (HK); **Yang Jack Chang**, New Territories (HK);
Graham Allen, Kent (GB)

(73) Assignee: **GP Acoustics International Limited**,
New Territories (HK)

(**) Term: **14 Years**

(21) Appl. No.: **29/400,353**

(22) Filed: **Aug. 26, 2011**

(51) **LOC (9) Cl.** **14-01**

(52) **U.S. Cl.** **D14/215**

(58) **Field of Classification Search** D14/204,
D14/218, 172, 210-216; 181/143, 147, 148,
181/150, 153, 157, 198, 199, 166, 144;
381/300-303, 306, 332, 333, 336, 345, 361-364,
381/370, 386-388

See application file for complete search history.

(56) **References Cited**

U.S. PATENT DOCUMENTS

3,101,810 A * 8/1963 Doschek 181/199
3,241,631 A * 3/1966 Manieri 181/147
4,221,929 A * 9/1980 Fukuda 381/386

5,546,468 A * 8/1996 Beard 381/86
D486,475 S * 2/2004 Allen D14/215
D505,939 S * 6/2005 Dayan D14/215
D590,812 S * 4/2009 Muraoka et al. D14/215
D593,541 S * 6/2009 Muraoka et al. D14/215
D624,047 S * 9/2010 Kim D14/215

* cited by examiner

Primary Examiner — Prabhakar Deshmukh

(74) *Attorney, Agent, or Firm* — Pearne & Gordon LLP

(57) **CLAIM**

The ornamental design for a loudspeaker, as shown and described.

DESCRIPTION

FIG. 1 is a front view of a loudspeaker showing our new design;

FIG. 2 is a rear view thereof;

FIG. 3 is a left side view thereof;

FIG. 4 is a right side view thereof;

FIG. 5 is a top plan view thereof;

FIG. 6 is a bottom plan view thereof;

FIG. 7 is a front perspective view thereof; and,

FIG. 8 is a rear perspective view thereof.

The broken line showing on the drawing disclosure is for illustrative purposes only and forms no part of the claimed design.

1 Claim, 8 Drawing Sheets

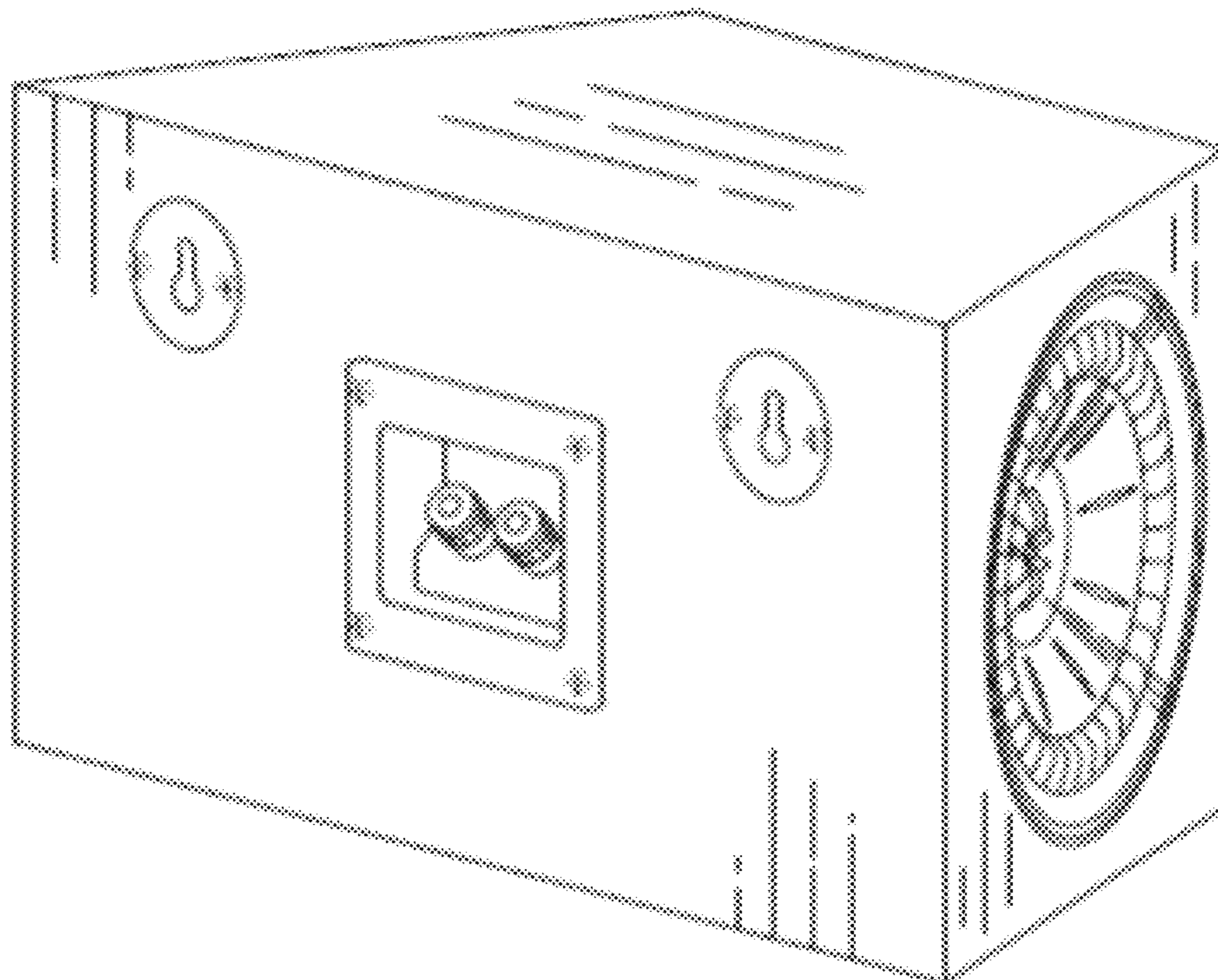

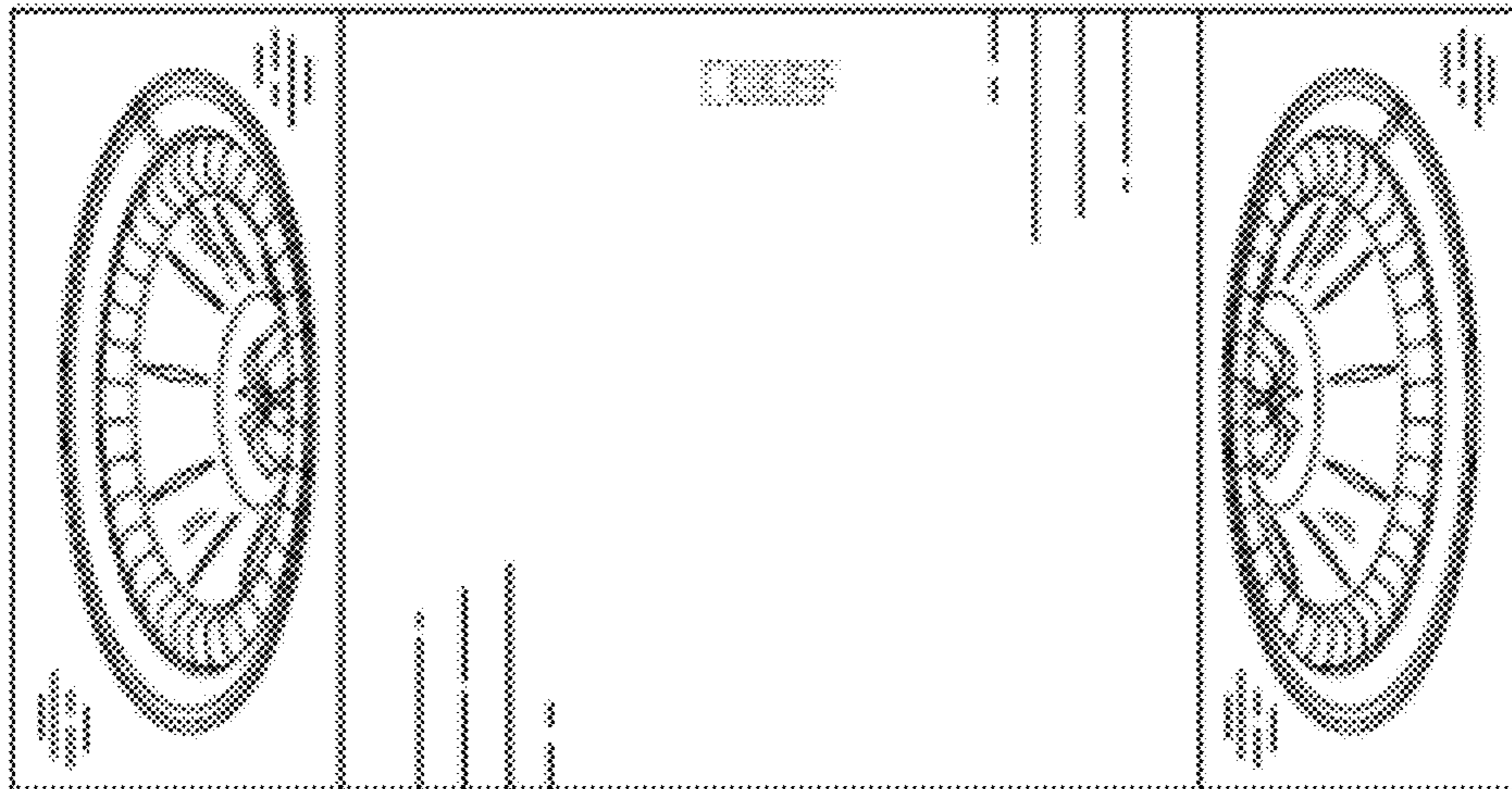

FIG. 1

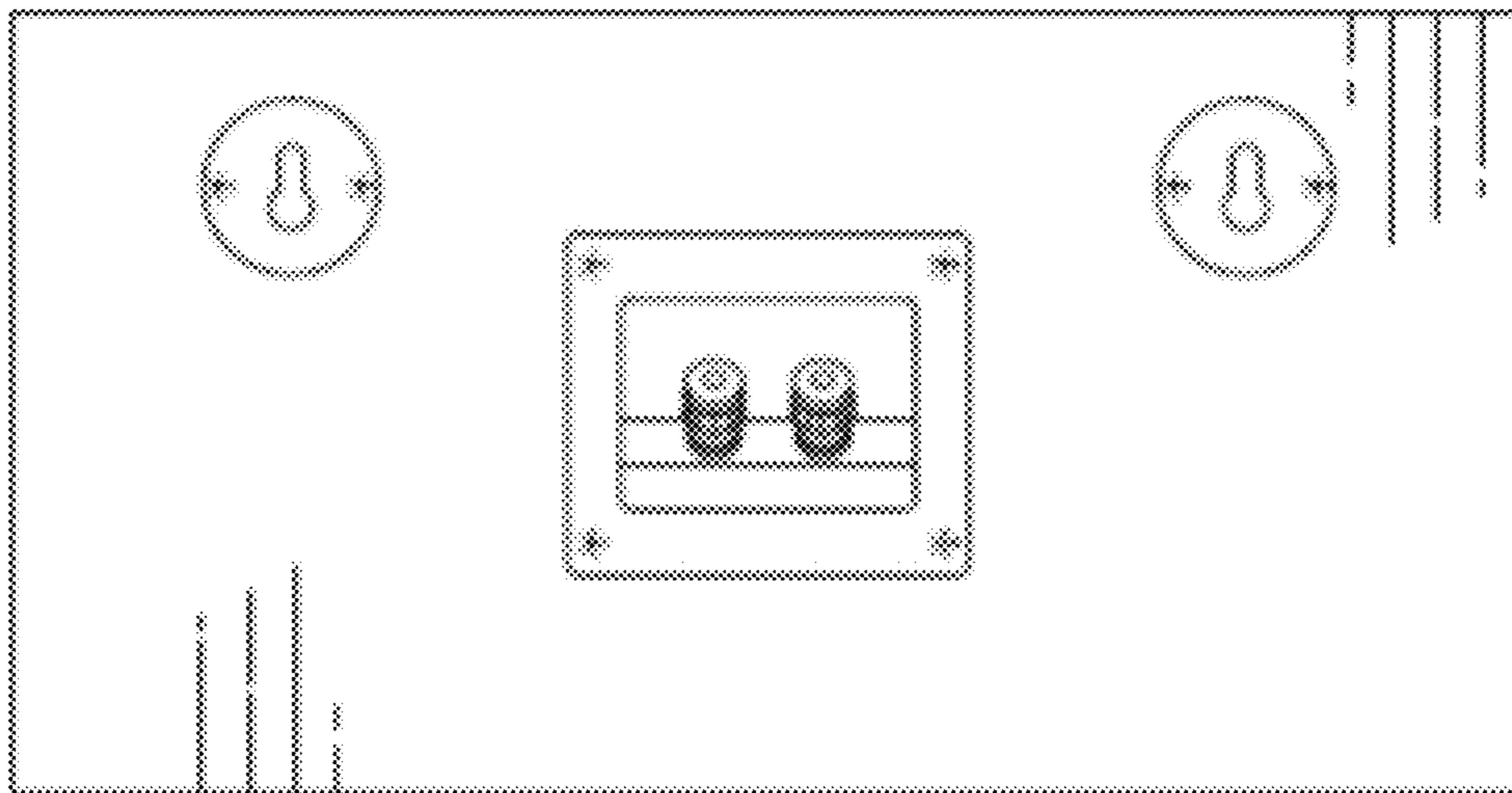

FIG. 2

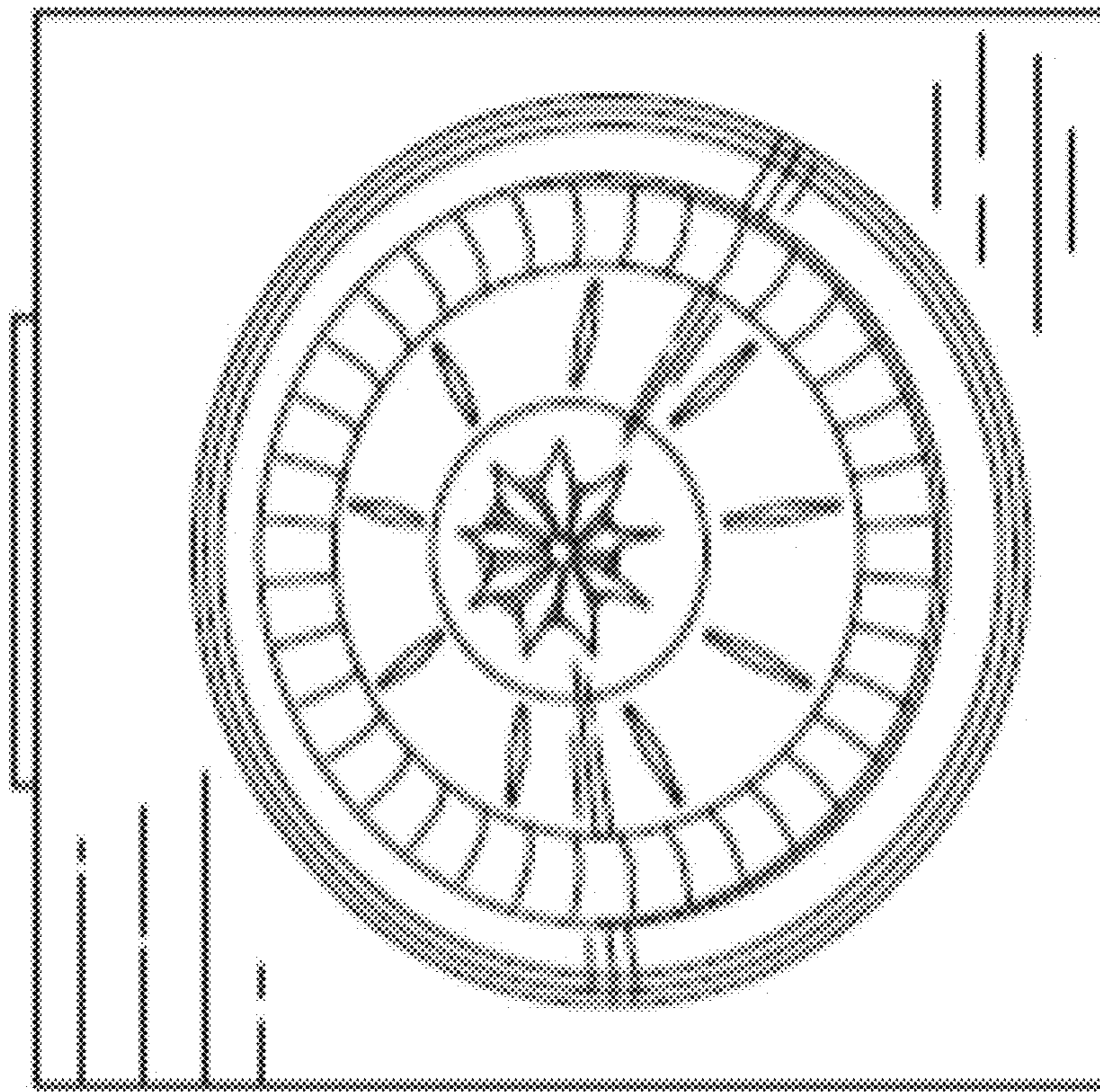

FIG. 3

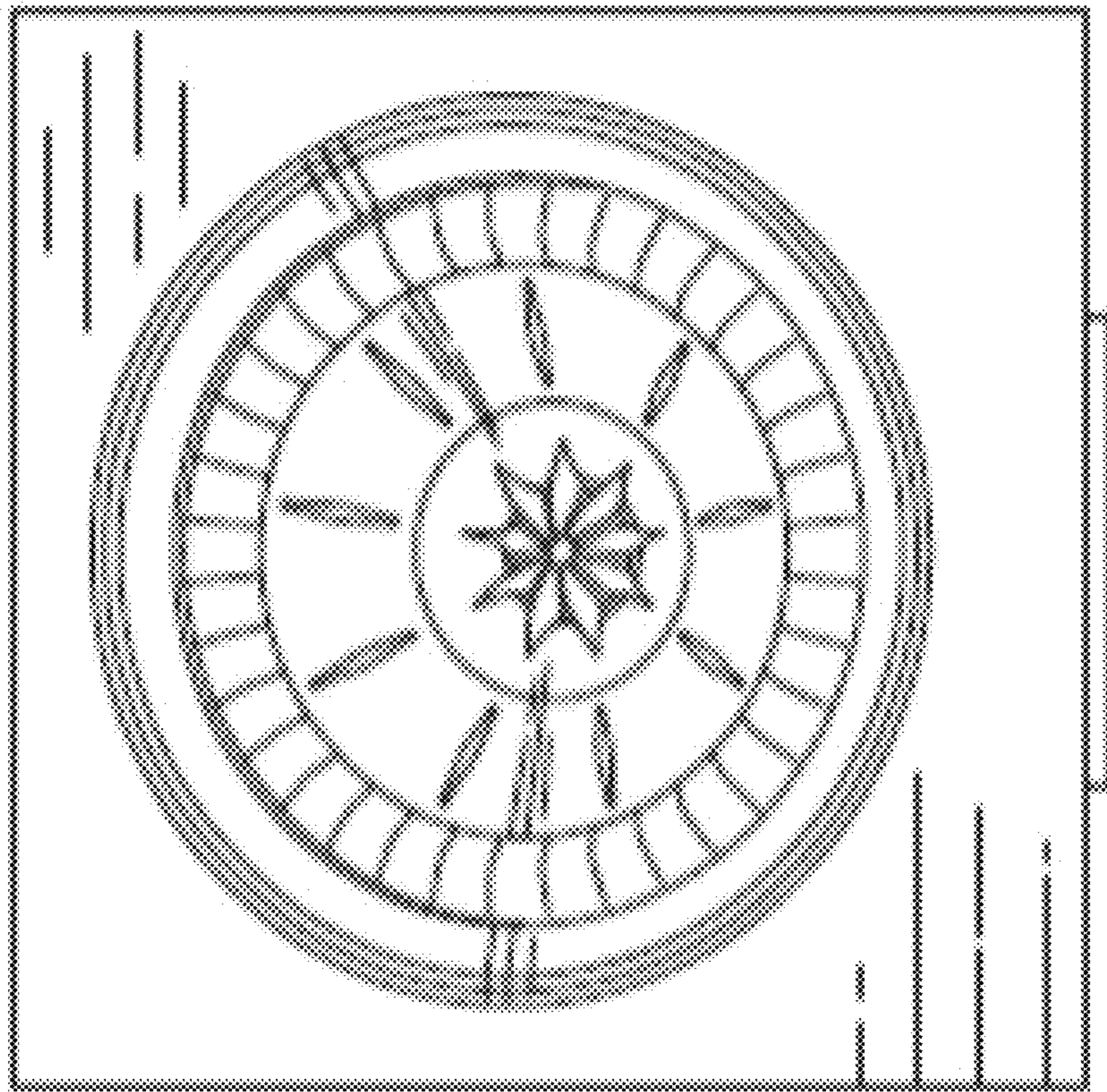

FIG. 4

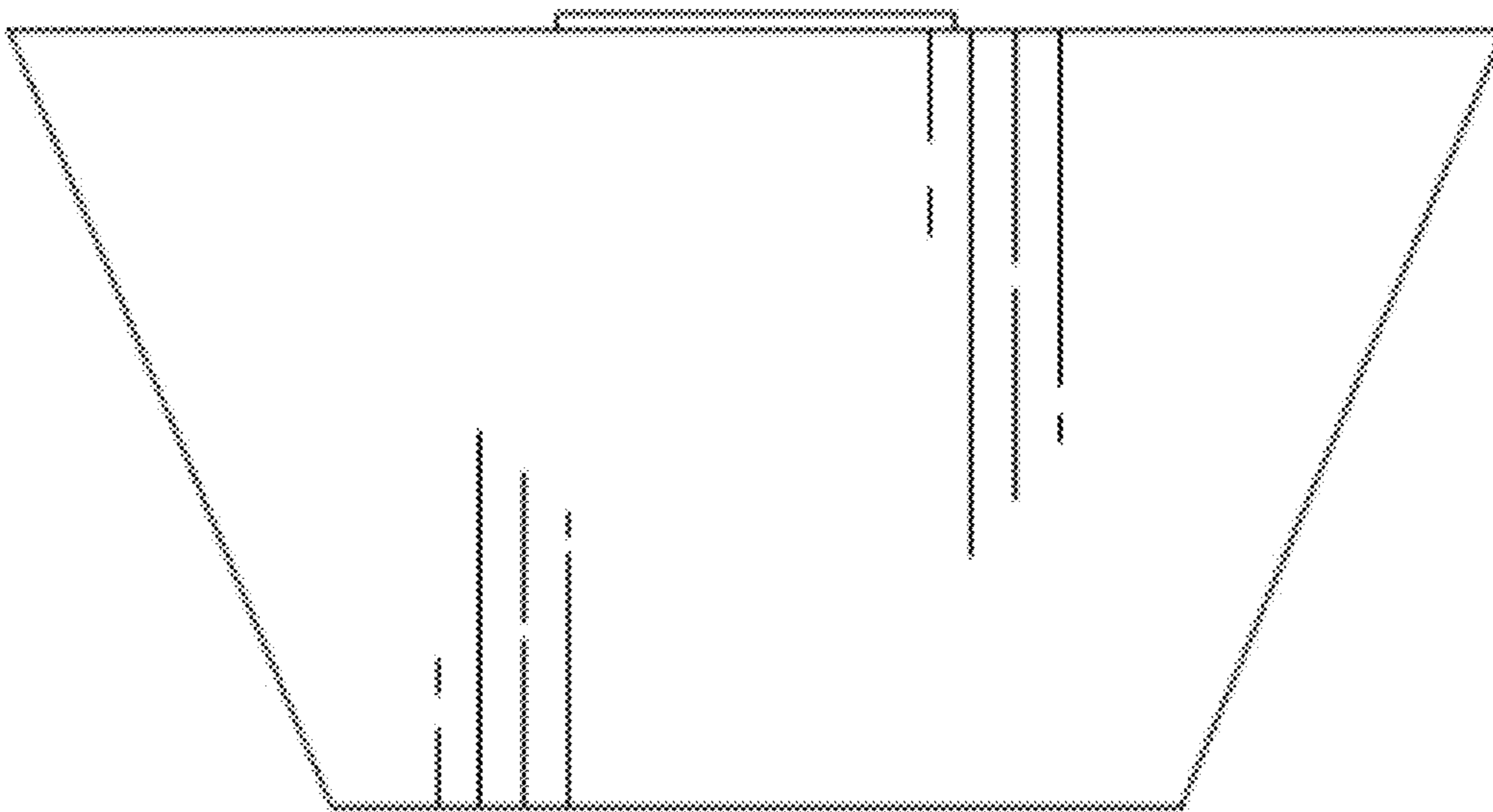

FIG. 5

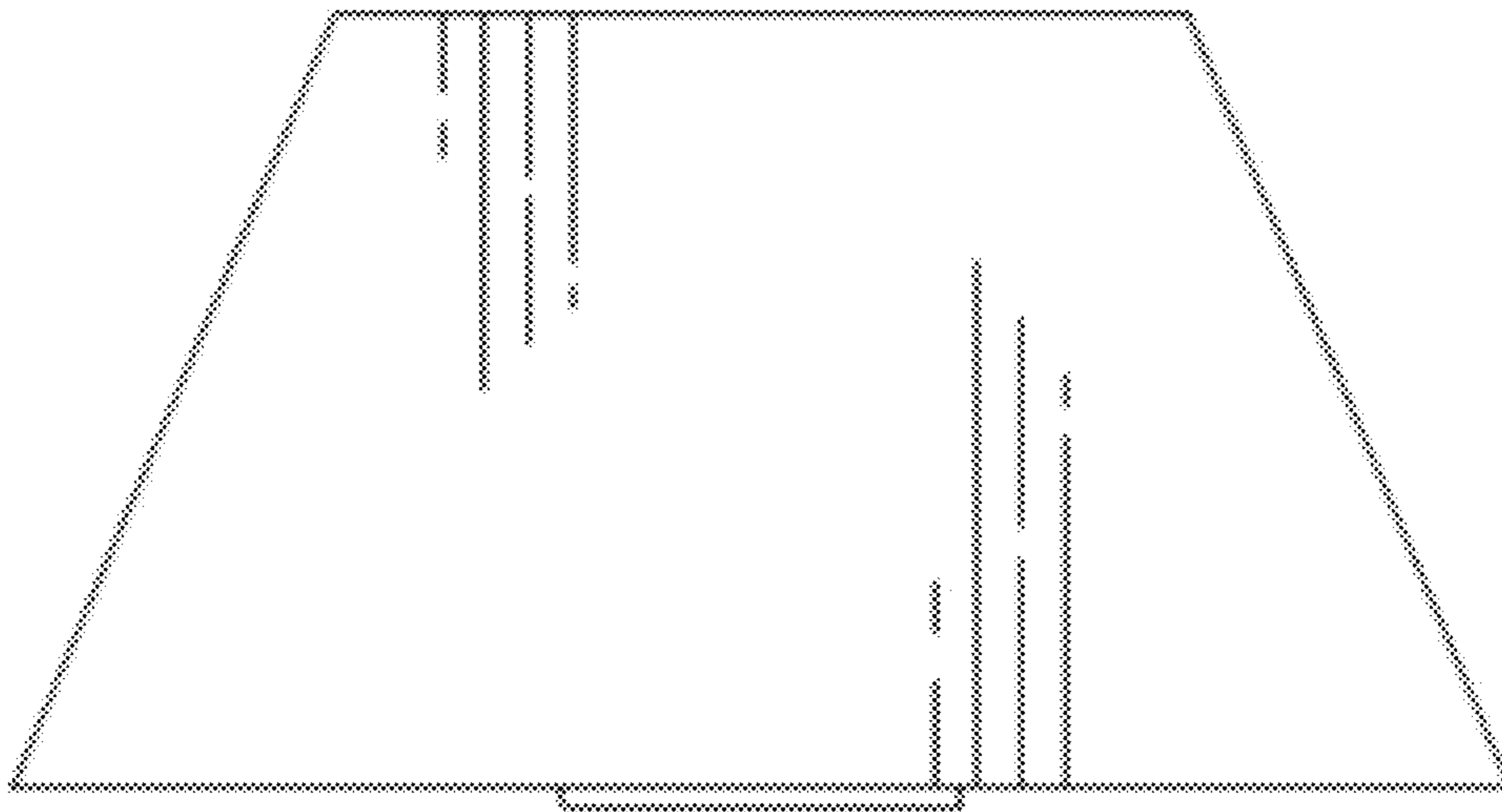

FIG. 6

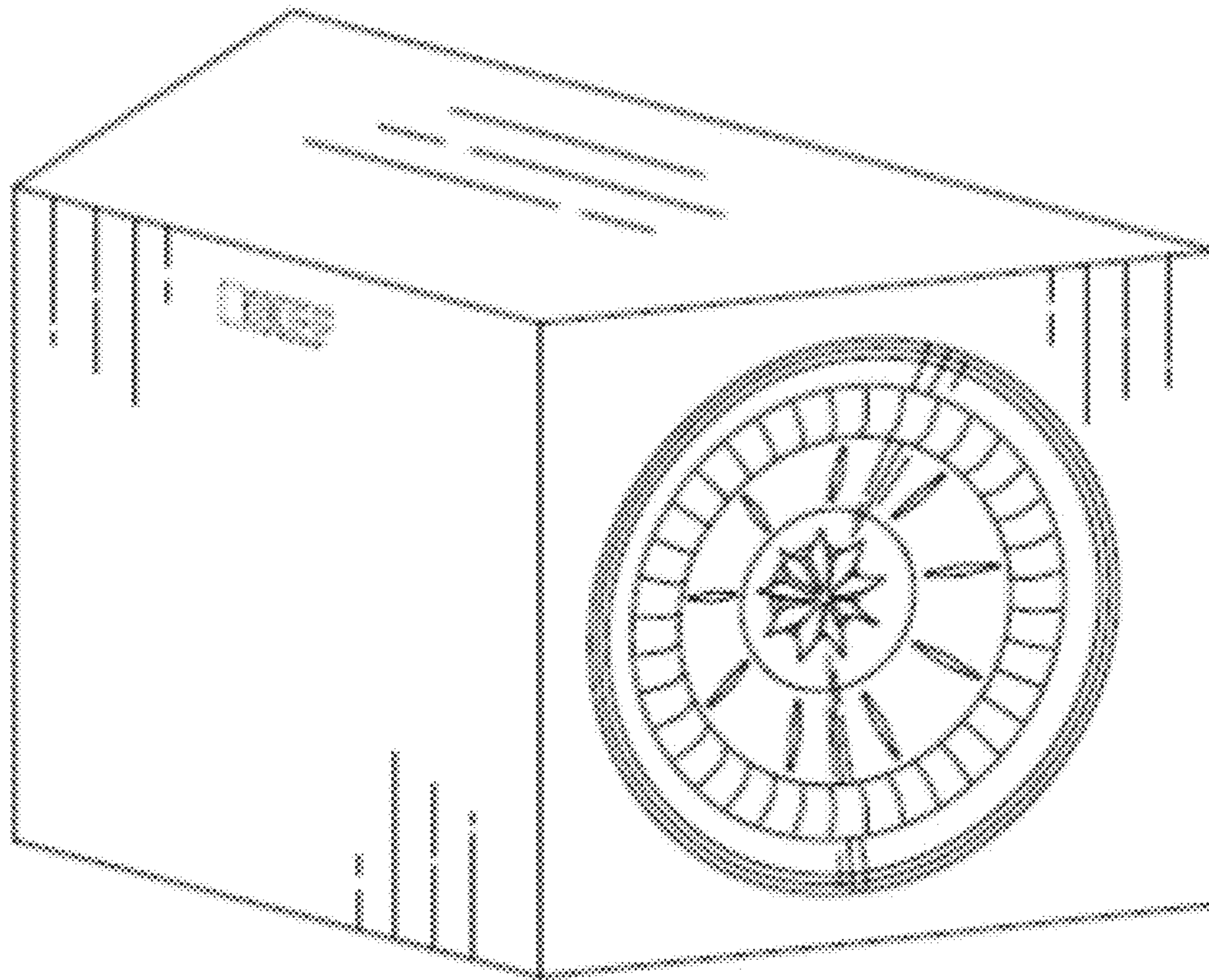

FIG. 7

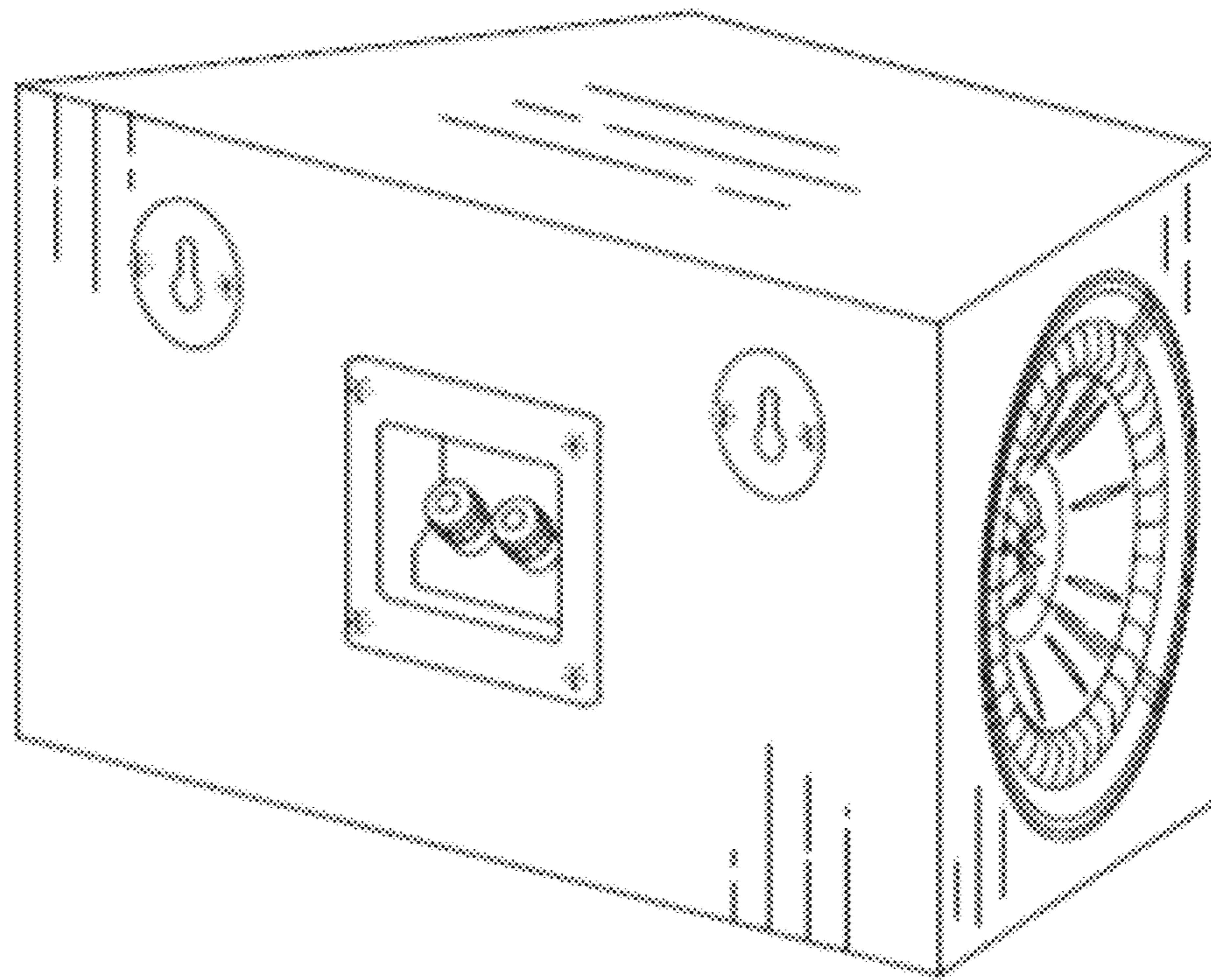

FIG. 8

UNITED STATES PATENT AND TRADEMARK OFFICE
CERTIFICATE OF CORRECTION

PATENT NO. : D673,527 S
APPLICATION NO. : 29/400353
DATED : January 1, 2013
INVENTOR(S) : Simon Davies et al.

Page 1 of 1

It is certified that error appears in the above-identified patent and that said Letters Patent is hereby corrected as shown below:

Title page, between (22) and (51), should list --(30) Foreign Application Priority Data
August 12, 2011 (HK) 1101376.0M001-M009--

Signed and Sealed this
Nineteenth Day of February, 2013



Teresa Stanek Rea
Acting Director of the United States Patent and Trademark Office