



US00D673507S

(12) **United States Design Patent**
Morishita et al.

(10) **Patent No.:** **US D673,507 S**
(45) **Date of Patent:** **** Jan. 1, 2013**

(54) **PROTECTIVE RELAY**

(75) Inventors: **Fumihito Morishita**, Tokyo (JP);
Yukinari Furuhata, Tokyo (JP); **Takeo Kamosaki**, Tokyo (JP)

(73) Assignee: **Fuji Electric FA Components & Systems Co., Ltd**, Tokyo (JP)

(**) Term: **14 Years**

(21) Appl. No.: **29/397,316**

(22) Filed: **Jul. 14, 2011**

(30) **Foreign Application Priority Data**

Jan. 14, 2011 (JP) D2011-000604

(51) **LOC (9) Cl.** **13-03**

(52) **U.S. Cl.** **D13/159**

(58) **Field of Classification Search** D13/158,
D13/159, 160, 162, 184, 199; 200/43.14,
200/50.01, 50.21-50.23; 361/42, 44, 50,
361/71, 115, 608, 634

See application file for complete search history.

(56) **References Cited**

U.S. PATENT DOCUMENTS

D323,815 S * 2/1992 Bouteiller D13/159
D370,465 S * 6/1996 Yee et al. D13/159
D592,152 S * 5/2009 Lin D13/159
D608,299 S * 1/2010 Shin D13/160

D640,990 S * 7/2011 Detemple et al. D13/159
D641,325 S * 7/2011 Detemple et al. D13/159
D642,131 S * 7/2011 Detemple et al. D13/159
D653,625 S * 2/2012 Detemple et al. D13/159
D656,467 S * 3/2012 Okubo et al. D13/159
D656,905 S * 4/2012 Okubo et al. D13/159
2010/0245021 A1* 9/2010 Furuhata et al. 337/112
2010/0253467 A1* 10/2010 Kamosaki et al. 337/85

* cited by examiner

Primary Examiner — Thomas Johannes

(74) *Attorney, Agent, or Firm* — Young & Thompson

(57) **CLAIM**

The ornamental design for a protective relay, as shown and described.

DESCRIPTION

FIG. 1 is a perspective view of rear, bottom and right side of a protective relay showing our new design;
FIG. 2 is a front view thereof;
FIG. 3 is a rear view thereof;
FIG. 4 is a top plan view thereof;
FIG. 5 is a bottom view thereof;
FIG. 6 is a left side view thereof;
FIG. 7 is a right side view thereof; and,
FIG. 8 is a perspective view where a front cover is opened.
The portions of the article in broken lines show unclaimed subject matter only and form no part of the claimed design.

1 Claim, 8 Drawing Sheets

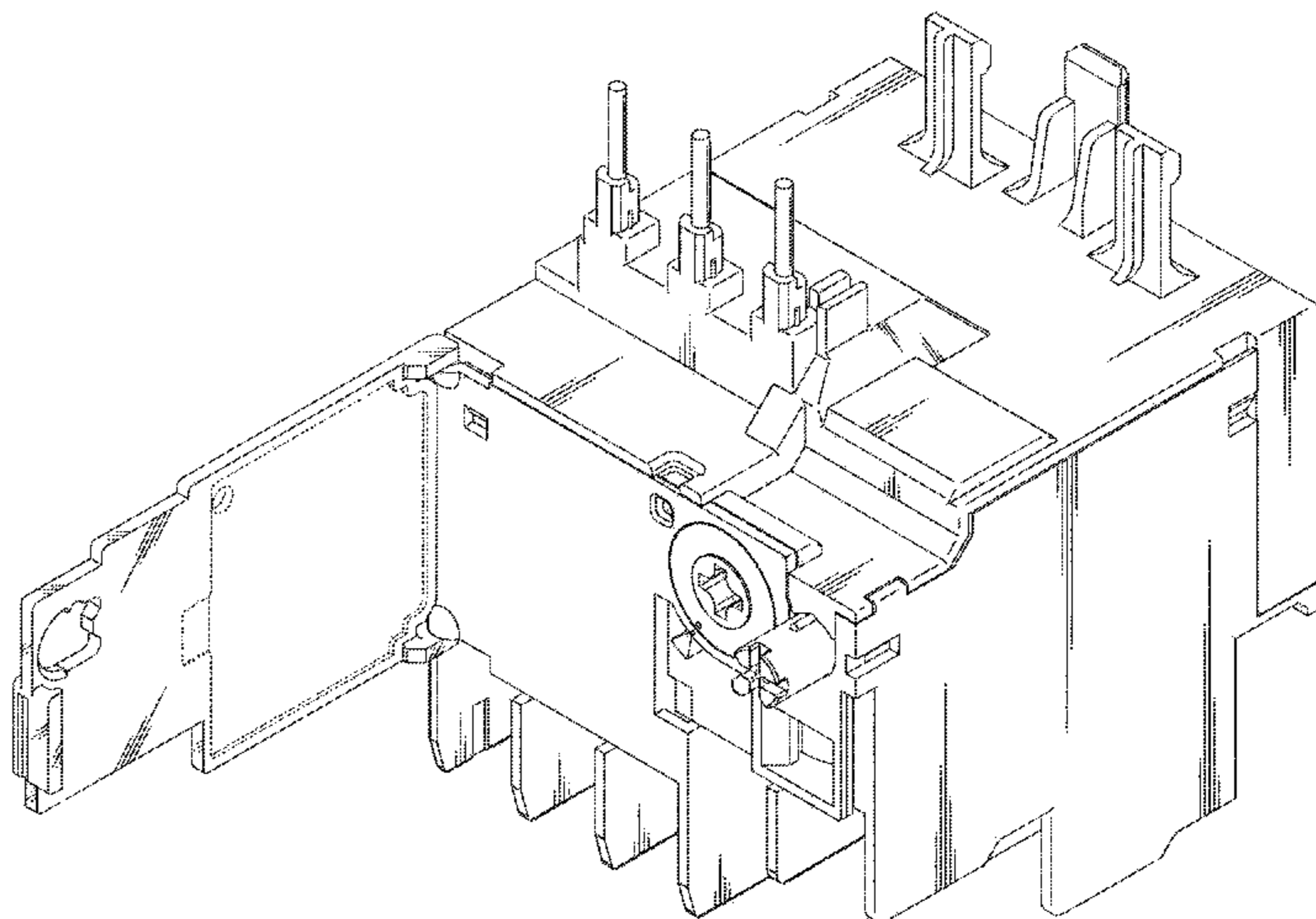
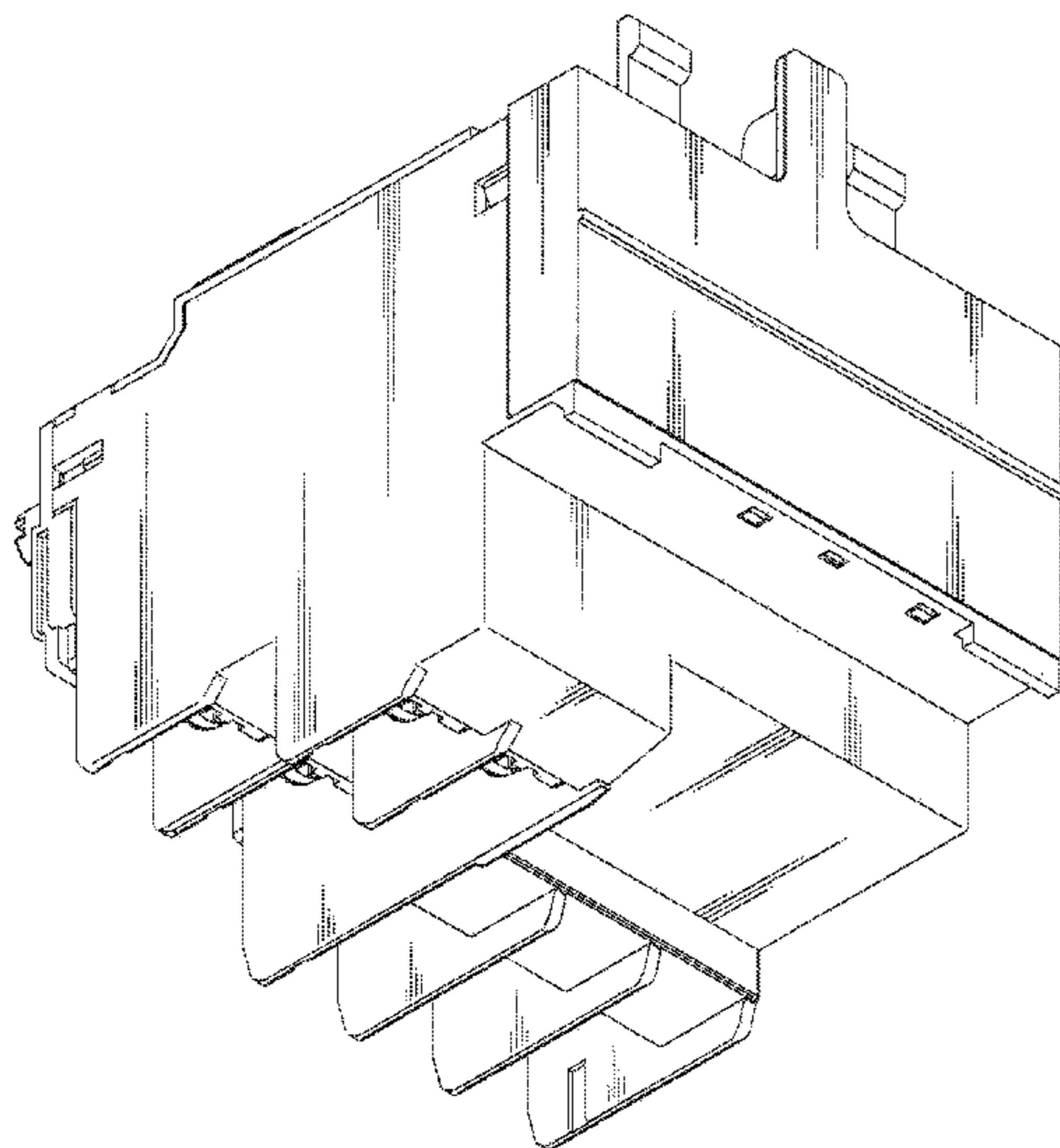

Fig. 1

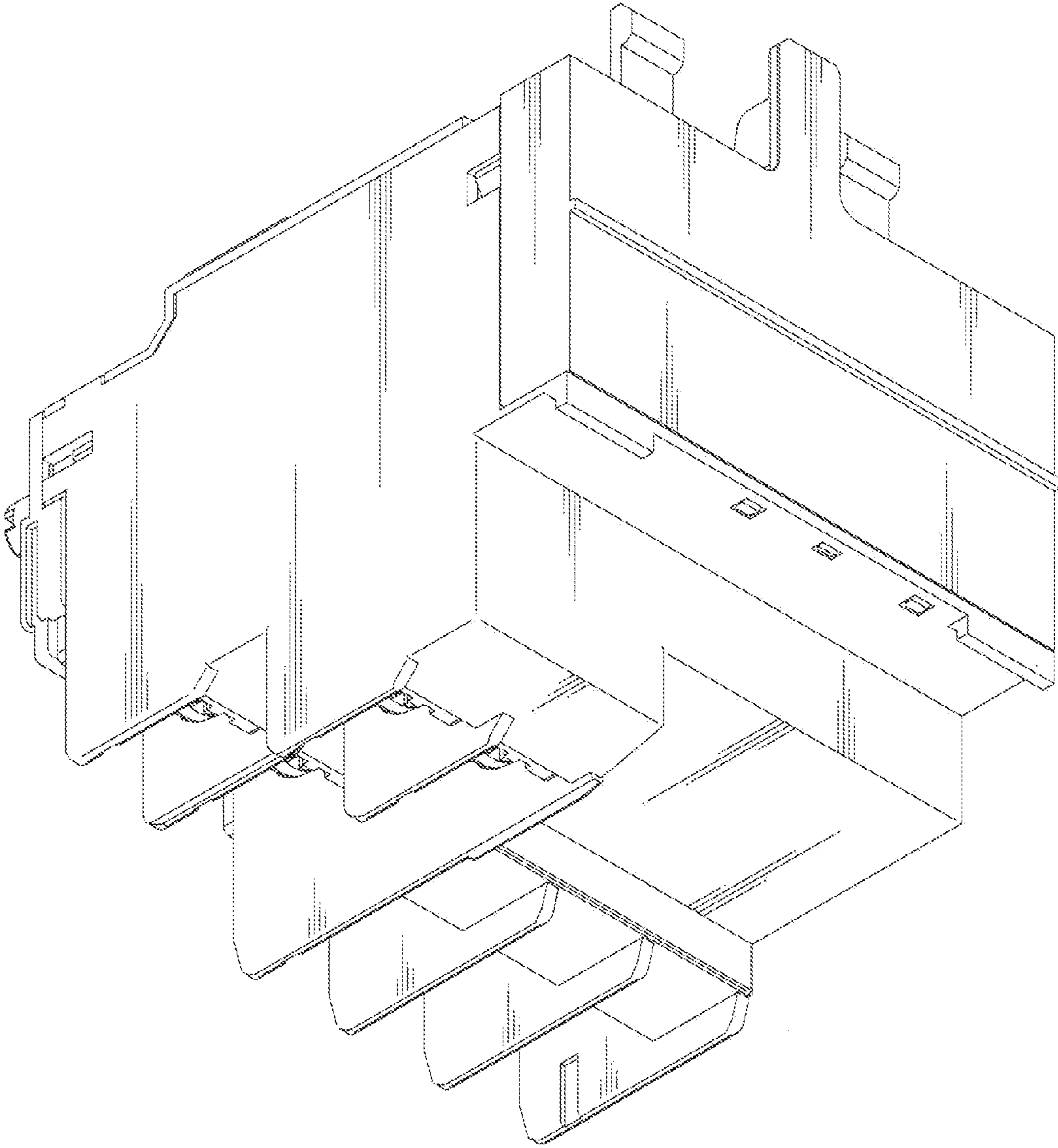

Fig. 2

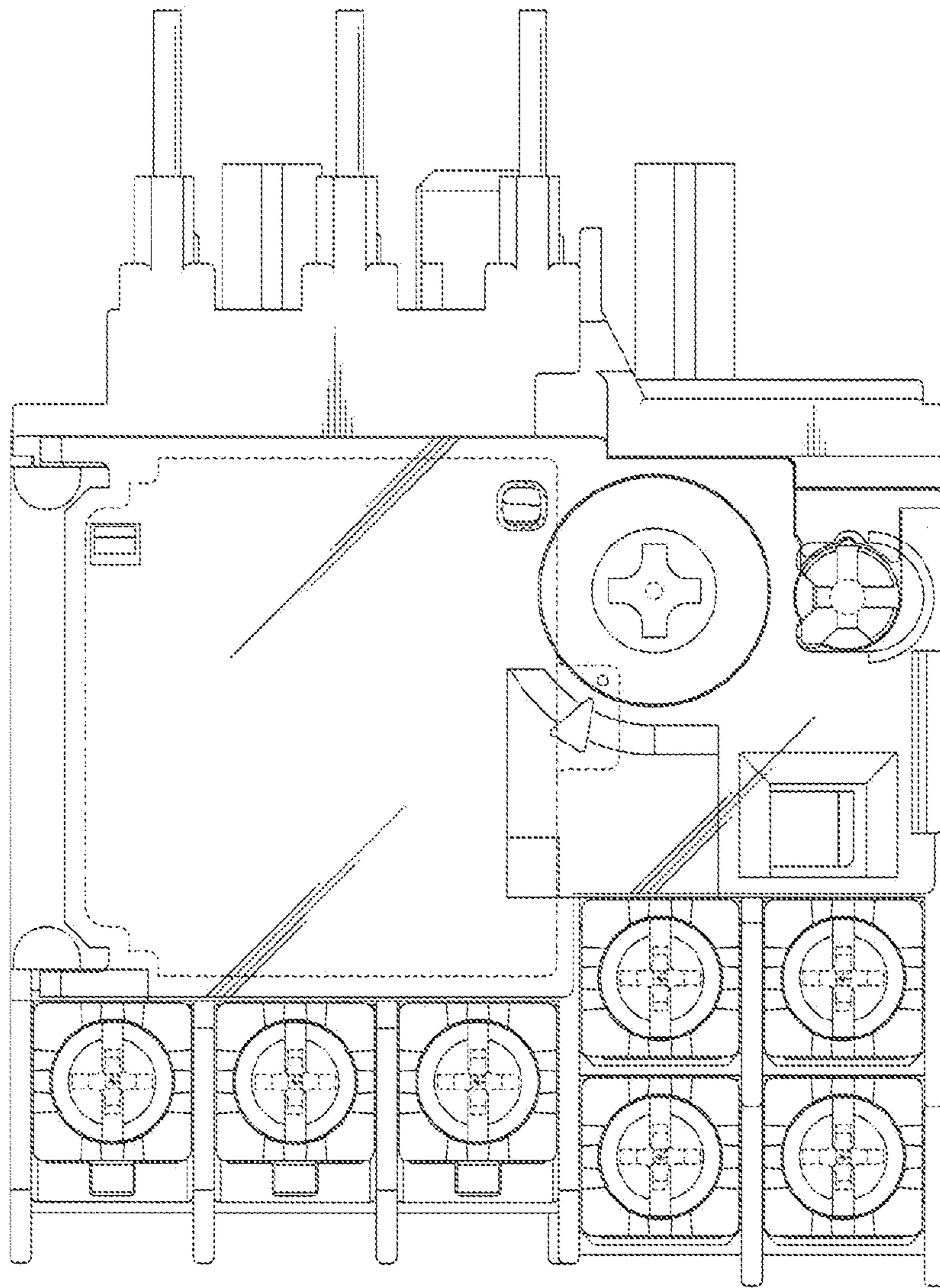

Fig. 3

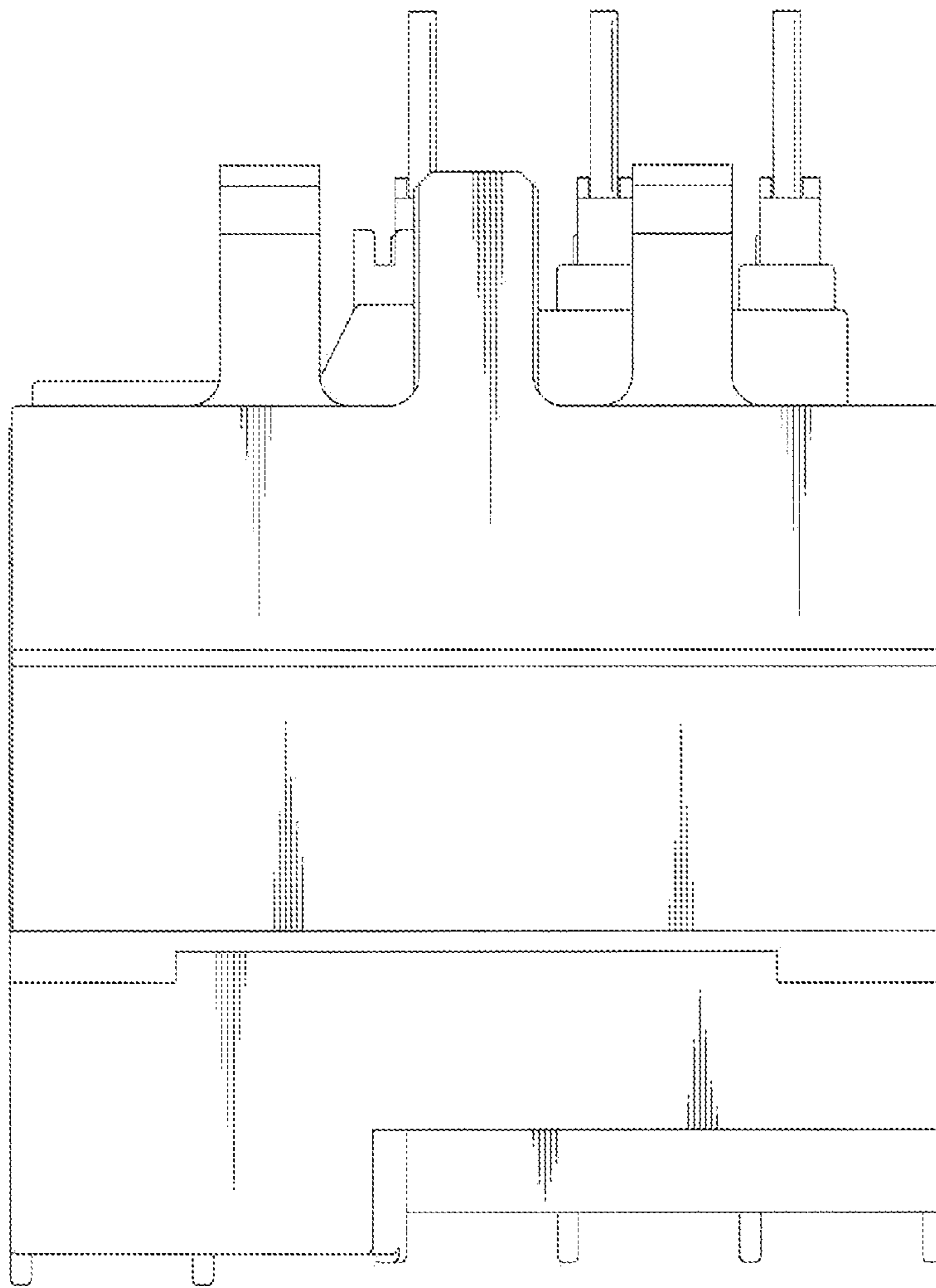

Fig. 4

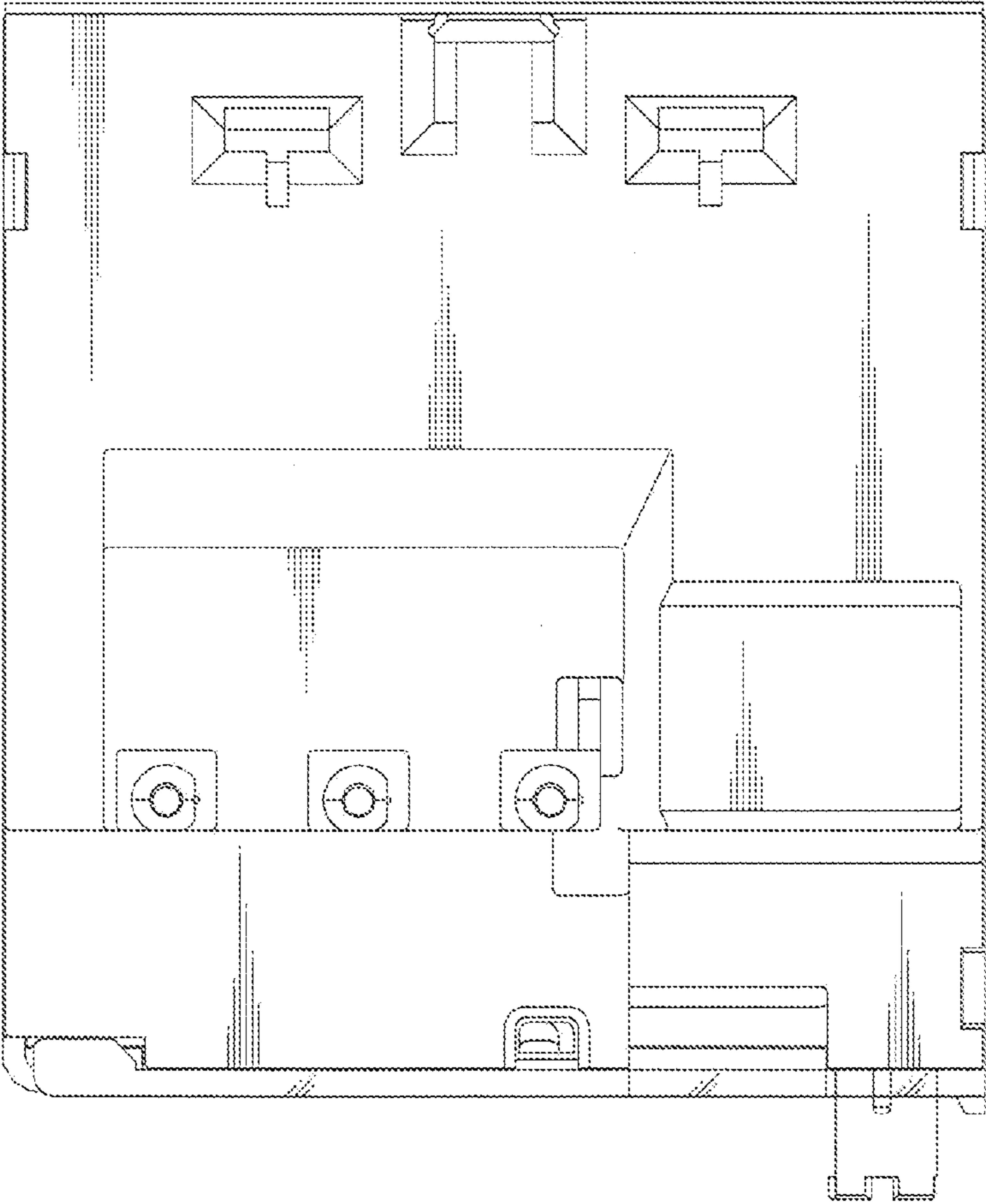

Fig. 5

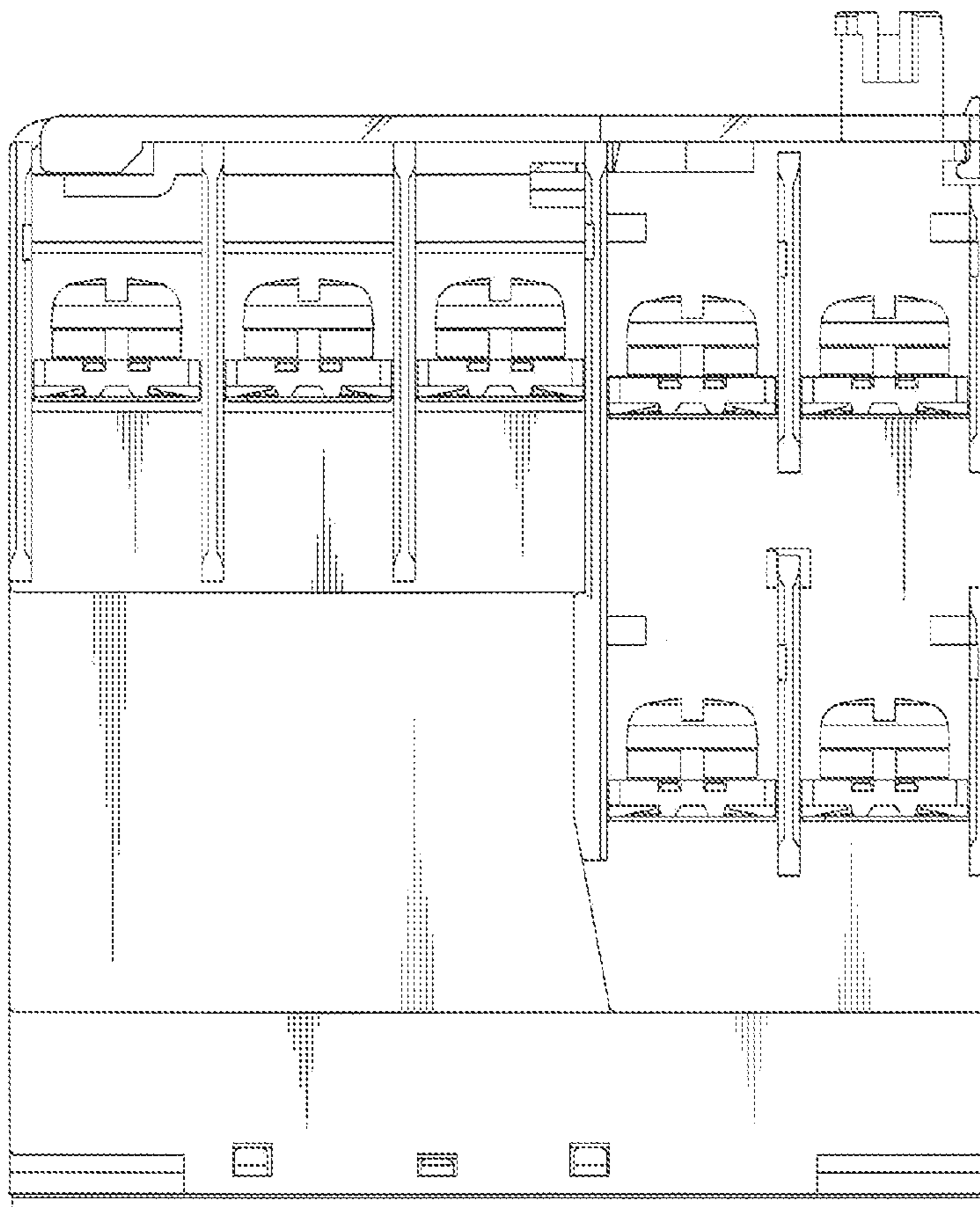

Fig. 6

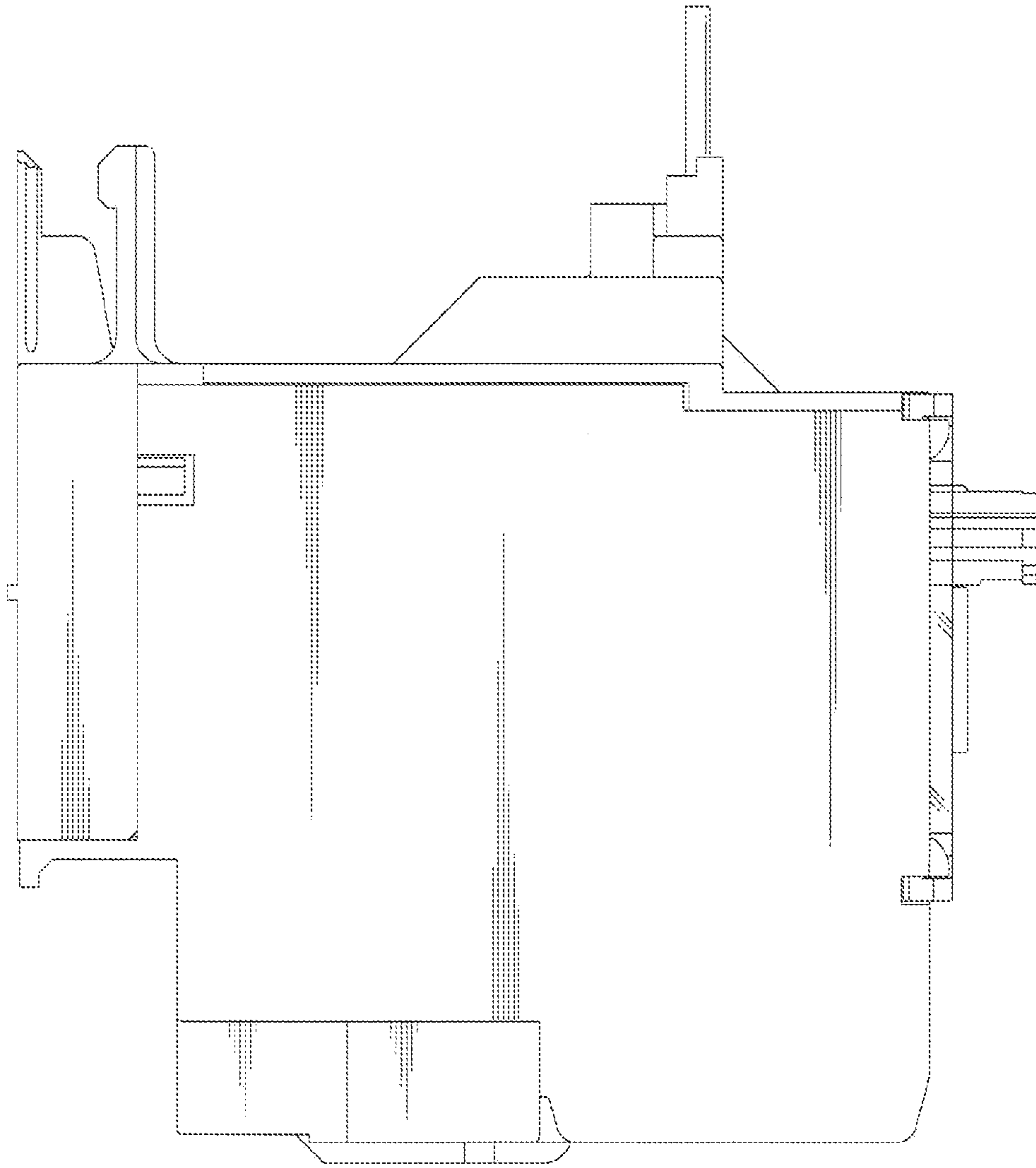

Fig. 7

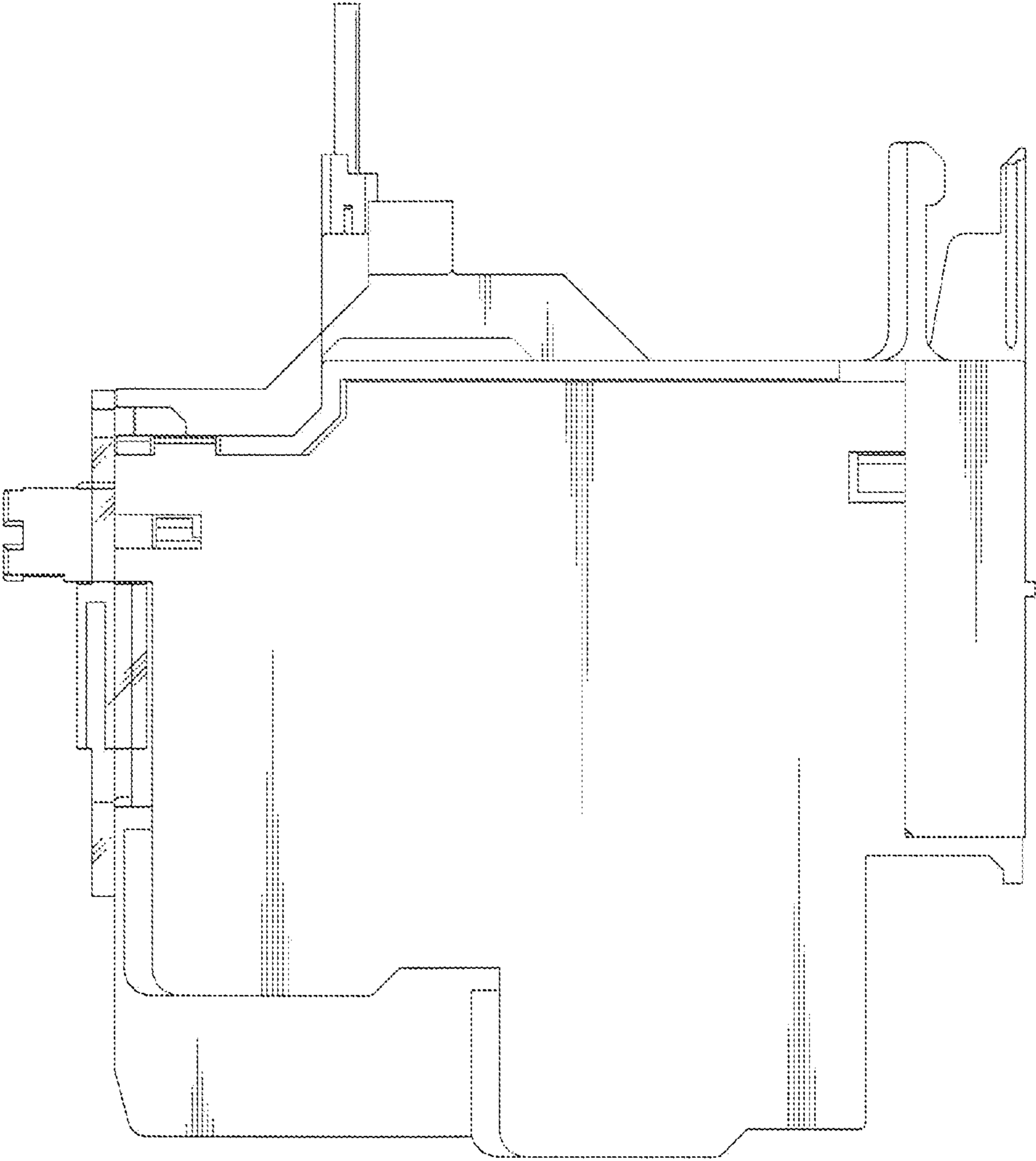

Fig. 8

