



US00D673389S

(12) **United States Design Patent**
Pazhoor

(10) **Patent No.:** **US D673,389 S**
(45) **Date of Patent:** **** Jan. 1, 2013**

(54) **PORTABLE MULTI-STATION VOTING
BOOTH CART**

DESCRIPTION

(75) Inventor: **Mohamed S Pazhoor**, West Palm Beach, FL (US)

(73) Assignee: **Naztec International Group LLC**, West Palm Beach, FL (US)

(**) Term: **14 Years**

(21) Appl. No.: **29/411,754**

(22) Filed: **Jan. 25, 2012**

(51) **LOC (9) Cl.** **06-03**

(52) **U.S. Cl.** **D6/397; D6/421; D6/445**

(58) **Field of Classification Search** D6/419-428,
D6/429-431, 445, 446, 397; 312/194-196,
312/198, 6, 262, 122, 294, 237, 257.1; 108/50.01,
108/50.02, 60; 235/51, 50 R; 52/36.1, 36.4;
160/135

See application file for complete search history.

(56) **References Cited**

U.S. PATENT DOCUMENTS

D216,991	S	*	3/1970	Gianfagua	D6/421
3,550,540	A	*	12/1970	Harris et al.	108/23
D300,487	S	*	4/1989	Dyer	D6/446
D379,566	S	*	6/1997	Ewens et al.	D6/445
D603,621	S	*	11/2009	Abel et al.	D6/421
D616,667	S	*	6/2010	Pazhoor	D6/421
8,006,986	B1	*	8/2011	Pazhoor	280/47.34
2009/0166992	A1	*	7/2009	Abel et al.	280/47.35

* cited by examiner

Primary Examiner — Janice Seeger

(57) **CLAIM**

The Ornamental design for a portable multi-station voting booth cart, as shown and described.

FIG. 1 is a front perspective view of the portable multi-station voting booth cart of the instant invention with wide and short trays in deployed configuration. The short tray itself consists of primary and secondary tray shown deployed in this configuration;

FIG. 2 is a front view thereof;

FIG. 3 is a rear view thereof;

FIG. 4 is a right side view thereof;

FIG. 5 is a left side view thereof;

FIG. 6 is a top view thereof;

FIG. 7 is a bottom view thereof;

FIG. 8 is a front perspective view of the portable multi-station voting booth cart of the instant invention with wide and short trays in deployed configuration. The secondary tray of the short trays is shown as closed in this configuration;

FIG. 9 is a front view thereof;

FIG. 10 is a rear view thereof;

FIG. 11 is a right side view thereof;

FIG. 12 is a left side view thereof;

FIG. 13 is a top view thereof;

FIG. 14 is a bottom view thereof;

FIG. 15 is a front perspective view of the portable multi-station voting booth cart of the instant invention with wide and short trays in closed configuration;

FIG. 16 is a front view thereof;

FIG. 17 is a rear view thereof;

FIG. 18 is a right side view thereof;

FIG. 19 is a left side view thereof;

FIG. 20 is a top view thereof; and,

FIG. 21 is a bottom view thereof.

The portions of the figures illustrated in broken lines are for illustrative purposes only and no part of the claimed subject matter.

1 Claim, 21 Drawing Sheets

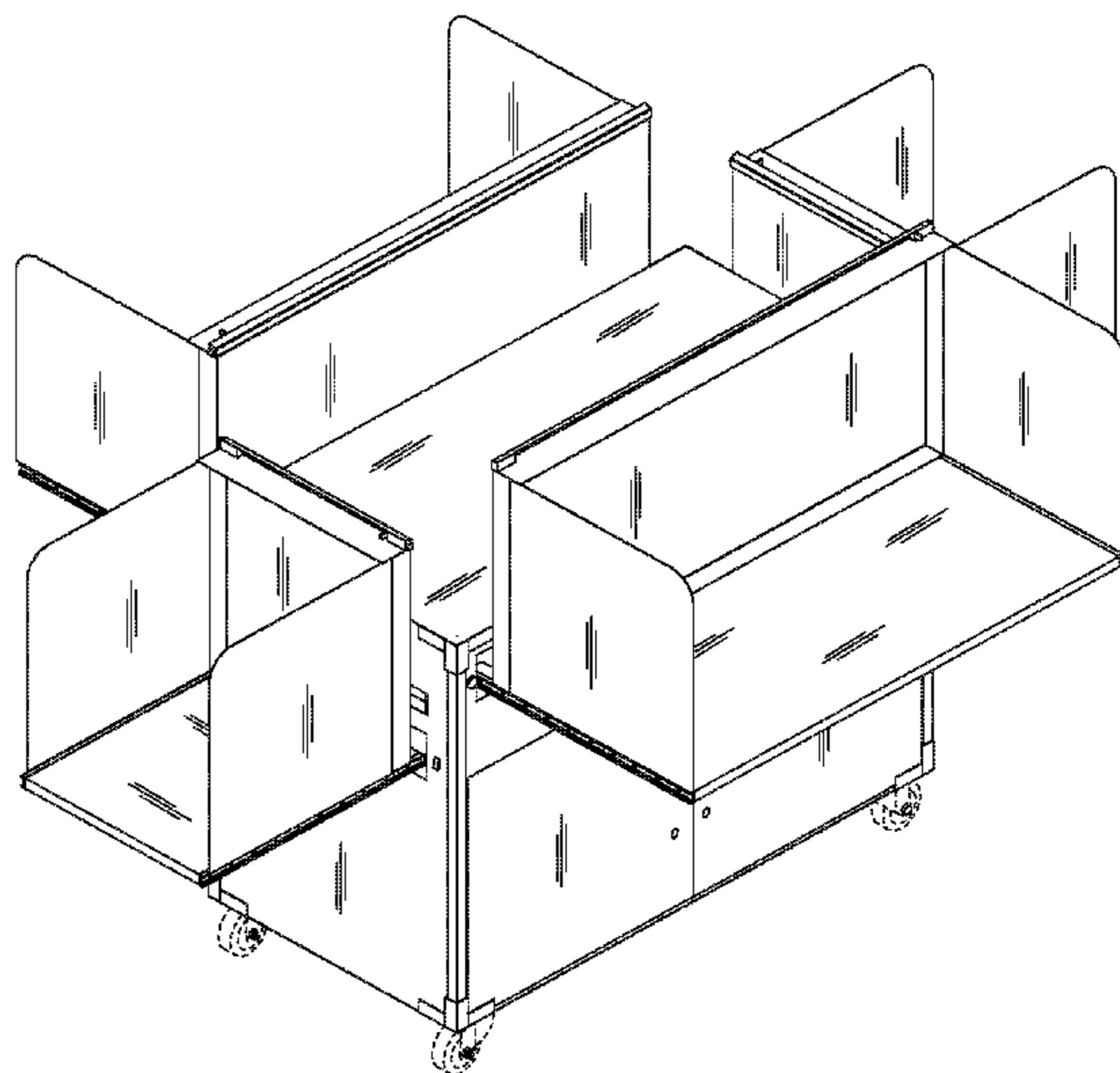
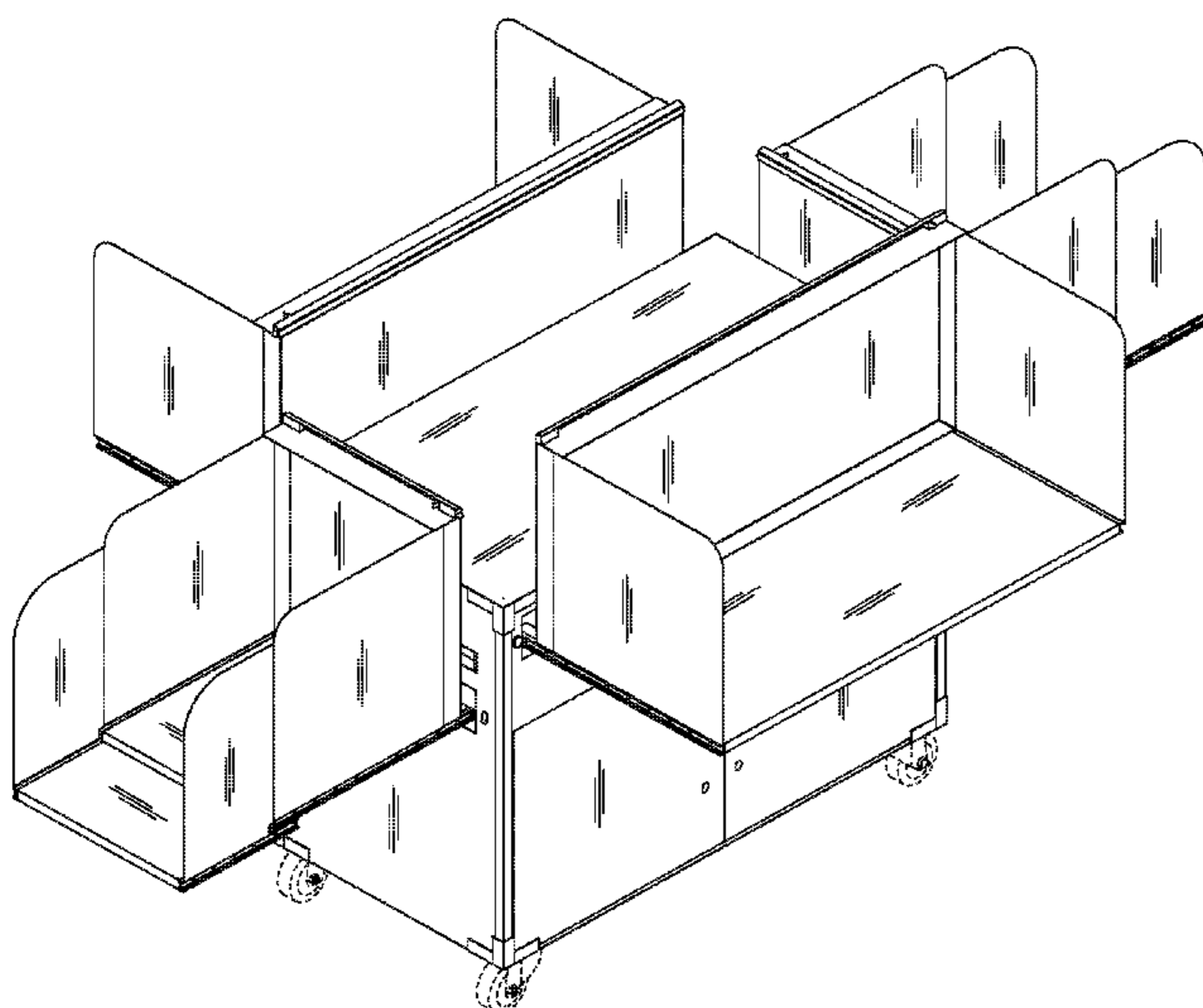

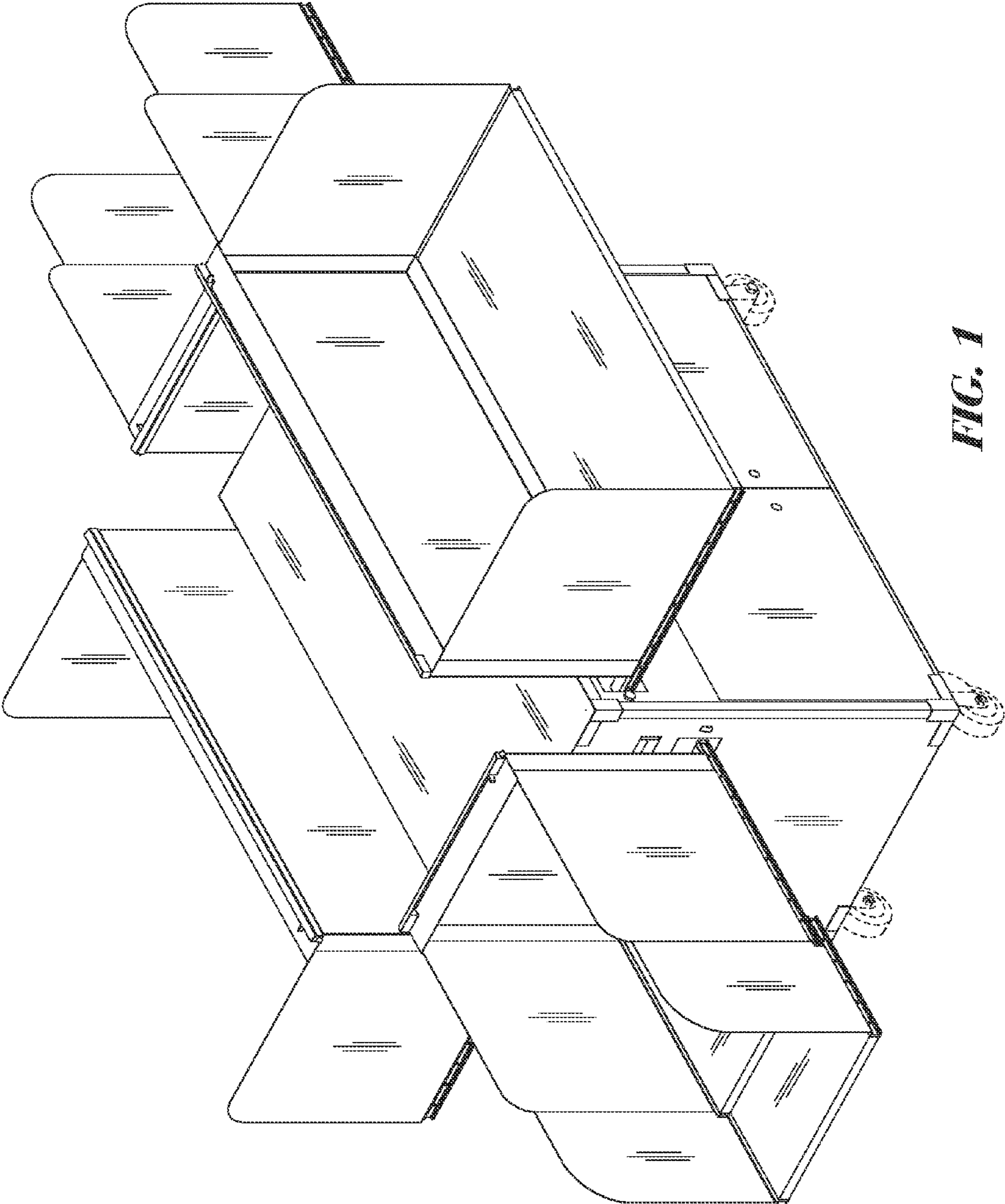

FIG. 1

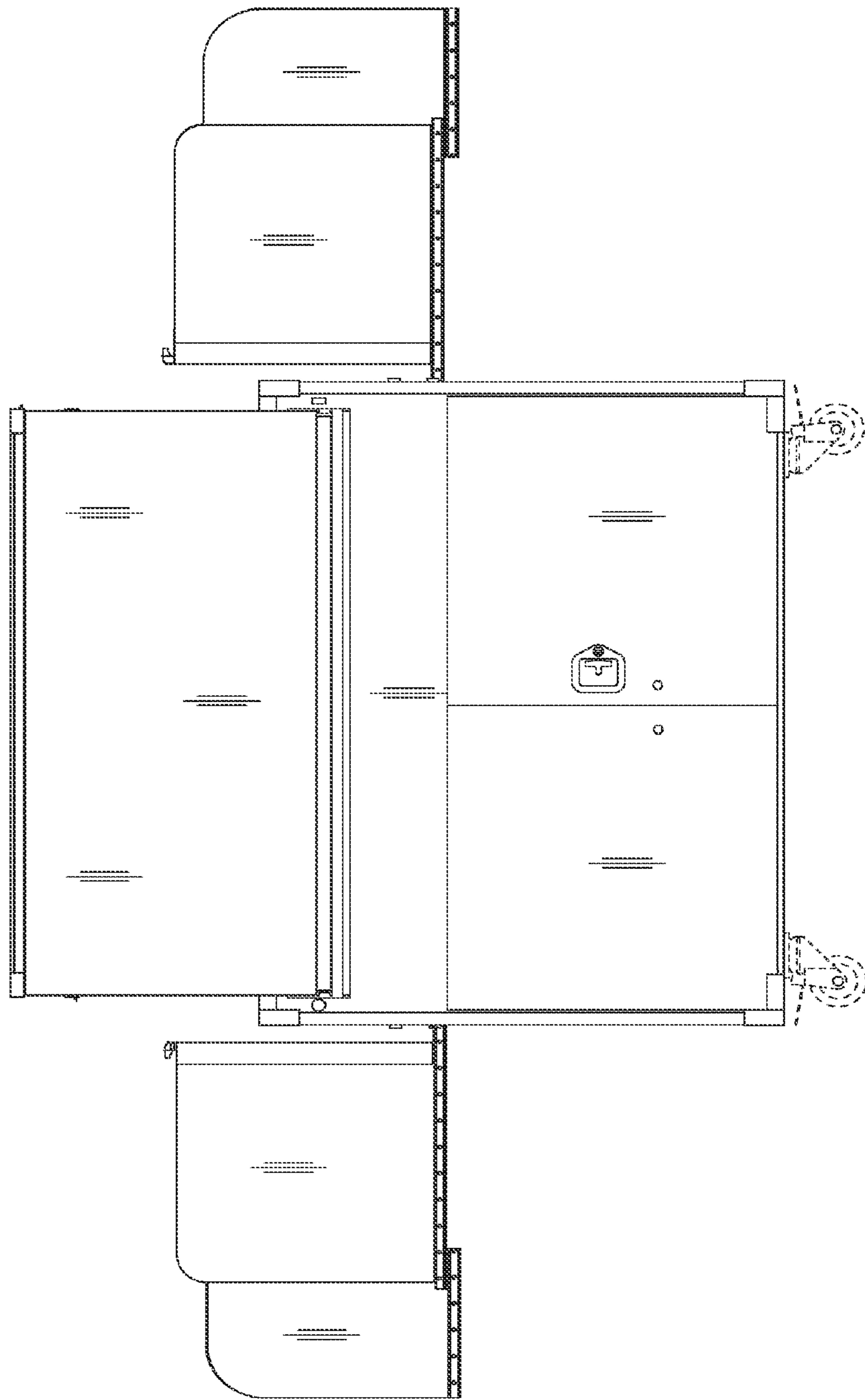

FIG. 2

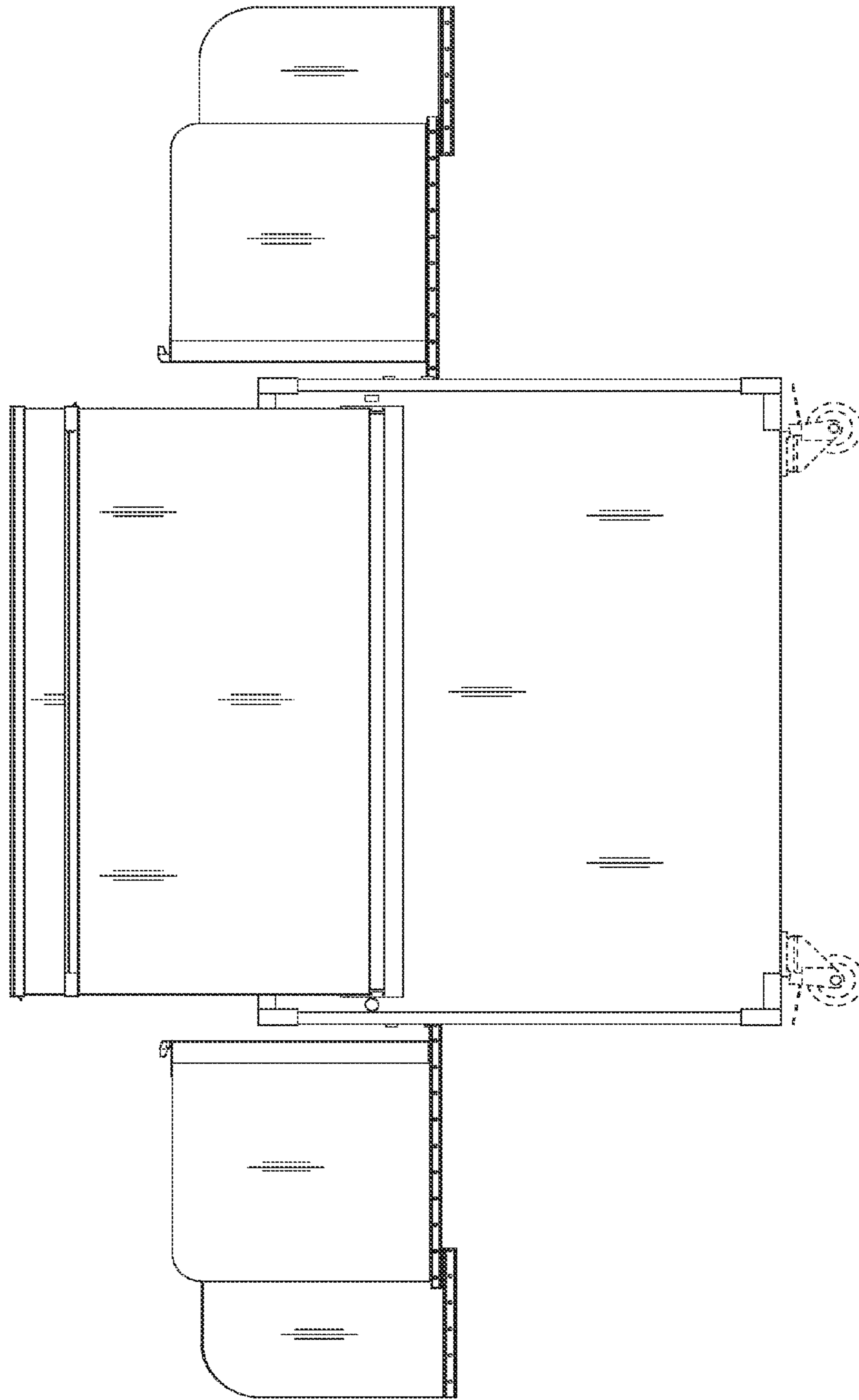

FIG. 3

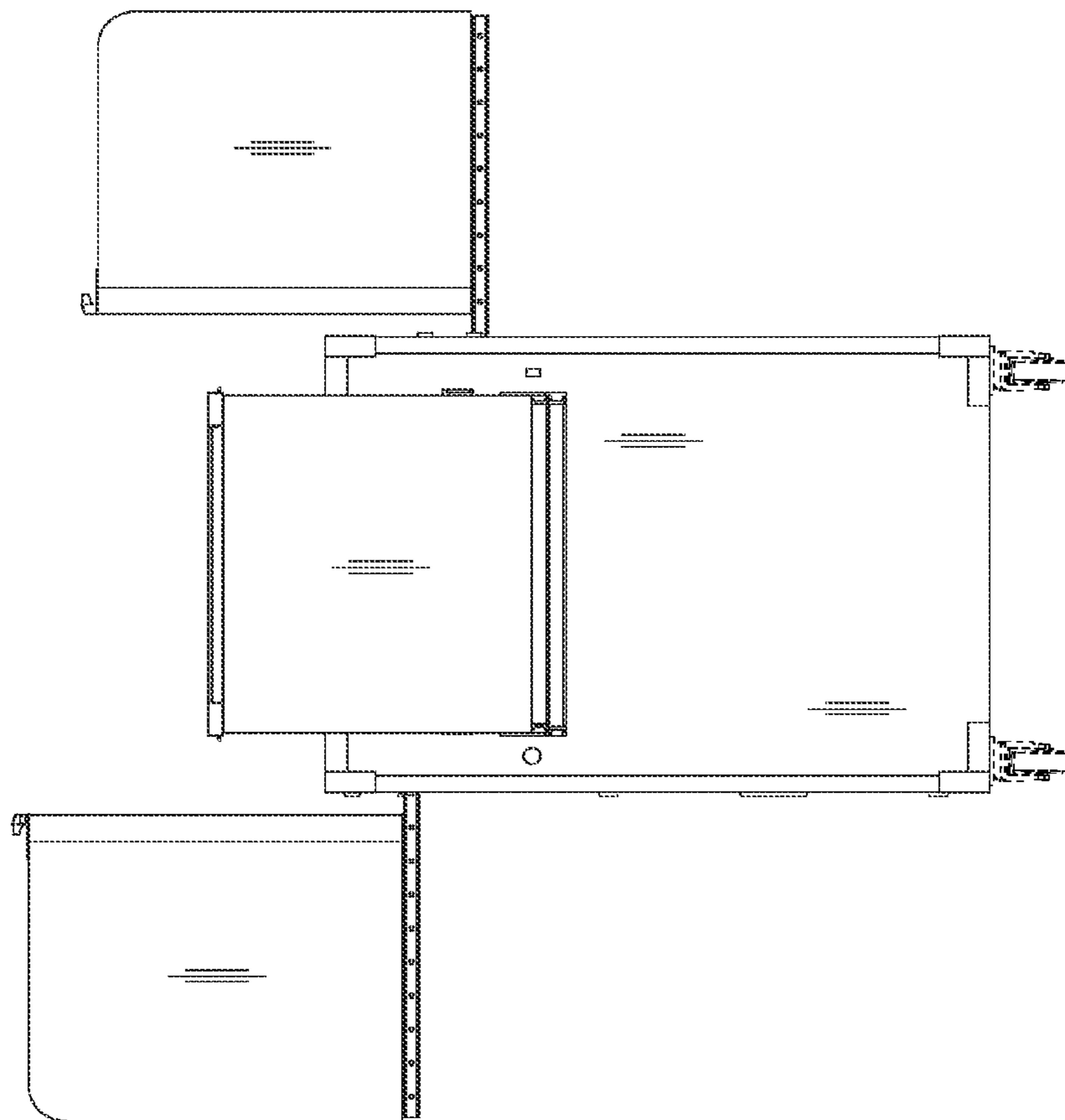

FIG. 4

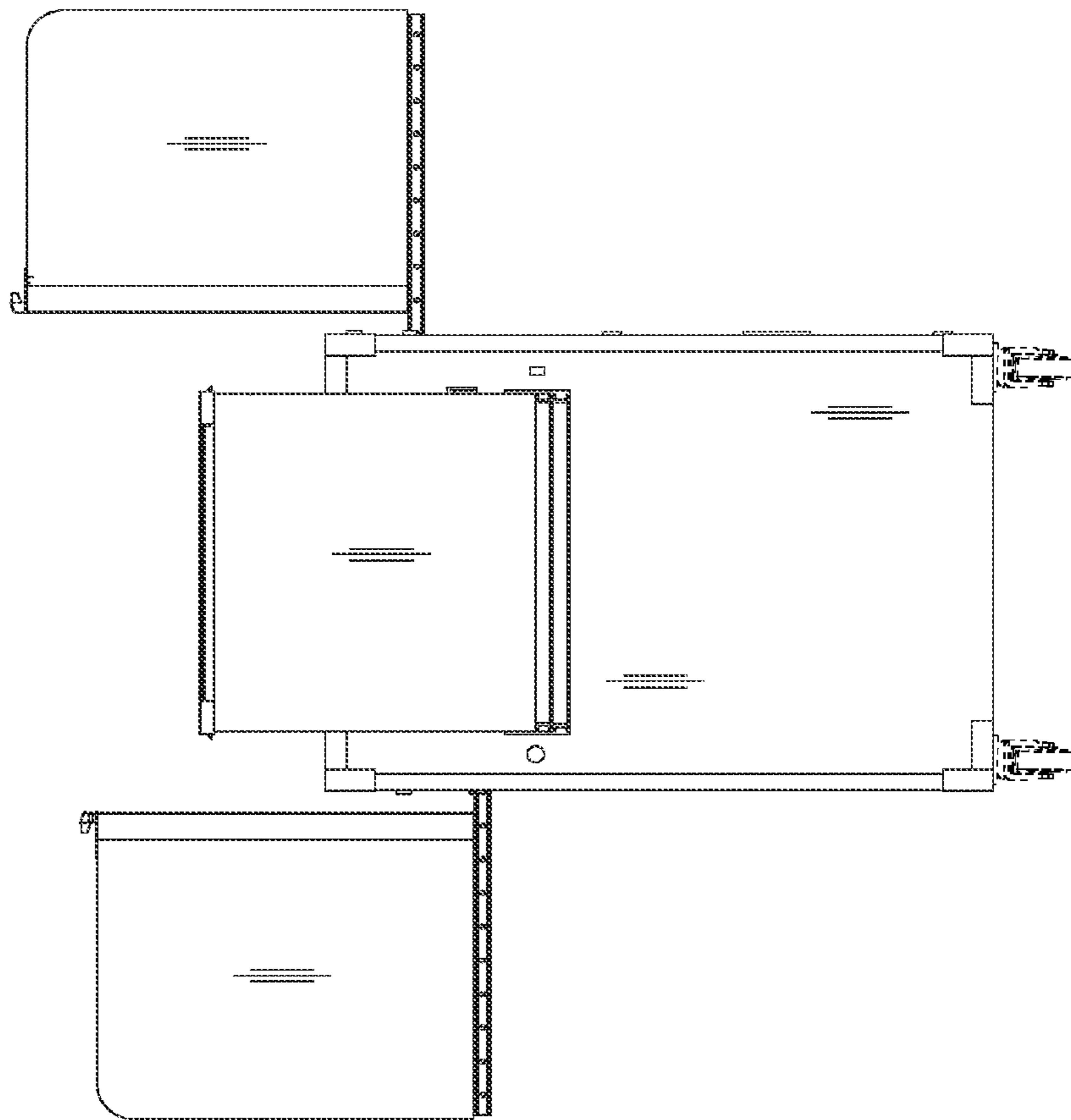

FIG. 5

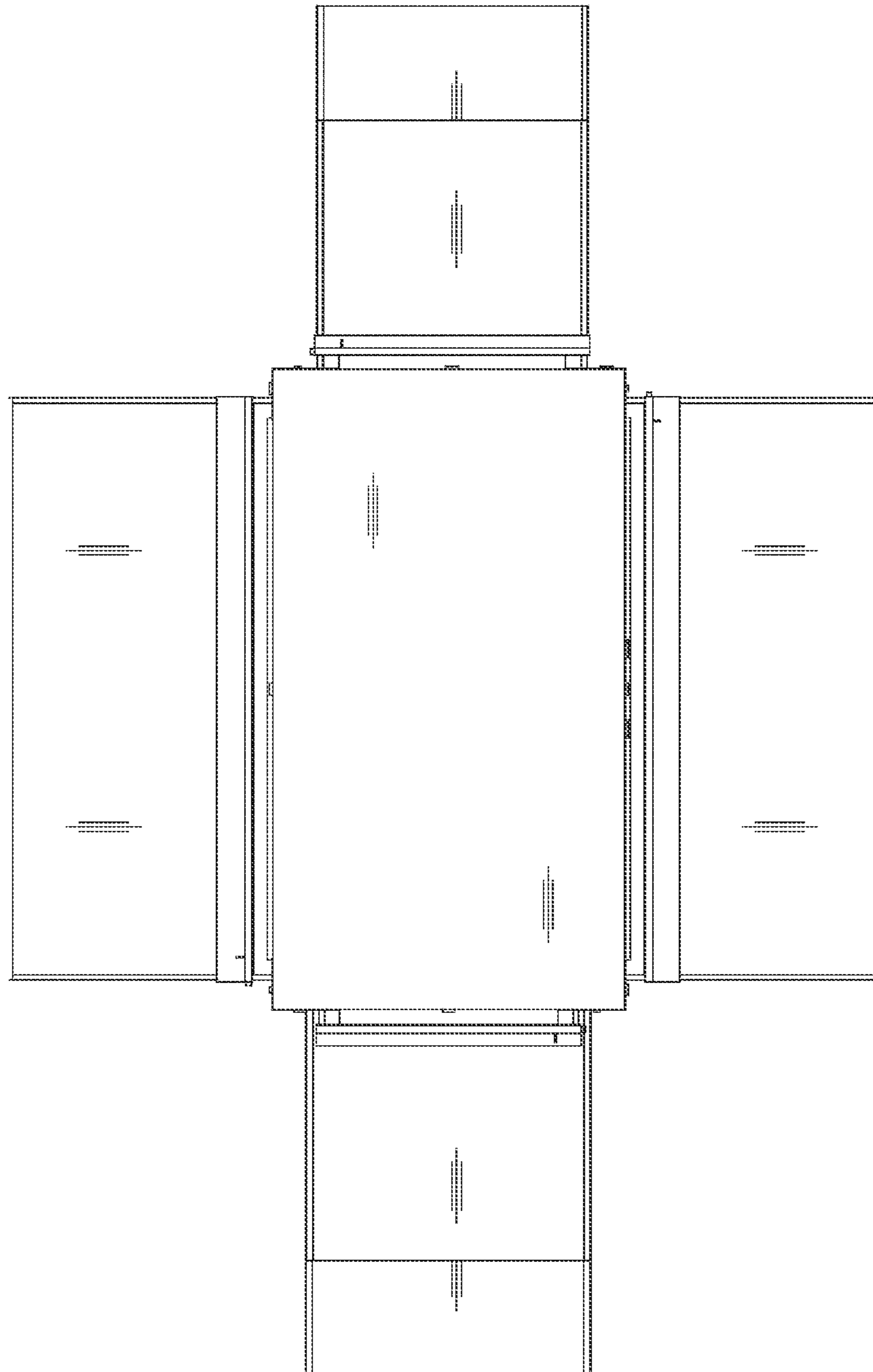

FIG. 6

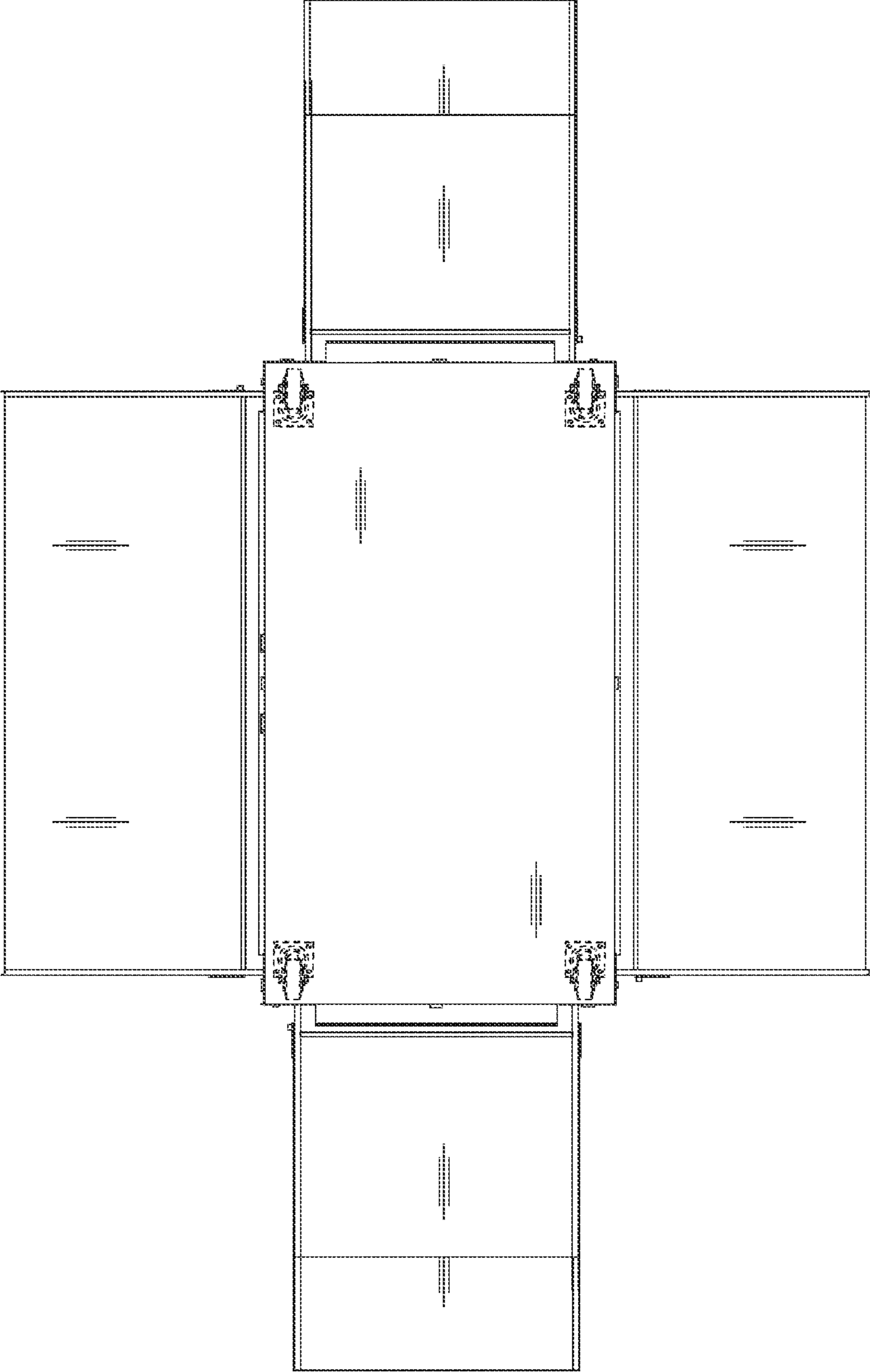

FIG. 7

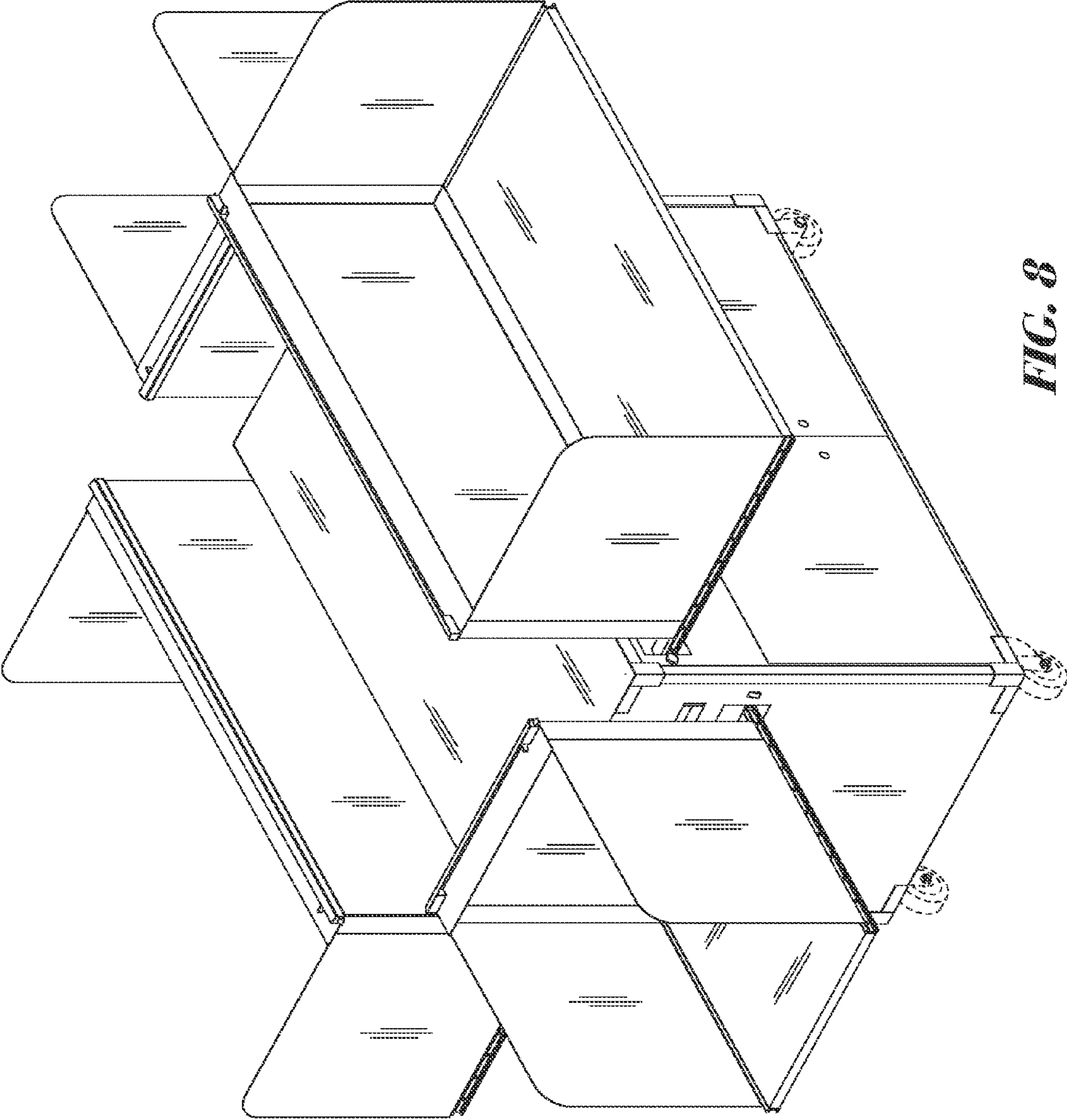

FIG. 8

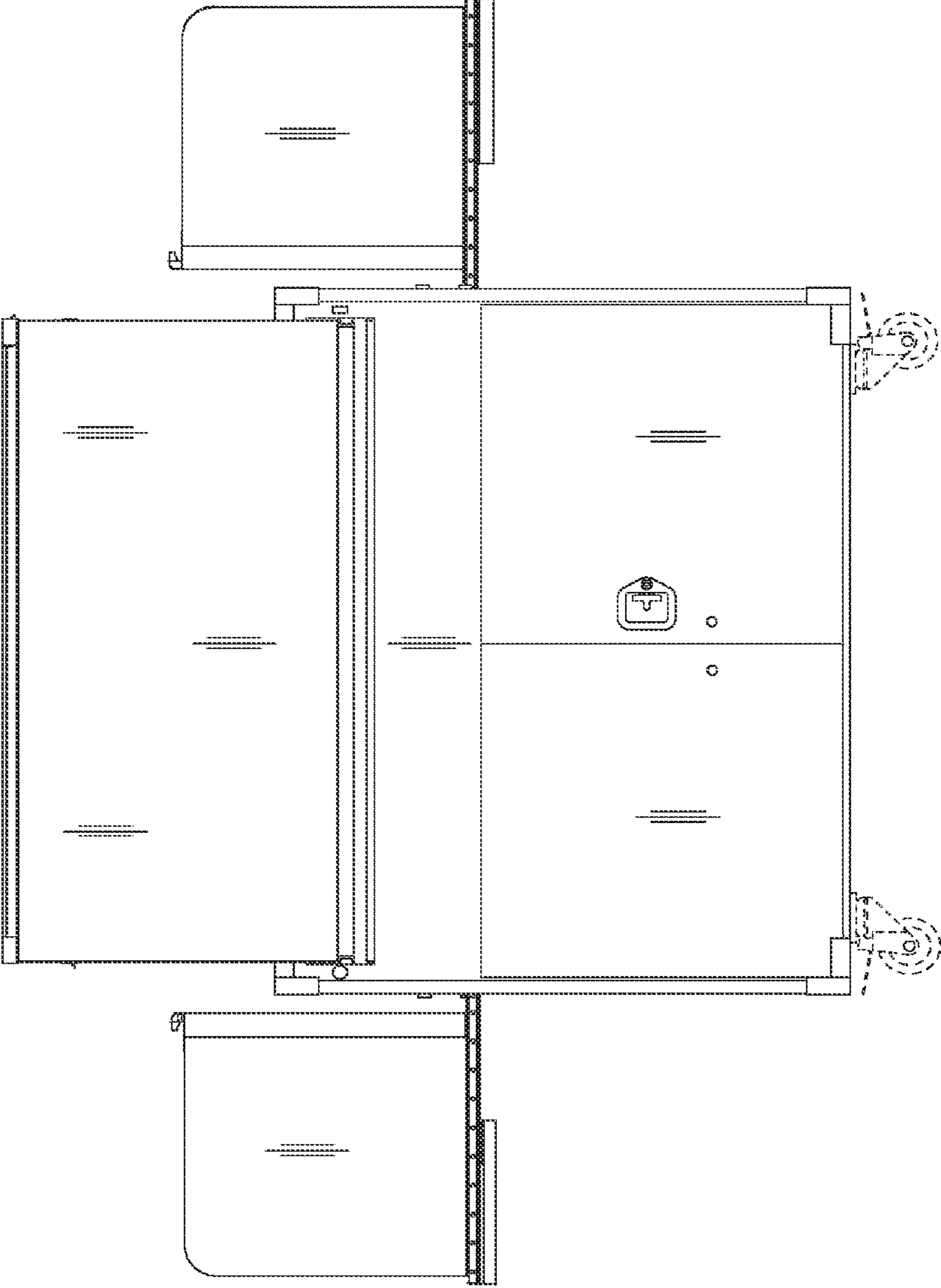

FIG. 9

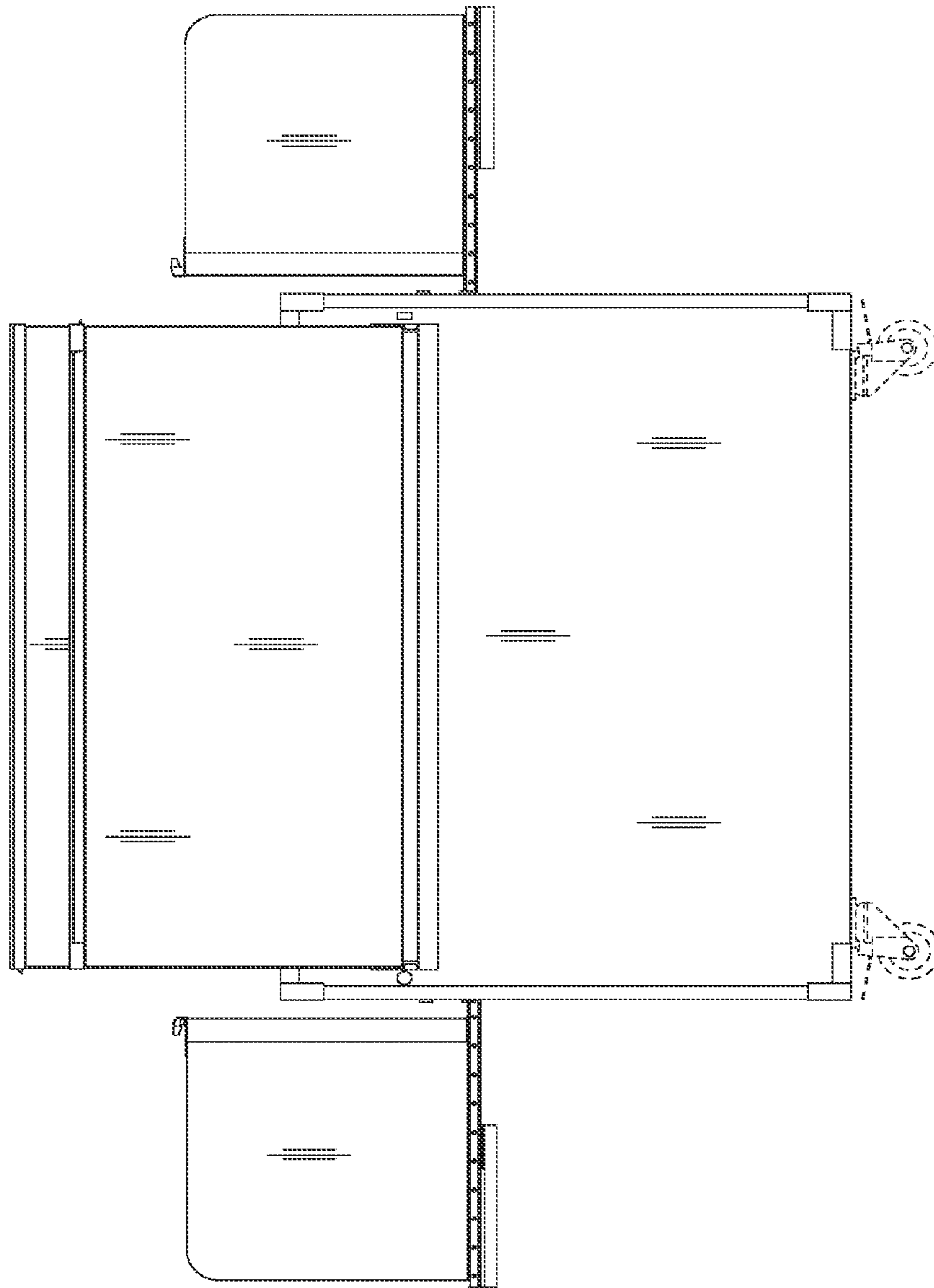

FIG. 10

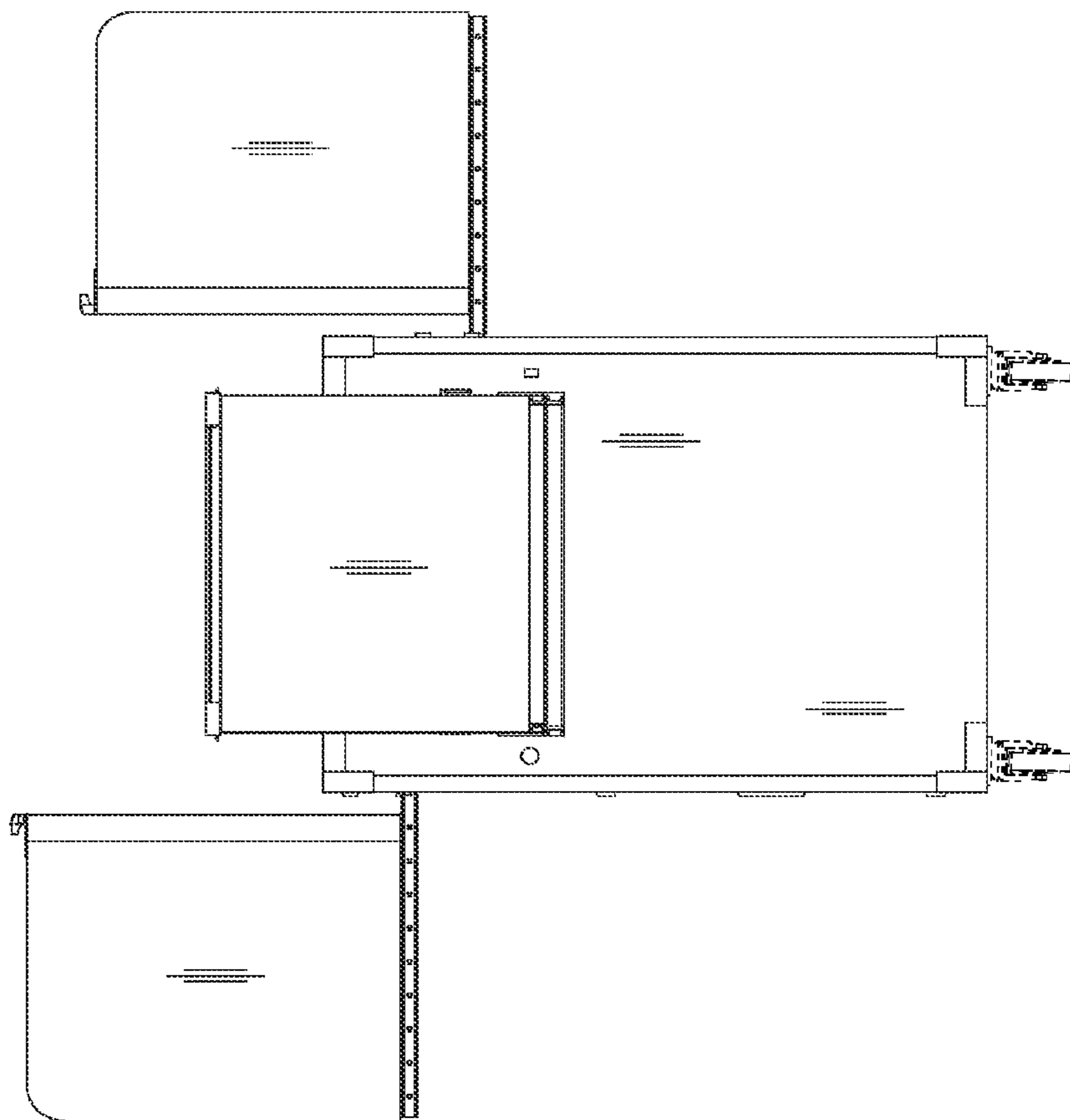

FIG. 11

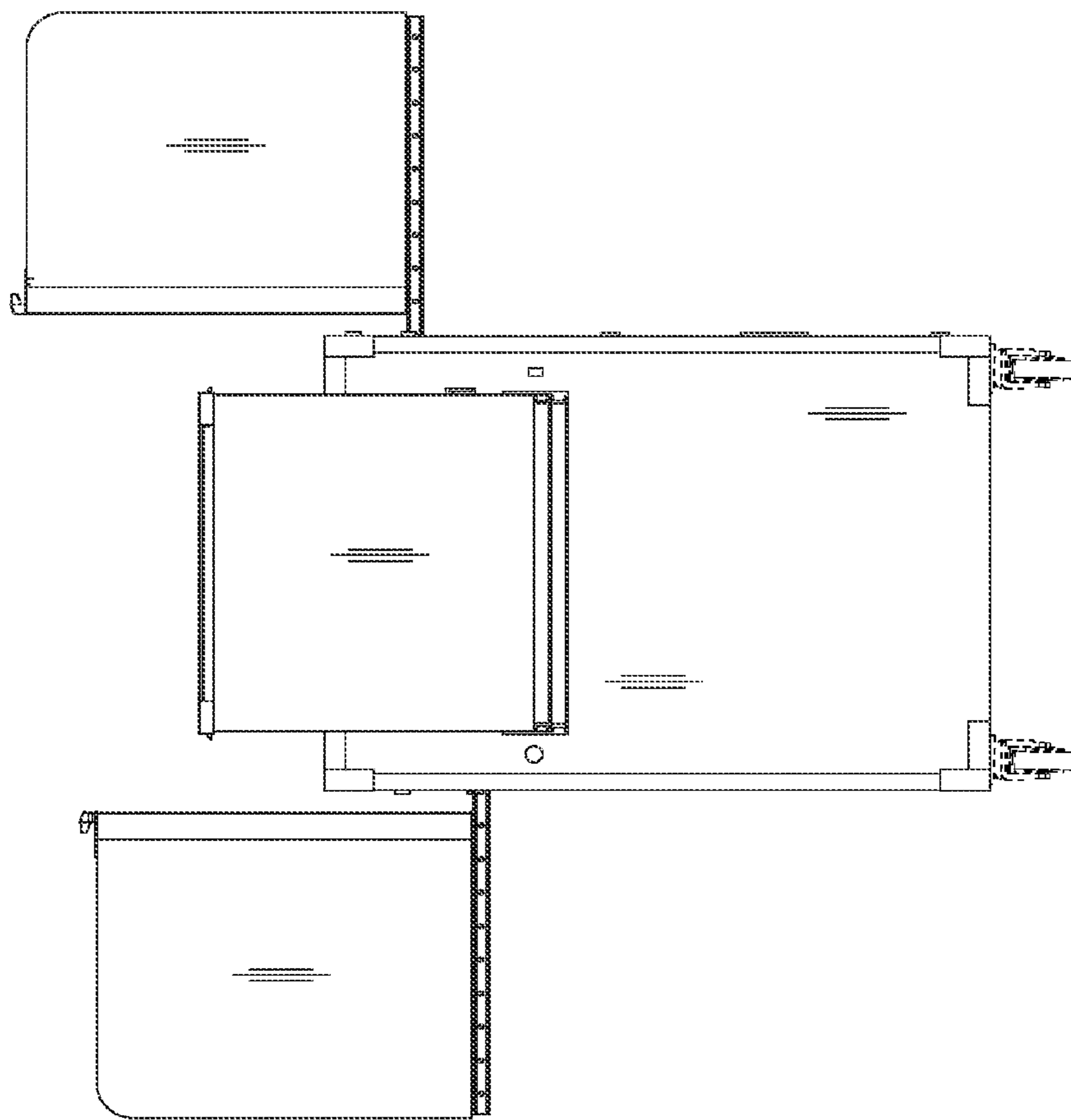

FIG. 12

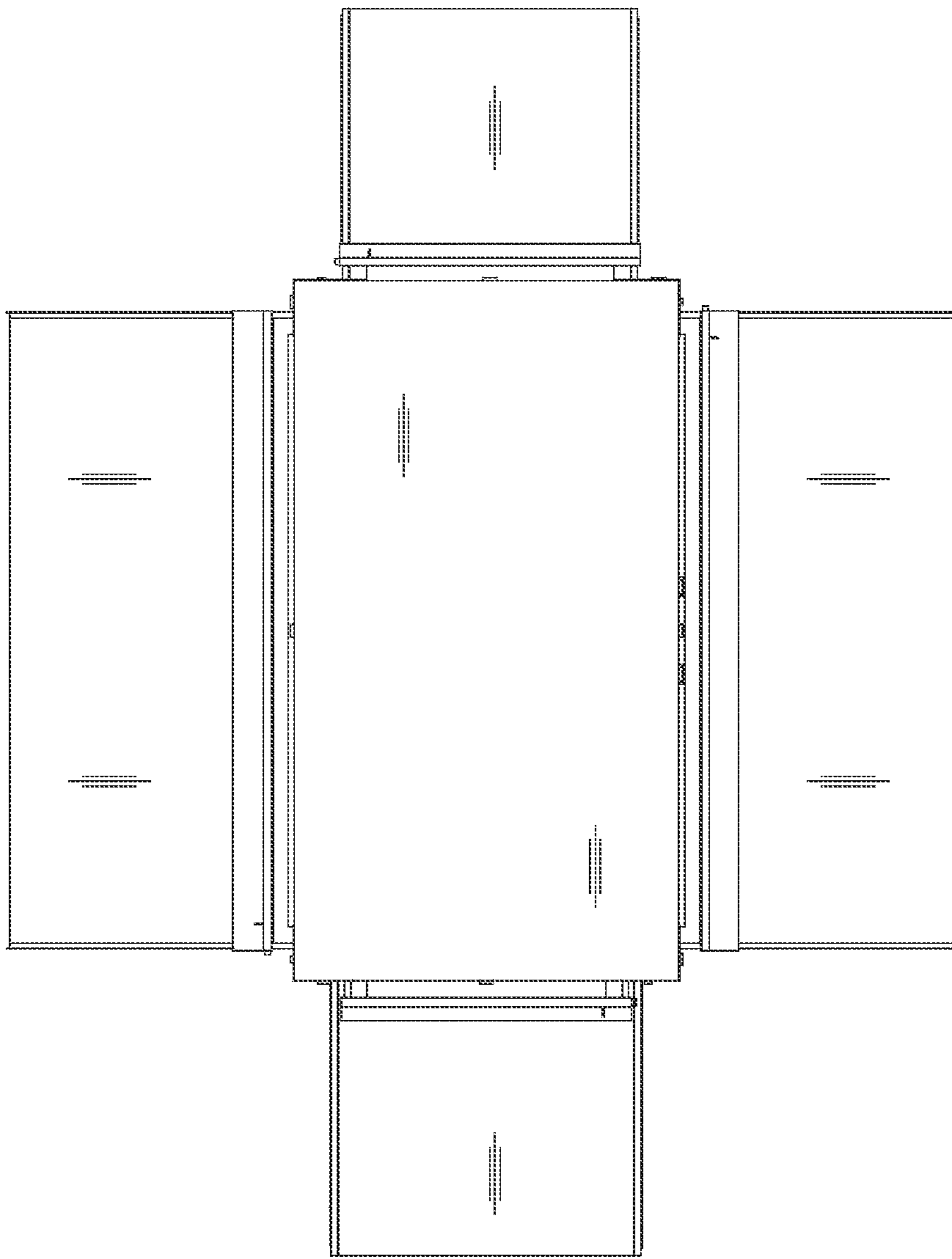

FIG. 13

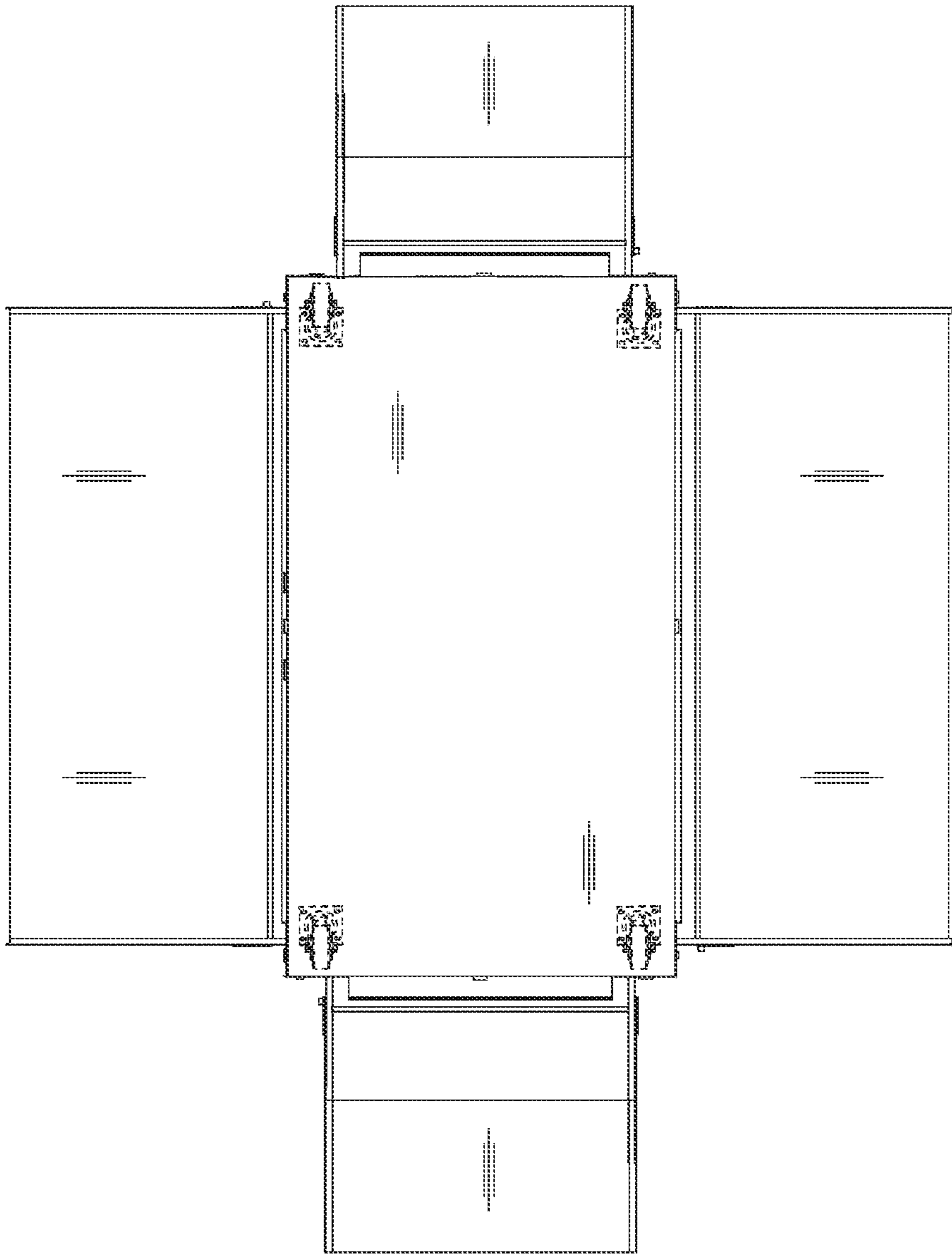

FIG. 14

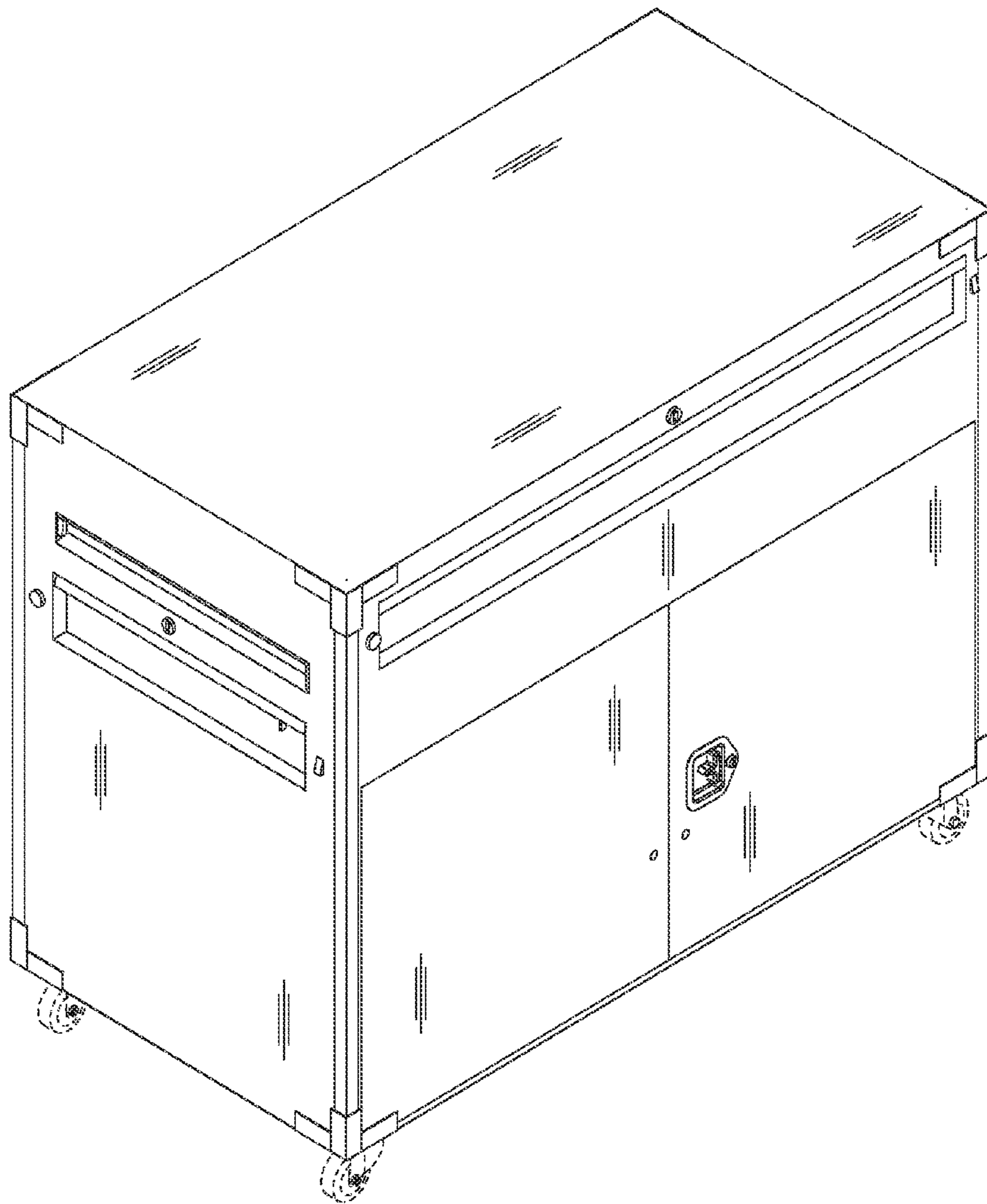

FIG. 15

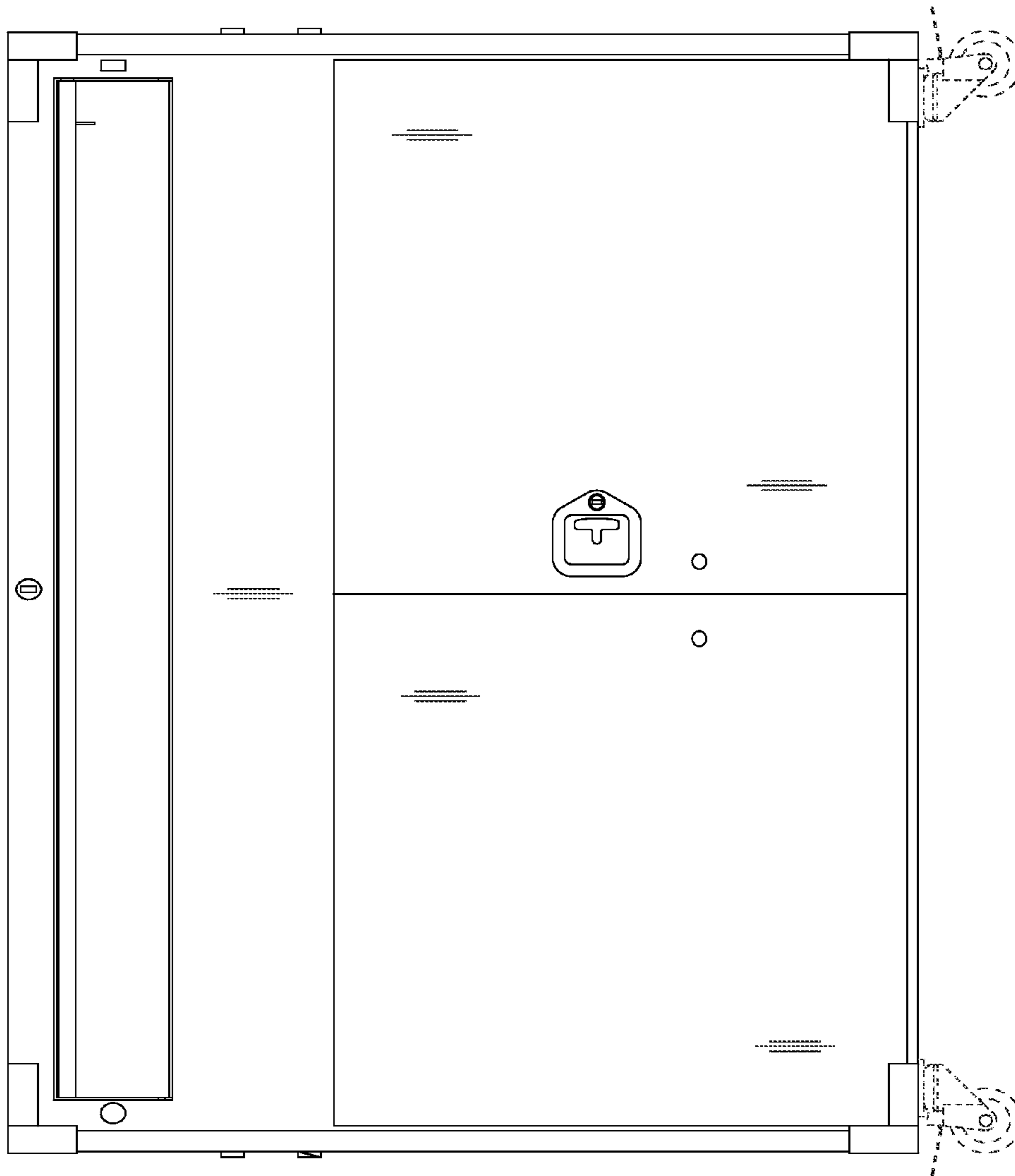

FIG. 16

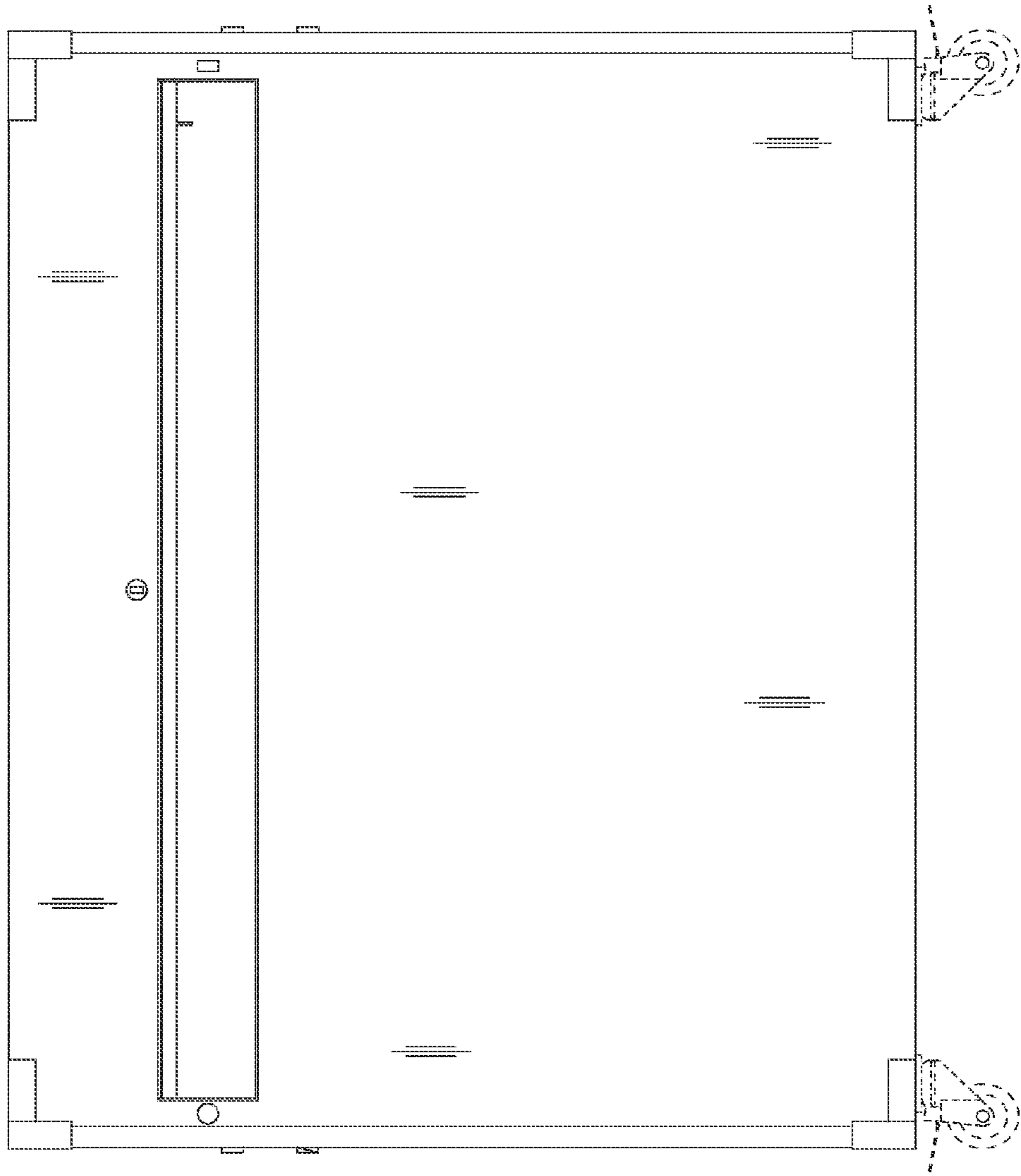

FIG. 17

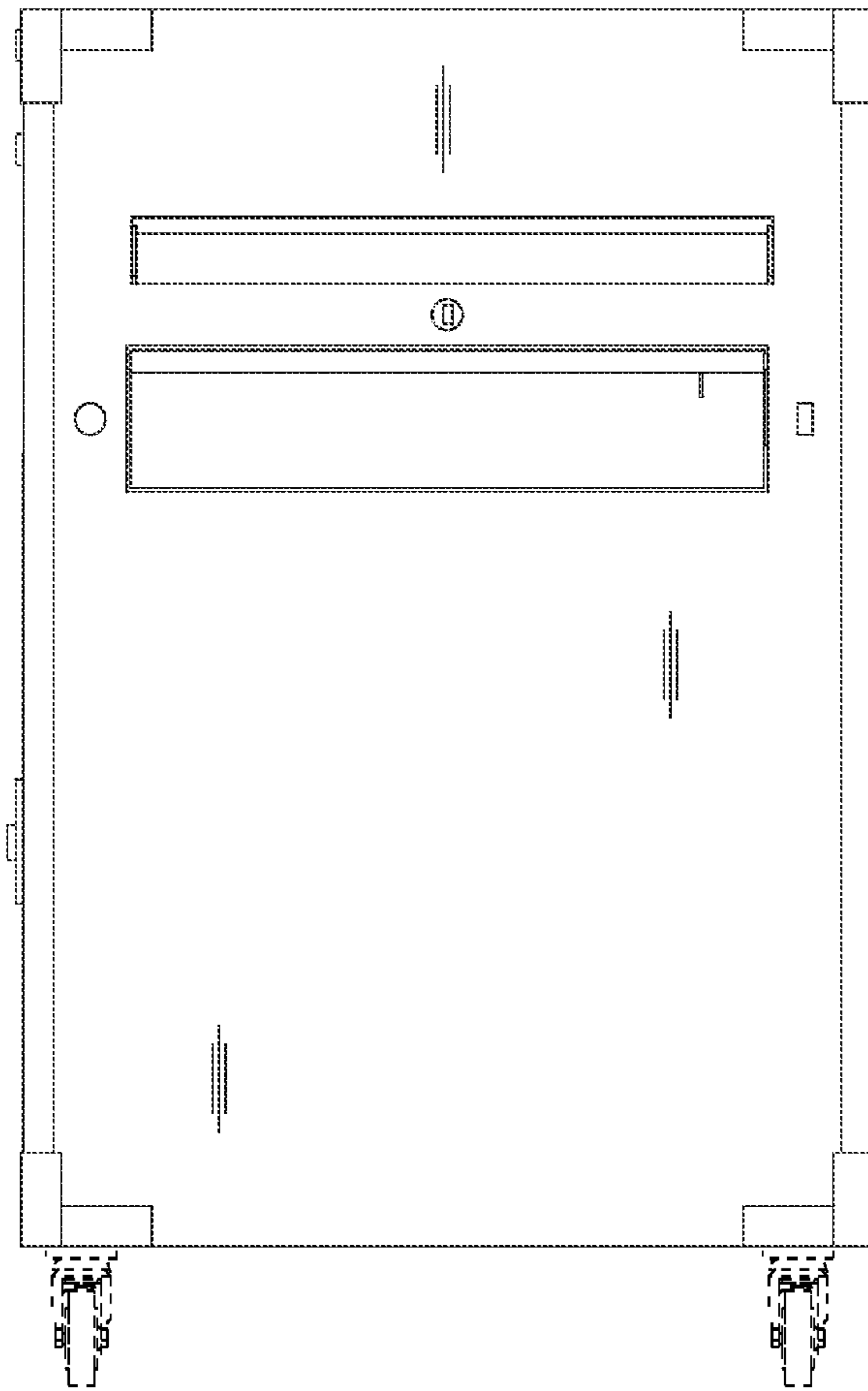

FIG. 18

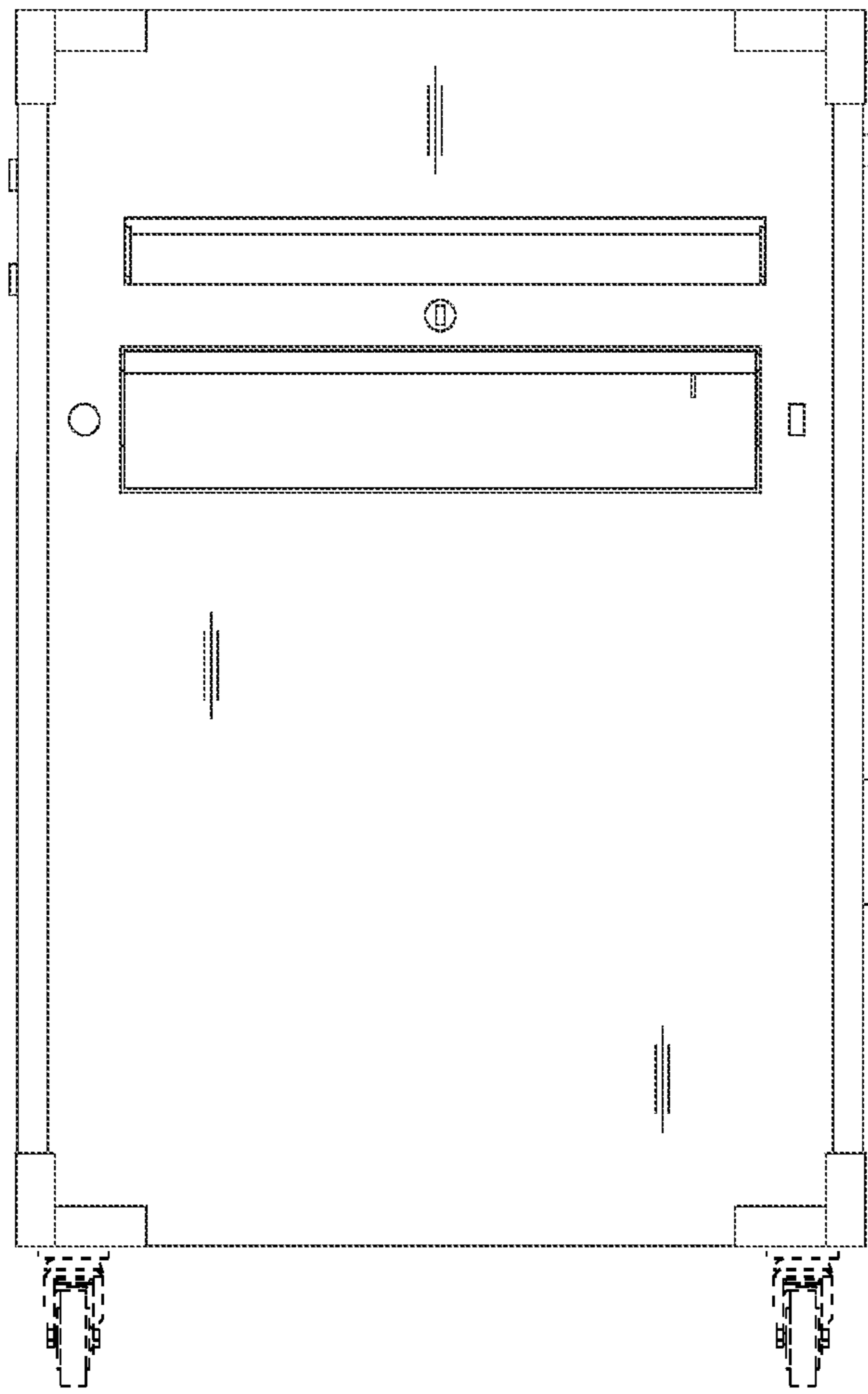

FIG. 19

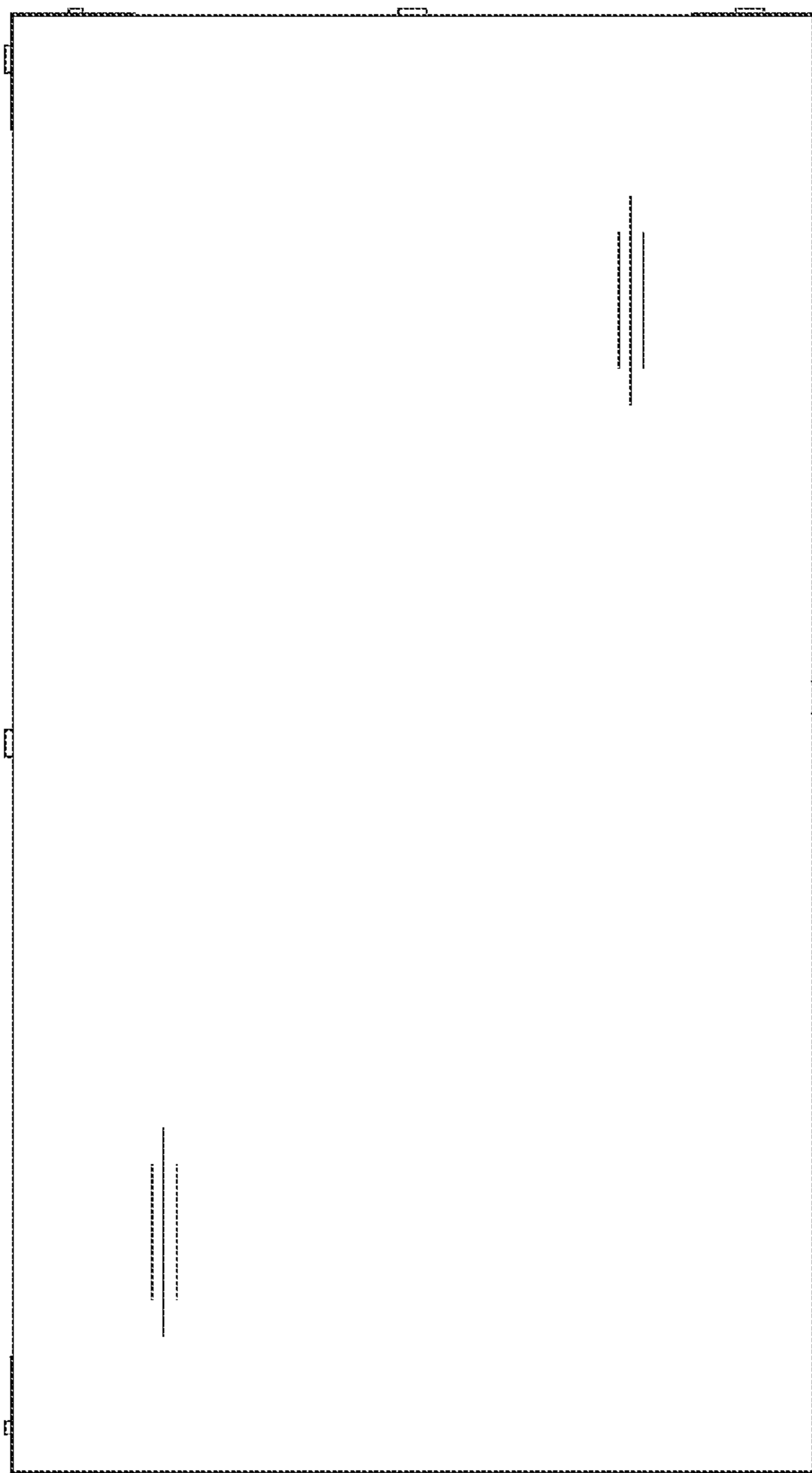

FIG. 20

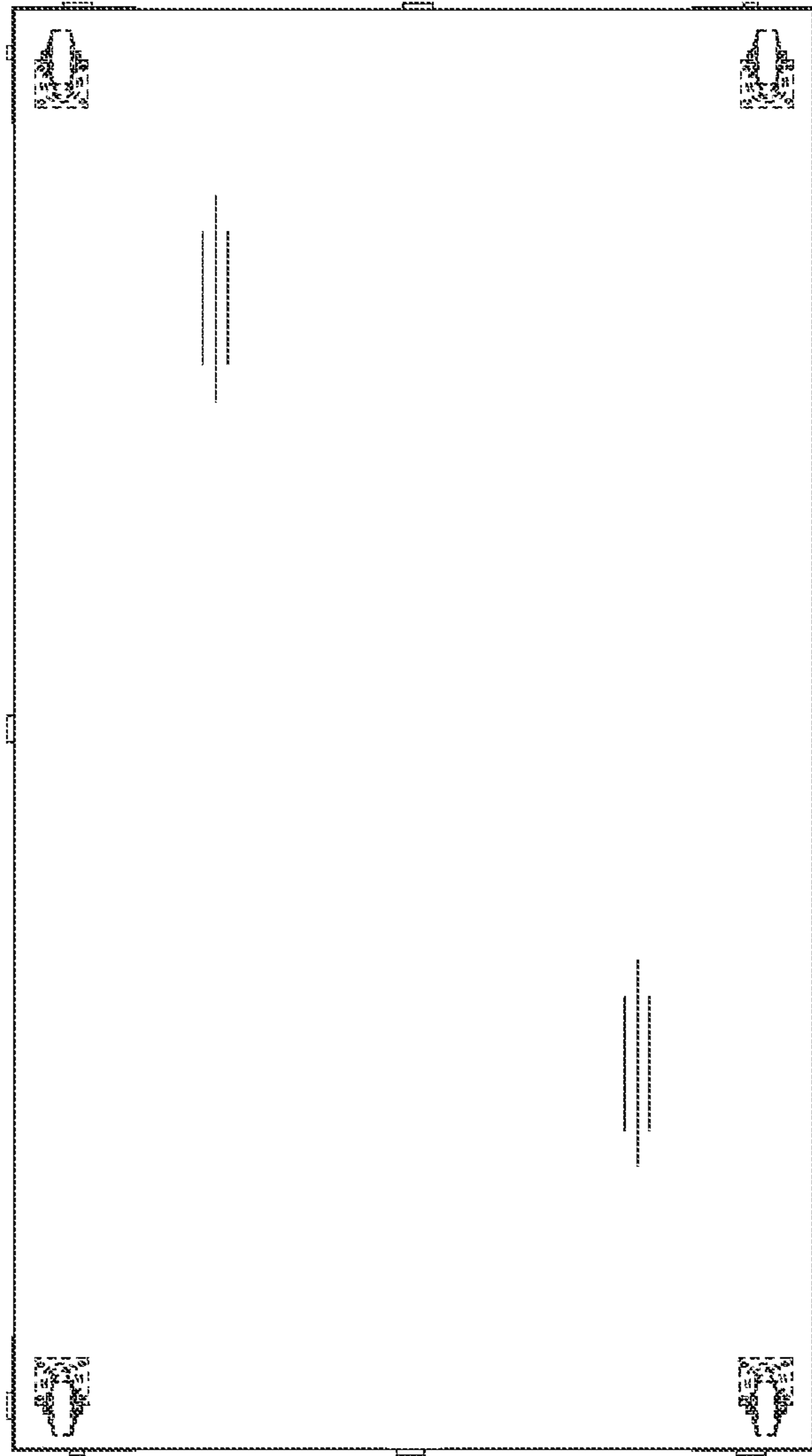

FIG. 21