



US00D673385S

(12) **United States Design Patent**
Lu

(10) **Patent No.:** **US D673,385 S**
(45) **Date of Patent:** **** Jan. 1, 2013**

(54) **CHAIR**

(75) Inventor: **Wu-Chin Lu, Chia Yi Hsien (TW)**

(73) Assignee: **Chuang Shine Co., Ltd., Chia Yi Hsien (TW)**

(**) Term: **14 Years**

(21) Appl. No.: **29/402,106**

(22) Filed: **Sep. 21, 2011**

(51) **LOC (9) Cl.** **06-01**

(52) **U.S. Cl.** **D6/366**

(58) **Field of Classification Search** D6/334-336,
D6/364, 365, 366, 367, 369, 370, 379, 380,
D6/498, 500-502; 297/284.4, 452.15, 452.21,
297/452.29, 452.3, 452.46, 452.48

See application file for complete search history.

(56) **References Cited**

U.S. PATENT DOCUMENTS

D576,814 S * 9/2008 Baldanzi et al. D6/366
D653,045 S * 1/2012 Schaack D6/366

D654,291 S * 2/2012 Pearson et al. D6/500
D660,056 S * 5/2012 Diffrient D6/500
8,191,970 B2 * 6/2012 Igarashi et al. 297/452.15

* cited by examiner

Primary Examiner — Mimoso De

(74) *Attorney, Agent, or Firm* — Alan Kamrath; Kamrath IP Lawfirm, PA

(57) **CLAIM**

The ornamental design for a chair, as shown and described.

DESCRIPTION

FIG. 1 is a perspective view of a chair showing my design;
FIG. 2 is a front elevational view thereof;
FIG. 3 is a rear elevational view thereof;
FIG. 4 is a left side elevational view thereof;
FIG. 5 is a right side elevational view thereof;
FIG. 6 is a top plan view thereof; and,
FIG. 7 is a bottom plan view thereof.

1 Claim, 7 Drawing Sheets

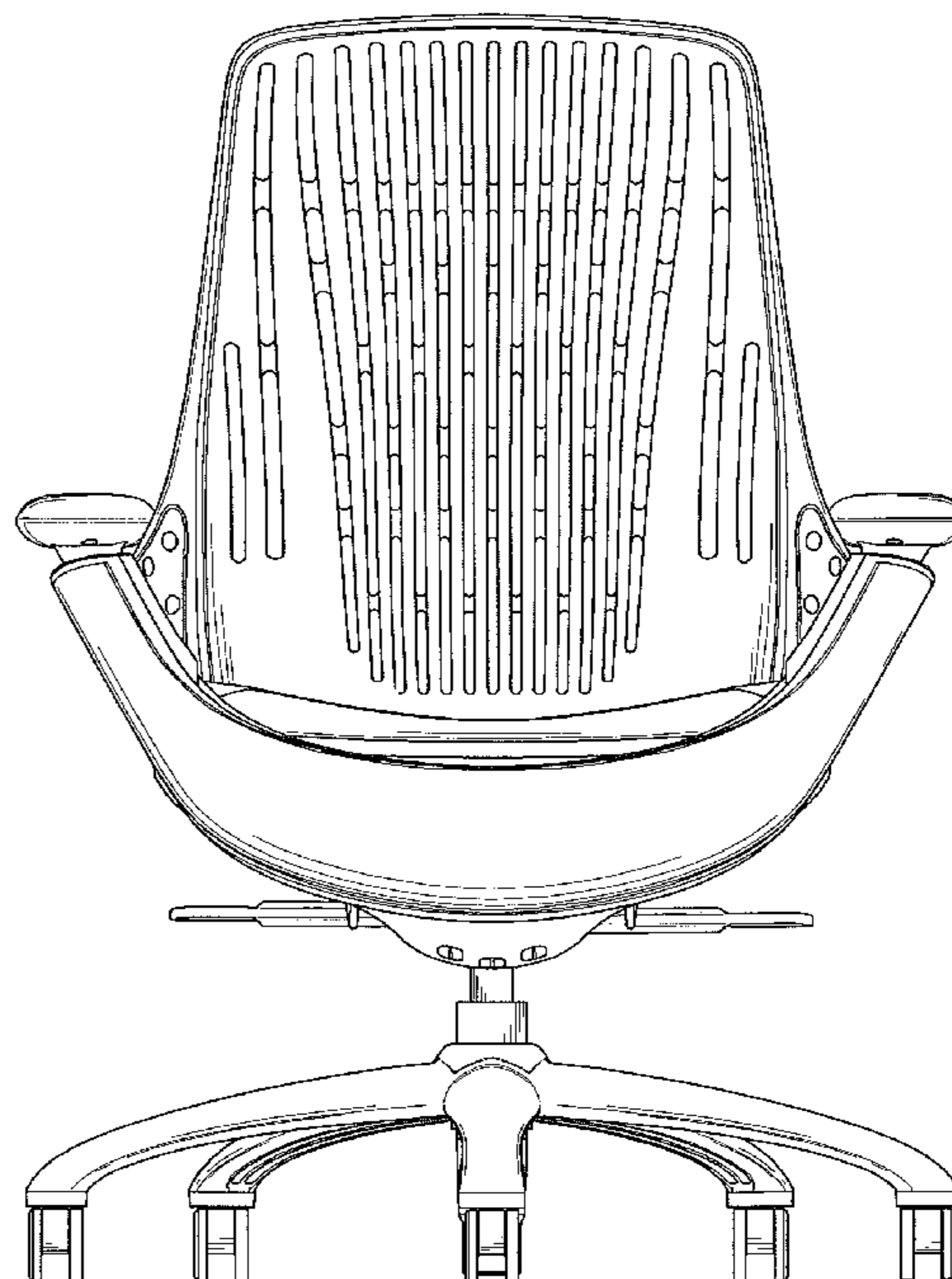
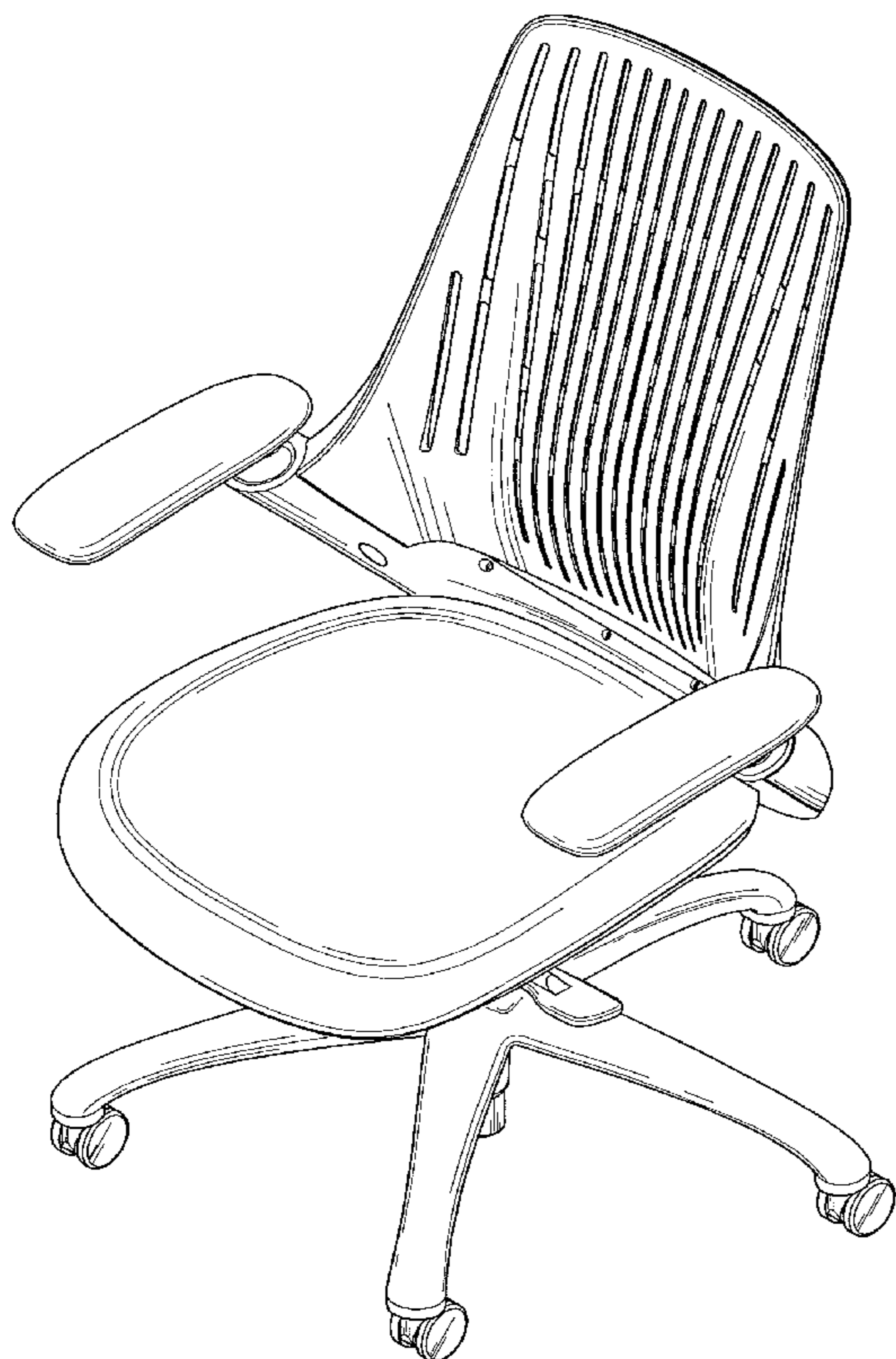



FIG.1

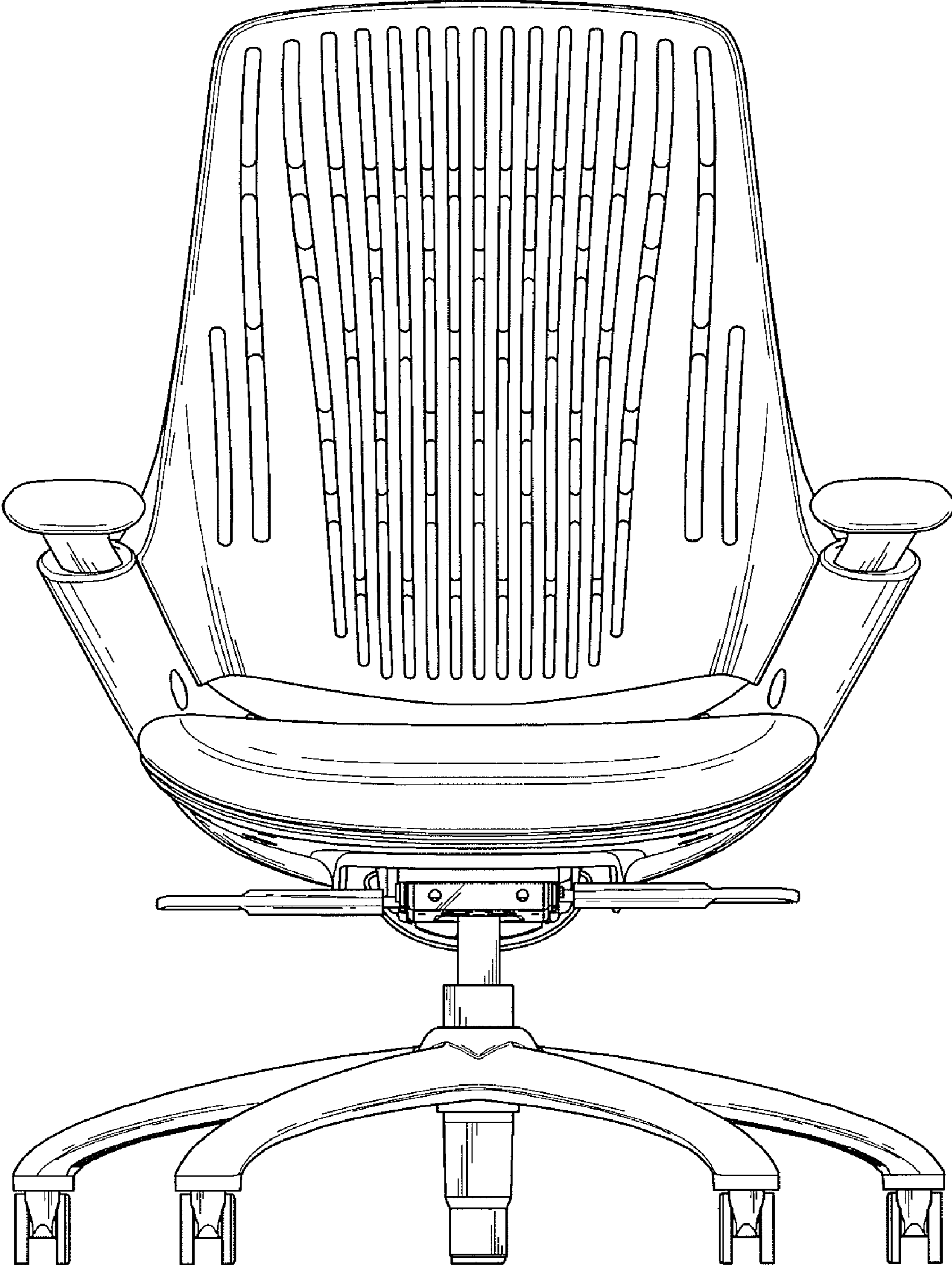

FIG. 2

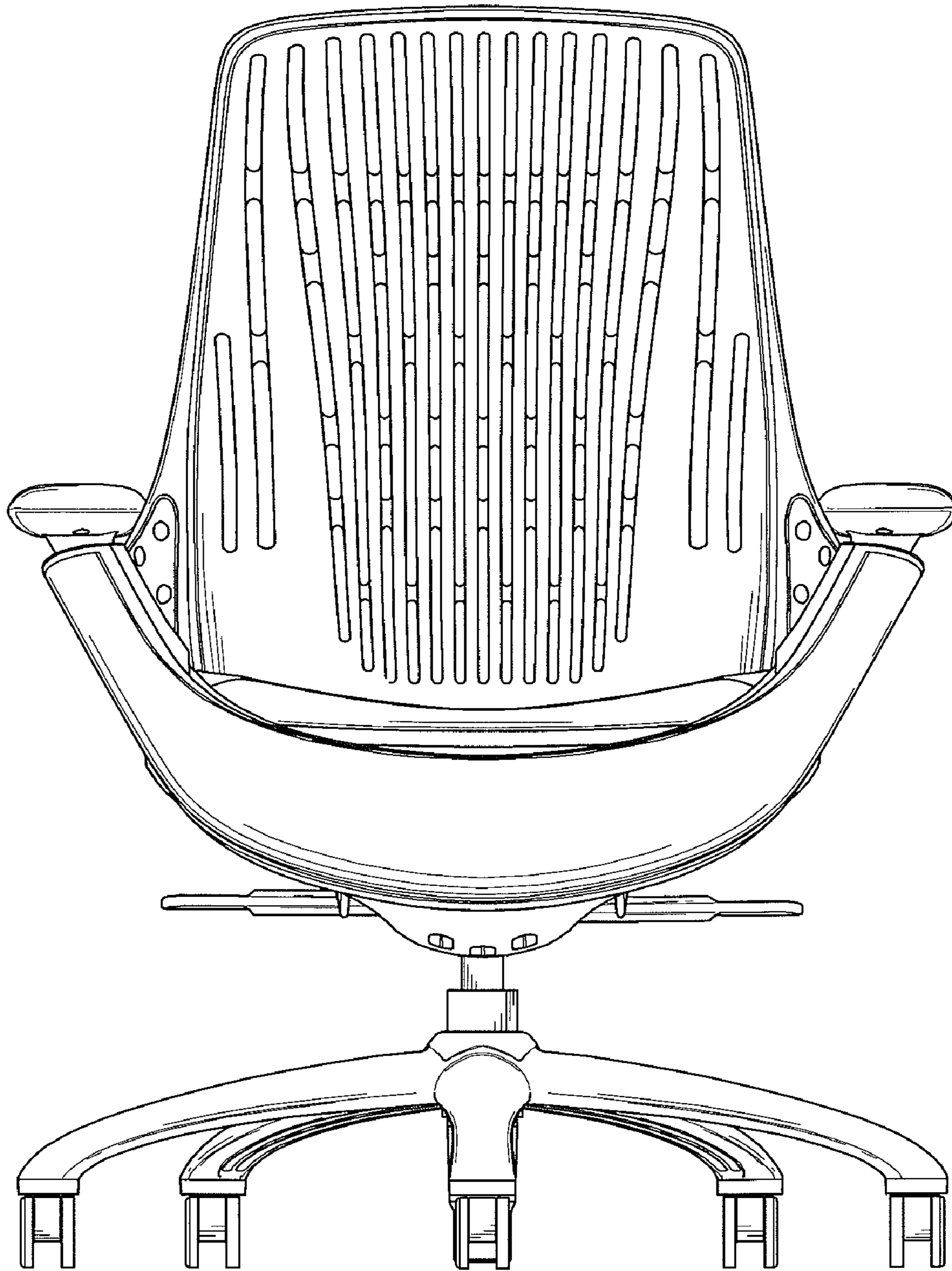

FIG.3

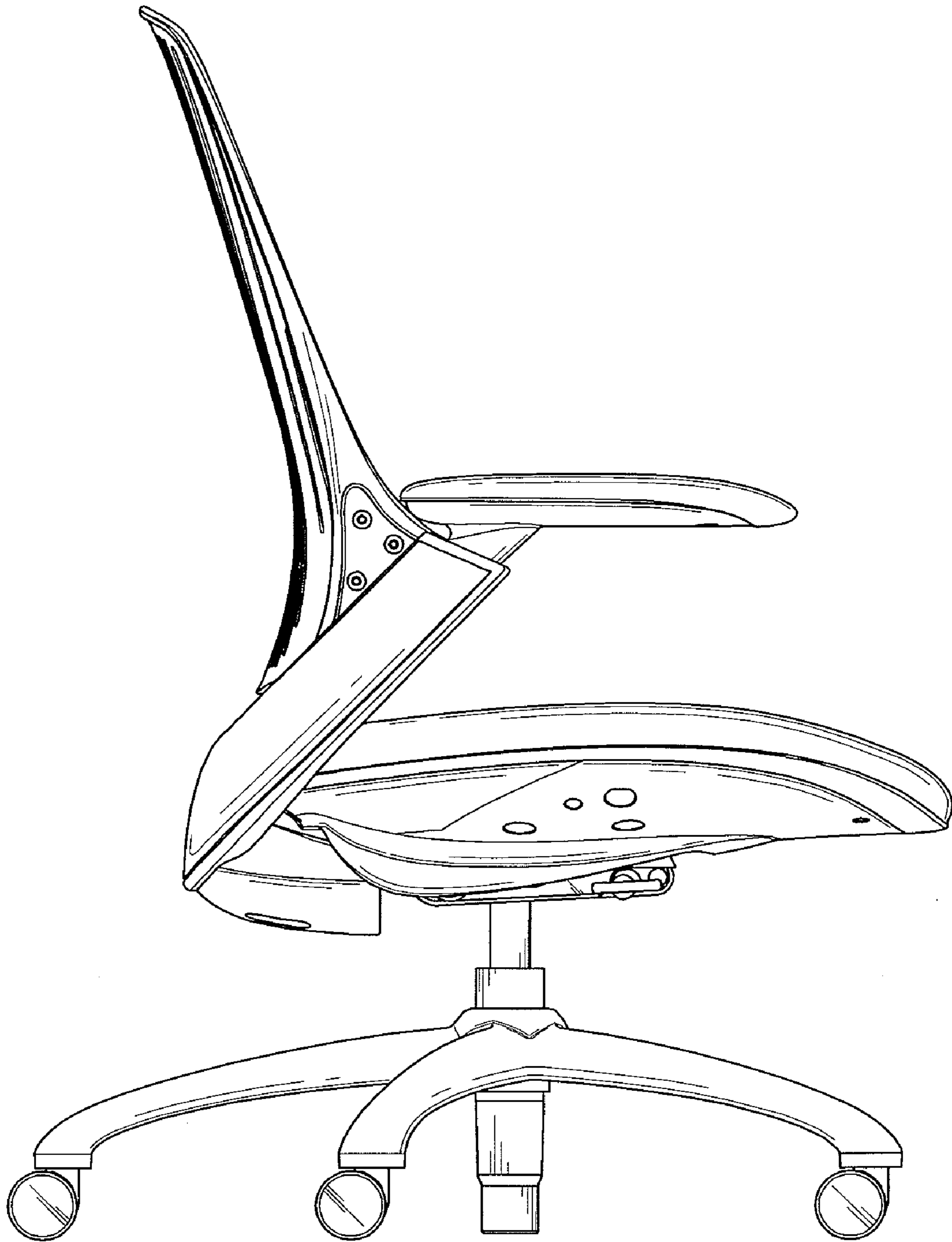

FIG.4

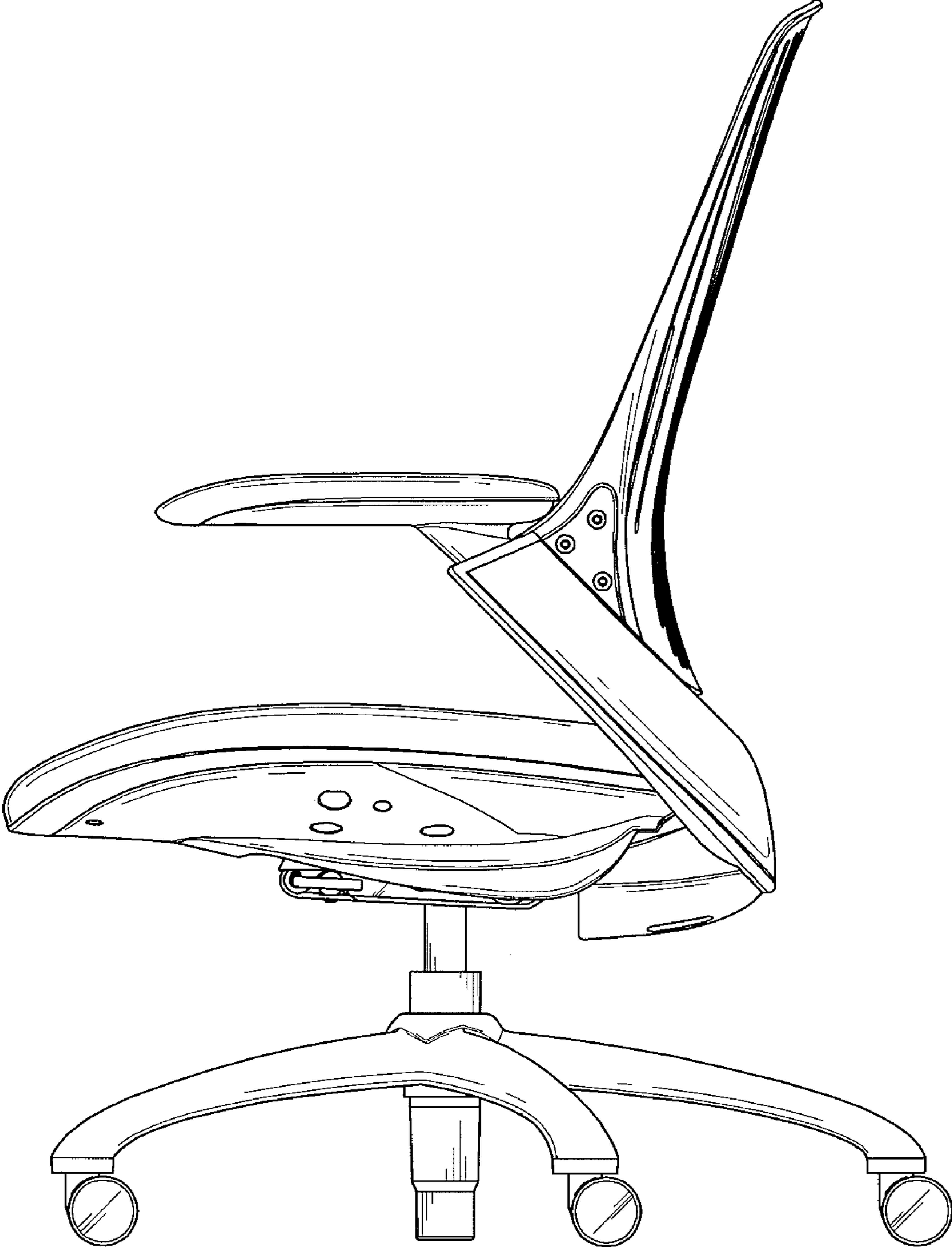

FIG.5

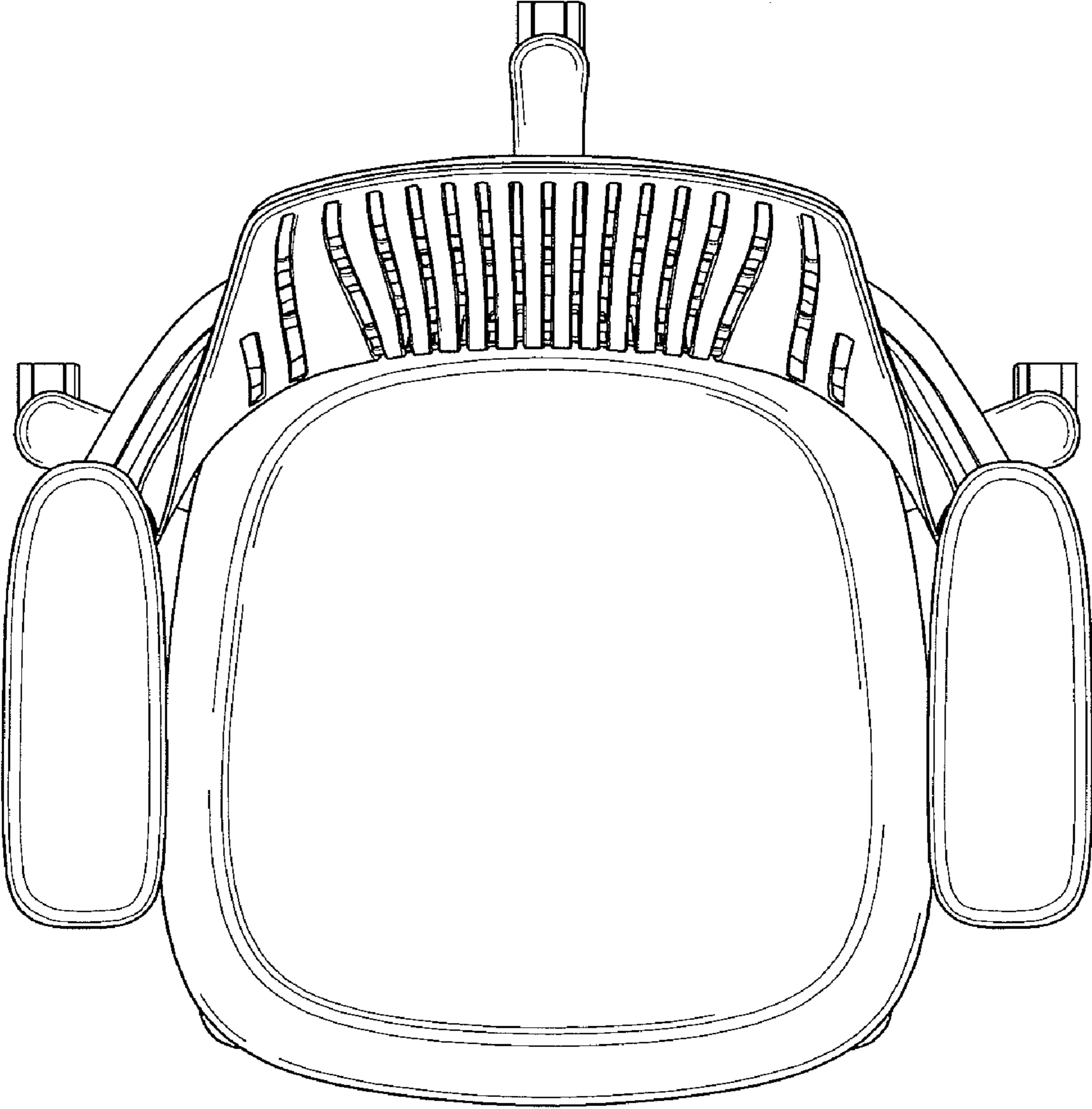

FIG. 6

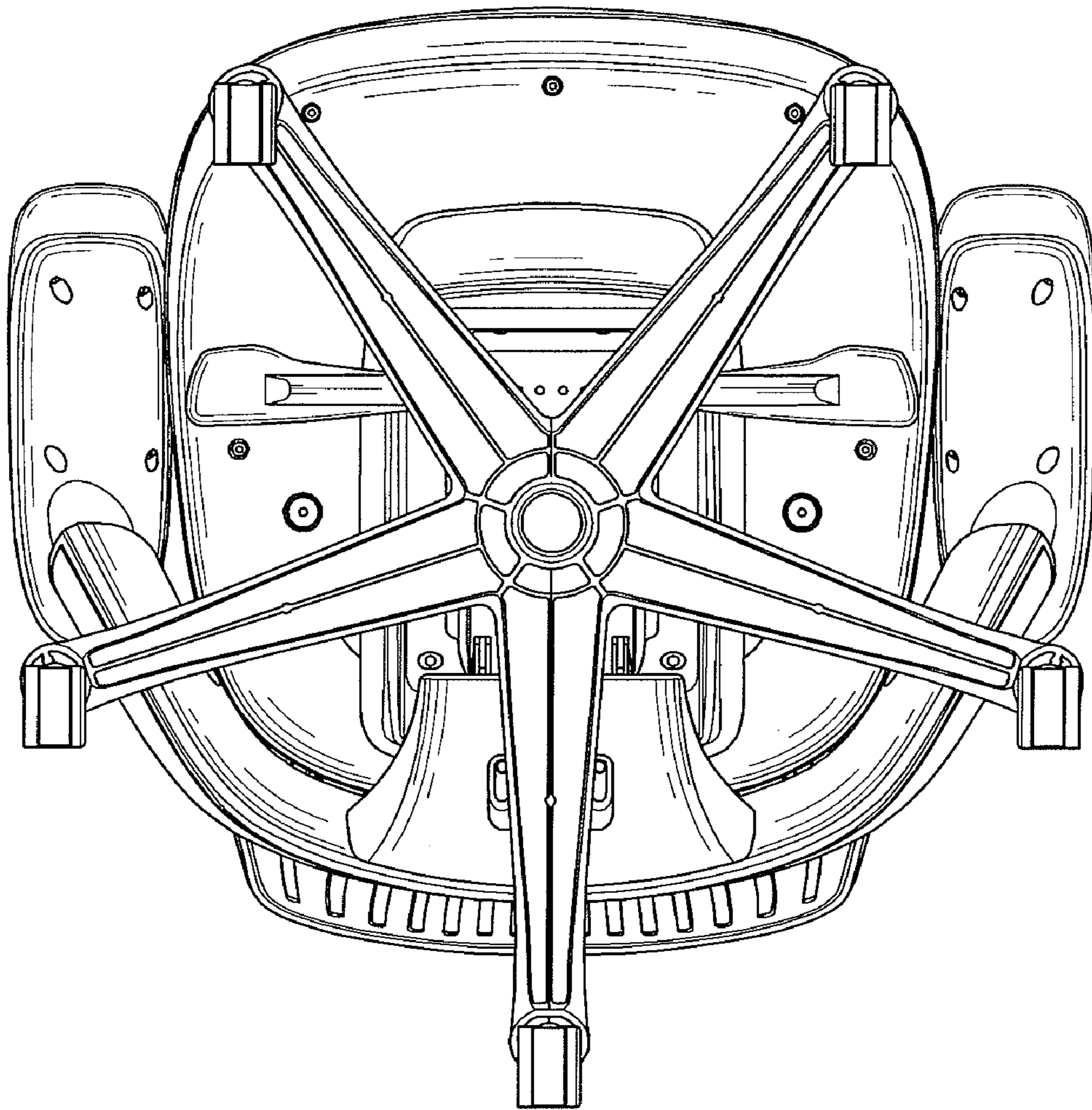

FIG.7