



US00D673328S

(12) **United States Design Patent**
Arinsmier et al.

(10) **Patent No.:** **US D673,328 S**
(45) **Date of Patent:** **** Dec. 25, 2012**

(54) **COSMETIC COLLECTION**

(75) Inventors: **Keri Marsh Arinsmier**, Cincinnati, OH (US); **Carolina Lavin**, Jersey City, NJ (US)

(73) Assignee: **The Procter & Gamble Company**, Cincinnati, OH (US)

(**) Term: **14 Years**

(21) Appl. No.: **29/366,312**

(22) Filed: **Jul. 22, 2010**

(51) **LOC (9) Cl.** **28-03**

(52) **U.S. Cl.** **D28/76**

(58) **Field of Classification Search** 401/129, 401/121; 222/183; 30/42, 50, 526, 206; D16/135; 359/802, 805; D9/415, 416, 417, D9/718, 719, 720, 721, 697, 696, 695, 699, D9/454, 692, 693, 694, 698, 521, 516, 529, D9/504, 502, 503, 505, 519, 520, 418, 447, D9/722; D28/76, 56, 60, 82, 4, 7, 8, 10, D28/9, 6, 13, 44, 45, 46, 47, 48, 49, 50, 53, D28/54.1, 57, 99, 83, 77, 89, 90, 51, 52, 54, D28/55; 206/581; 132/295, 318, 296, 297, 132/200, 73, 285

See application file for complete search history.

(56) **References Cited**

U.S. PATENT DOCUMENTS

1,608,449 A * 11/1926 Wendel 401/125
(Continued)

OTHER PUBLICATIONS

U.S. Appl. No. 29/366,274, filed Jul. 22, 2010, Keri Marsh Arinsmier.

(Continued)

Primary Examiner — Kevin Rudzinski

(74) *Attorney, Agent, or Firm* — John G. Powell; Megan C. Hymore

(57) **CLAIM**

The ornamental design for a cosmetic collection, as shown and described.

DESCRIPTION

FIG. 1 is a perspective front view of a first embodiment of a cosmetic collection, embodying the new design; FIG. 2 is a front view of the design shown in FIG. 1; FIG. 3 is a back view of the design shown in FIG. 1; FIG. 4 is a left side view of the design shown in FIG. 1; FIG. 5 is a right side view of the design shown in FIG. 1; FIG. 6 is a bottom view of the design shown in FIG. 1; and FIG. 7 is a top view of the design shown in FIG. 1. FIG. 8 is a perspective front view of a second embodiment of a cosmetic collection, embodying the new design; FIG. 9 is a front view of the design shown in FIG. 8; FIG. 10 is a back view of the design shown in FIG. 8; FIG. 11 is a left side view of the design shown in FIG. 8; FIG. 12 is a right side view of the design shown in FIG. 8; FIG. 13 is a bottom view of the design shown in FIG. 8; and FIG. 14 is a top view of the design shown in FIG. 8. The diagonal line shading in these figures represents the color green. The broken lines shown in the figures illustrate environmental features and form no part of the claimed design.

1 Claim, 8 Drawing Sheets

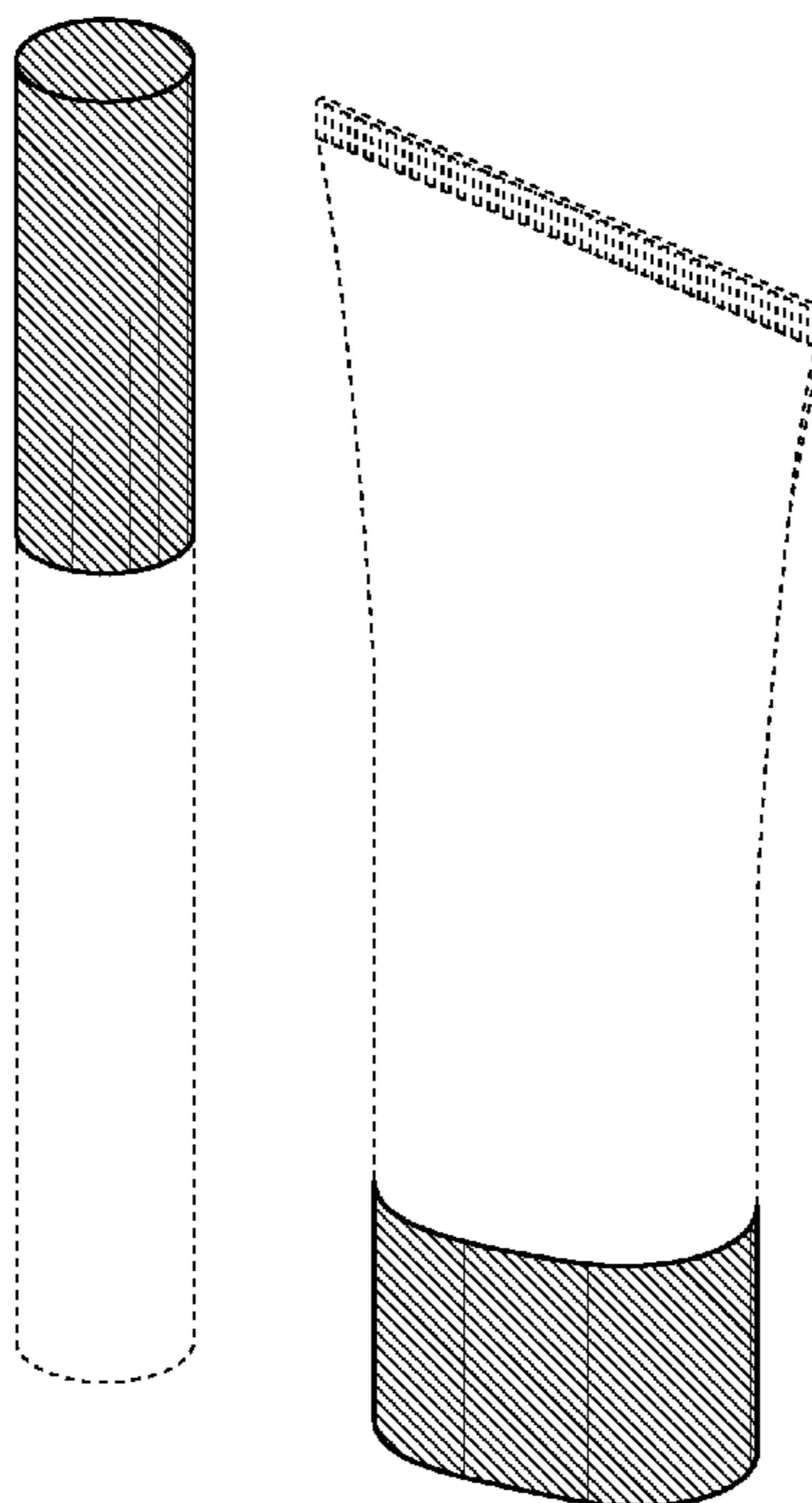

U.S. PATENT DOCUMENTS

1,766,990	A *	6/1930	Freeman	132/318	D633,653	S *	3/2011	Lee	D28/76
D117,276	S *	10/1939	Jung	D28/89	D636,940	S *	4/2011	Acierto et al.	D28/76
D175,548	S *	9/1955	Kane	D4/114	D642,333	S *	7/2011	Praster	D28/82
D188,397	S *	7/1960	Hulsh	D4/114	D643,307	S *	8/2011	Arinsmier et al.	D9/722
3,235,128	A *	2/1966	Hansen	222/107	D645,749	S *	9/2011	Lee	D9/504
3,529,899	A *	9/1970	Gruska	401/121	8,021,065	B2 *	9/2011	Lou	401/129
D226,260	S *	2/1973	Hanamura	D9/697	D649,065	S *	11/2011	Arinsmier et al.	D9/697
D262,094	S *	12/1981	Tiboldo	D9/658	D649,066	S *	11/2011	Arinsmier et al.	D9/697
D316,221	S	4/1991	Dombroski		2002/0185148	A1 *	12/2002	Bengis	132/297
D319,178	S *	8/1991	Katada et al.	D9/617	2003/0000544	A1 *	1/2003	Byun	132/320
5,061,103	A *	10/1991	Walsh-Smith	401/122	2005/0087207	A1 *	4/2005	Rousselet	132/318
5,086,793	A *	2/1992	Kingsford	132/218	2008/0295857	A1 *	12/2008	Gatesoupe	132/295
5,246,133	A *	9/1993	James	220/377					
D349,449	S *	8/1994	Linner	D9/699					
D351,101	S *	10/1994	Linner	D9/699					
D352,133	S *	11/1994	Wacker	D28/88					
D353,539	S *	12/1994	Linner	D9/447					
5,373,940	A *	12/1994	Hillelson	206/385					
D364,003	S *	11/1995	Benson	D28/7					
D364,006	S *	11/1995	Kamen	D28/88					
5,526,960	A *	6/1996	Breidenbach et al.	222/183					
D373,219	S *	8/1996	Gavin	D28/76					
5,582,328	A	12/1996	Brown						
5,586,694	A *	12/1996	Breidenbach et al.	222/183					
D385,793	S *	11/1997	Marsal	D9/503					
D388,549	S *	12/1997	Mouyiaris et al.	D28/82					
D397,608	S *	9/1998	Fiore	D9/697					
D401,138	S *	11/1998	Rosen et al.	D9/697					
5,829,901	A *	11/1998	Brown et al.	401/87					
5,836,319	A *	11/1998	Lombardi	132/287					
D402,549	S *	12/1998	Nahum Albright	D9/545					
D408,591	S *	4/1999	Litton et al.	D28/82					
D412,661	S *	8/1999	Lavigne	D9/690					
5,941,254	A *	8/1999	Heler	132/297					
5,970,989	A *	10/1999	Litton	132/218					
D429,146	S *	8/2000	Thibiant et al.	D9/697					
D438,469	S *	3/2001	Breidenbach et al.	D9/504					
6,309,125	B1 *	10/2001	Peters	401/127					
D454,780	S *	3/2002	Leboeuf et al.	D9/697					
D458,143	S *	6/2002	Ackerman	D9/549					
D459,212	S *	6/2002	Gobe	D9/697					
D462,260	S *	9/2002	Joubert	D9/697					
6,450,179	B2 *	9/2002	Bengis	132/297					
D472,138	S *	3/2003	Brozell et al.	D9/697					
6,533,482	B1 *	3/2003	Byun	401/180					
D474,961	S *	5/2003	Haruta	D9/697					
D505,627	S *	5/2005	Py et al.	D9/697					
D507,078	S *	7/2005	Greenfield	D28/82					
D518,369	S *	4/2006	Haber et al.	D9/428					
D523,350	S *	6/2006	Ohmoto et al.	D9/690					
D525,130	S *	7/2006	Bloc	D9/503					
7,101,107	B1 *	9/2006	Byun	401/286					
D530,860	S *	10/2006	Funkhouser et al.	D28/82					
D540,987	S *	4/2007	Nobuto et al.	D28/89					
D542,978	S *	5/2007	Bortolotti	D28/76					
7,219,801	B2 *	5/2007	Christian	206/581					
D546,196	S *	7/2007	Py et al.	D9/695					
D547,672	S *	7/2007	Penfold et al.	D9/697					
D550,567	S *	9/2007	Soderstrom	D9/699					
D551,088	S *	9/2007	Dittmer et al.	D9/697					
D552,485	S *	10/2007	Grabiner et al.	D9/697					
D554,803	S *	11/2007	Parker	D28/76					
D557,613	S *	12/2007	Huang et al.	D9/697					
D559,703	S	1/2008	Egawa						
D570,708	S *	6/2008	Kerman	D9/697					
D572,604	S *	7/2008	Garofano et al.	D9/718					
D573,888	S *	7/2008	Pascalie	D9/504					
D580,597	S *	11/2008	Mascotte et al.	D28/76					
D581,597	S *	11/2008	Martinez	D28/82					
7,465,114	B2 *	12/2008	Kress et al.	401/129					
D584,608	S *	1/2009	McBride	D9/418					
D592,956	S *	5/2009	Thiellier	D9/504					
D601,898	S *	10/2009	Ikeda et al.	D9/503					
D601,900	S *	10/2009	Phemster	D9/521					
D604,050	S *	11/2009	Hale et al.	D4/116					
D611,823	S *	3/2010	Sindler	D9/529					
D617,050	S *	6/2010	Lou	D28/76					
D626,289	S *	10/2010	Lee	D28/82					

OTHER PUBLICATIONS

U.S. Appl. No. 29/366,278, filed Jul. 22, 2010, Keri Marsh Arinsmier.
U.S. Appl. No. 29/366,281, filed Jul. 22, 2010, Keri Marsh Arinsmier.
U.S. Appl. No. 29/366,285, filed Jul. 22, 2010, Keri Marsh Arinsmier.
U.S. Appl. No. 29/366,295, filed Jul. 22, 2010, Keri Marsh Arinsmier.
U.S. Appl. No. 29/366,297, filed Jul. 22, 2010, Keri Marsh Arinsmier.
Picture of A'Gensn Abundant Olive Series Sunscreen Set, www.gnpd.com; published Nov. 20, 2009; 3 pages.
Picture of Alba Botanica Rainforest Arai Gentle Renewal Scrub, www.gnpd.com; published Aug. 3, 2009; 2 pages.
Picture of Almay Pure Blends Makeup SPF 20, www.gnpd.com; published Oct. 12, 2009; 2 pages.
Picture of Atrix Beauty Charge Whitening Hand Cream, www.gnpd.com; published Sep. 30, 2009; 1 page.
Picture of Bobbi Brown ColorOptions Creamy Color, www.gnpd.com; published Sep. 2001; 2 pages.
Picture of Bobbi Brown Lash Glamour, www.gnpd.com; published; May 2003; 1 page.
Picture of Clark's Botanicals Ultra Rich Lip Balm, www.gnpd.com; published Oct. 2007; 2 pages.
Picture of Conceal FX Camouflage Concealer, www.gnpd.com; published Aug. 14, 2009; 3 pages.
Picture of Cristian Lay Bio Salud, www.gnpd.com; published Nov. 4, 2009; 2 pages.
Picture of DeMillus Erva Doce Creme de Mãos (Anise Hand Cream), www.gnpd.com; published Jun. 3, 2009; 2 pages.
Picture of Dr Irena Eris Under Twenty Make-Up Cream, www.gnpd.com; published Nov. 14, 2007; 2 pages.
Picture of Flores & Vegetais Creme Facial Pepino (Cucumber Face Cream), www.gnpd.com; published Nov. 2009; 2 pages.
Picture of Gemey Maybelline Cil Definition Mascara Longueur Cil à Cil Waterproof (Waterproof Lengthening Mascara), www.gnpd.com; published Apr. 2008; 2 pages.
Picture of L'Oréal Cashmere Perfect Soft Powdercreme Makeup, www.gnpd.com; published Mar. 31, 2005; 2 pages.
Picture of Lumene Double Stay Mineral Makeup, www.gnpd.com; published Apr. 7, 2009; 1 page.
Picture of Maybelline Affinitone Perfecting & Protecting Foundation with vitamin E, www.gnpd.com; published Oct. 6, 2009; 2 pages.
Picture of Maybelline Instant Smooth Result Foundation, www.gnpd.com; published Dec. 4, 2006; 1 page.
Picture of Miss Sporty Studio Lash Eye Opening & Lash Sculpting Mascara, www.gnpd.com; published Jun. 2008; 2 pages.
Picture of Natura Faces Base Extra Leve FPS 8 (Extra-Soft Foundation SPF 8), www.gnpd.com; published Oct. 26, 2009; 2 pages.
Picture of Neutrogena 3-In-1 Concealer For Eyes, www.gnpd.com; published Apr. 2007; 3 pages.
Picture of Neutrogena Healthy Skin Glow Sheers Foundation, www.gnpd.com; Apr. 2007; 3 pages.
Picture of Neutrogena Norwegische Formel (Anti-Callosity Foot Creme), www.gnpd.com; published Aug. 2007; 2 pages.
Picture of Neutrogena Reafirmante Corporal (Firming Body Moisturizer), www.gnpd.com; published May 2007; 2 pages.
Picture of No. 7 Essential Moisture Foundation SPF 12, www.gnpd.com; published Jun. 2006; 2 pages.
Picture of Only Acne Oil Control Facial Cleansing Foam, www.gnpd.com; published Sep. 10, 2009; 1 page.
Picture of Palmer's Olive Oil Formula Regenerating Conditioner, www.gnpd.com; published Mar. 2008; 2 pages.

Picture of Physicians Formula Lash-in-a-Tube Full Coverage Cream Mascara, www.gnpd.com; published Feb. 2004; 2 pages.

Picture of Physicians Formula Organic Wear Fair to Light Tinted Moisturizer, www.gnpd.com; published Jan. 2008; 3 pages.

Picture of Purab Green Herbal Foam, www.gnpd.com; published May 05, 2009; 1 page.

Picture of Revlon ColorStay Mineral Mousse Foundation, www.gnpd.com; published Nov. 26, 2009; 1 page.

Picture of Revlon Colorstay Mineral Mousse Makeup, www.gnpd.com; published May 28, 2009; 2 pages.

Picture of Rimmel Stay Matte Clarifying Matte Foundation, www.gnpd.com; published Jan. 28, 2009; 2 pages.

Picture of Rimmel Stay Matte, www.gnpd.com; published Nov. 13, 2009; 2 pages.

Picture of Sahra Creme de Arnica com Mentol Arnica Cream with Menthol, www.gnpd.com; published Jun. 2005; 2 pages.

Picture of Universo Garden Angels Gel Revitalizante para Piernas Cansadas (Revitalizing Gel for Tired Legs), www.gnpd.com; published Nov. 6, 2009; 1 page.

Picture of Victoria's Secret Beauty Rush Mascara, www.gnpd.com; published Dec. 2008; 2 pages.

* cited by examiner

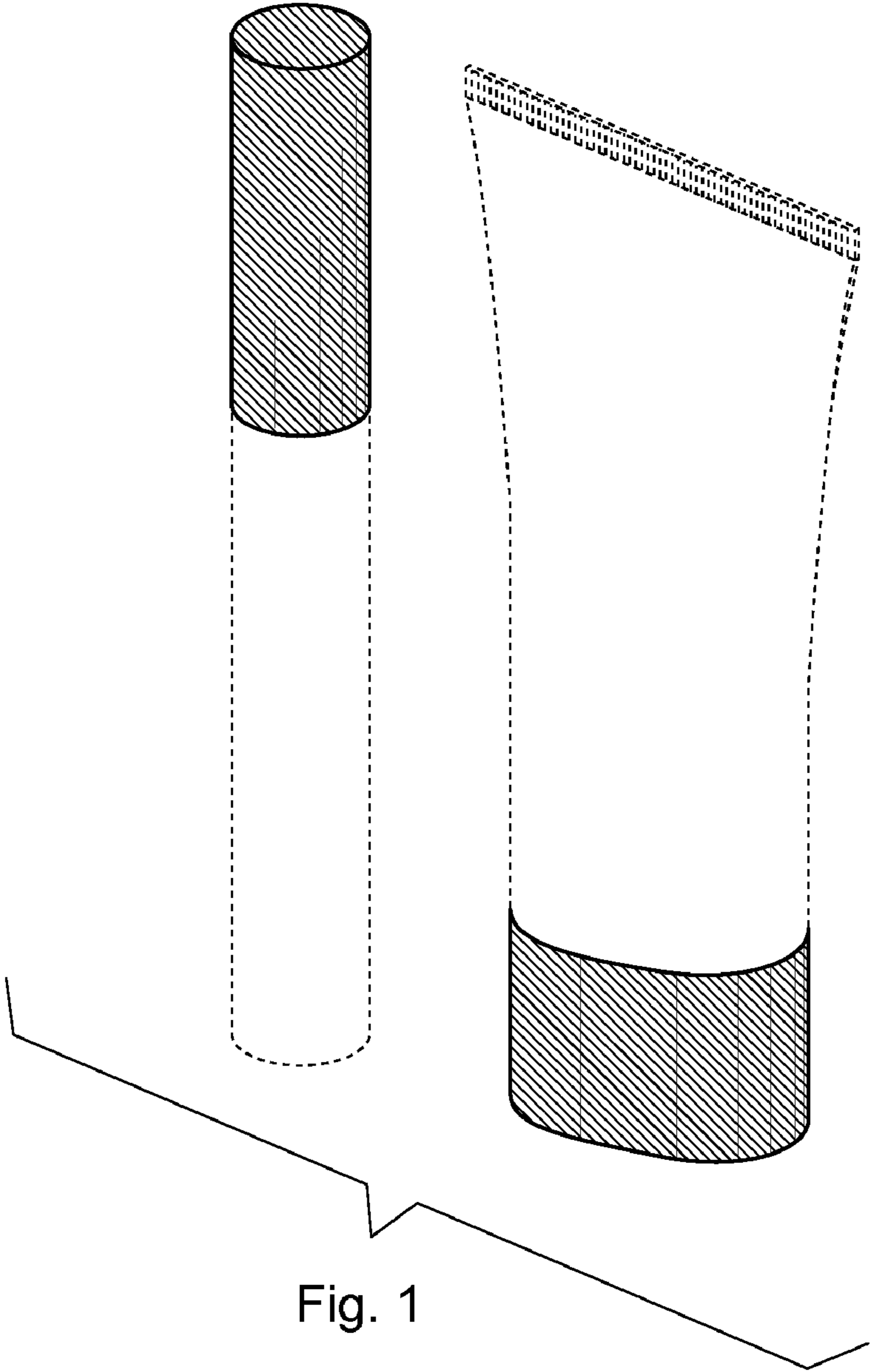

Fig. 1

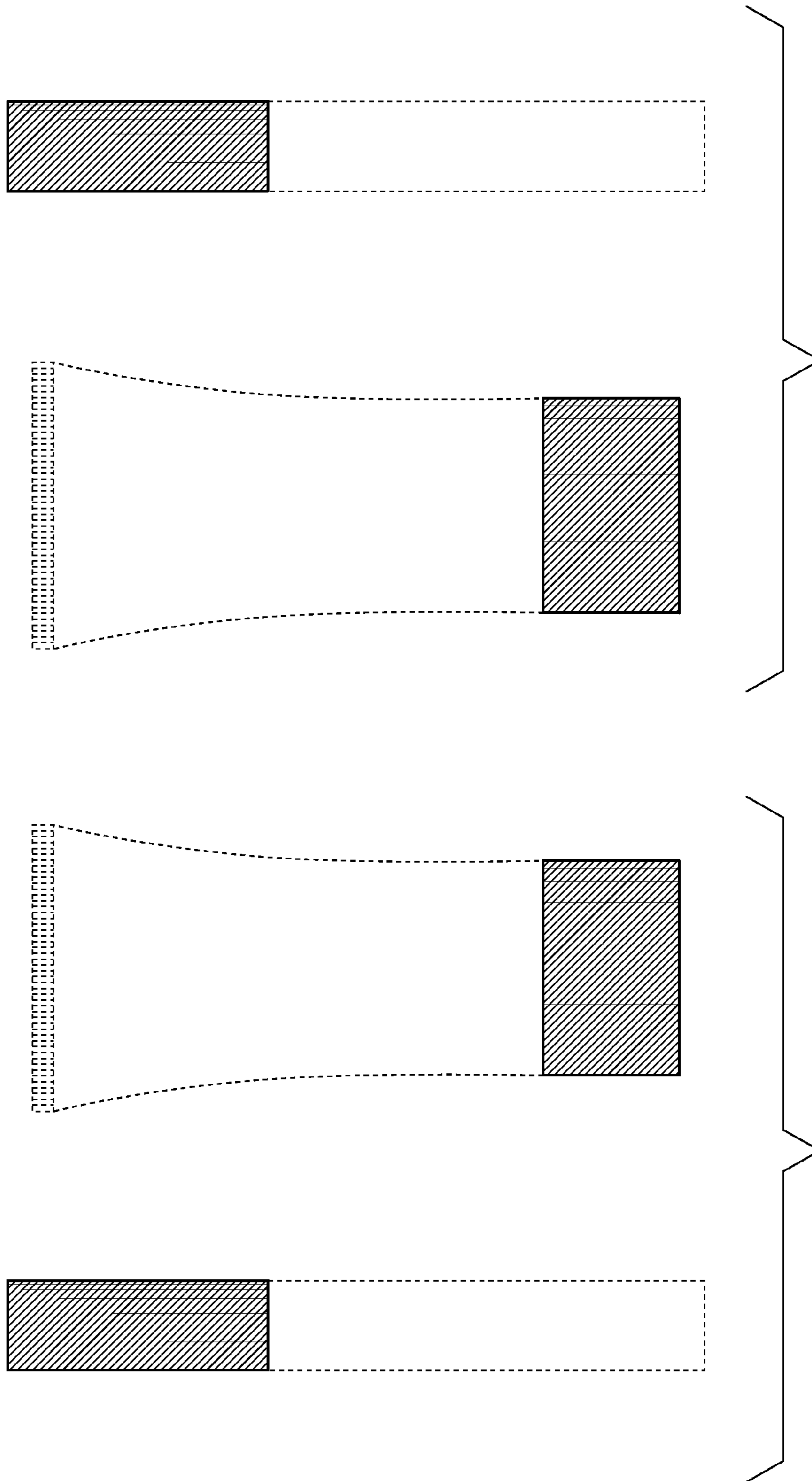

Fig. 2

Fig. 3

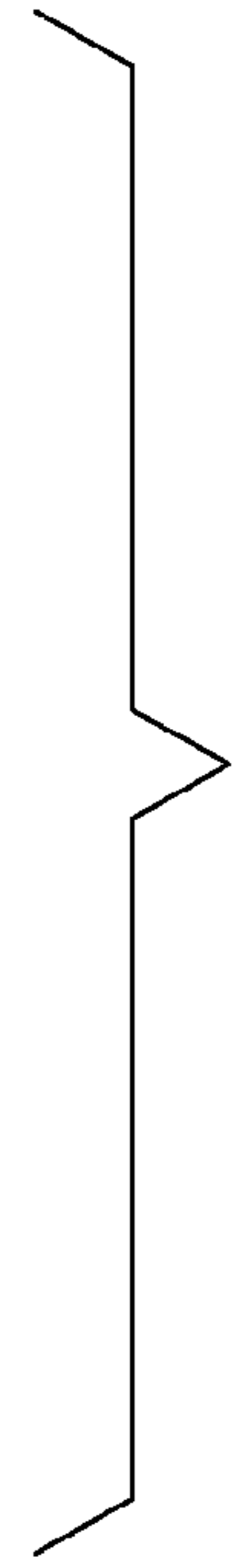
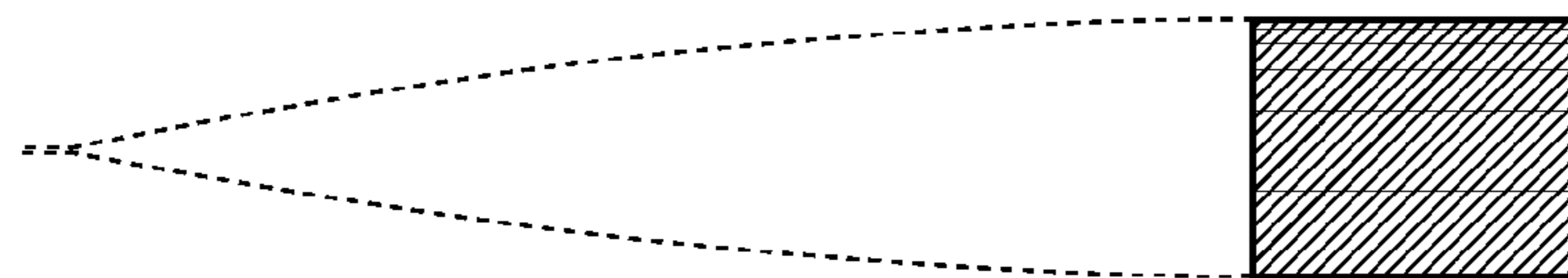
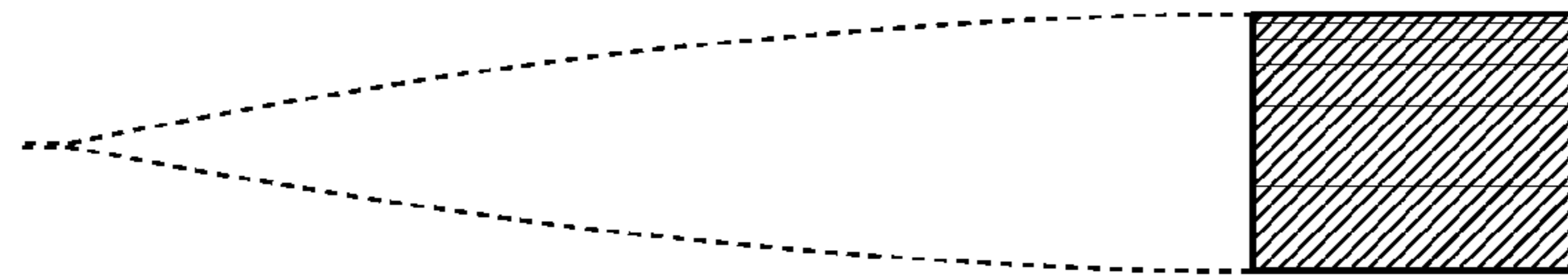

Fig. 5

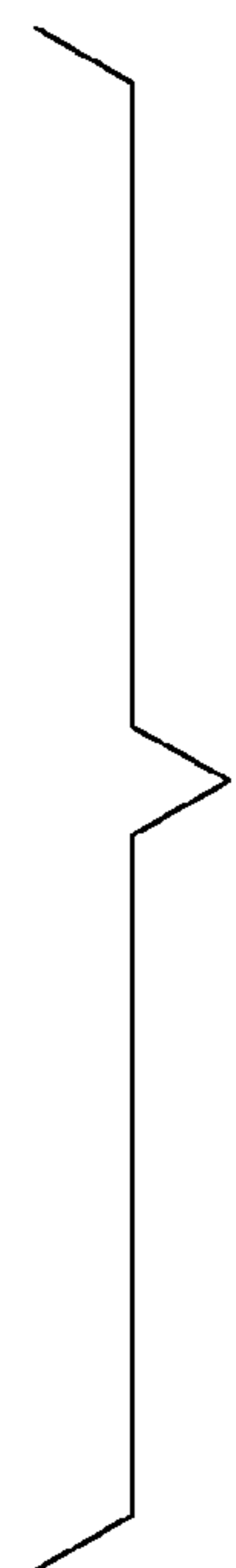

Fig. 4

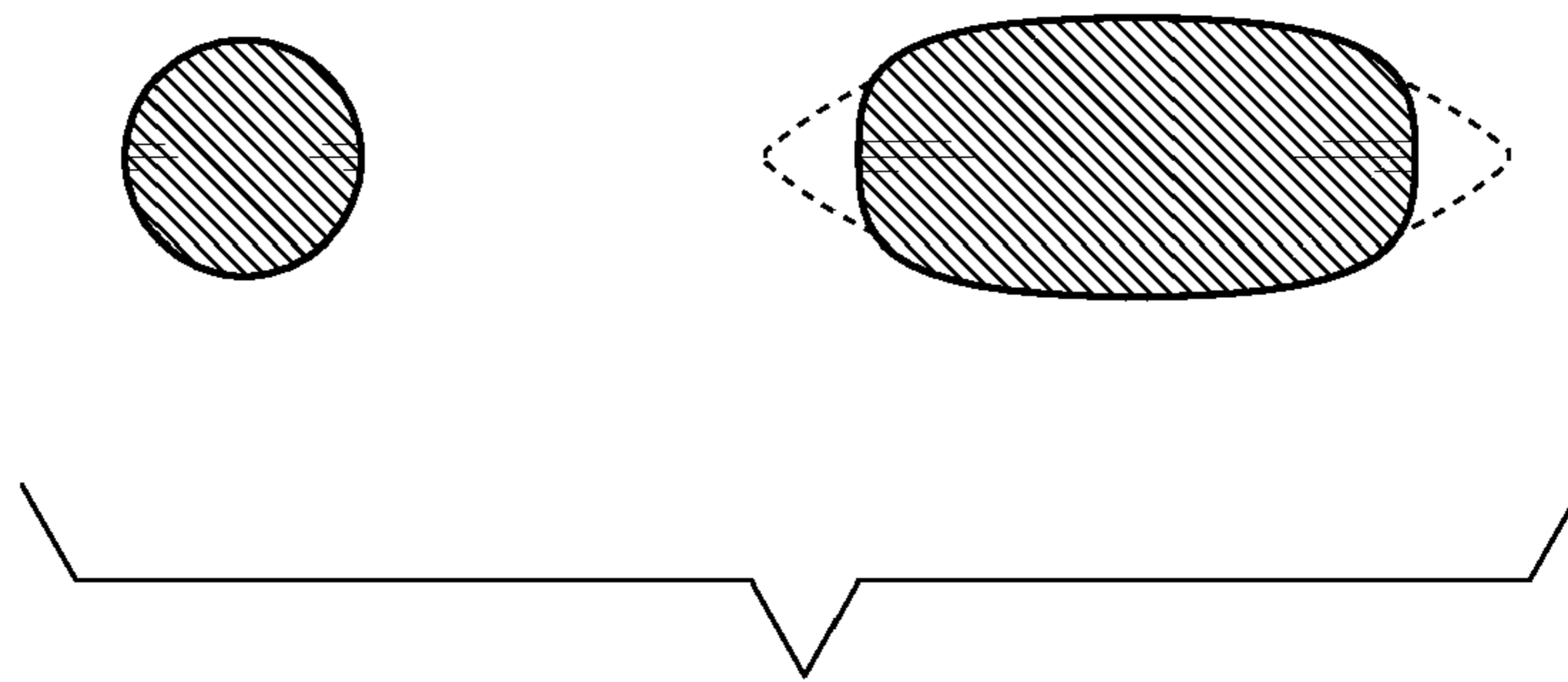

Fig. 6

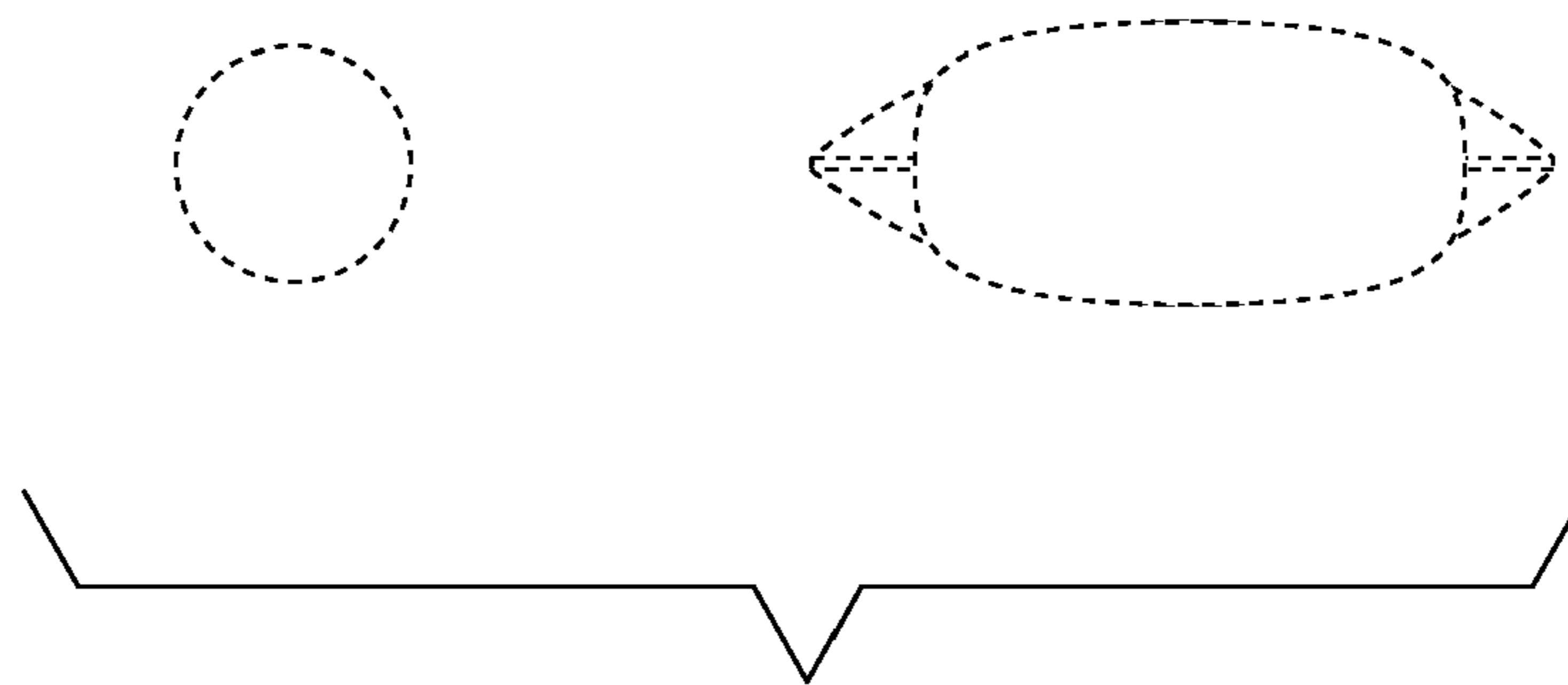
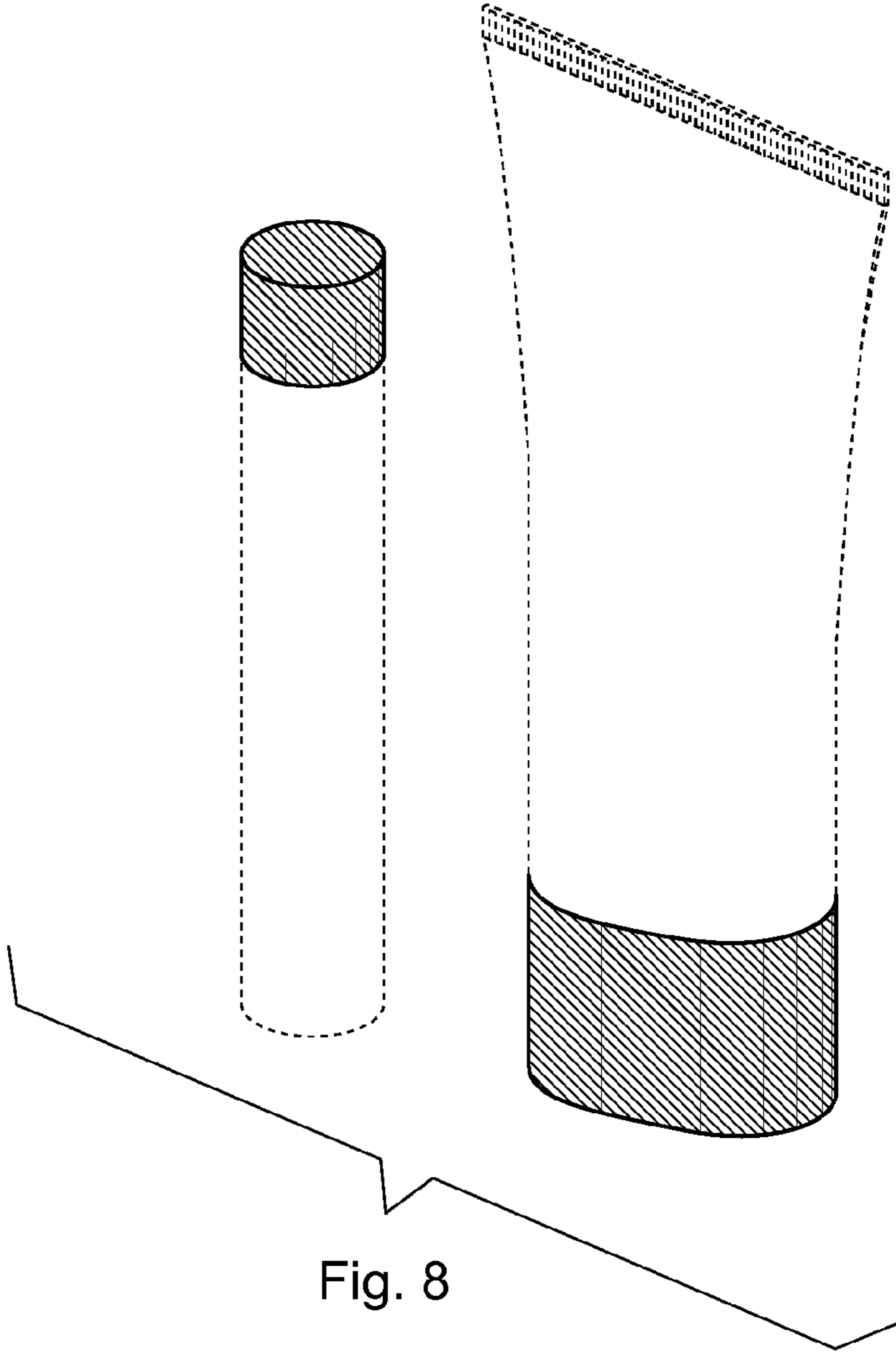
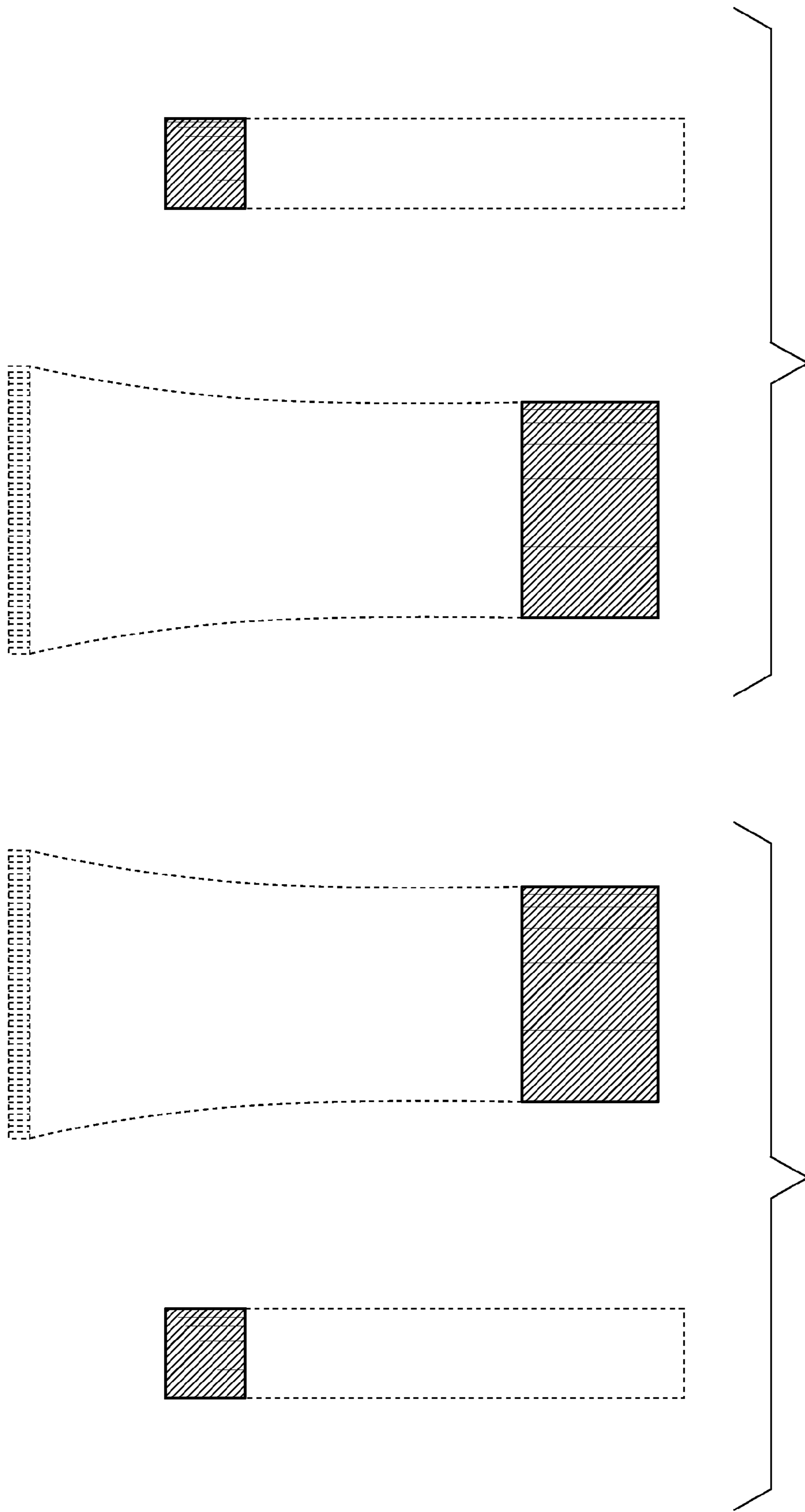

Fig. 7





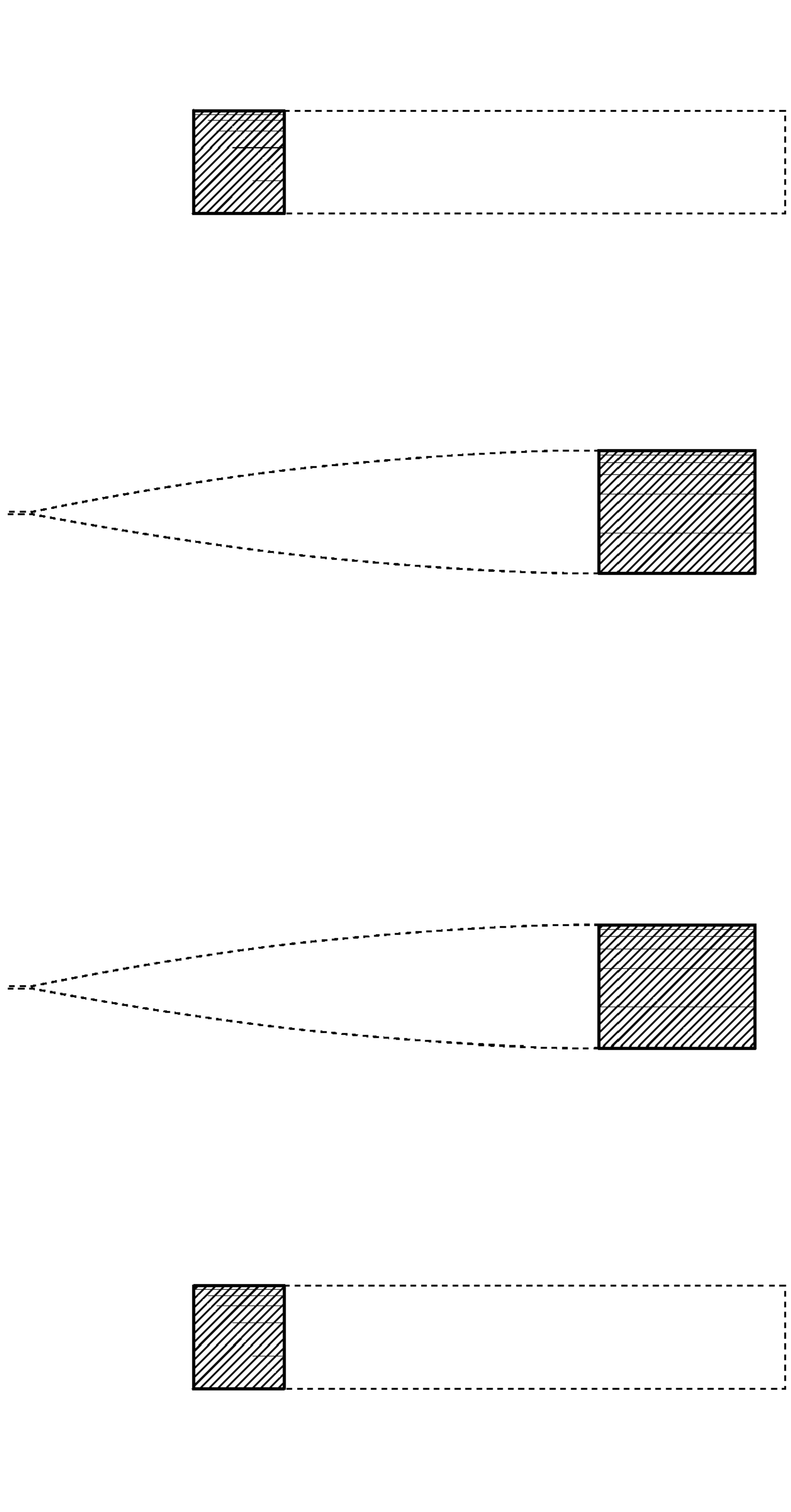

Fig. 12

Fig. 11

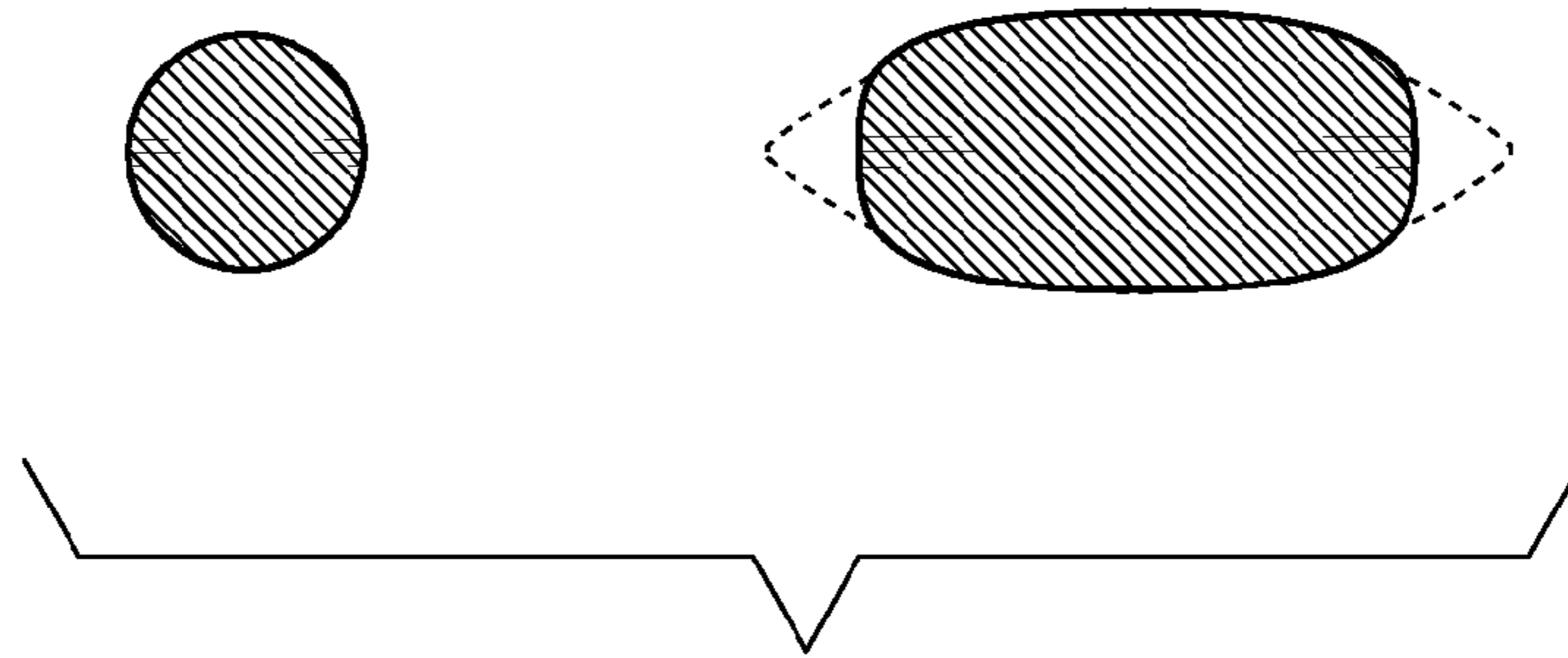

Fig. 13

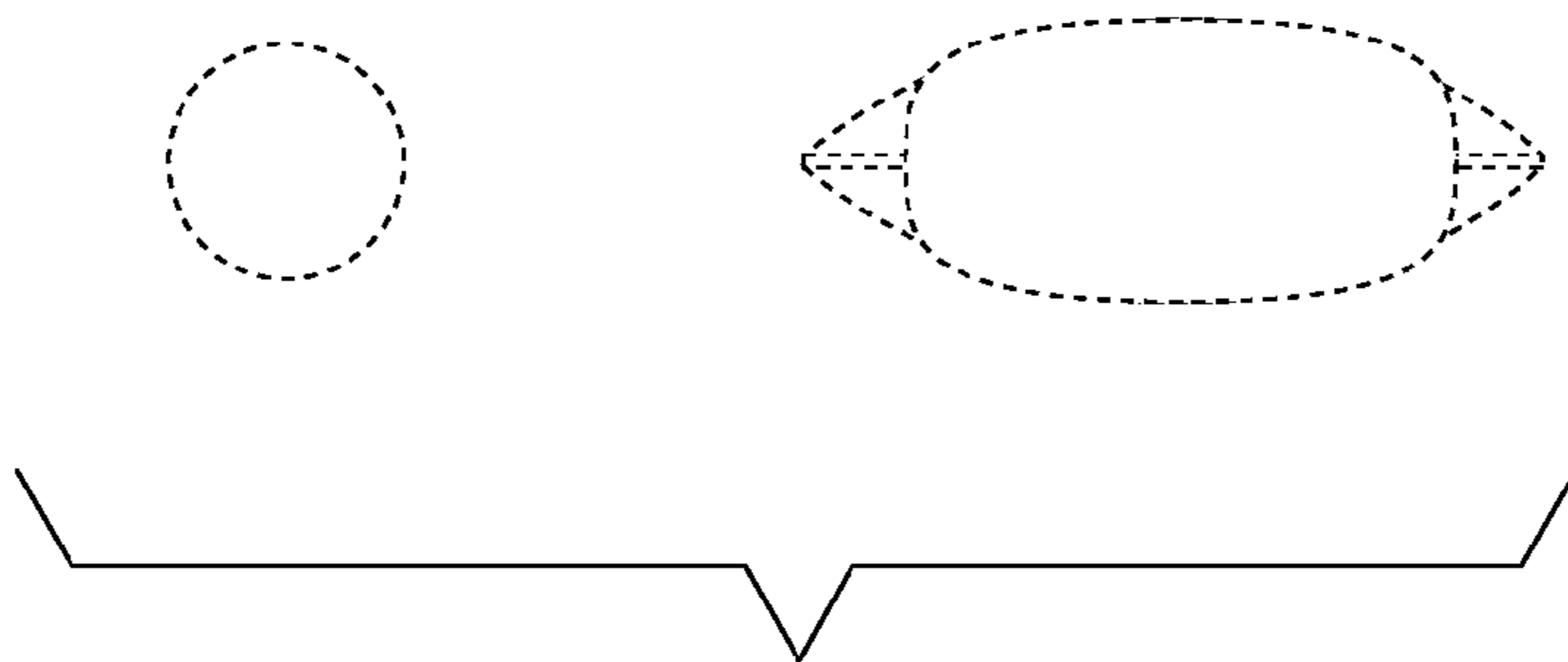

Fig. 14