



US00D673225S

(12) **United States Design Patent**
Heidrich

(10) **Patent No.:** **US D673,225 S**

(45) **Date of Patent:** **** *Dec. 25, 2012**

(54) **COMBINED POM POM AND BALL REPLICA
HOLDER THEREFOR**

(76) Inventor: **Gary Heidrich**, Bloomfield Hills, MI
(US)

(*) Notice: This patent is subject to a terminal dis-
claimer.

(**) Term: **14 Years**

(21) Appl. No.: **29/370,547**

(22) Filed: **Aug. 3, 2010**

(51) **LOC (9) Cl.** **21-01**

(52) **U.S. Cl.** **D21/400**

(58) **Field of Classification Search** D21/398,
D21/400, 405, 406, 465, 468, 483, 707-714,
D21/811, 812; D20/10, 12, 19, 29, 99; D2/613-615;
D11/157, 168, 172; D10/109.1, 109.2; D30/160;
D19/42, 54, 57; D12/400, 190, 191, 197,
D12/199; 446/26, 27, 327, 486, 487, 490,
446/491; 40/586, 590-593, 597, 606.1, 606.06,
40/606.12; 116/28 R, 209, 278, 306, 307,
116/169, 173-175, DIG. 7, DIG. 8; 428/4,
428/6, 7, 9, 11, 12, 28, 31; 473/569-614;
119/707-711

See application file for complete search history.

(56) **References Cited**

U.S. PATENT DOCUMENTS

D49,090	S	*	5/1916	Gregory	D21/440
D63,059	S	*	9/1923	Page	D21/439
2,531,853	A	*	11/1950	Larman	446/27
D191,585	S	*	10/1961	Miller	D21/400
D244,236	S	*	5/1977	Kyle	D29/122
D259,354	S	*	5/1981	Derrington	D21/707
4,369,215	A	*	1/1983	Offen et al.	428/4
D272,550	S	*	2/1984	Esposti	D21/406
4,454,204	A	*	6/1984	Posey	428/542.4
D284,487	S	*	7/1986	Pratt	D21/400
5,079,046	A	*	1/1992	Kessler	428/4
D405,926	S	*	2/1999	Badillo	D28/63
D488,946	S	*	4/2004	Long et al.	D6/597
D488,947	S	*	4/2004	Long et al.	D6/597

D500,424	S	*	1/2005	Long et al.	D6/597
D523,190	S	*	6/2006	Oblack	D30/160
D598,057	S	*	8/2009	Garcia	D21/405
D636,029	S	*	4/2011	Jarrett	D20/29
2001/0034177	A1	*	10/2001	Hunn	446/73
2003/0019139	A1	*	1/2003	Cook	40/591

* cited by examiner

Primary Examiner — Catherine Tuttle

(74) *Attorney, Agent, or Firm* — John R. Benefiel

(57) **CLAIM**

The ornamental design for the combined pom pom and ball replica holder therefor, as shown and described.

DESCRIPTION

FIG. 1 is a perspective view of the combined pom pom and ball replica holder therefor showing a first embodiment of my new design simulating a basketball;

FIG. 2 is a front view of FIG. 1, the rear view being identical thereto;

FIG. 3 is a right side view of FIG. 1, the left side view being identical thereto;

FIG. 4 is a top view of FIG. 1;

FIG. 5 is a bottom view of FIG. 1;

FIG. 6 is a perspective view showing a second embodiment of my new design simulating a soccer ball;

FIG. 7 is a front view of FIG. 6;

FIG. 8 is a right side view of FIG. 6;

FIG. 9 is a top view of FIG. 6;

FIG. 10 is a bottom view of FIG. 6;

FIG. 11 is a perspective view showing a third embodiment of my new design simulating a baseball;

FIG. 12 is a front view of FIG. 11;

FIG. 13 is a right side view of FIG. 12, the left side view being a mirror image thereof;

FIG. 14 is a top view of FIG. 13;

FIG. 15 is a bottom view of FIG. 14;

FIG. 16 is a perspective view showing a fourth embodiment of my new design simulating a volleyball;

FIG. 17 is a front view of FIG. 16, the rear view being identical;

FIG. 18 is a right side view of FIG. 16, the left side view being identical thereto;

FIG. 19 is a top view of FIG. 16; and,

FIG. 20 is a bottom view of FIG. 16.

1 Claim, 16 Drawing Sheets

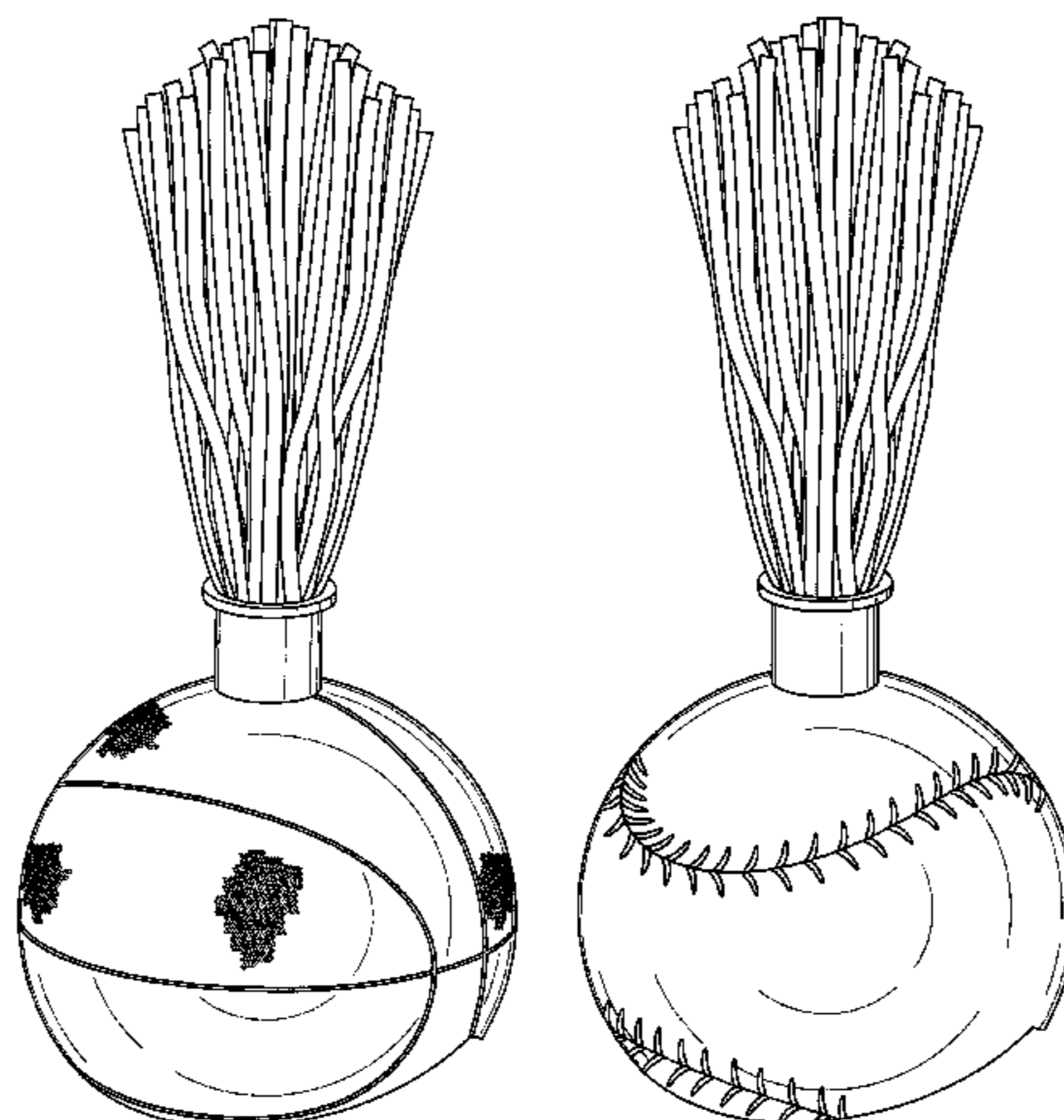
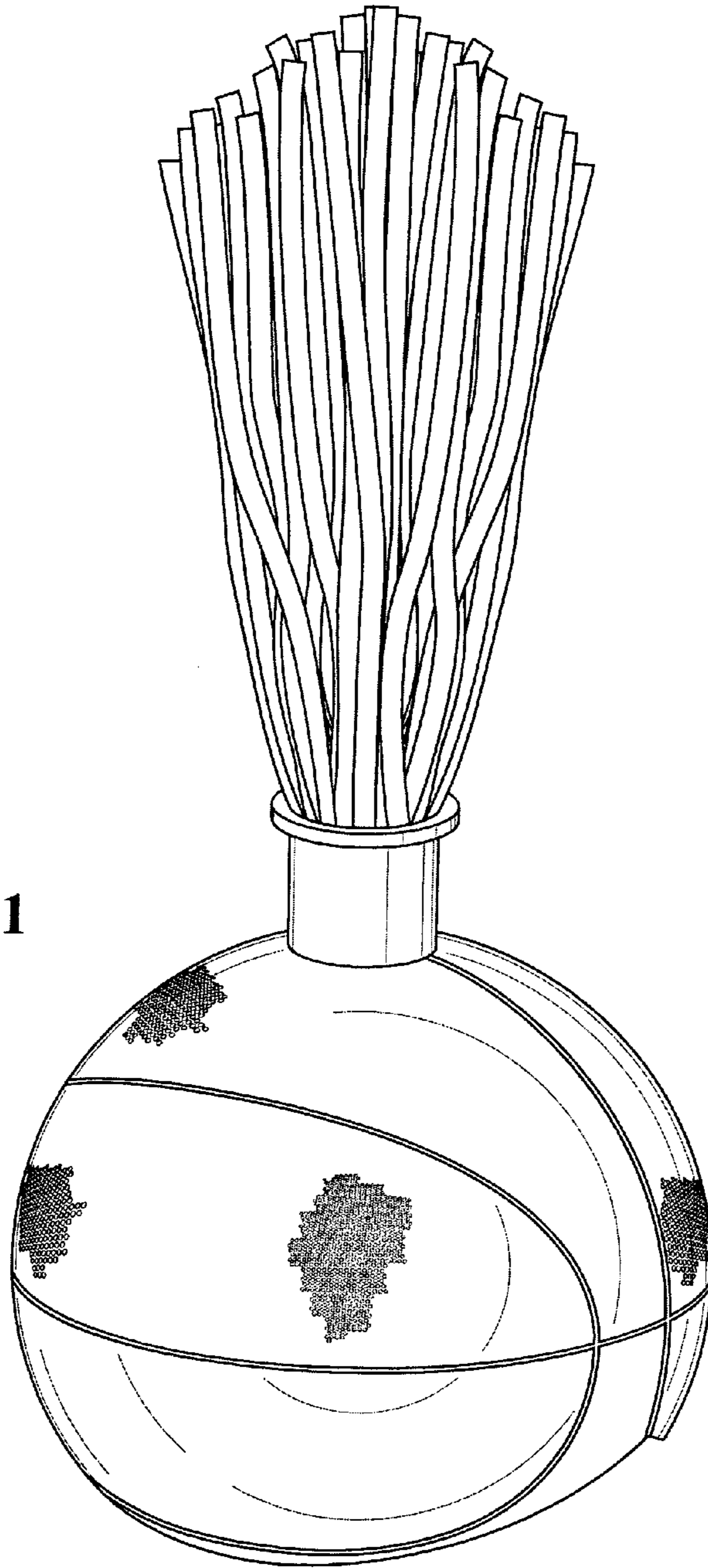

FIG. 1



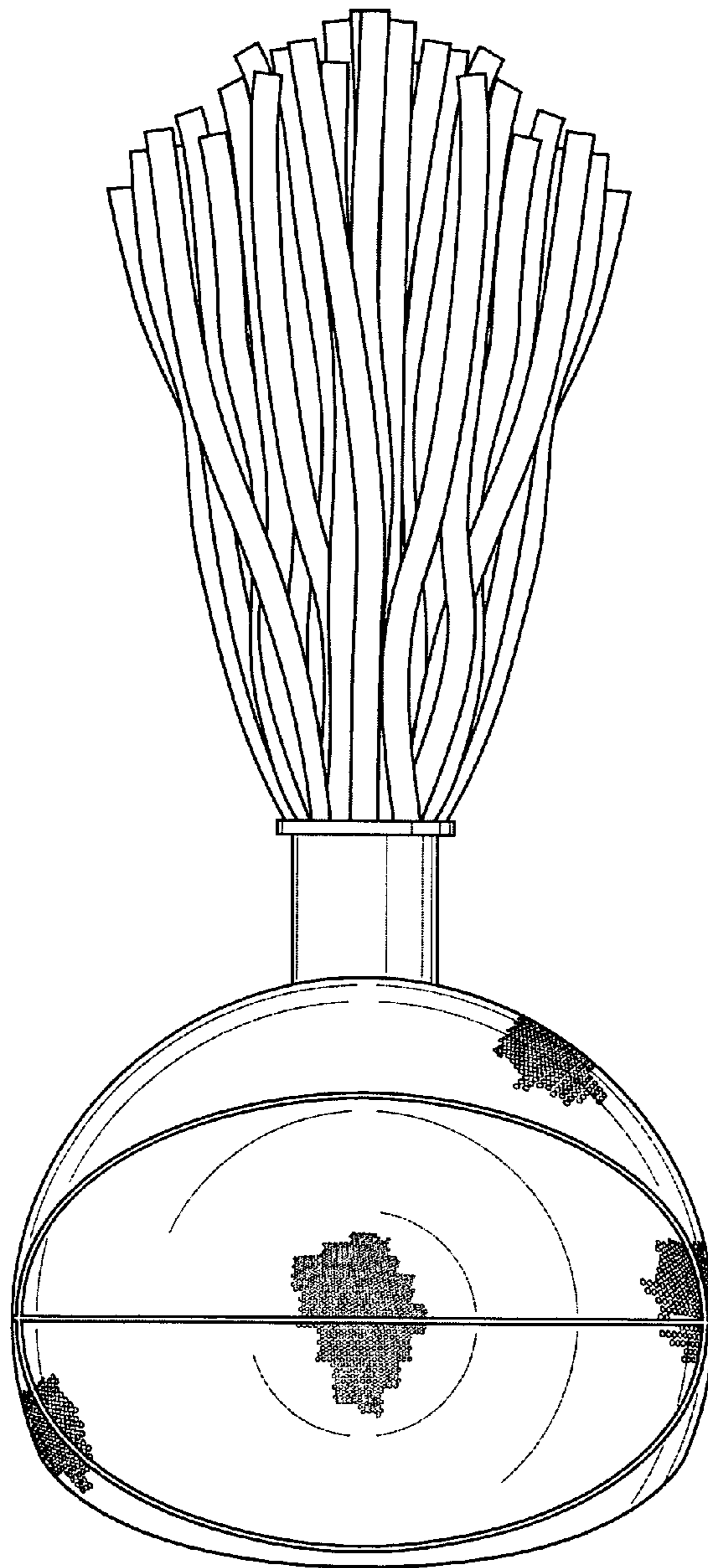

FIG. 2

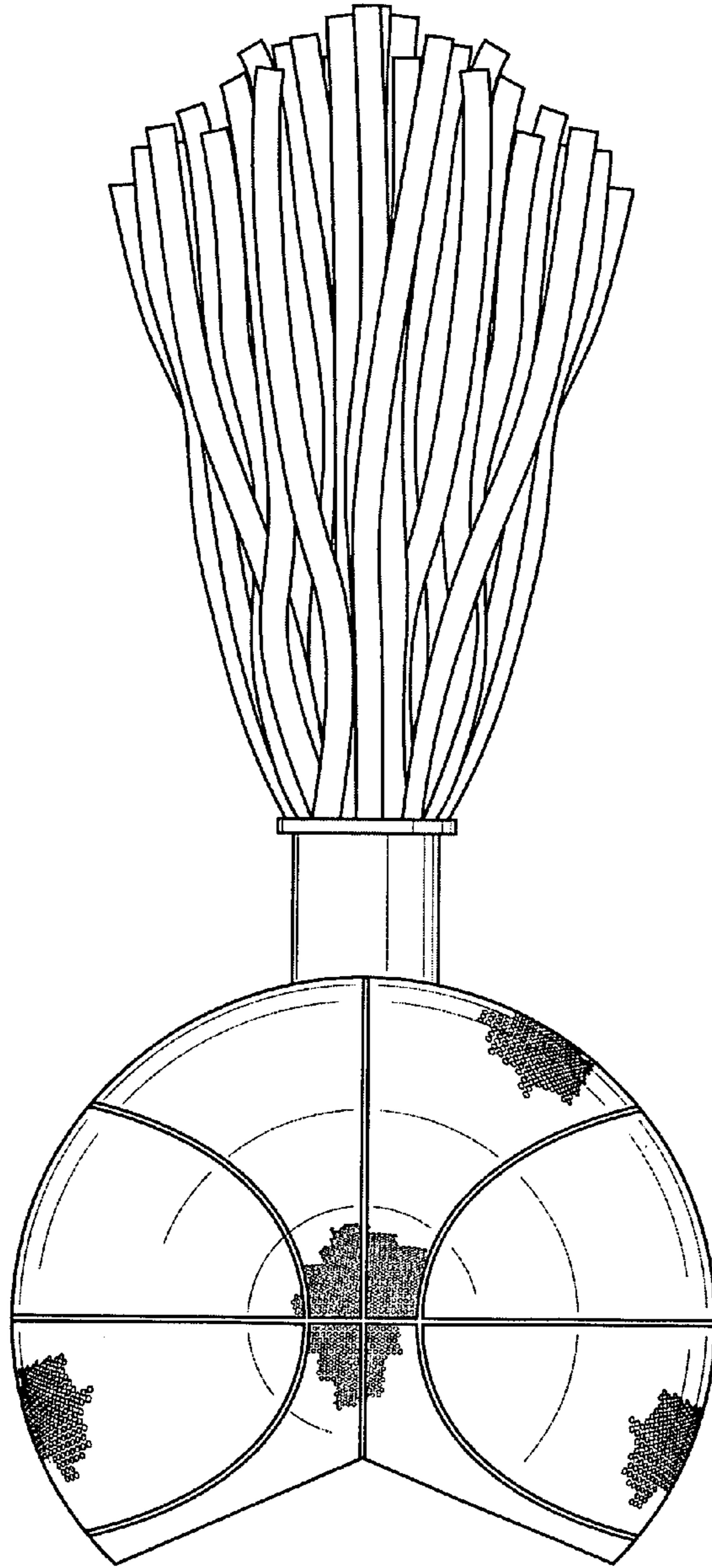

FIG. 3

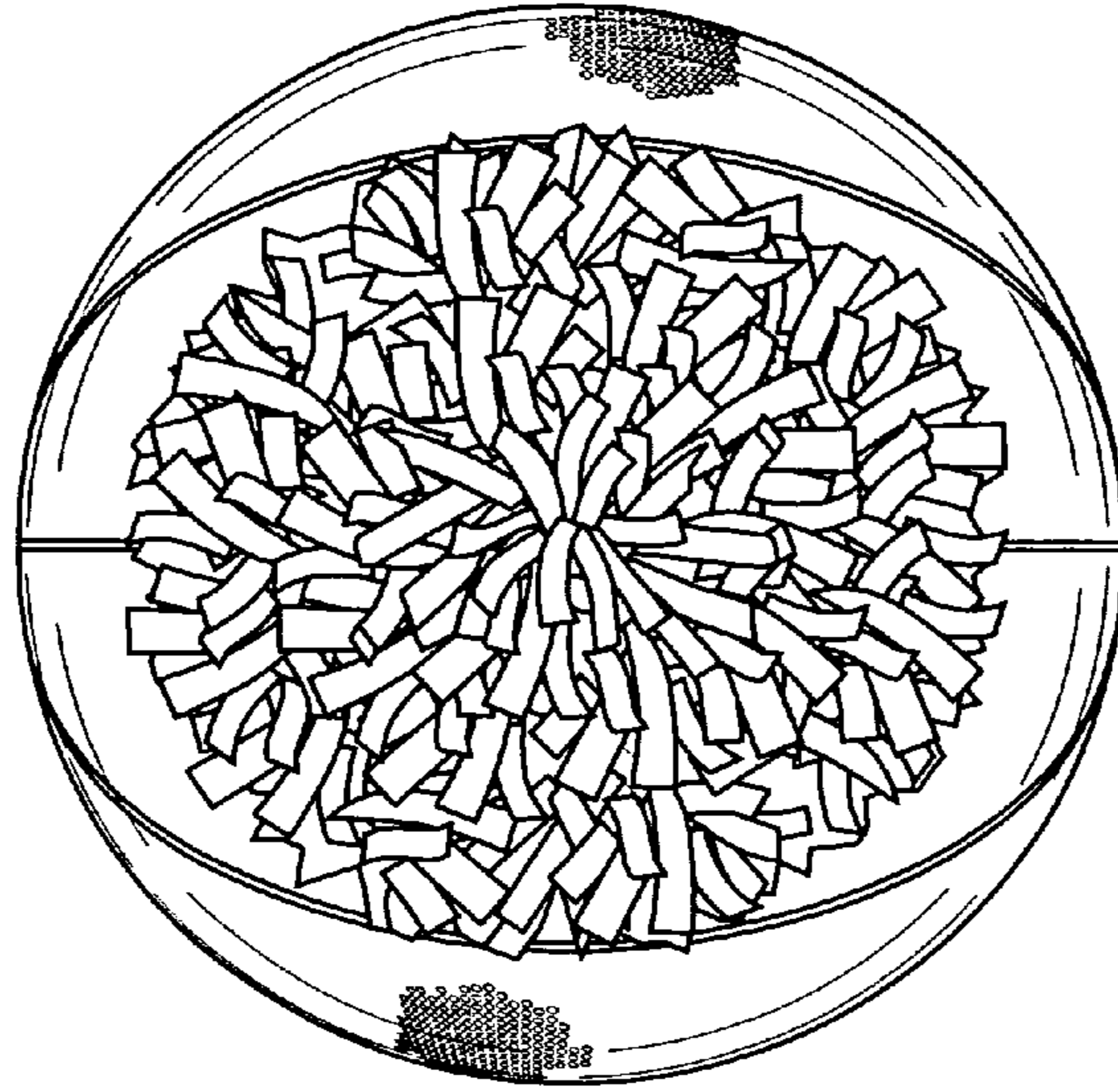

FIG. 4

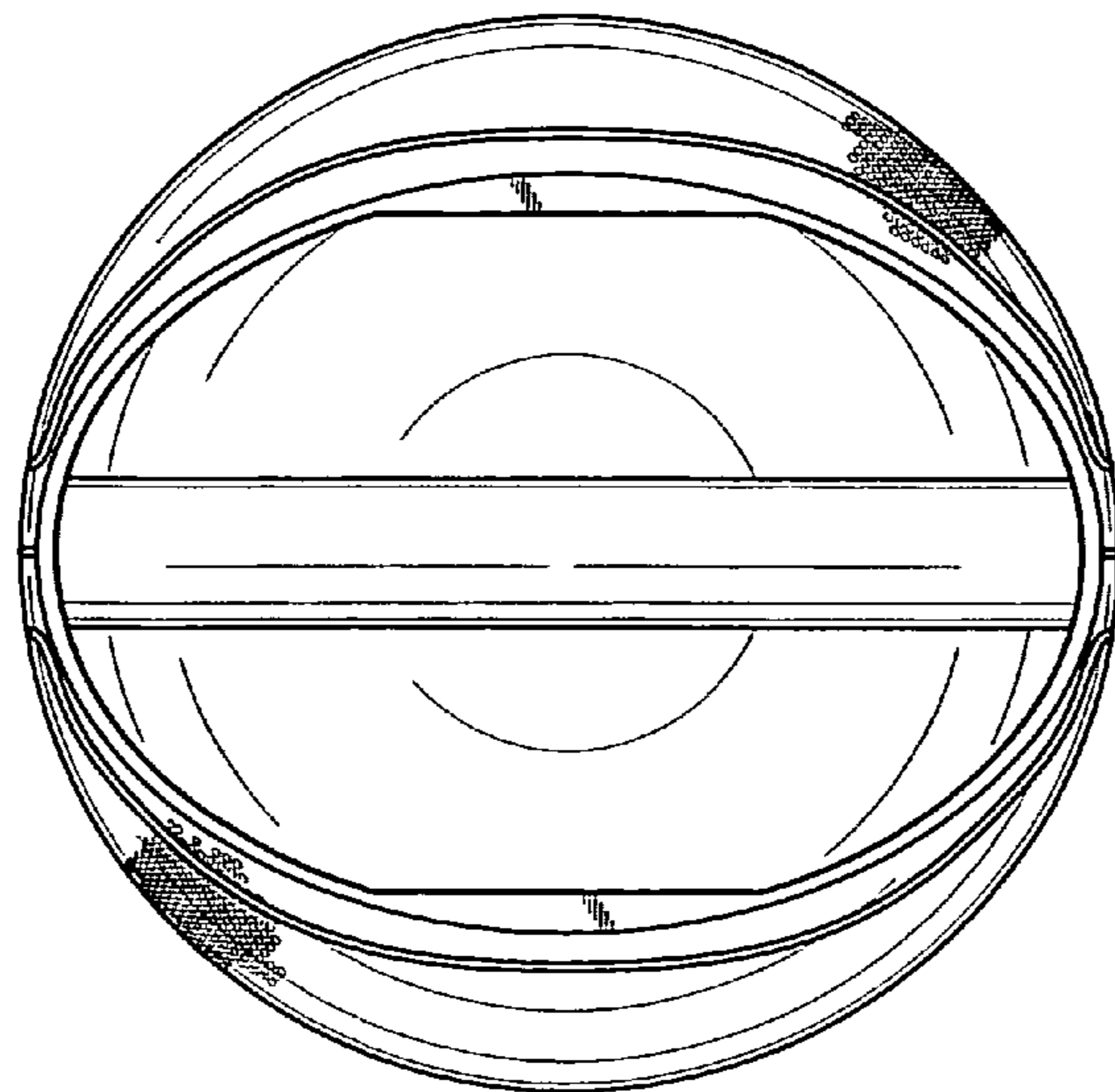
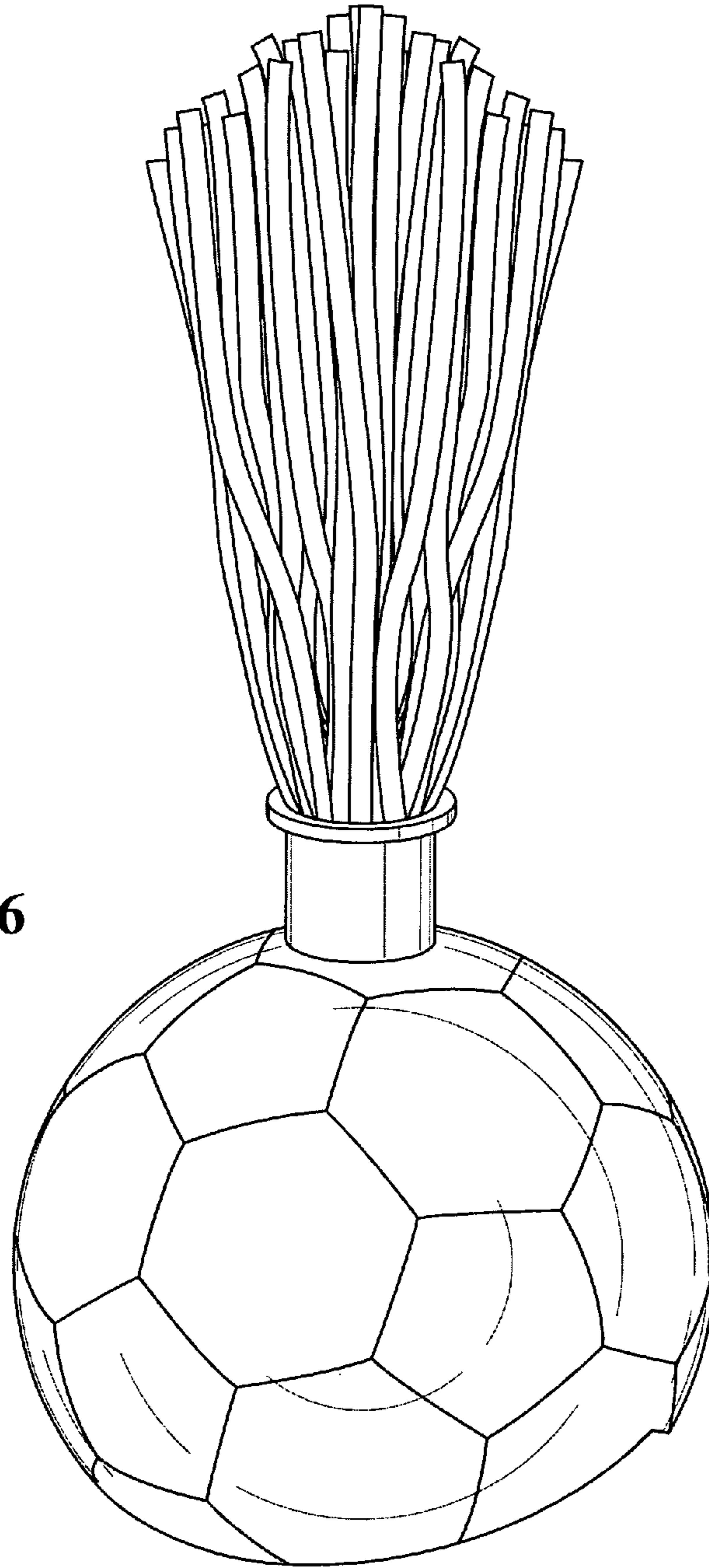

FIG. 5

FIG. 6



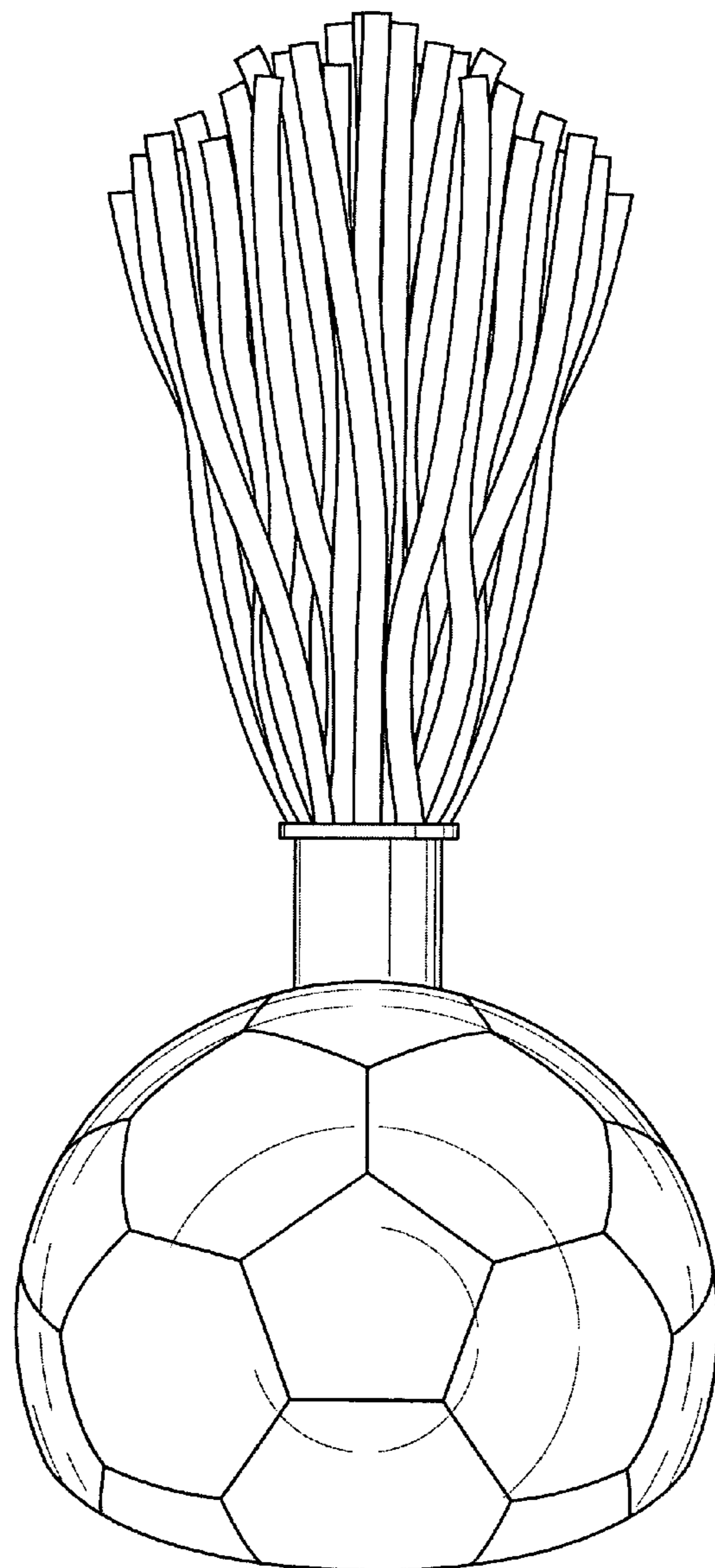

FIG. 7

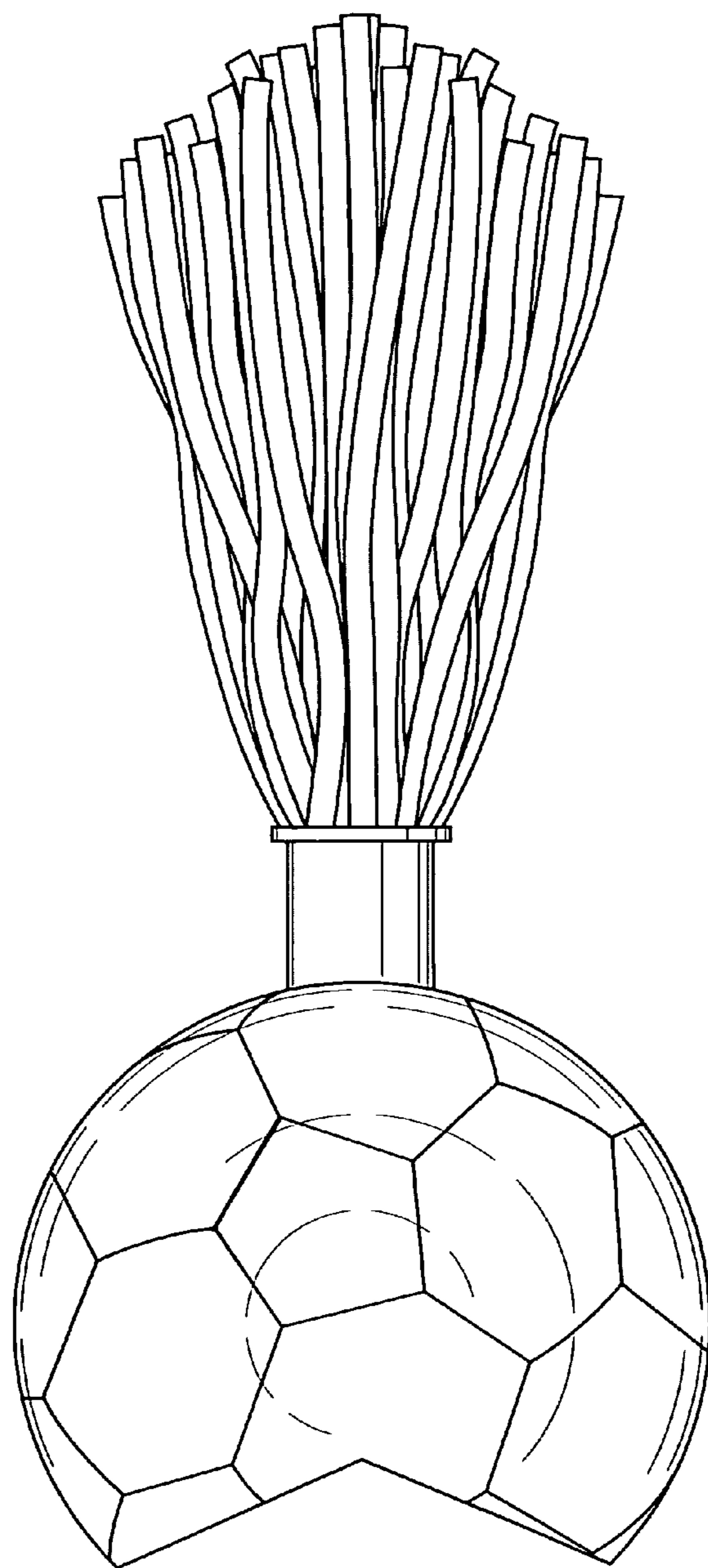

FIG. 8

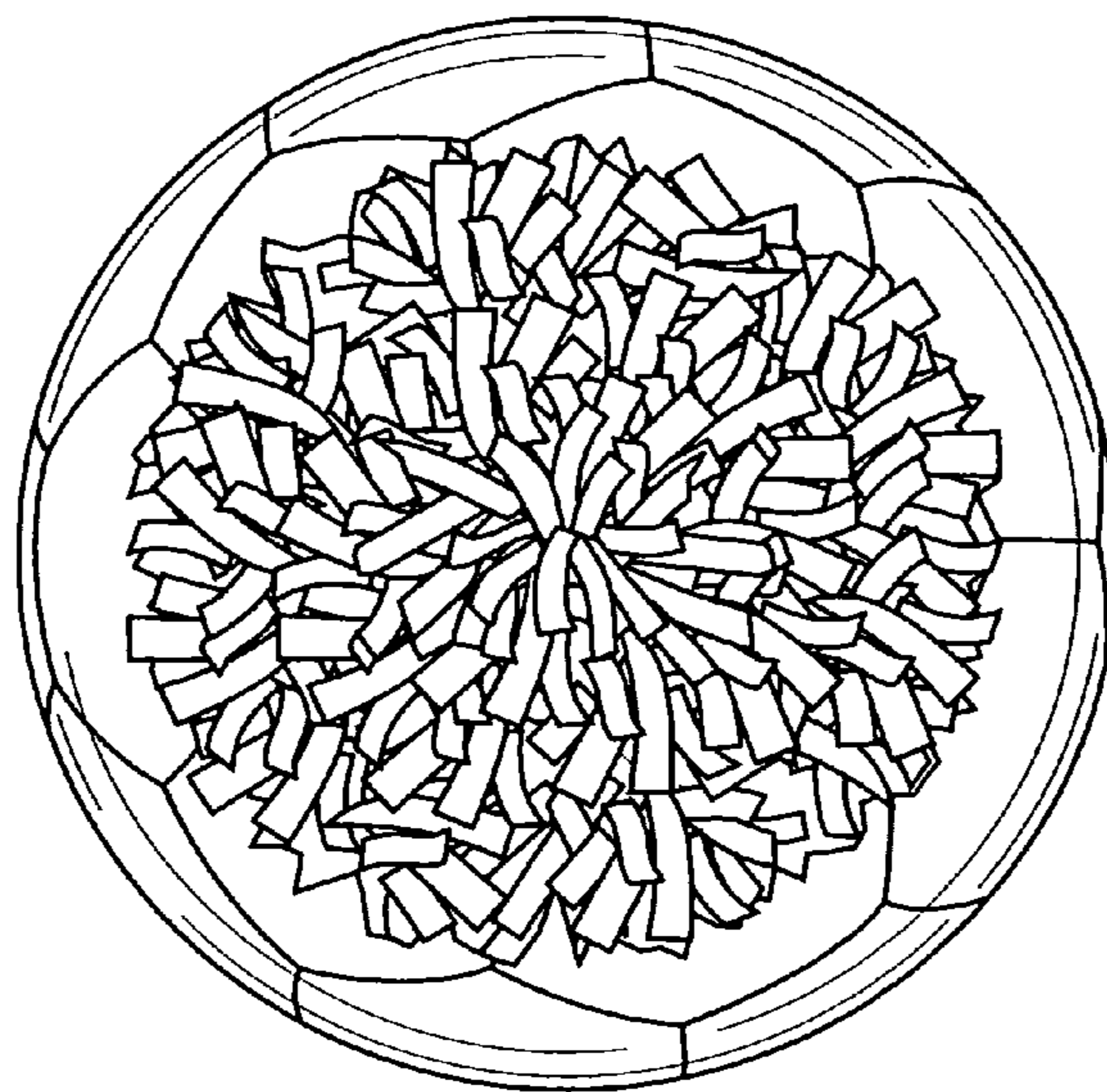

FIG. 9

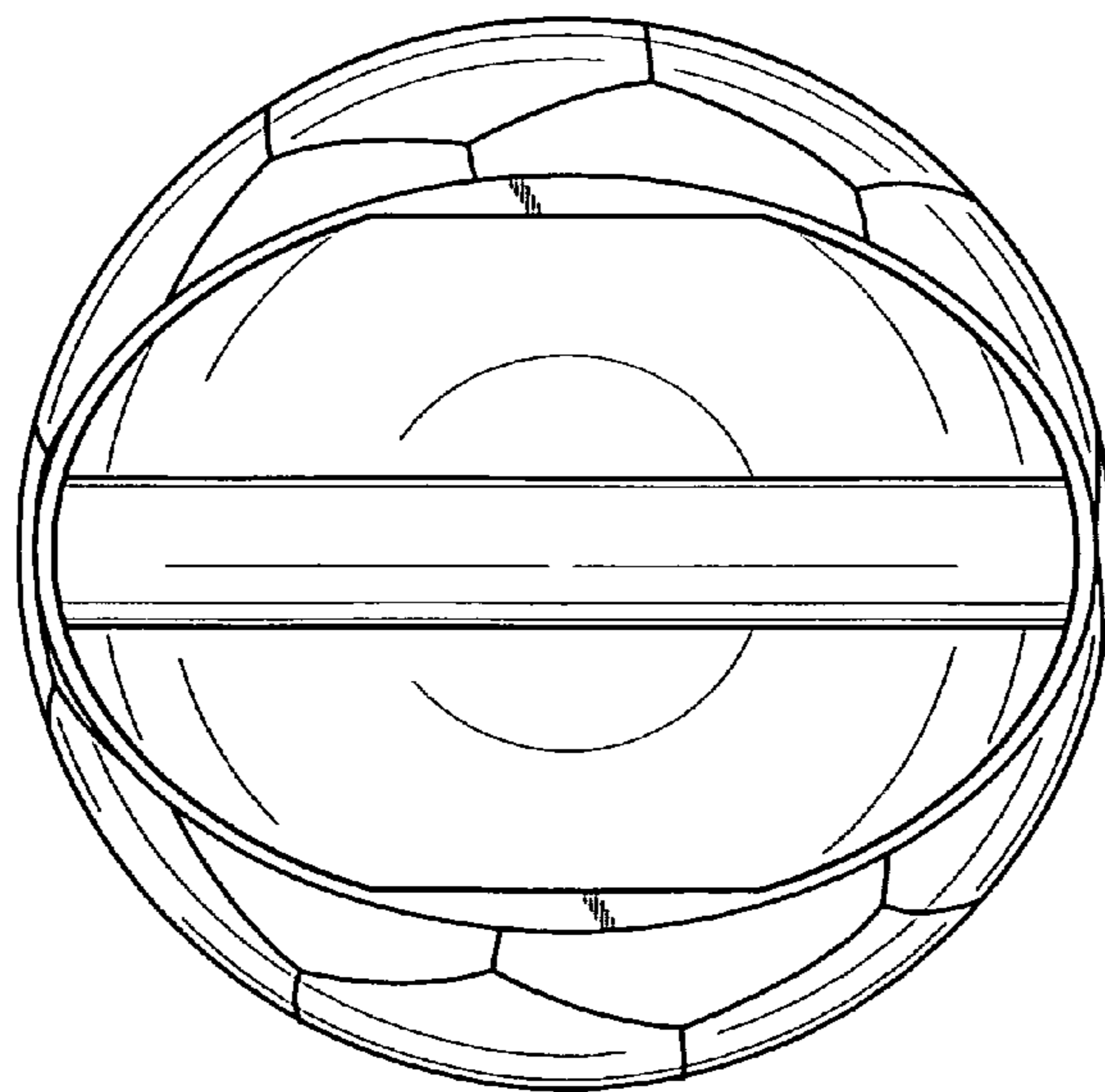
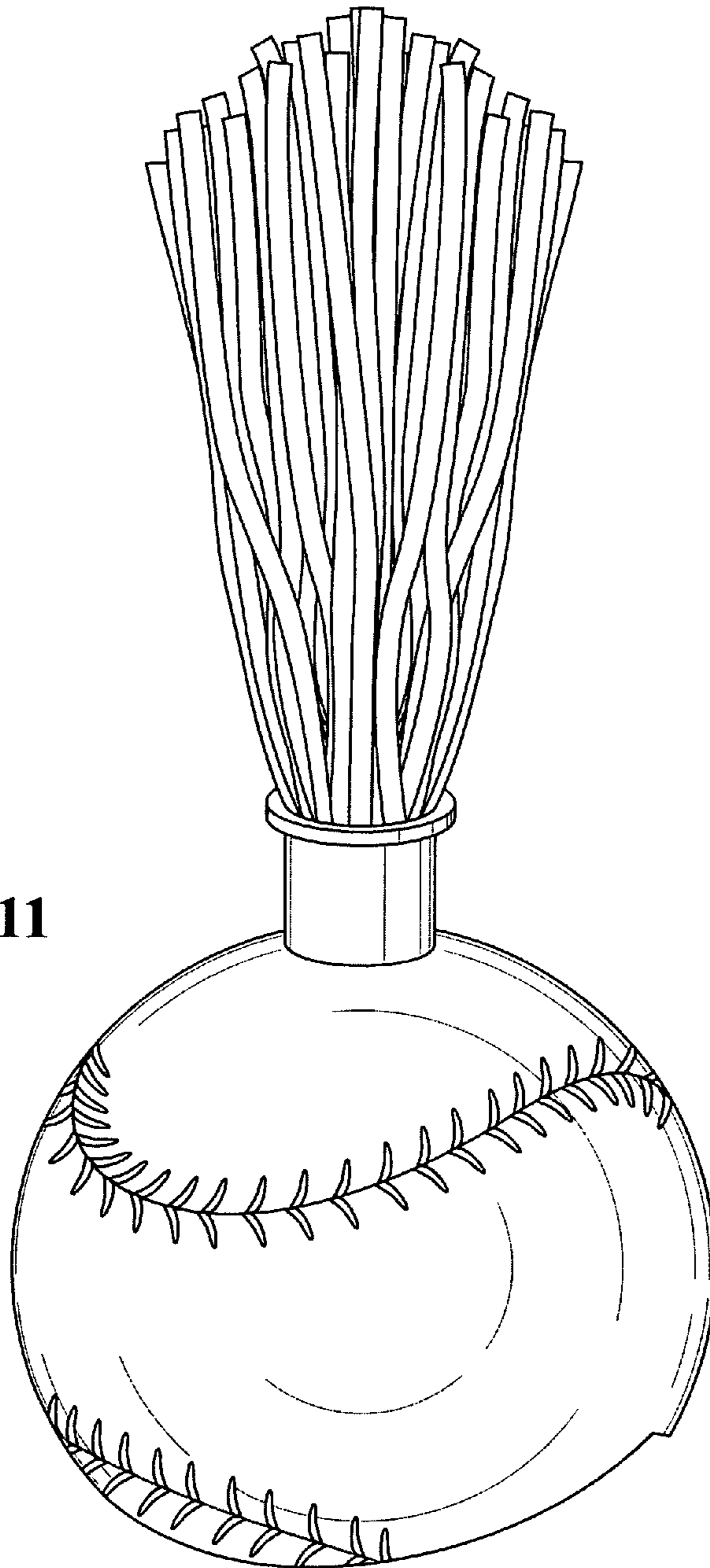

FIG. 10

FIG. 11



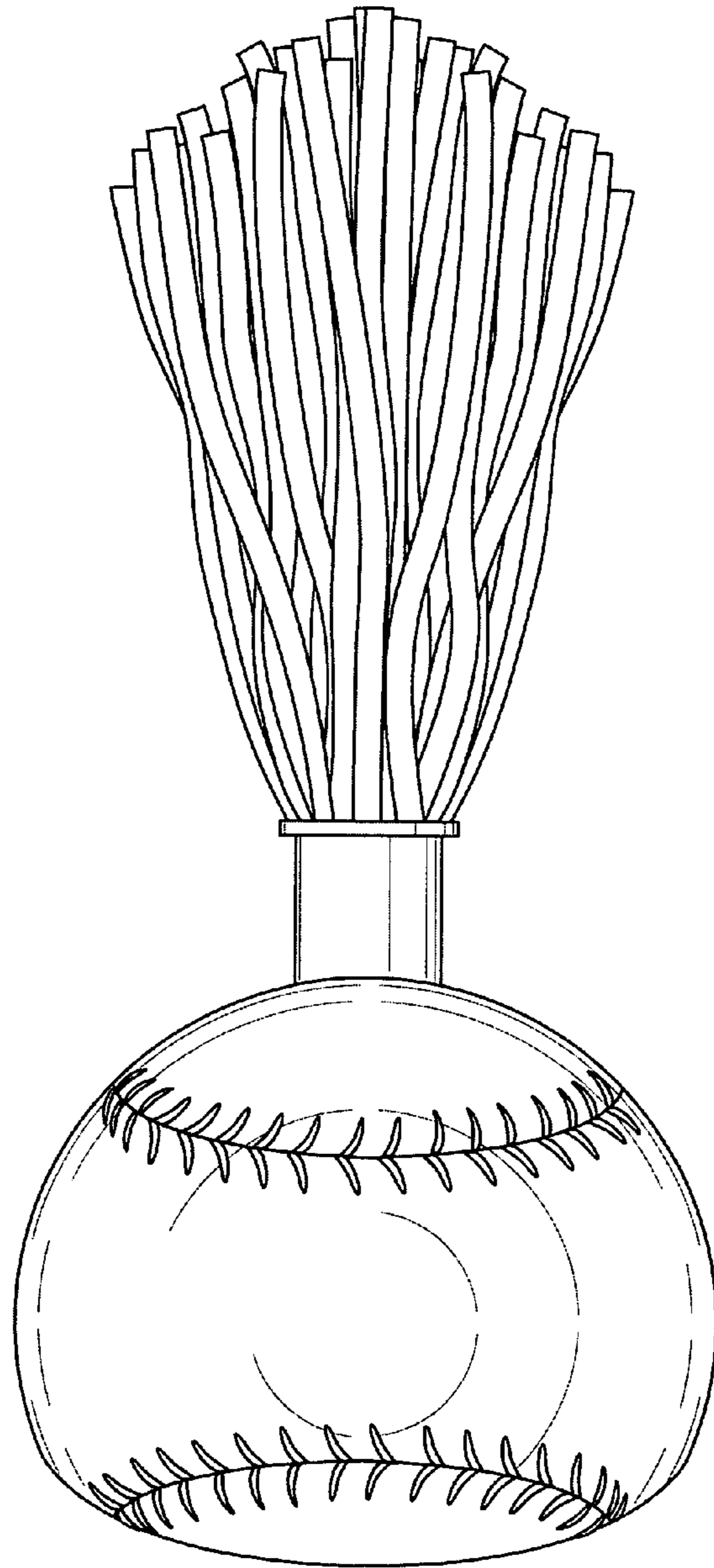

FIG. 12

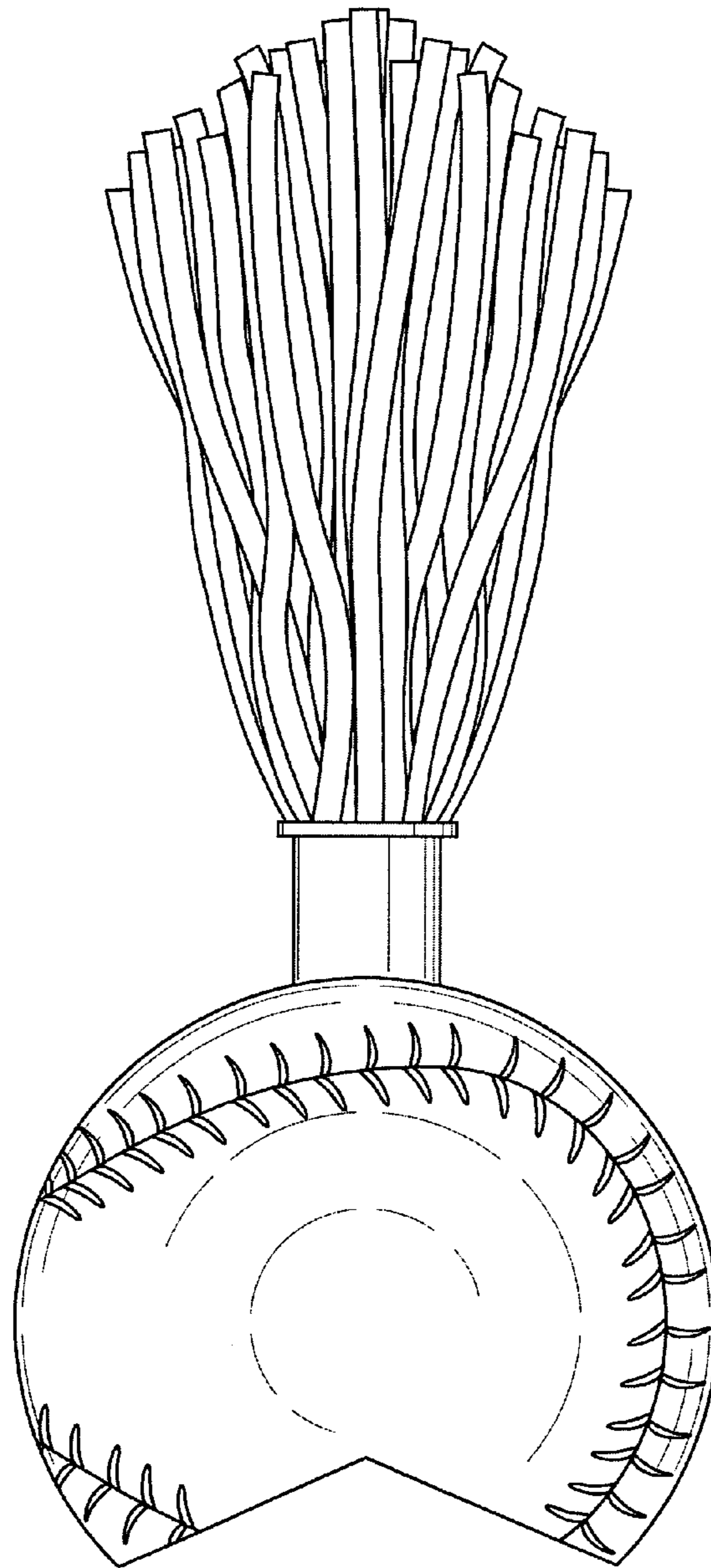

FIG. 13

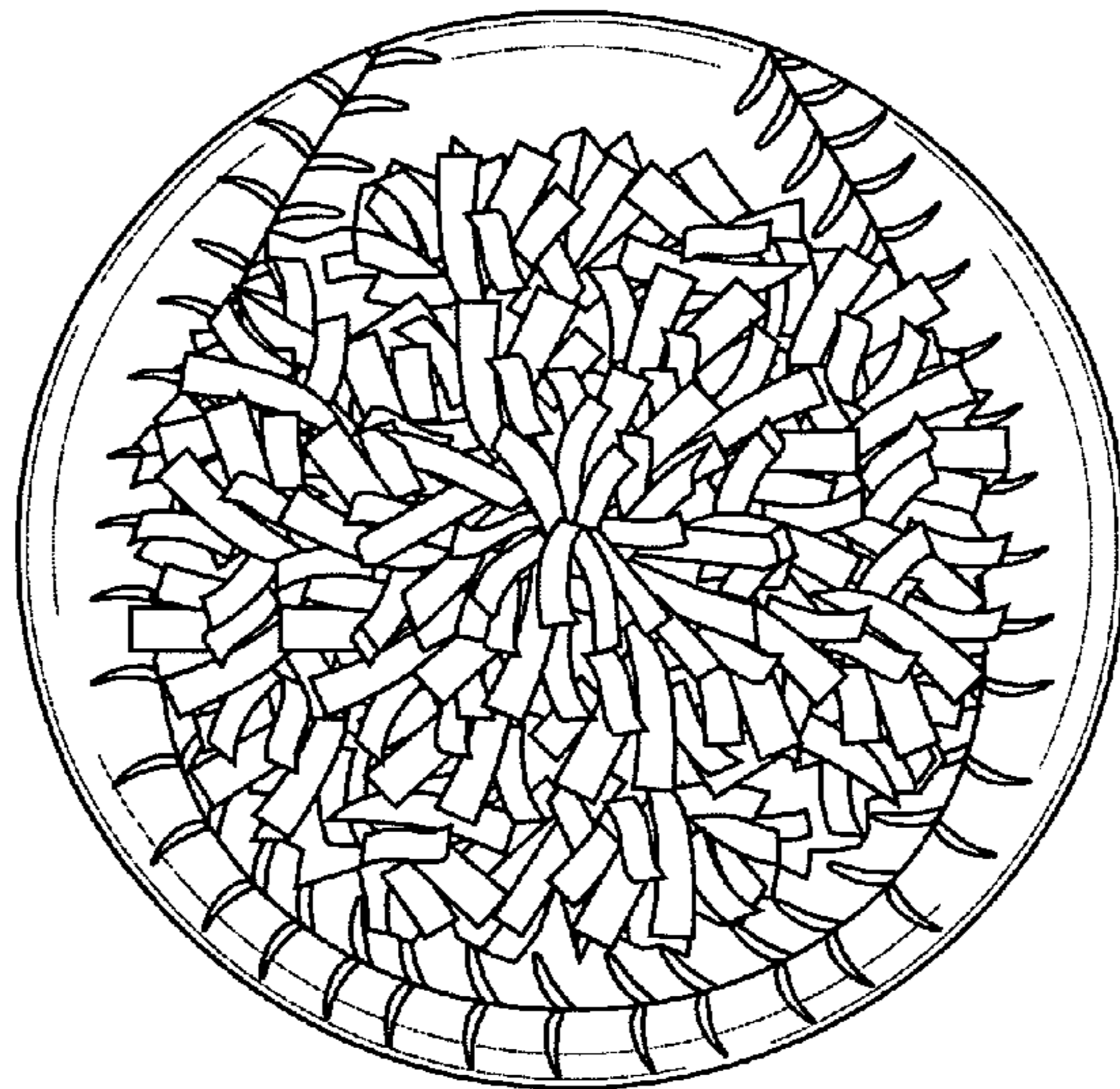

FIG. 14

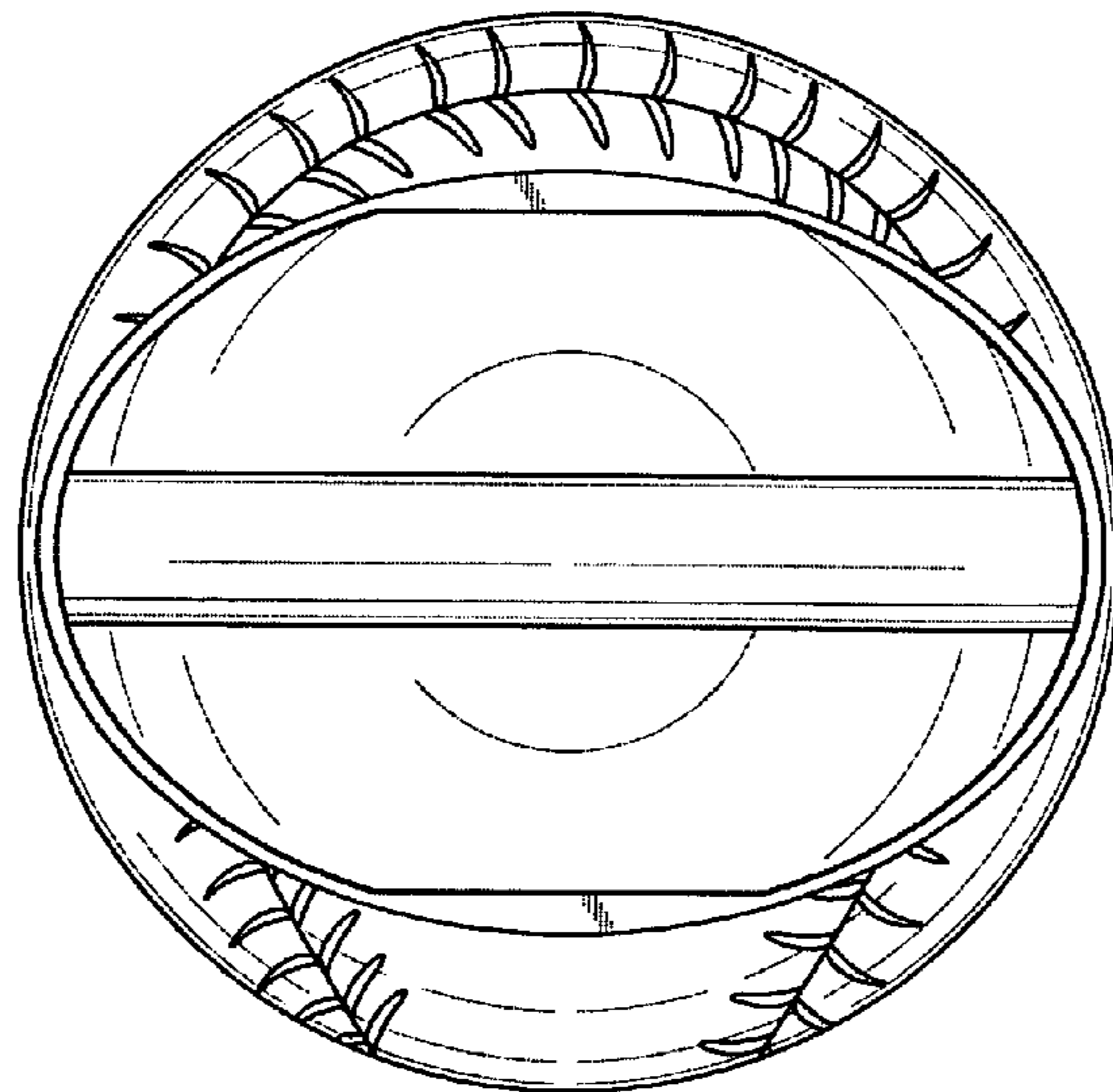
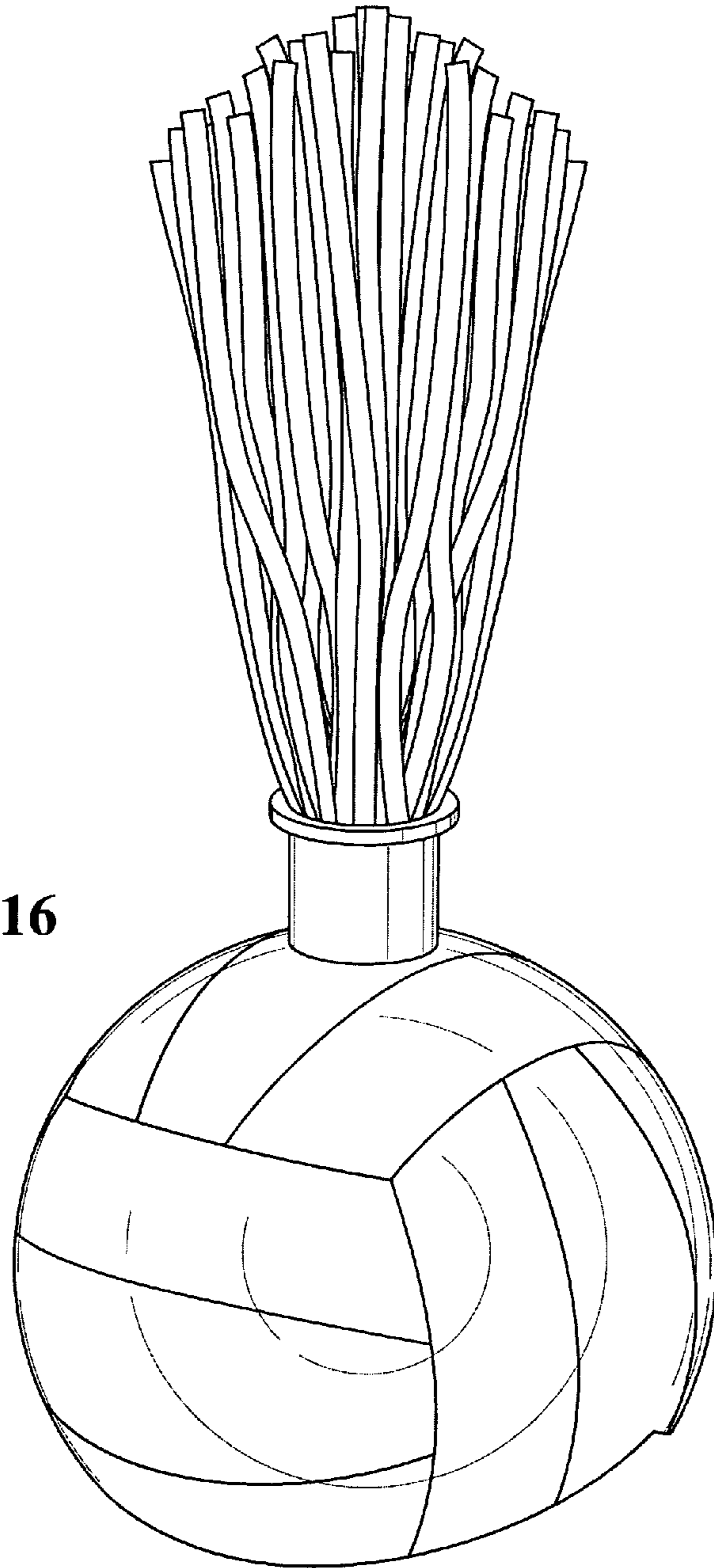

FIG. 15

FIG. 16



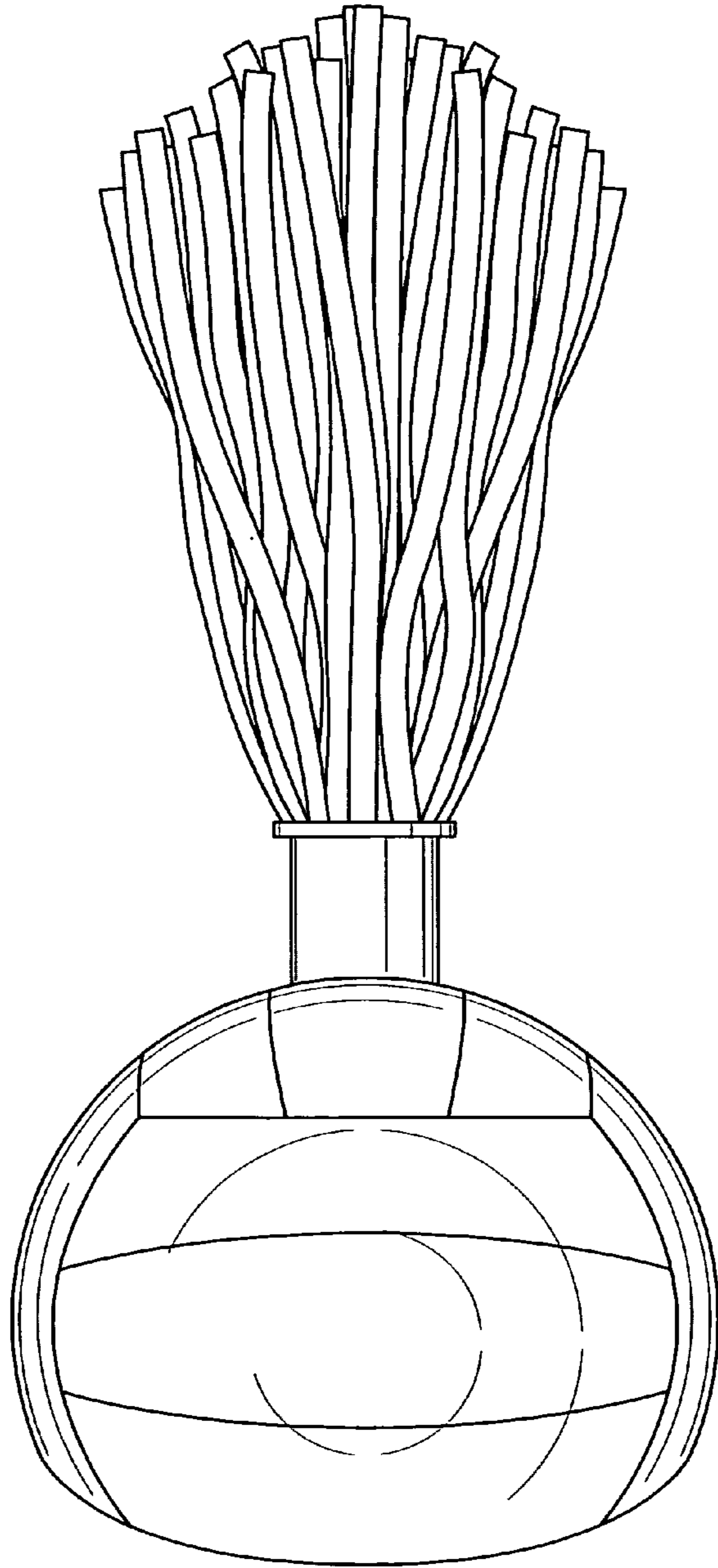

FIG. 17

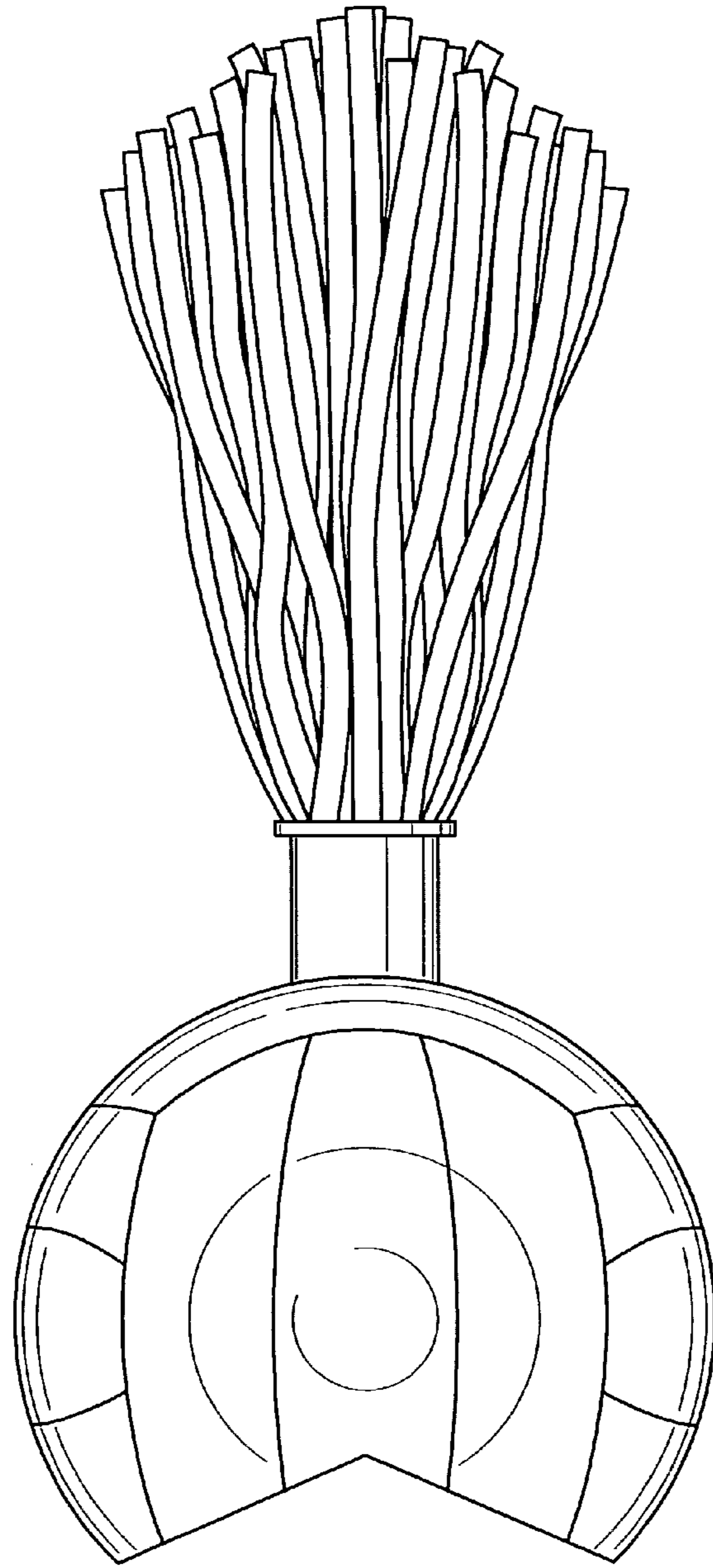

FIG. 18

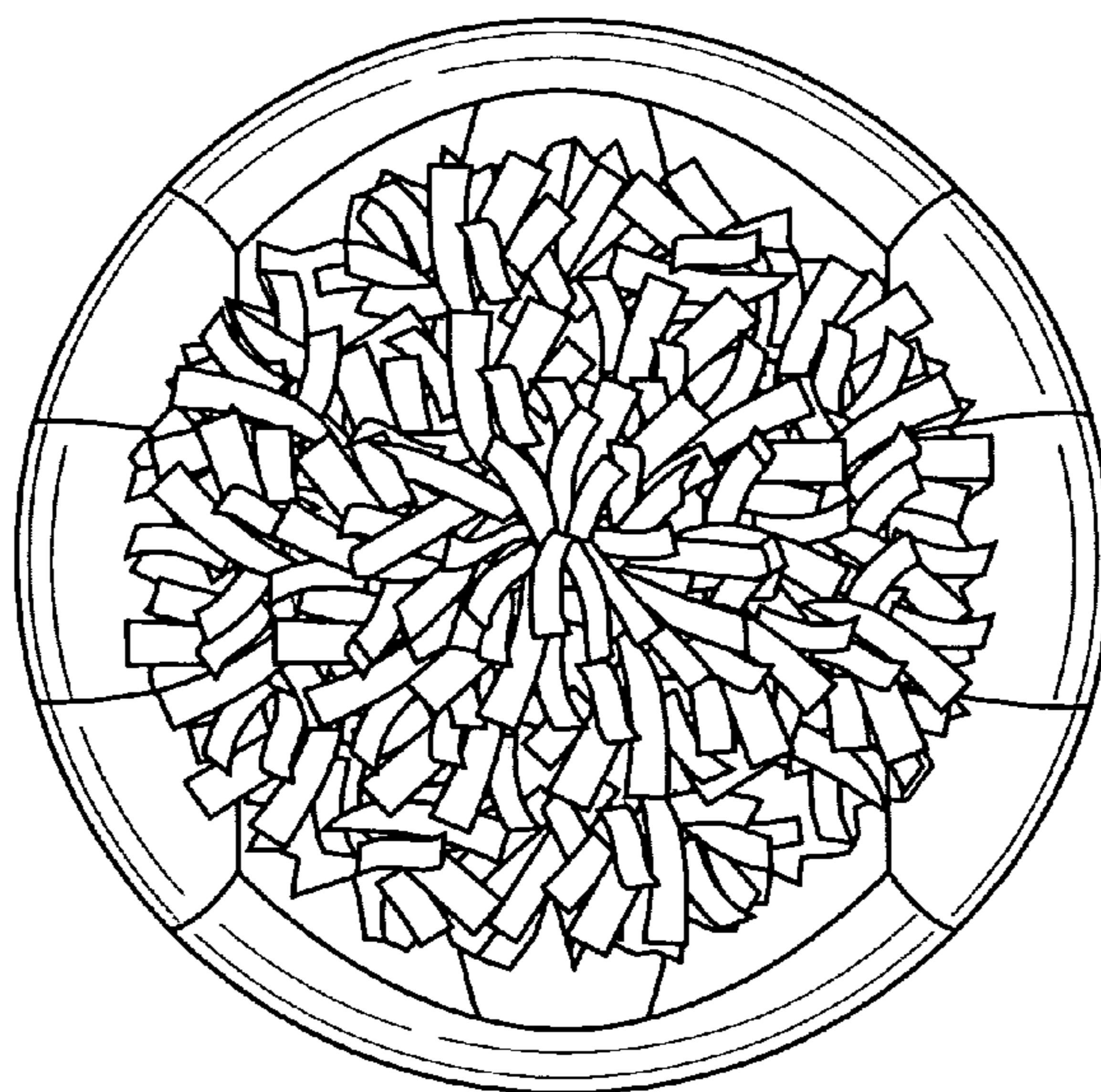

FIG. 19

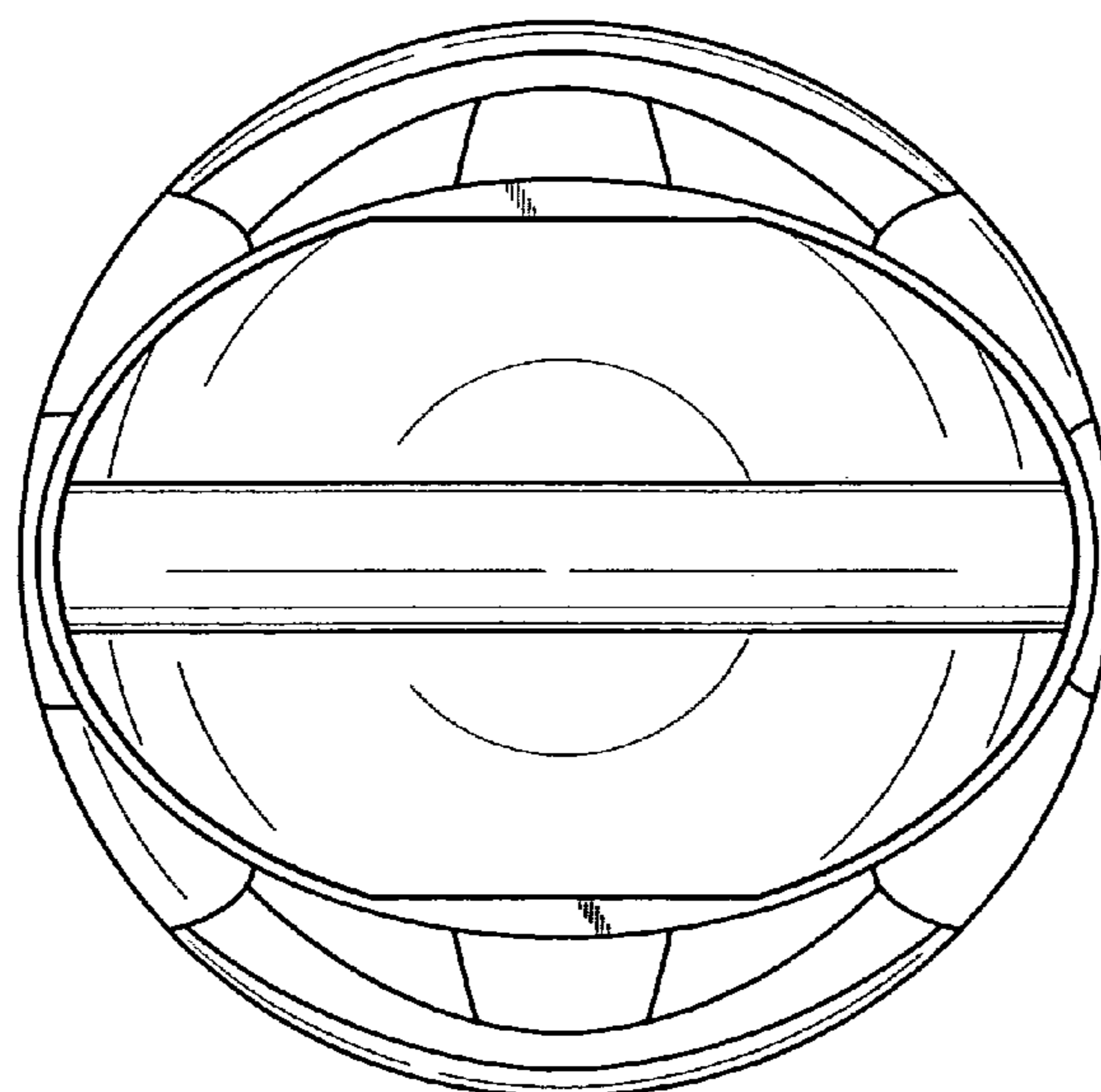

FIG. 20