

US00D673206S

(12) **United States Design Patent**
Abdollahi et al.

(10) **Patent No.:** **US D673,206 S**
(45) **Date of Patent:** **** Dec. 25, 2012**

(54) **GOGGLES**

(75) Inventors: **Hamid Abdollahi**, Vancouver (CA);
Adam Capelin, Vancouver (CA); **Rok Oblak**, Vancouver (CA)

(73) Assignee: **Recon Instruments Inc.**, Vancouver (CA)

(**) Term: **14 Years**

(21) Appl. No.: **29/383,698**

(22) Filed: **Jan. 20, 2011**

(51) **LOC (9) Cl.** **16-06**

(52) **U.S. Cl.** **D16/330; D16/312**

(58) **Field of Classification Search** D16/101,
D16/300-342, 900; D29/109-110; D24/110.2;
351/41, 44, 51-52, 62, 158, 92, 103-123,
351/140, 153, 45-46; 2/426-432, 447-449,
2/441, 434-437, 13, 15; D21/483, 659-661;
D14/372

See application file for complete search history.

(56) **References Cited**

U.S. PATENT DOCUMENTS

D618,270 S * 6/2010 Hooper et al. D16/311
7,841,026 B2 * 11/2010 Makris et al. 2/424
D629,034 S * 12/2010 McNeal et al. D16/312
D629,035 S * 12/2010 Moritz et al. D16/312

OTHER PUBLICATIONS

<http://www.zealoptics.com/2010/generatePage.php?name=eclipse&lens=4&sku=ES2SPP>, 2010.
Zeal Eclipse Goggles—<http://www.zealoptics.com/2010/generatePage.php?name=eclipse&lens=4&sku=ES2SPP>.
Zeal Eclipse Goggles Goolge Search—<http://www.google.ca/search?q=zeal%20eclipse&um=1&ie=UTF-8&tbm=isch&source=og&sa=N&hl=en&tab=wi&biw=1680&bih=949>.

* cited by examiner

Primary Examiner — Raphael Barkai

(74) *Attorney, Agent, or Firm* — Richard A. Johnson;
Borden Ladner Gervais LLP

(57) **CLAIM**

The ornamental design for goggles, as shown and described.

DESCRIPTION

FIG. 1 is a front view of the design;
FIG. 2 is a left side view thereof;
FIG. 3 is a right side view thereof;
FIG. 4 is a top view thereof;
FIG. 5 is a bottom view thereof; and,
FIG. 6 is a back view thereof.

The features shown in broken lines are for illustrative purposes only and form no part of the design as claimed.

1 Claim, 6 Drawing Sheets

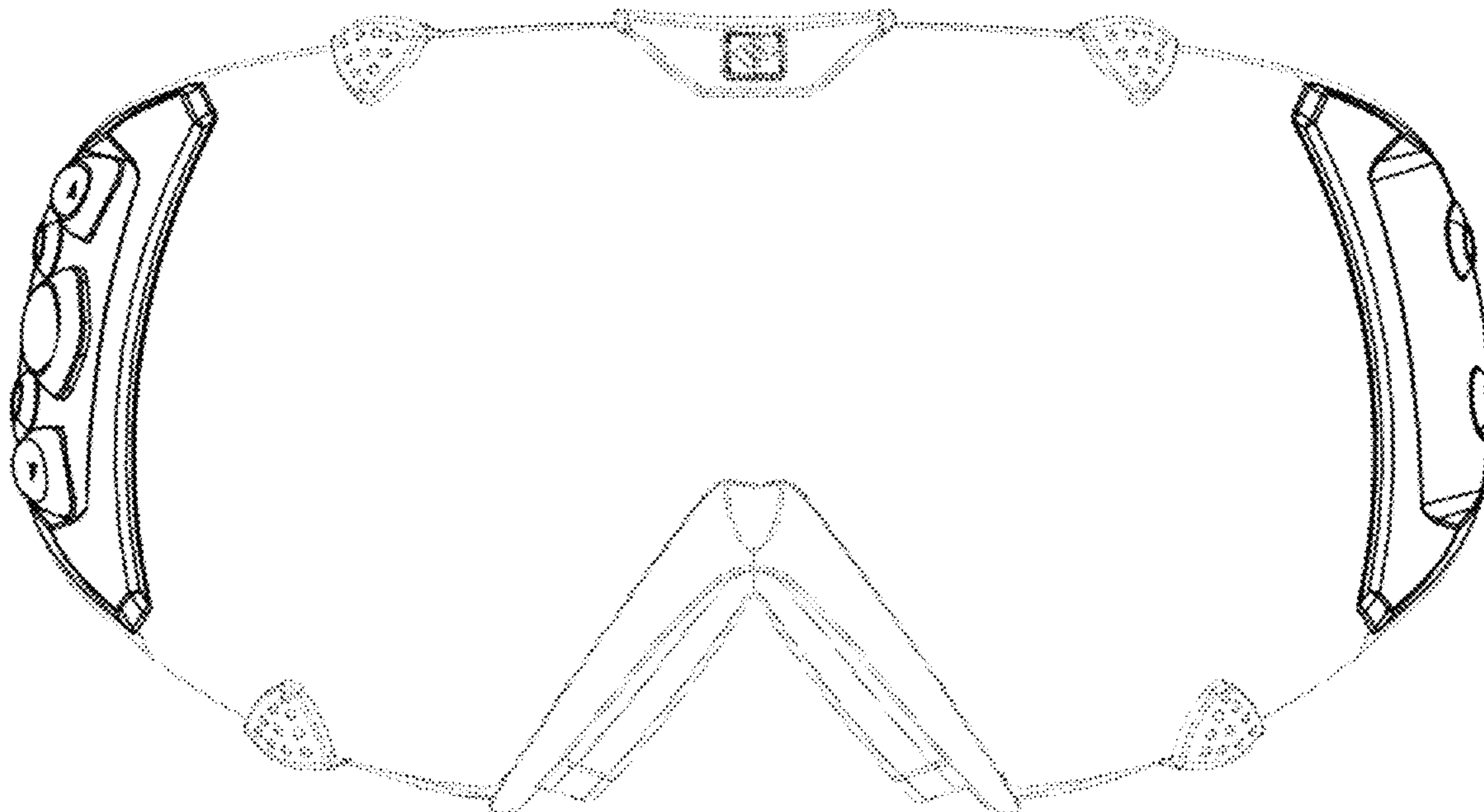

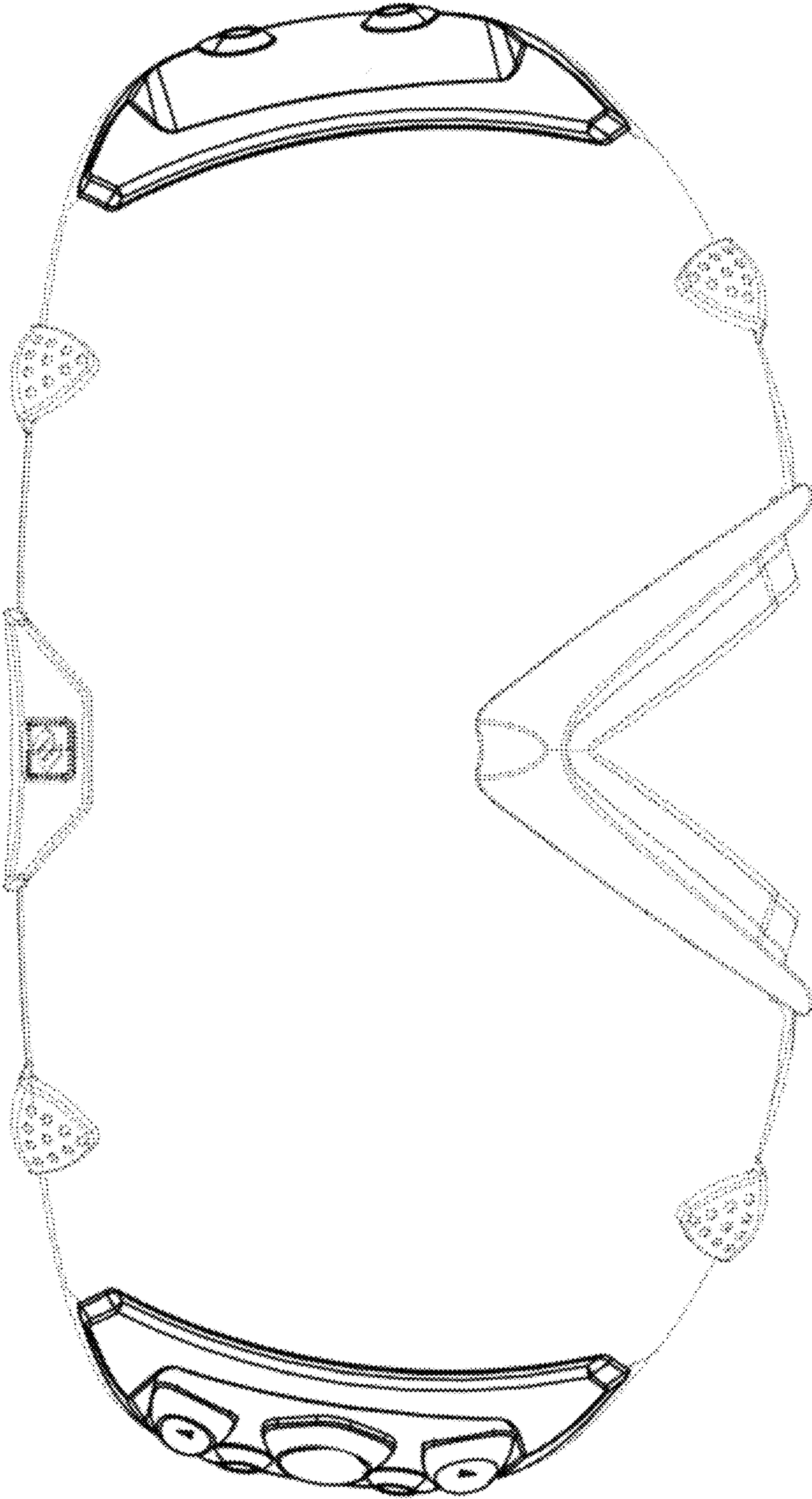

Figure 1

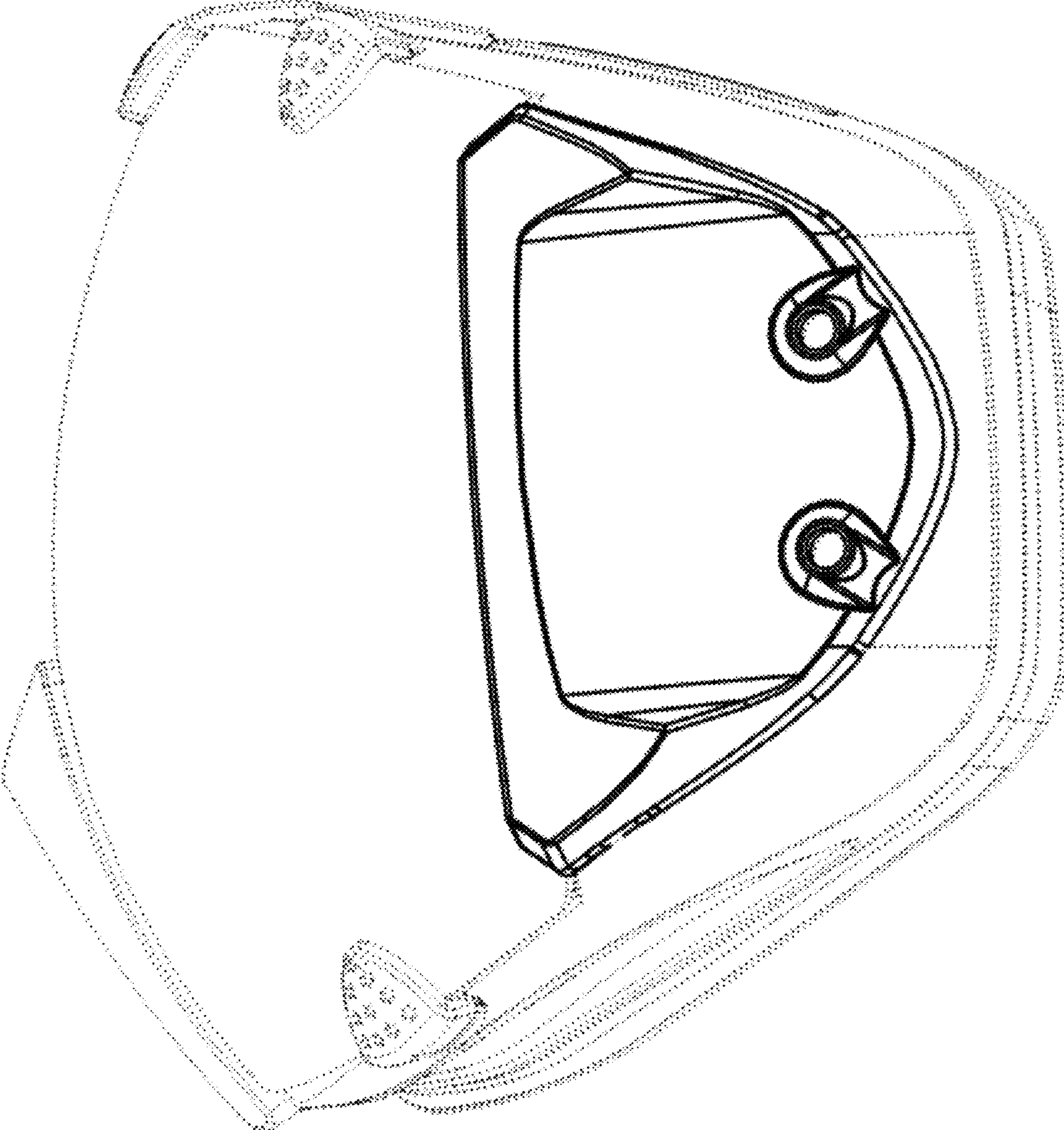

Figure 2

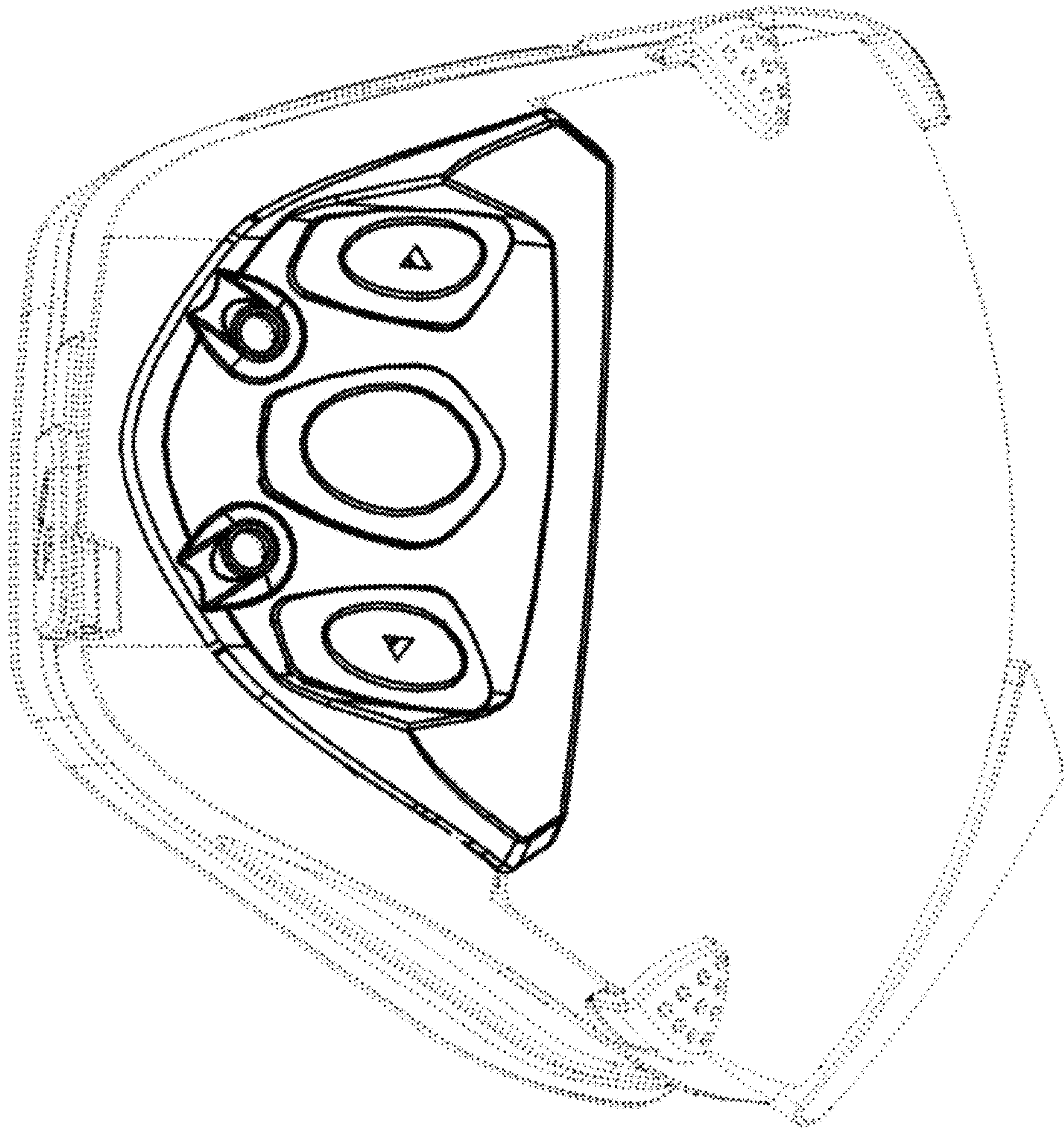

Figure 3

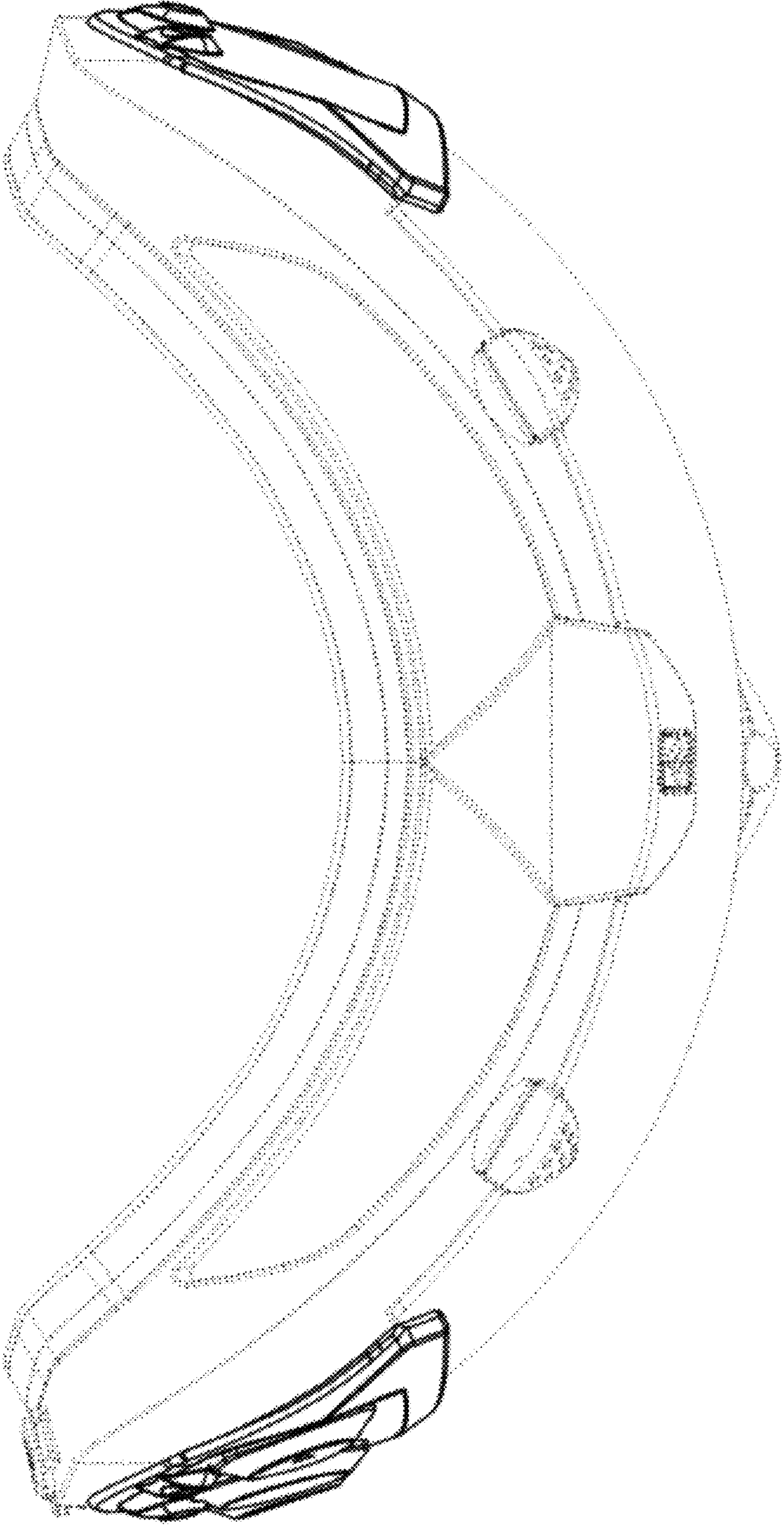

Figure 4

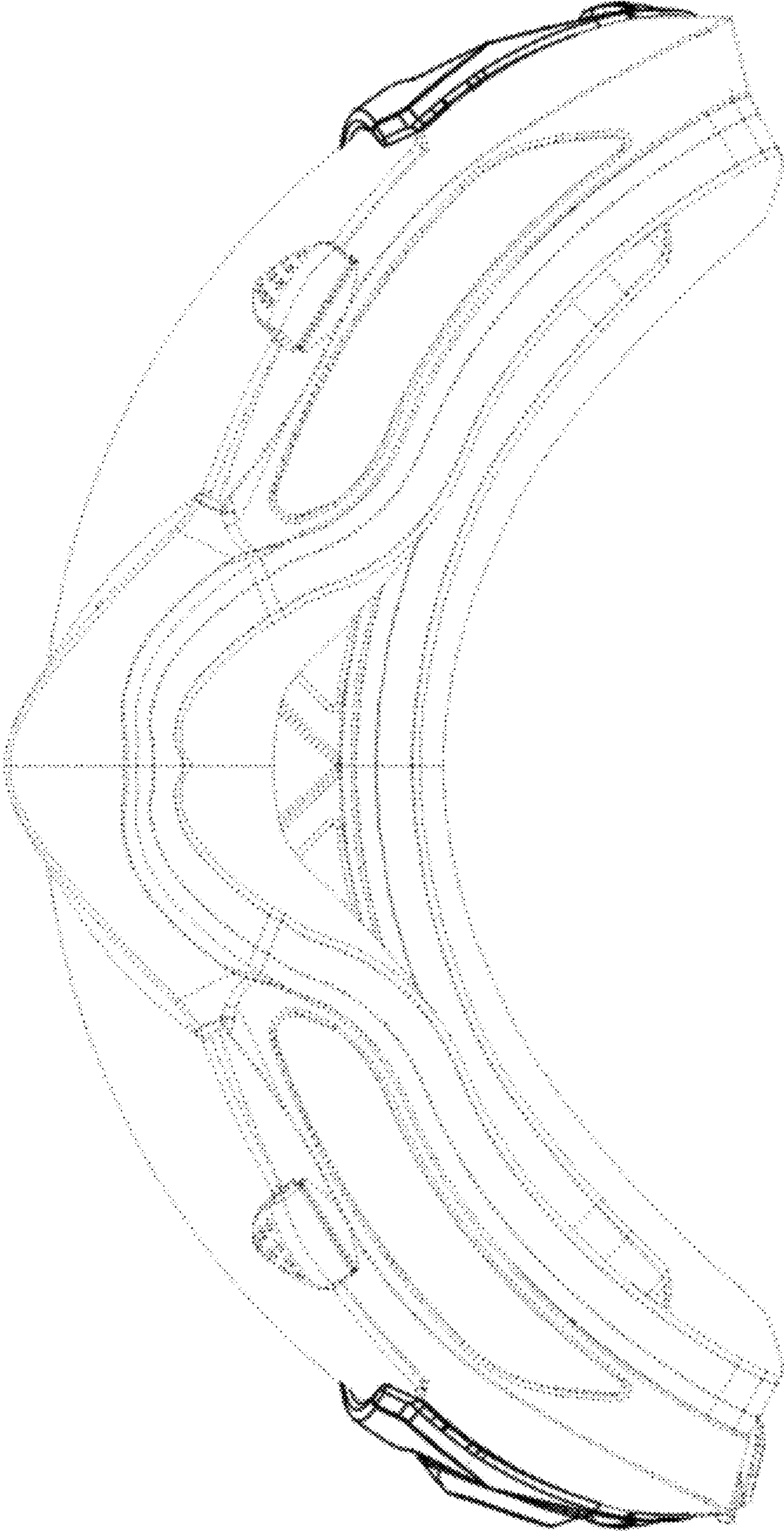

Figure 5

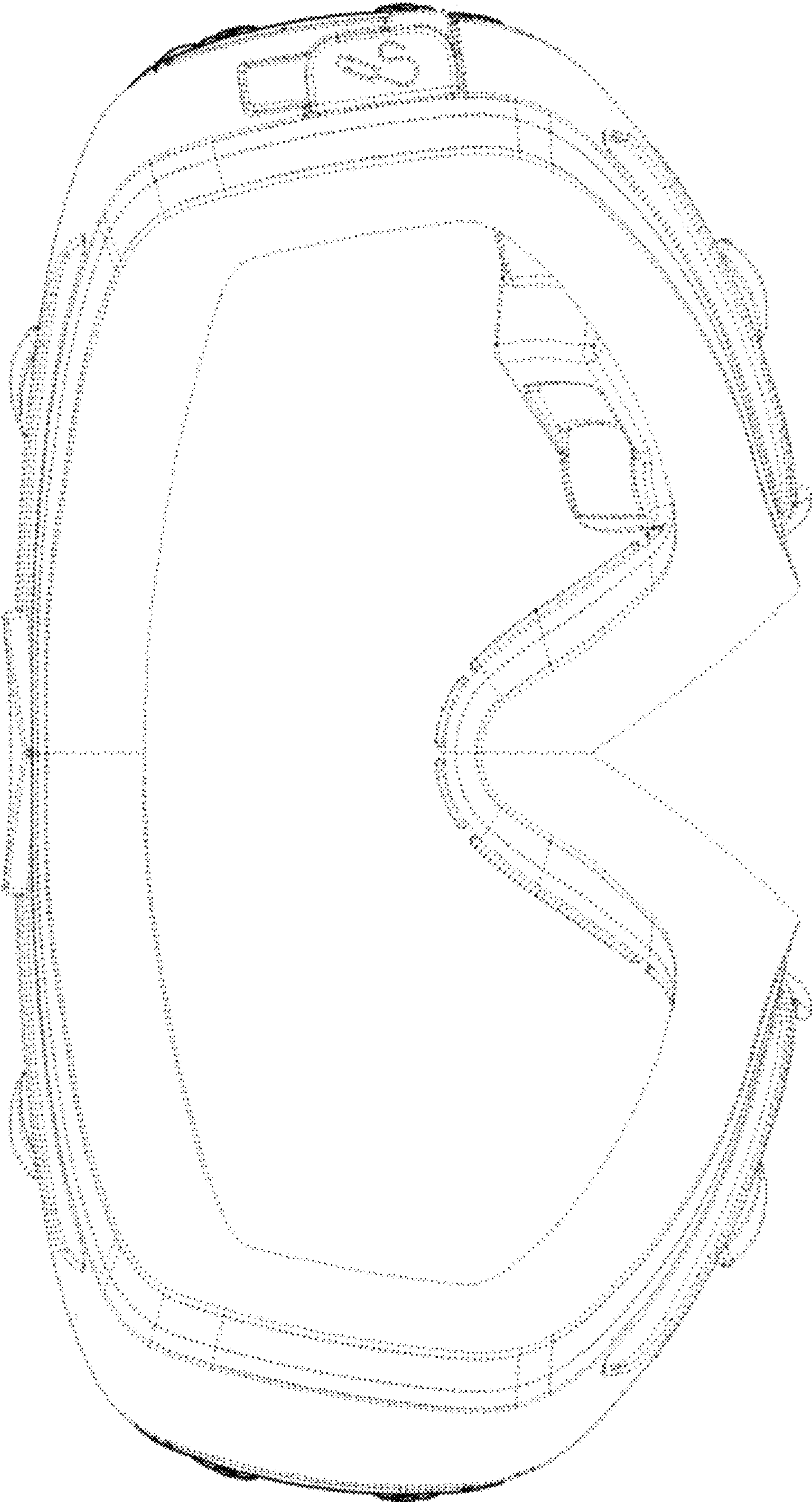

Figure 6