



US00D673182S

(12) **United States Design Patent**
Frazier

(10) **Patent No.:** **US D673,182 S**

(45) **Date of Patent:** **** Dec. 25, 2012**

(54) **LONG RANGE COMPOSITE DOWNHOLE PLUG**

(75) Inventor: **W. Lynn Frazier**, Corpus Christi, TX (US)

(73) Assignee: **Magnum Oil Tools International, Ltd.**, Corpus Christi, TX (US)

(**) Term: **14 Years**

(21) Appl. No.: **29/398,371**

(22) Filed: **Jul. 29, 2011**

(51) **LOC (9) Cl.** **15-03**

(52) **U.S. Cl.** **D15/21**

(58) **Field of Classification Search** D15/21, D15/28; 166/124, 133, 387, 193, 373, 194, 166/317, 318, 376, 123, 134, 135, 378, 102, 166/118, 142, 192; 277/340, 322

See application file for complete search history.

(56) **References Cited**

U.S. PATENT DOCUMENTS

RE17,217 E	2/1929	Burch
2,040,889 A	5/1933	Whinnen
2,223,602 A	10/1938	Cox
2,286,126 A	7/1940	Thornhill
2,376,605 A	5/1945	Lawrence
2,593,520 A	10/1945	Baker et al.
2,616,502 A	3/1948	Lenz
2,756,827 A	6/1948	Farrar
2,714,932 A	8/1951	Thompson
2,737,242 A	8/1952	Baker
2,640,546 A	6/1953	Baker et al.
2,833,354 A	2/1955	Sailers
3,054,453 A	3/1955	Bonner
2,713,910 A	7/1955	Baker et al.
2,830,666 A	7/1956	Rhodes
3,062,296 A	12/1960	Brown
3,082,824 A	3/1963	Taylor et al.
3,013,612 A	12/1964	Angel
3,160,209 A	12/1964	Bonner
3,163,225 A	12/1964	Perkins

3,273,588 A	9/1966	Dollison
3,282,342 A	11/1966	Mott
3,291,218 A	12/1966	Lebourg
3,298,440 A	1/1967	Current
3,308,895 A	3/1967	Oxford et al.
3,356,140 A	12/1967	Young
3,393,743 A	7/1968	Stanescu

(Continued)

FOREIGN PATENT DOCUMENTS

GB 914030 12/1962

(Continued)

OTHER PUBLICATIONS

“Teledyne Merla Oil Tools—Products—Services,” Teledyne Merla, Aug. 1990 (40 pages).

“78/79 Catalog: Packers—Plugs—Completions Tools,” Pengo Industires, Inc., 1978-1979 (12 pages).

“MAP Oil Tools Inc. Catalog,” MAP Oil Tools, Apr. 1999 (46 pages).

“Lovejoy—where the world turns for couplings,” Lovejoy, Inc., Dec. 2000 (30 pages).

(Continued)

Primary Examiner — Mark Goodwin

(74) *Attorney, Agent, or Firm* — Edmonds & Nolte, P.C.

(57) **CLAIM**

The ornamental design for a long range composite downhole plug, as shown and described.

DESCRIPTION

FIG. 1 is a perspective view of a long range composite downhole plug showing my new design;

FIG. 2 is a top plan view thereof;

FIG. 3 is a front side plan view thereof, wherein the front side plan view and the back side plan view are mirror images;

FIG. 4 is a left side plan view thereof;

FIG. 5 is a side plan view of FIG. 4 rotated about 30 degrees;

FIG. 6 is a right side plan view thereof; and,

FIG. 7 is a bottom plan view thereof.

1 Claim, 2 Drawing Sheets

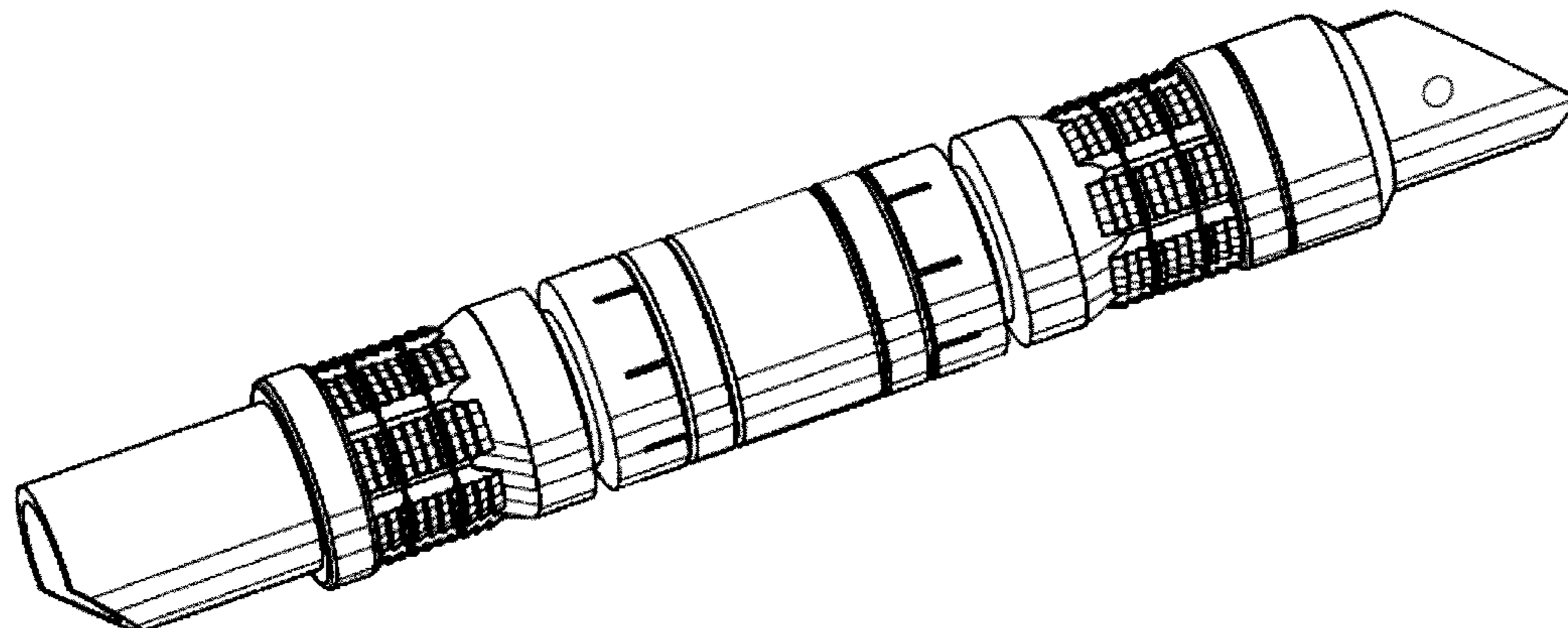

U.S. PATENT DOCUMENTS

3,429,375 A 2/1969 Craig
 3,517,742 A 6/1970 Williams
 3,554,280 A 1/1971 Tucker
 3,687,202 A 8/1972 Young et al.
 3,818,987 A 6/1974 Ellis
 3,851,706 A 12/1974 Ellis
 3,860,066 A 1/1975 Pearce et al.
 3,926,253 A 12/1975 Duke
 4,049,015 A 9/1977 Brown
 4,134,455 A 1/1979 Read
 4,185,689 A 1/1980 Harris
 4,391,547 A 7/1983 Jackson
 4,436,151 A 3/1984 Callihan et al.
 4,437,516 A 3/1984 Cockrell
 4,457,376 A 7/1984 Carmody et al.
 4,493,374 A 1/1985 Magee, Jr.
 4,532,995 A 8/1985 Kaufman
 4,554,981 A 11/1985 Davies
 4,566,541 A 1/1986 Moussy et al.
 4,585,067 A 4/1986 Blizzard et al.
 4,595,052 A 6/1986 Kristiansen
 4,602,654 A 7/1986 Stehling et al.
 4,688,641 A 8/1987 Knieriemen
 4,708,163 A 11/1987 Deaton
 4,708,202 A 11/1987 Sukup et al.
 4,776,410 A 10/1988 Perkin et al.
 4,784,226 A 11/1988 Wyatt
 4,792,000 A 12/1988 Perkin et al.
 4,830,103 A 5/1989 Blackwell et al.
 4,893,678 A 1/1990 Stokley et al.
 5,020,590 A 6/1991 McLeod
 5,095,980 A 3/1992 Watson
 5,113,940 A 5/1992 Glaser
 5,154,228 A 10/1992 Gambertoglio et al.
 5,183,068 A 2/1993 Prosser
 5,188,182 A 2/1993 Echols, III et al.
 5,207,274 A 5/1993 Streich et al.
 5,209,310 A 5/1993 Clydesdale
 5,224,540 A 7/1993 Streich et al.
 5,230,390 A 7/1993 Zastressek et al.
 5,234,052 A 8/1993 Coone et al.
 5,253,705 A 10/1993 Clary et al.
 5,311,939 A 5/1994 Pringle et al.
 5,316,081 A 5/1994 Baski et al.
 5,343,954 A 9/1994 Bohlen et al.
 5,419,399 A 5/1995 Smith
 5,564,502 A 10/1996 Crow et al.
 5,593,292 A 1/1997 Ivey et al.
 5,803,173 A 9/1998 Fraser, III et al.
 5,810,083 A 9/1998 Kilgore
 5,984,007 A * 11/1999 Yuan et al. 166/134
 6,012,519 A 1/2000 Allen et al.
 6,098,716 A 8/2000 Hromas et al.
 6,142,226 A 11/2000 Vick
 6,152,232 A 11/2000 Webb et al.
 6,167,963 B1 1/2001 McMahan
 6,182,752 B1 2/2001 Smith, Jr. et al.
 6,199,636 B1 3/2001 Harrison
 6,283,148 B1 9/2001 Spears et al.
 6,394,180 B1 * 5/2002 Berscheidt et al. 166/193
 6,491,108 B1 12/2002 Slup
 6,629,563 B2 10/2003 Doane
 6,695,049 B2 2/2004 Ostocke et al.
 6,708,770 B2 3/2004 Slup et al.
 6,725,935 B2 4/2004 Szarka et al.
 6,769,491 B2 8/2004 Zimmerman et al.
 6,796,376 B2 9/2004 Frazier
 6,799,633 B2 10/2004 McGregor
 6,834,717 B2 12/2004 Bland
 6,851,489 B2 2/2005 Hinds
 6,902,006 B2 6/2005 Myerley et al.
 6,918,439 B2 7/2005 Dallas
 6,938,696 B2 9/2005 Dallas
 7,021,389 B2 4/2006 Bishop et al.
 7,040,410 B2 5/2006 McGuire et al.
 7,055,632 B2 6/2006 Dallas
 7,069,997 B2 7/2006 Coyes et al.

7,107,875 B2 9/2006 Haugen et al.
 7,124,831 B2 * 10/2006 Turley et al. 166/387
 7,128,091 B2 10/2006 Istre, Jr.
 7,281,584 B2 10/2007 McGarian et al.
 7,337,847 B2 3/2008 McGarian et al.
 7,350,582 B2 4/2008 McKeachnie et al.
 7,527,104 B2 5/2009 Branch et al.
 7,552,779 B2 6/2009 Murray
 7,604,058 B2 10/2009 McGuire
 7,637,326 B2 12/2009 Bolding et al.
 7,644,767 B2 1/2010 Kalb et al.
 7,644,774 B2 1/2010 Branch et al.
 7,673,677 B2 3/2010 King et al.
 7,740,079 B2 6/2010 Clayton et al.
 7,775,286 B2 8/2010 Duphorne
 7,775,291 B2 8/2010 Jacob
 7,784,550 B2 8/2010 Nutley et al.
 7,810,558 B2 10/2010 Shkurti et al.
 7,866,396 B2 1/2011 Rytlewski
 7,878,242 B2 2/2011 Gray
 7,886,830 B2 2/2011 Bolding et al.
 7,900,696 B1 * 3/2011 Nish et al. 166/133
 7,909,108 B2 3/2011 Swor et al.
 7,909,109 B2 3/2011 Angman et al.
 7,918,278 B2 4/2011 Barbee
 7,921,923 B2 4/2011 McGuire
 7,921,925 B2 4/2011 Maguire et al.
 7,926,571 B2 4/2011 Hofman
 8,079,413 B2 * 12/2011 Frazier 166/124
 2003/0024706 A1 2/2003 Allamon
 2003/0188860 A1 10/2003 Zimmerman et al.
 2006/0278405 A1 * 12/2006 Turley et al. 166/385
 2007/0051521 A1 3/2007 Fike et al.
 2007/0107908 A1 5/2007 Vaidya et al.
 2008/0060821 A1 3/2008 Smith et al.
 2008/0110635 A1 5/2008 Loretz et al.
 2009/0211749 A1 8/2009 Nguyen et al.
 2010/0084146 A1 4/2010 Roberts
 2010/0132960 A1 6/2010 Shkurti et al.
 2010/0155050 A1 6/2010 Frazier
 2010/0252252 A1 10/2010 Harris et al.
 2010/0263876 A1 10/2010 Frazier
 2010/0276159 A1 11/2010 Mailand et al.
 2010/0288503 A1 11/2010 Cuiper et al.
 2011/0036564 A1 2/2011 Williamson
 2011/0061856 A1 3/2011 Kellner et al.
 2011/0088915 A1 4/2011 Stanojcic et al.
 2011/0103915 A1 5/2011 Tedeshi

FOREIGN PATENT DOCUMENTS

WO WO2010127457 11/2010

OTHER PUBLICATIONS

“Halliburton Services, Sales & Service Catalog,” Halliburton Services, 1970-1971 (2 pages).
 “1975-1976 Packer Catalog,” Gearhart-Owen Industries Inc., 1975-1976 (52 pages).
 “Formation Damage Control Utilizing Composite-Bridge Plug Technology for Monobore, Multizone Stimulation Operations,” Gary Garfield, SPE, May 15, 2001 (8 pages).
 “Composite Bridge Plug Technique for Multizone Commingled Gas Wells,” Gary Garfield, SPE, Mar. 24, 2001 (6 pages).
 “Composite Research: Composite bridge plugs used in multi-zone wells to avoid costly kill-weight fluids,” Gary Garfield, SPE, Mar. 24, 2001 (4 pages).
 “It’s About Time—Quick Drill Composite Bridge Plug,” Baker Oil Tools, Jun. 2002 (2 pages).
 “Baker Hughes—Baker Oil Tools—Workover Systems—QUICK Drill Composite Bride Plug,” Baker Oil Tools, Dec. 2000 (3 pages).
 “Baker Hughes 100 Years of Service,” Baker Hushes In Depth, Special Centennial Issue, Publication COR-07-13127, vol. 13, No. 2, Baker Hughes Incorporated, Jul. 2007 (92 pages).
 “Halliburton Services, Sales & Service Catalog No. 43,” Halliburton Co., 1985 (202 pages).
 “Alpha Oil Tools Catalog,” Alpha Oil Tools, 1997 (136 pages).

* cited by examiner

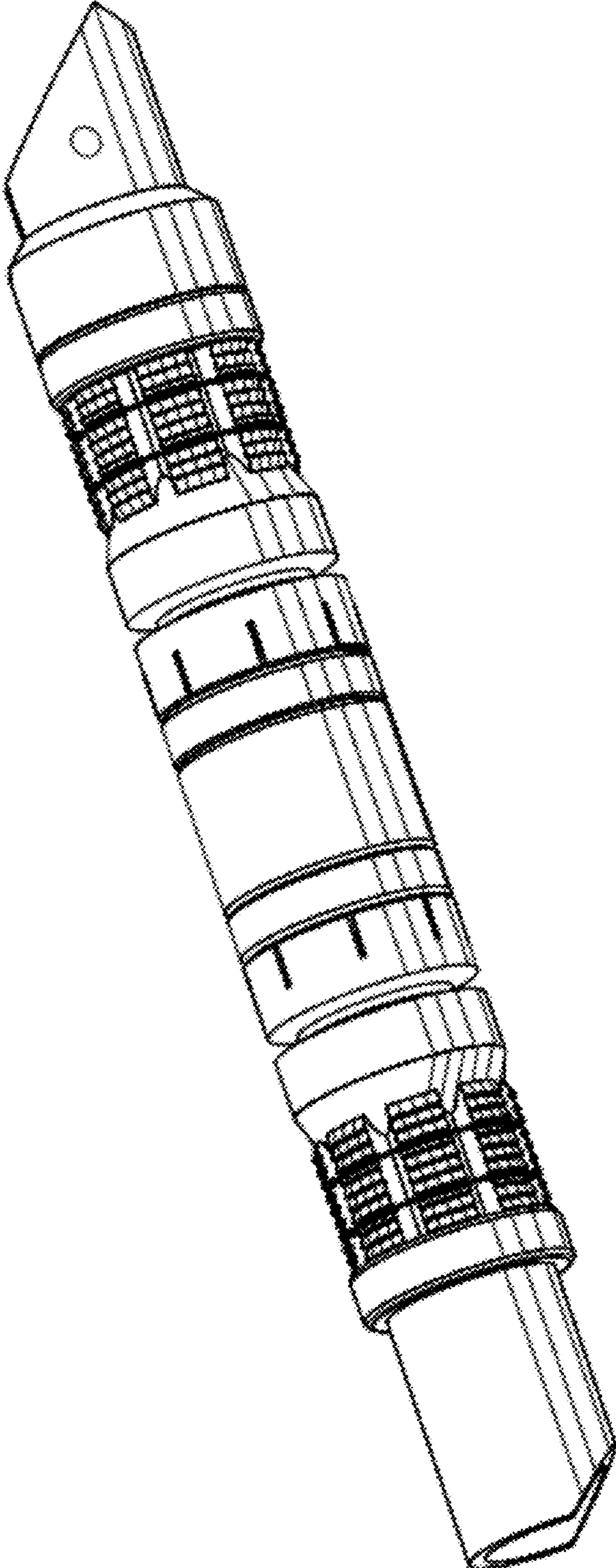

FIG. 1

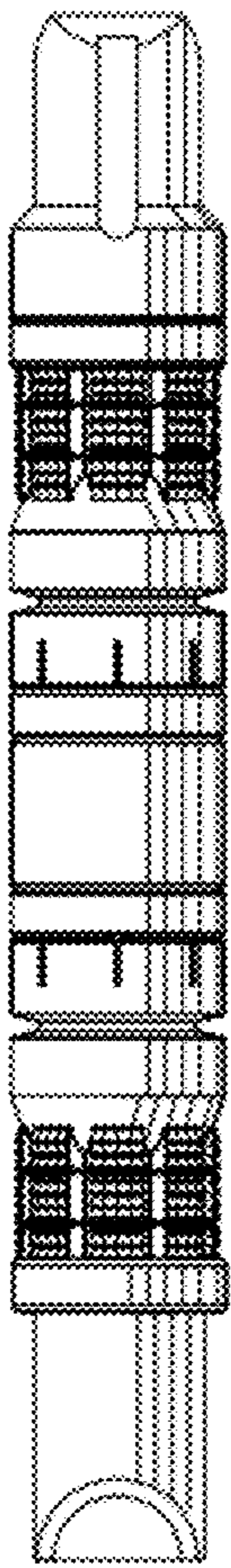

FIG. 6

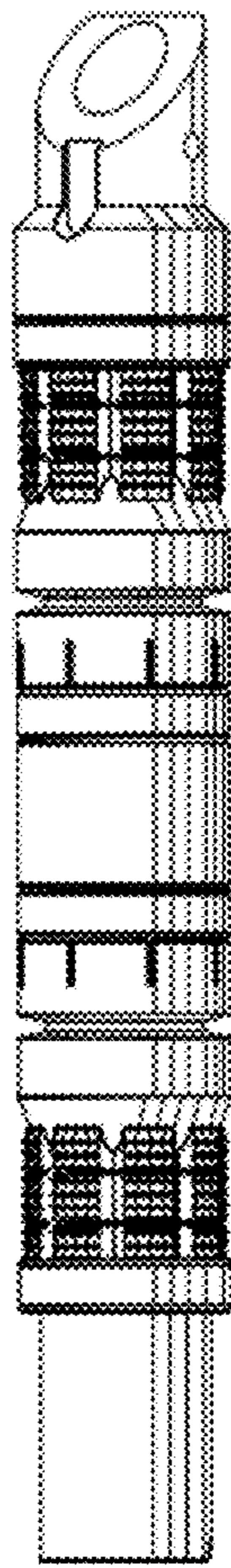

FIG. 5

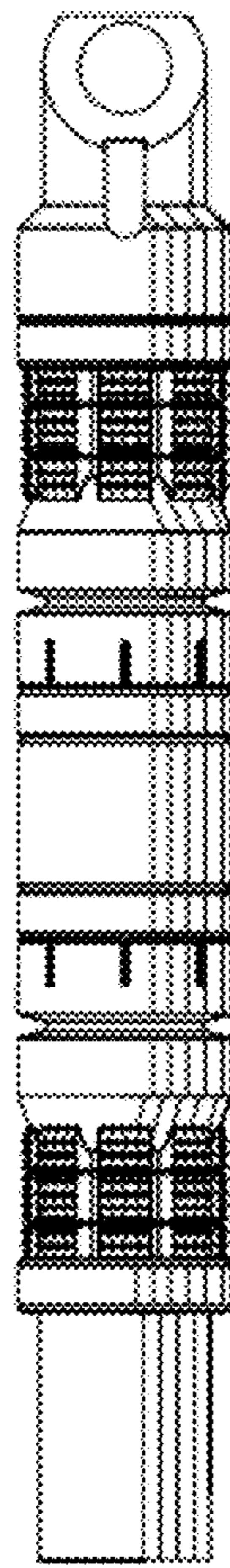

FIG. 4

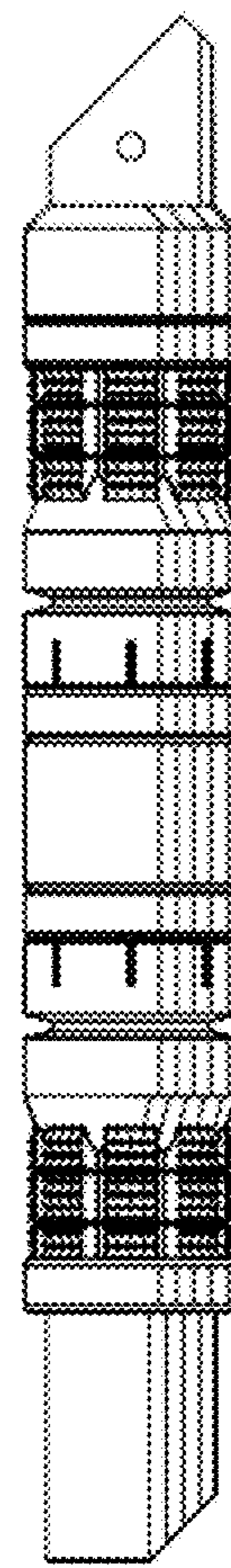

FIG. 3

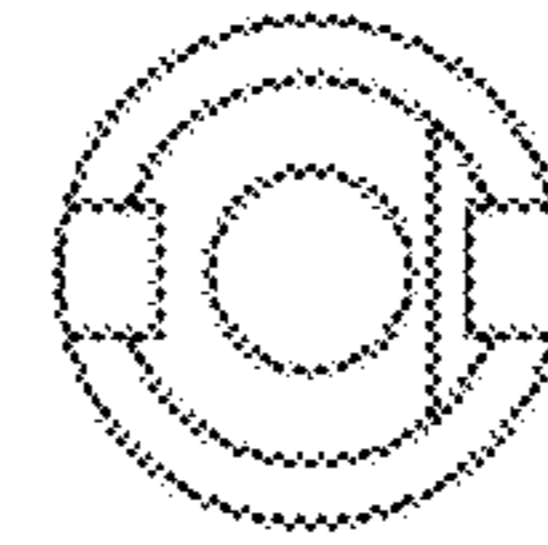

FIG. 7

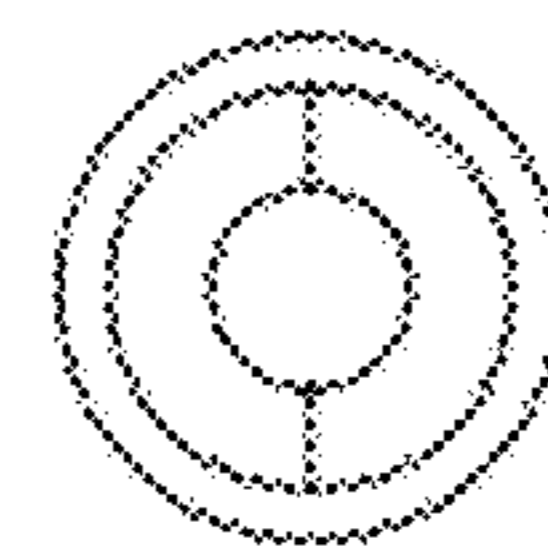

FIG. 2