



US00D673152S

(12) **United States Design Patent**
Bousfield et al.

(10) **Patent No.:** **US D673,152 S**
(45) **Date of Patent:** **** Dec. 25, 2012**

(54) **ACCESS CONTROL READER**

(75) Inventors: **Randall Dennis Bousfield**, Arvada, CO (US); **David Edward Andresky**, Lafayette, CO (US); **Toby Mark Padilla**, Lakewood, CO (US); **Robert J. Price**, Denver, CO (US); **Damon Dageenakis**, Erie, CO (US); **David William Adams**, Minneapolis, MN (US)

(73) Assignee: **Assa Abloy AB (SE)**

(**) Term: **14 Years**

(21) Appl. No.: **29/417,505**

(22) Filed: **Apr. 4, 2012**

(51) **LOC (9) Cl.** **14-02**

(52) **U.S. Cl.** **D14/385**

(58) **Field of Classification Search** D24/232,
D24/216, 186, 169, 107; D14/496, 432,
D14/420, 385, 384, 383; D13/108; D10/104.1;
726/9; 422/82.01; 382/124; 235/375

See application file for complete search history.

(56) **References Cited**

U.S. PATENT DOCUMENTS

D264,194 S	5/1982	Jaretsky	
D278,054 S *	3/1985	Vajdaffy	D14/159
4,788,420 A	11/1988	Chang et al.	
D298,944 S	12/1988	Stark et al.	
D303,137 S	8/1989	Brown	
D309,297 S *	7/1990	Suda	D18/4.6
D310,791 S	9/1990	Farrell et al.	
D327,856 S	7/1992	Loew et al.	
D328,260 S	7/1992	Loew et al.	
D338,876 S	8/1993	Nair et al.	
D340,919 S	11/1993	Lee	
5,425,080 A	6/1995	Abbie	
5,426,286 A	6/1995	Nair et al.	
D361,129 S *	8/1995	Collins et al.	D24/169
D367,044 S	2/1996	Arakaki	
D368,892 S	4/1996	Tanaka	
D382,862 S	8/1997	Nakayama et al.	
D389,466 S *	1/1998	Nakao et al.	D14/387

D389,762 S	1/1998	Yorkey	
D389,817 S *	1/1998	Umetsu	D14/384
D390,543 S	2/1998	Hower et al.	
D390,837 S	2/1998	Hower et al.	
5,786,587 A	7/1998	Colgate	
D397,682 S	9/1998	Yotukura	
D400,191 S	10/1998	Butts et al.	
5,825,617 A	10/1998	Kochis et al.	
5,850,217 A	12/1998	Cole	
D409,650 S	5/1999	Hanna et al.	
5,933,812 A	8/1999	Meyer et al.	
D425,873 S	5/2000	Anderson et al.	

(Continued)

OTHER PUBLICATIONS

U.S. Appl. No. 29/340,650, filed Jul. 22, 2009, Padilla et al.

(Continued)

Primary Examiner — Austin Murphy

(74) *Attorney, Agent, or Firm* — Sheridan Ross P.C.

(57) **CLAIM**

The ornamental design for an access control reader, as shown and described.

DESCRIPTION

A portion of the disclosure of this patent document contains material to which a claim for copyright is made. The copyright owner has no objection to the facsimile reproduction by anyone of the patent document or the patent disclosure, as it appears in the Patent and Trademark Office patent file or records, but reserves all other copyright rights whatsoever.

FIG. 1 is a perspective view of an access control reader;

FIG. 2 is a top elevational view thereof;

FIG. 3 is a front plan view thereof;

FIG. 4 is a left side elevational view thereof;

FIG. 5 is a right side elevational view thereof;

FIG. 6 is a back plan view thereof; and,

FIG. 7 is a bottom elevational view thereof.

The broken lines shown in the drawings represent portions of the access control reader that form no part of the claimed design.

1 Claim, 4 Drawing Sheets

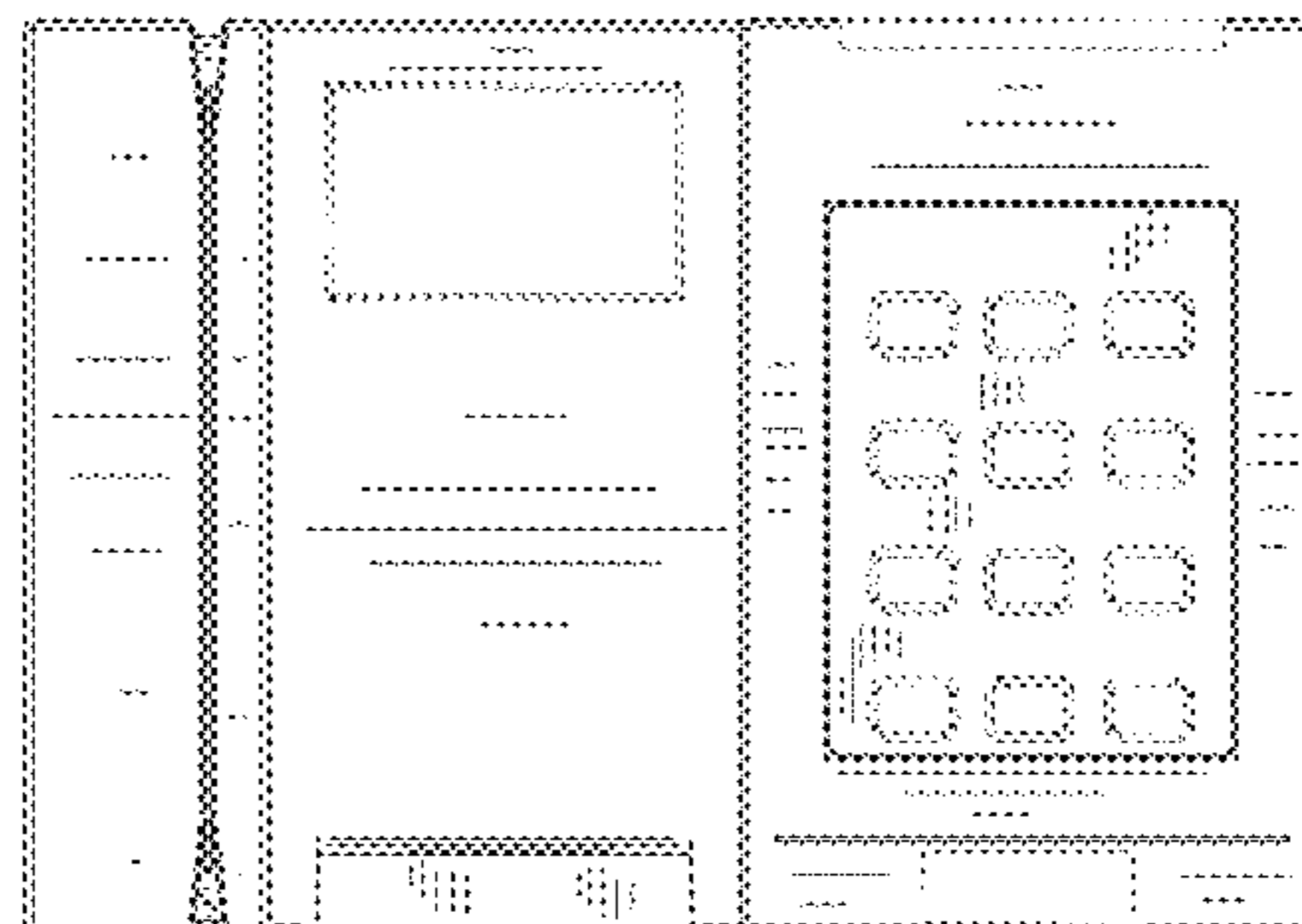
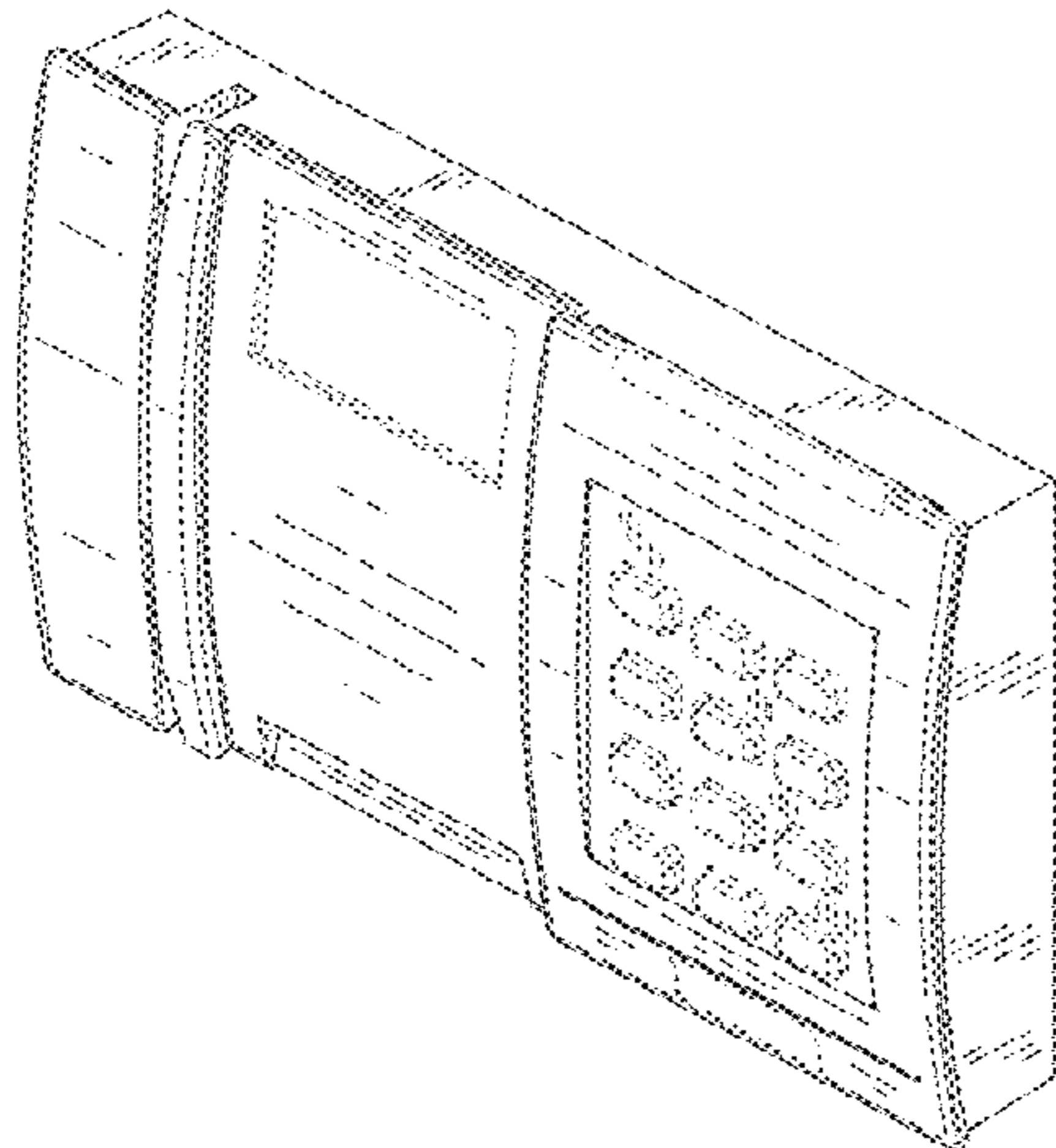

U.S. PATENT DOCUMENTS

D428,046	S	7/2000	Berger	
6,097,606	A	8/2000	Groves et al.	
6,111,977	A	* 8/2000	Scott et al.	382/124
D454,876	S	3/2002	Lum et al.	
D454,879	S	3/2002	Lin et al.	
D459,670	S	7/2002	Bergstrom	
D462,680	S	* 9/2002	Hartwig	D14/387
6,445,572	B1	9/2002	Chou	
D467,349	S	12/2002	Niedbala et al.	
6,509,876	B1	1/2003	Jones et al.	
D480,725	S	10/2003	Funato	
D500,038	S	12/2004	Toratani et al.	
D501,208	S	1/2005	Ozolins et al.	
D501,664	S	2/2005	Minamio et al.	
D508,245	S	8/2005	Ozolins et al.	
D511,113	S	11/2005	Feldman et al.	
6,963,266	B2	11/2005	Palomaki et al.	
D515,707	S	2/2006	Shinohara et al.	
D516,068	S	2/2006	Walter	
D516,069	S	* 2/2006	Kuroda et al.	D14/384
D518,050	S	3/2006	Wood et al.	
D520,488	S	* 5/2006	Fabrizi	D14/159
D542,291	S	5/2007	Kang et al.	
7,284,266	B1	10/2007	Morris et al.	
D563,806	S	3/2008	Jeon	
D564,014	S	3/2008	Spence et al.	
D574,850	S	8/2008	Zimman et al.	
D577,623	S	9/2008	Ta et al.	
D583,812	S	12/2008	Asibey	
D589,832	S	4/2009	Ogura et al.	
D596,977	S	7/2009	Ogura et al.	
D599,189	S	9/2009	Nunez et al.	
D601,259	S	* 9/2009	Guthrie et al.	D24/169
D602,021	S	* 10/2009	Noda et al.	D14/383
D620,380	S	7/2010	Hwang	
RE41,716	E	9/2010	Fernando et al.	
D649,548	S	11/2011	Szoke et al.	
2009/0215317	A1	8/2009	Idzik et al.	
2010/0195279	A1	8/2010	Michael	
2011/0226849	A1	9/2011	Padilla et al.	

OTHER PUBLICATIONS

U.S. Appl. No. 29/417,499, filed Apr. 4, 2012, Bousfield et al.
 U.S. Appl. No. 29/417,500, filed Apr. 4, 2012, Bousfield et al.
 U.S. Appl. No. 29/417,501, filed Apr. 4, 2012, Bousfield et al.
 U.S. Appl. No. 29/417,502, filed Apr. 4, 2012, Bousfield et al.
 U.S. Appl. No. 29/417,503, filed Apr. 4, 2012, Bousfield et al.
 U.S. Appl. No. 29/417,506, filed Apr. 4, 2012, Bousfield et al.
 U.S. Appl. No. 29/417,507, filed Apr. 4, 2012, Bousfield et al.
 Notice of Allowance with English translation for China Patent Application No. 201230095148.X, dated Jun. 18, 2012 5 pages.
 Notice of Allowance with English translation for China Patent Application No. 201230094363.8, dated Jun. 20, 2012 5 pages.
 Notice of Allowance with English translation for China Patent Application No. 201230095188.4, dated Jun. 20, 2012 5 pages.
 Notice of Allowance with English translation for China Patent Application No. 201230095190.1, dated Jun. 21, 2012 5 pages.
 Notice of Allowance with English translation for China Patent Application No. 201230094577.5, dated Jul. 17, 2012 5 pages.
 Notice of Allowance with English translation for China Patent Application No. 201230095097.0, dated Aug. 17, 2012 5 pages.
 Notice of Allowance with English translation for China Patent Application No. 201230094244.2, dated Aug. 27, 2012 5 pages.
 Notice of Allowance for U.S. Appl. No. 29/417,500, mailed Jul. 30, 2012 8 pages.
 Notice of Allowance for U.S. Appl. No. 29/417,501, mailed Jul. 30, 2012 8 pages.
 Notice of Allowance for U.S. Appl. No. 29/417,502, mailed Jul. 30, 2012 7 pages.
 Notice of Allowance for U.S. Appl. No. 29/417,506, mailed Jul. 31, 2012 7 pages.
 Notice of Allowance for U.S. Appl. No. 29/417,499, mailed Aug. 2, 2012 8 pages.
 Notice of Allowance for U.S. Appl. No. 29/417,507, mailed Aug. 6, 2012 8 pages.
 Notice of Allowance for U.S. Appl. No. 29/417,503, mailed Aug. 9, 2012 8 pages.

* cited by examiner

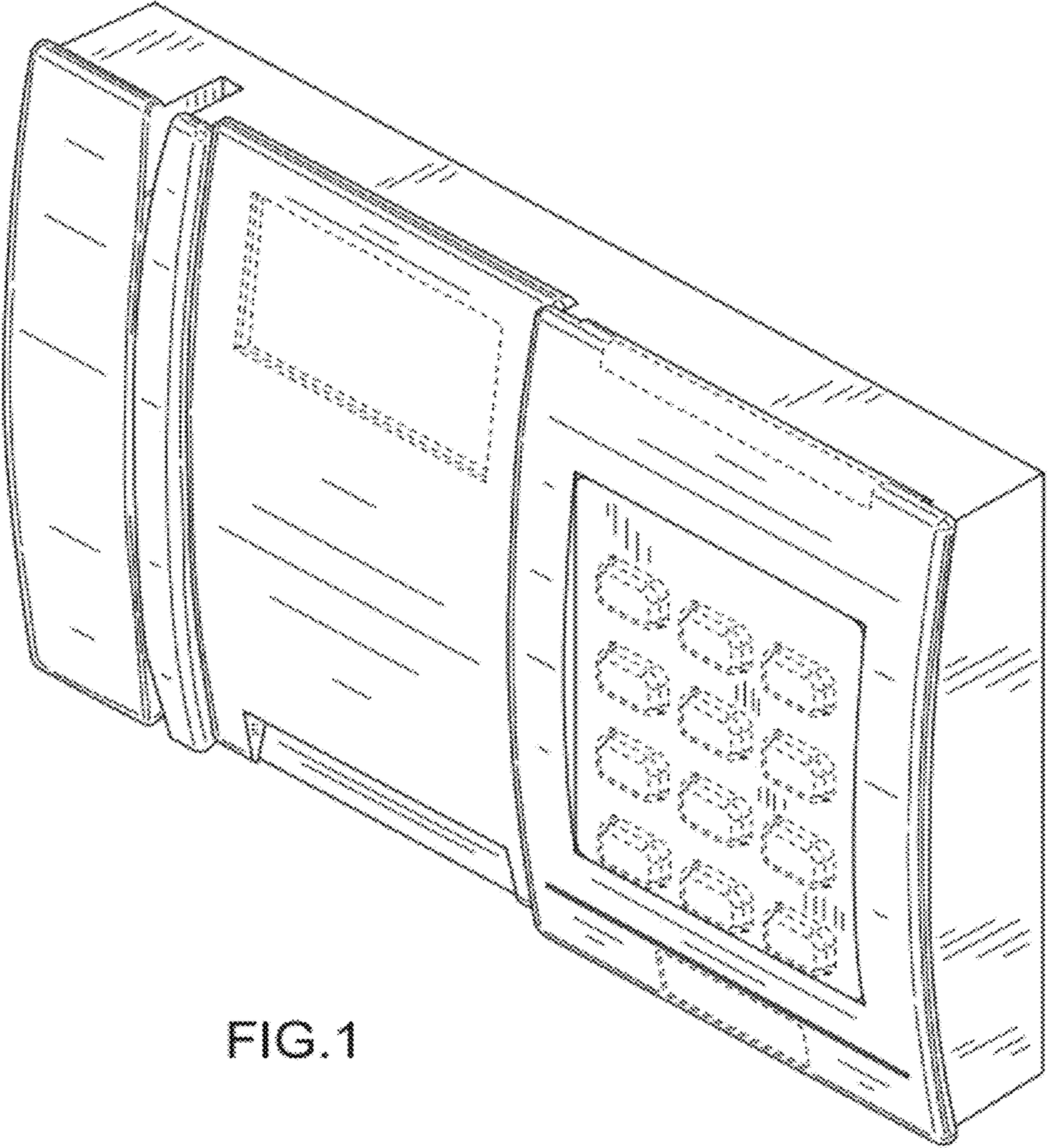

FIG. 1

FIG.2

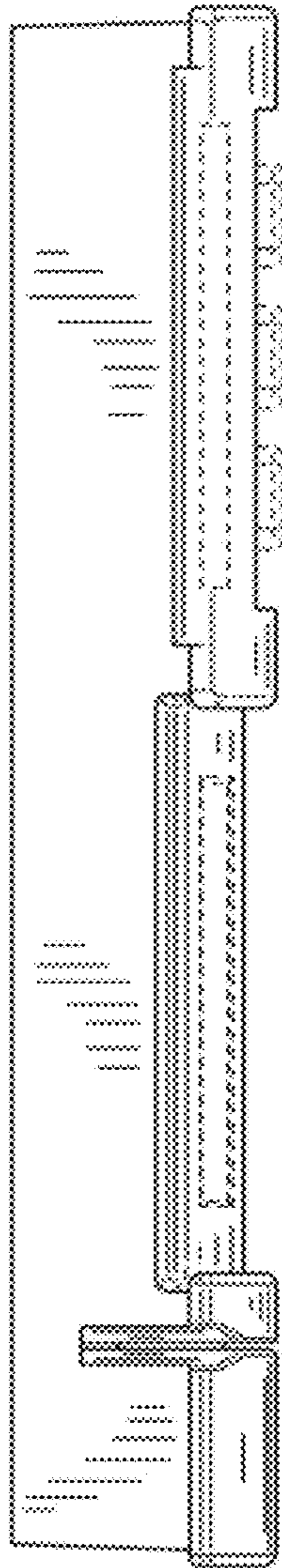
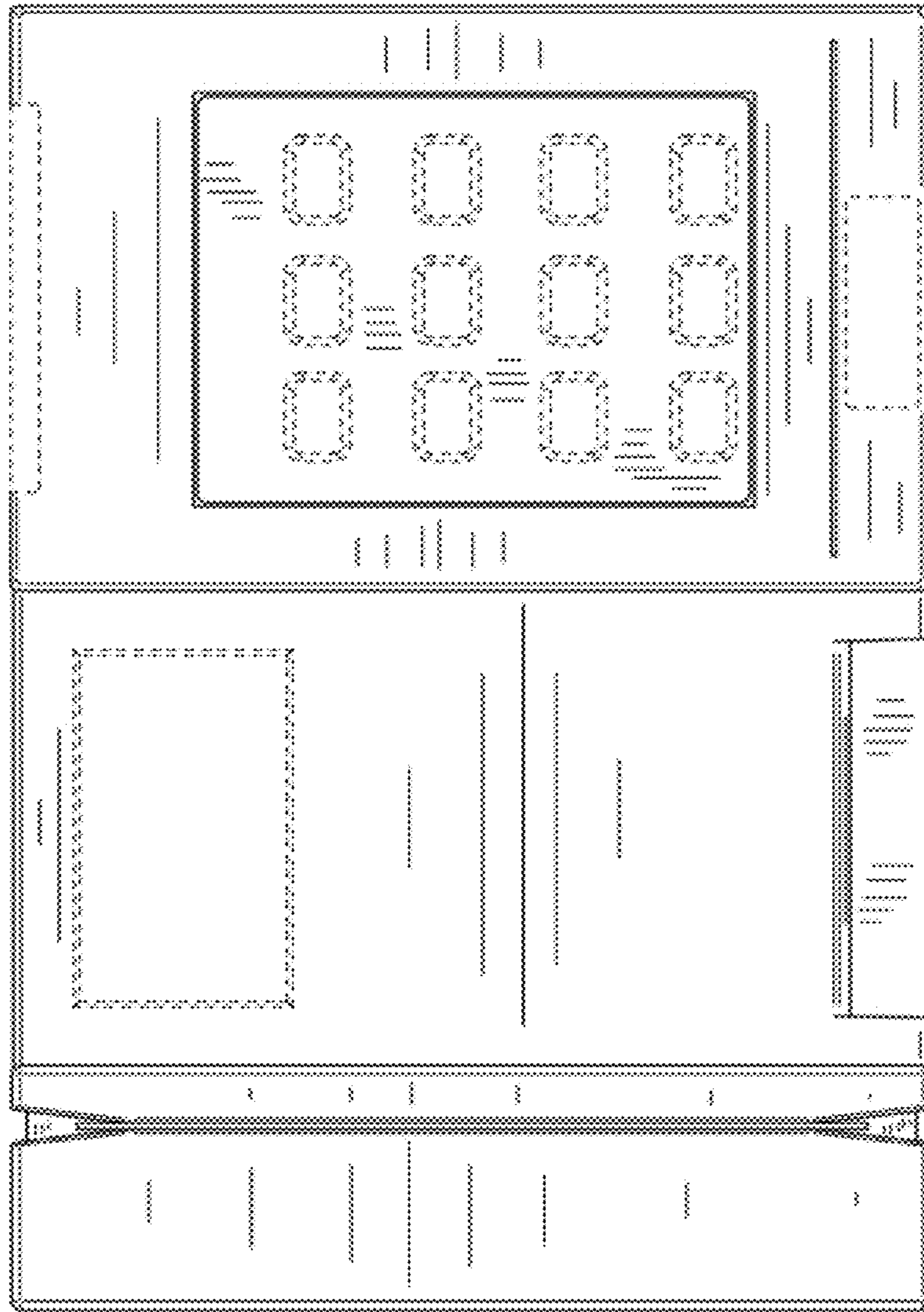

FIG.3



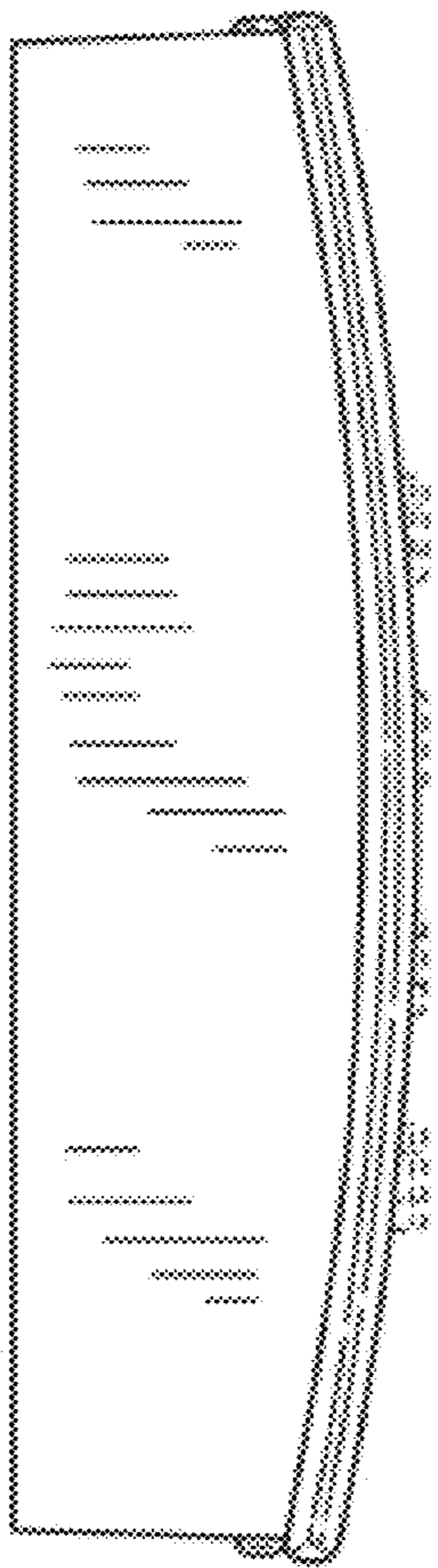

FIG. 4

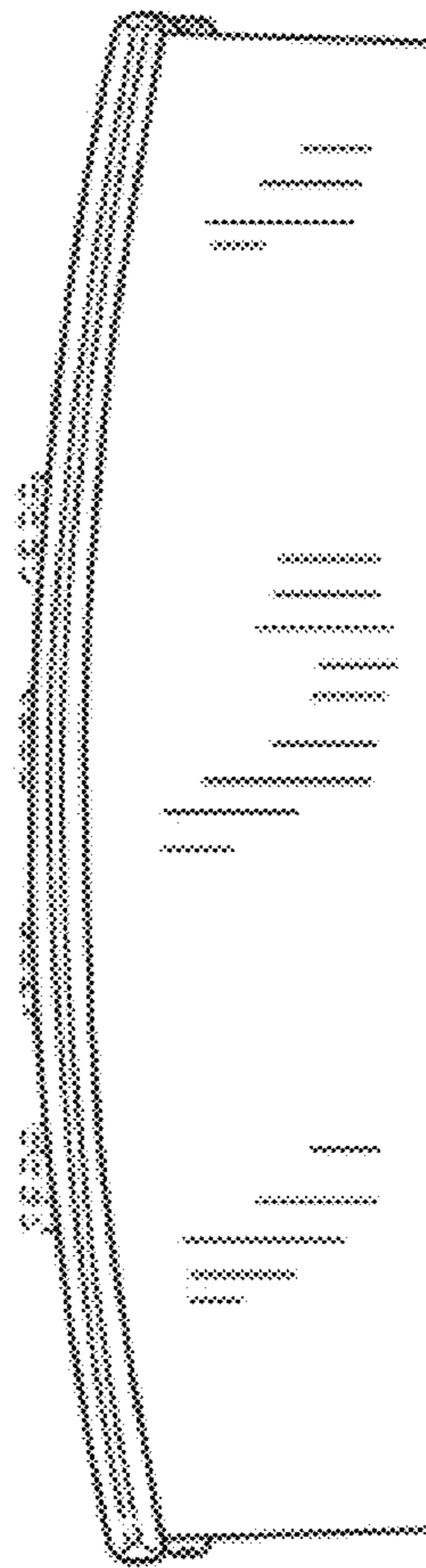

FIG. 5

FIG.6

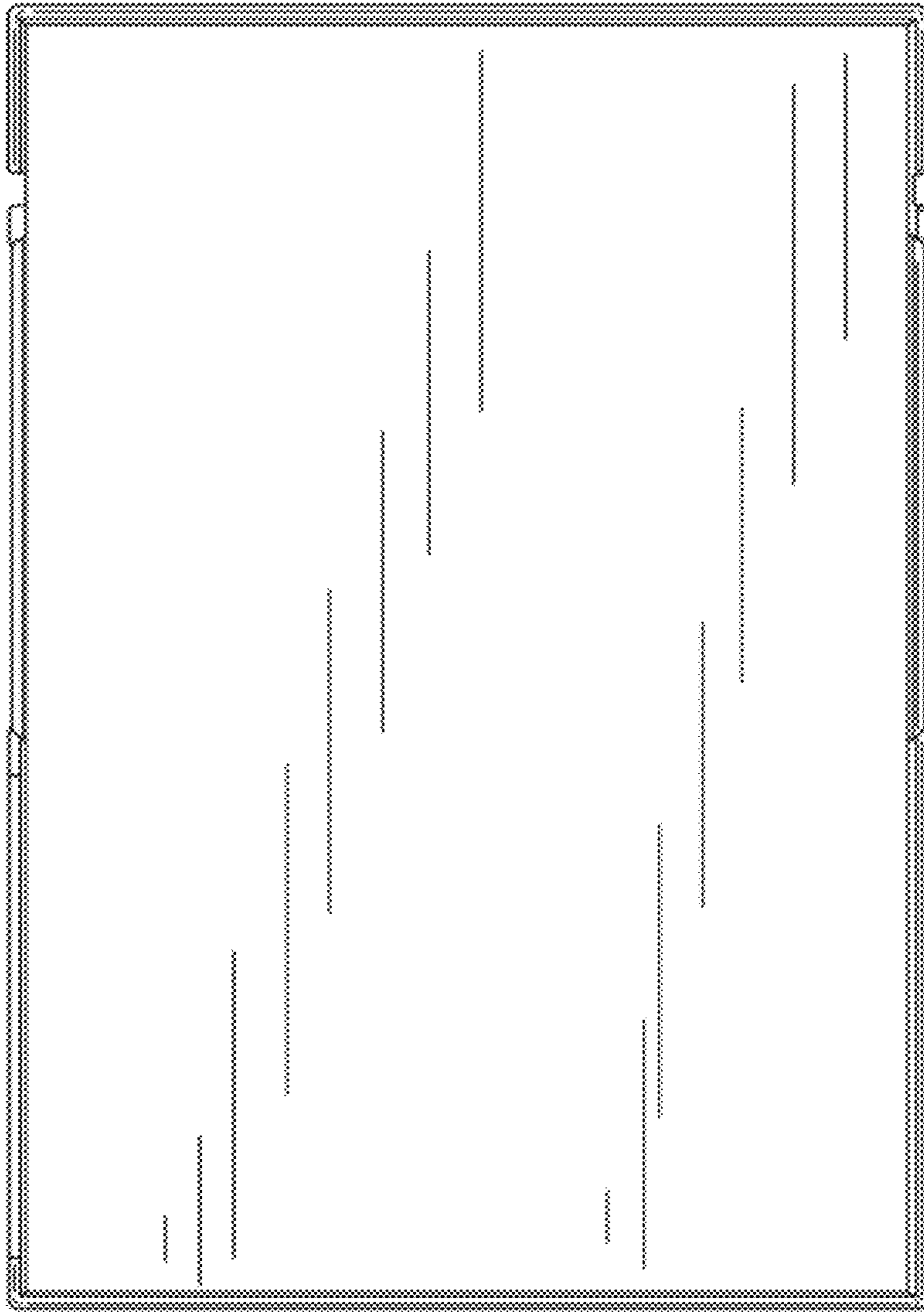

FIG.7

