



US00D673148S

(12) **United States Design Patent**  
**Akana et al.**

(10) **Patent No.:** **US D673,148 S**

(45) **Date of Patent:** **\*\* Dec. 25, 2012**

(54) **ELECTRONIC DEVICE**

(75) Inventors: **Jody Akana**, San Francisco, CA (US); **Bartley K. Andre**, Menlo Park, CA (US); **Jeremy Bataillou**, San Francisco, CA (US); **Daniel J. Coster**, San Francisco, CA (US); **Daniele De Iuliis**, San Francisco, CA (US); **Evans Hankey**, San Francisco, CA (US); **Richard P. Howarth**, San Francisco, CA (US); **Jonathan P. Ive**, San Francisco, CA (US); **Steve Jobs**, Palo Alto, CA (US); **Duncan Robert Kerr**, San Francisco, CA (US); **Shin Nishibori**, Portola Valley, CA (US); **Matthew Dean Rohrbach**, San Francisco, CA (US); **Peter Russell-Clarke**, San Francisco, CA (US); **Christopher J. Stringer**, Woodside, CA (US); **Eugene Antony Whang**, San Francisco, CA (US); **Rico Zorkendorfer**, San Francisco, CA (US)

(73) Assignee: **Apple Inc.**, Cupertino, CA (US)

(\*\*) Term: **14 Years**

(21) Appl. No.: **29/398,611**

(22) Filed: **Aug. 2, 2011**

**Related U.S. Application Data**

(63) Continuation of application No. 29/367,997, filed on Aug. 16, 2010, now Pat. No. Des. 642,563.

(51) **LOC (9) Cl.** ..... **14-02**

(52) **U.S. Cl.** ..... **D14/341**

(58) **Field of Classification Search** ..... D14/341-347, D14/137, 138, 138.1, 138 AA, 138 R, 138 AB, D14/138 AC, 138 AD, 138 C, 138 G, 496, D14/203.1, 203.3, 203.4, 203.5, 203.6, 203.7, D14/426, 427, 428, 432, 429, 129, 130, 420, D14/439-441, 448, 125, 147, 156, 218, 247-248, D14/250, 389, 336; D10/65, 104; D18/6-7; D21/29, 686, 33, 324, 329, 330; D6/596, D6/601, 605; D19/60; 345/169, 901, 905; 348/169; 361/814; 341/122; 346/173; 379/433.04, 379/433.07, 433.11, 433.12, 433.13, 910, 379/916, 433.01, 433.06

See application file for complete search history.

(56) **References Cited**

U.S. PATENT DOCUMENTS

2,424,630 A 7/1947 Perez  
(Continued)

FOREIGN PATENT DOCUMENTS

AU 315078 7/2007  
(Continued)

OTHER PUBLICATIONS

Amazon, "Developing Tablet PC Applications—(Charles River Media Programming)," (<http://www.amazon.co.uk/Developing-Tablet-Applications-Charles-Programming/dp/1584502525>), retrieved Jul. 20, 2011, 4 pages.

(Continued)

*Primary Examiner* — Barbara Fox

(74) *Attorney, Agent, or Firm* — Sterne, Kessler, Goldstein & Fox PLLC

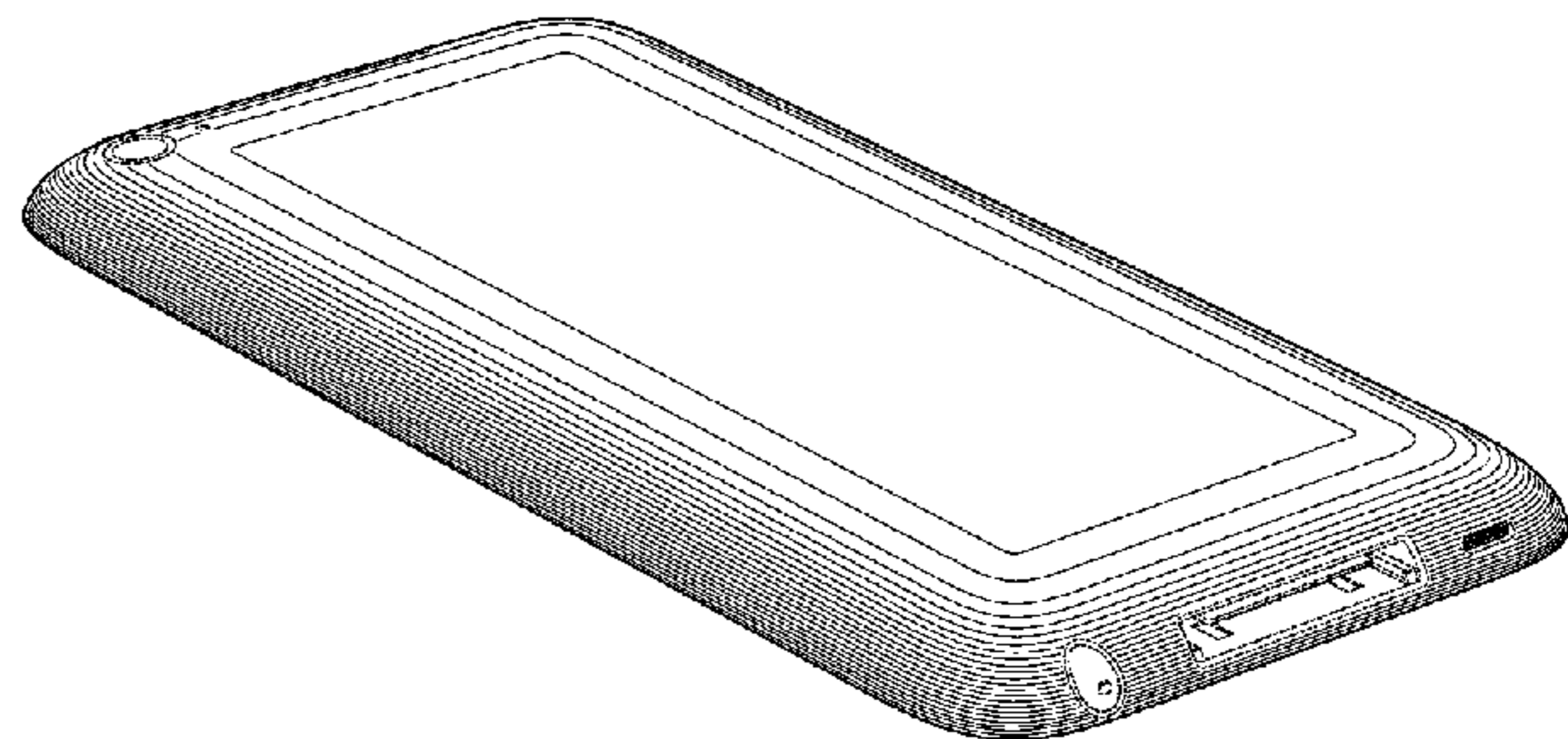
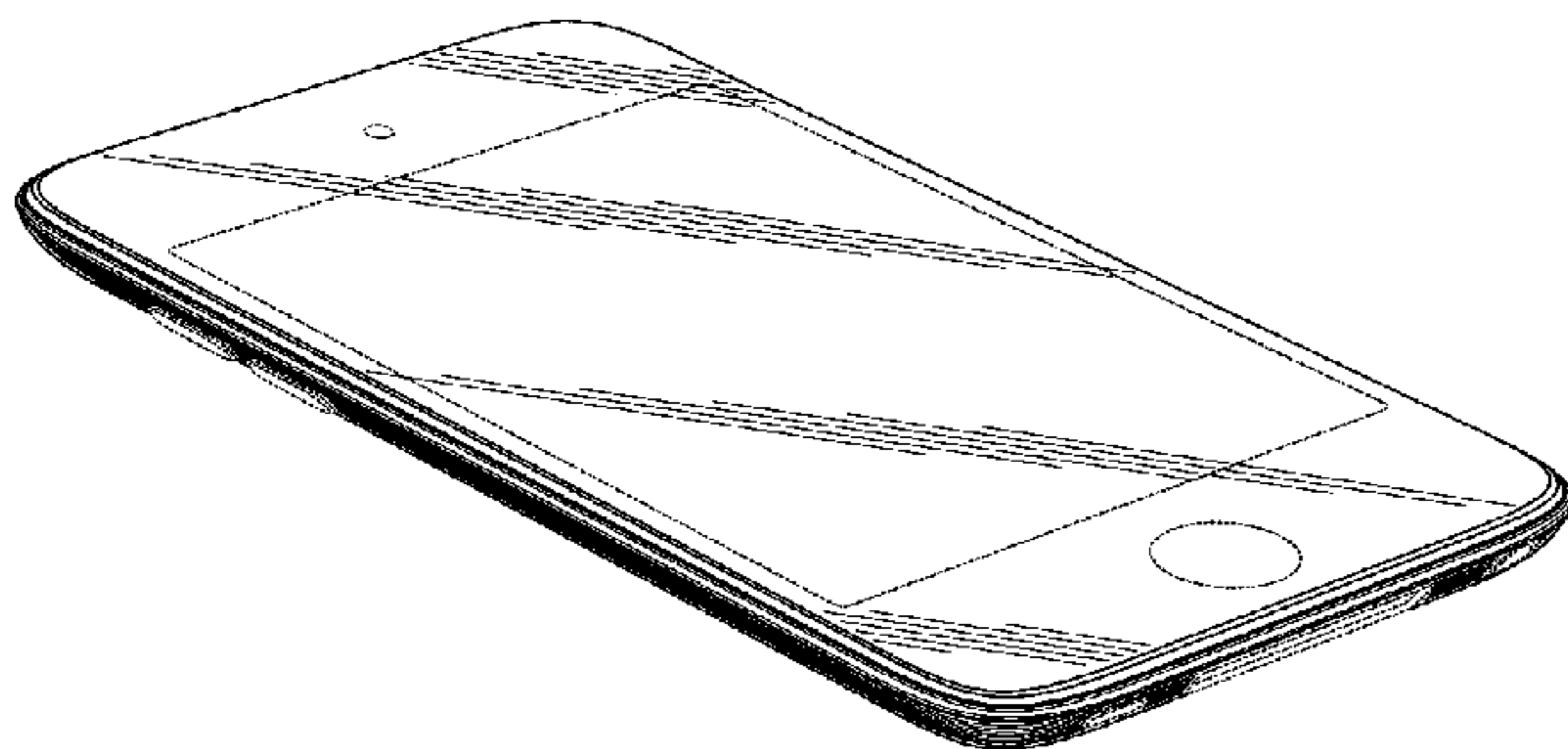
(57) **CLAIM**

The ornamental design for an electronic device, as shown and described.

**DESCRIPTION**

FIG. 1 is a front bottom perspective view of an electronic device showing our new design; FIG. 2 is a rear bottom perspective view thereof; FIG. 3 is a rear top perspective view thereof; FIG. 4 is a front top perspective view thereof; FIG. 5 is a front view thereof; FIG. 6 is a rear view thereof; FIG. 7 is a side view thereof; FIG. 8 is another side view thereof; FIG. 9 is a top view thereof; FIG. 10 is a bottom view thereof; and, FIG. 11 is an enlarged view of a portion of the electronic device taken in FIG. 10. The shade lines in the Figures show contour or transparency and not surface ornamentation. The broken lines shown in the Figures show unclaimed portions of the electronic device and form no part of the claimed design.

**1 Claim, 8 Drawing Sheets**





# US D673,148 S

Page 2

U.S. PATENT DOCUMENTS					
D262,151 S	12/1981	Sussman	D502,945 S	3/2005	Huang et al.
D265,326 S	7/1982	Sugiyama	D503,699 S	4/2005	Lee et al.
D270,061 S	8/1983	Ackeret	D504,889 S *	5/2005	Andre et al. .... D14/341
D270,062 S	8/1983	Ackeret	D505,950 S	6/2005	Summit et al.
D270,063 S	8/1983	Ackeret	D507,003 S	7/2005	Pai et al.
D270,066 S	8/1983	Ackeret	D509,202 S	9/2005	Lee et al.
D278,276 S	4/1985	Bakic	D509,760 S	9/2005	Burrell et al.
D284,084 S	6/1986	Ferrara, Jr.	D509,833 S	9/2005	Yang
D289,873 S	5/1987	Gemmell et al.	D510,929 S	10/2005	Laverick et al.
D306,583 S	3/1990	Krolopp et al.	D511,342 S	11/2005	Chien
D308,055 S	5/1990	Tedham et al.	D511,347 S	11/2005	Naruki
D317,609 S	6/1991	Wei	D514,121 S	1/2006	Johnson
D321,215 S	10/1991	Shamis	D514,558 S	2/2006	Nagel et al.
D332,328 S	1/1993	Lombardi, Jr.	D514,590 S	2/2006	Naruki
D333,574 S	3/1993	Ackeret	D519,116 S	4/2006	Tanaka et al.
D337,322 S	7/1993	Yang	D519,523 S	4/2006	Chiu et al.
D337,569 S *	7/1993	Kando ..... D14/341	D519,998 S	5/2006	Park
D340,701 S	10/1993	Takeuchi	D520,020 S	5/2006	Senda et al.
D340,917 S	11/1993	Sakaguchi et al.	D521,023 S	5/2006	Kim et al.
D345,346 S	3/1994	Alfonso et al.	7,042,712 B2	5/2006	Ghosh et al.
D346,589 S	5/1994	Andros	D524,809 S	7/2006	Alcouloumre et al.
D346,793 S	5/1994	Iino et al.	D525,226 S	7/2006	Jang
5,345,543 A	9/1994	Capps et al.	D525,620 S	7/2006	Esslinger et al.
5,398,310 A	3/1995	Tchao et al.	D525,987 S	8/2006	Kim
D361,552 S	8/1995	Iino	D526,301 S	8/2006	Shin
5,463,725 A	10/1995	Henckel et al.	D526,302 S	8/2006	Kim
5,495,566 A	2/1996	Kwatinetz	D527,015 S	8/2006	Yang
D395,639 S	6/1998	Ham et al.	D527,366 S	8/2006	Lee
D396,215 S	7/1998	Inukai	D528,542 S	9/2006	Luminosu et al.
D396,452 S	7/1998	Naruki	D528,561 S	9/2006	Ka-Wei et al.
D408,372 S	4/1999	Ota et al.	D529,045 S	9/2006	Shin
D408,794 S	4/1999	Ogasawara	D530,699 S	10/2006	Lee et al.
D409,185 S	5/1999	Kawashima	D531,610 S	11/2006	Kim et al.
D410,440 S	6/1999	Carnell	D532,766 S	11/2006	Lee
D420,354 S	2/2000	Morales	D532,791 S	11/2006	Kim
D424,535 S	5/2000	Peltola	D533,531 S	12/2006	Hyun et al.
D425,887 S	5/2000	Edwards et al.	D534,143 S	12/2006	Lheem
6,061,063 A	5/2000	Wagner et al.	D534,145 S	12/2006	Lheem
6,067,068 A	5/2000	Hussain	D534,516 S	1/2007	Lheem
D444,465 S	7/2001	Do	D534,517 S	1/2007	Cho et al.
D448,764 S	10/2001	Marsalka et al.	D535,281 S	1/2007	Yang
6,310,610 B1	10/2001	Beaton et al.	D536,329 S	2/2007	Lee
D451,505 S	12/2001	Iseki et al.	D536,691 S	2/2007	Park
D452,687 S	1/2002	Yeh	D536,962 S	2/2007	Tanner
6,337,698 B1	1/2002	Keely, Jr. et al.	D538,822 S	3/2007	Andre et al.
D453,333 S	2/2002	Chen	D541,298 S	4/2007	Andre et al.
D454,348 S	3/2002	Yeh	D541,299 S	4/2007	Andre et al.
D455,433 S	4/2002	Alviar et al.	D541,785 S	5/2007	Hwang et al.
D456,023 S	4/2002	Andre et al.	D543,183 S	5/2007	Cho et al.
D456,805 S	5/2002	Ono et al.	D546,313 S	7/2007	Lheem
D458,252 S	6/2002	Palm et al.	D548,713 S	8/2007	Lee et al.
D461,802 S	8/2002	Tu	D548,732 S	8/2007	Cebe et al.
D466,501 S	12/2002	Hirota	D548,747 S	8/2007	Andre et al.
D467,890 S	12/2002	Lai et al.	D554,098 S	10/2007	Lee
6,501,967 B1	12/2002	Makela et al.	D556,211 S	11/2007	Howard
D469,413 S	1/2003	To et al.	D557,238 S	12/2007	Kim
6,509,907 B1	1/2003	Kuwabara	D557,239 S	12/2007	Lee
D483,032 S	12/2003	Bertrand et al.	D557,243 S	12/2007	Kim et al.
D483,359 S	12/2003	Lin et al.	D557,259 S	12/2007	Hirsch
D485,265 S	1/2004	Sato et al.	7,303,424 B2	12/2007	Tu et al.
D486,149 S	2/2004	Kawami et al.	D558,460 S	1/2008	Yu et al.
6,690,387 B2	2/2004	Zimmerman et al.	D558,716 S	1/2008	Bae et al.
D488,468 S	4/2004	Hu	D558,726 S	1/2008	Wang et al.
D488,469 S	4/2004	Batsikas	D558,756 S	1/2008	Andre et al.
D489,062 S	4/2004	Hong	D558,757 S *	1/2008	Andre et al. .... D14/341
D489,731 S	5/2004	Huang	D558,758 S	1/2008	Andre et al.
D490,810 S	6/2004	Huang	D558,792 S	1/2008	Chigira
D491,156 S	6/2004	Kawakami et al.	D559,220 S	1/2008	Lee et al.
D492,684 S	7/2004	Ozolins et al.	D560,192 S	1/2008	Lee et al.
D494,188 S	8/2004	Huang	D560,227 S	1/2008	Bennett et al.
D495,695 S	9/2004	Yugaya	D560,683 S	1/2008	Lee
D496,645 S	9/2004	Yoo et al.	D560,686 S	1/2008	Kim
6,788,527 B2	9/2004	Doczy et al.	D561,153 S	2/2008	Hong et al.
D497,364 S	10/2004	Ozolins et al.	D561,204 S	2/2008	Toh
D498,754 S	11/2004	Blyth	D561,782 S *	2/2008	Kim ..... D14/496
D499,423 S	12/2004	Bahroocha et al.	D562,285 S	2/2008	Lim
D500,037 S	12/2004	Ozolins et al.	D562,794 S	2/2008	Kim et al.
D502,173 S	2/2005	Jung et al.	D563,432 S	3/2008	Kim
			D563,929 S	3/2008	Park



# US D673,148 S

D565,532 S	4/2008	Arnold		D641,018 S *	7/2011	Lee et al. ....	D14/341
D565,596 S *	4/2008	Kim .....	D14/496	D642,563 S	8/2011	Akana et al.	
D565,599 S	4/2008	Jang et al.		D643,827 S *	8/2011	Lee et al. ....	D14/138 G
D568,309 S	5/2008	Cebe et al.		D645,015 S *	9/2011	Lee et al. ....	D14/138 G
D569,830 S	5/2008	Kwak		D645,017 S *	9/2011	Kim et al. ....	D14/138 G
D570,320 S	6/2008	Lee et al.		D645,833 S *	9/2011	Seflic et al. ....	D14/138 G
D570,346 S	6/2008	Suk et al.		D646,253 S *	10/2011	Kim et al. ....	D14/138 G
D570,839 S	6/2008	Hofer et al.		D646,255 S *	10/2011	Kim .....	D14/138 G
D573,143 S	7/2008	Park et al.		8,081,886 B2	12/2011	Okano	
D574,015 S	7/2008	Masui		2003/0125079 A1	7/2003	Park et al.	
D575,259 S	8/2008	Kim et al.		2003/0125094 A1	7/2003	Hyun et al.	
7,409,059 B2	8/2008	Fujisawa		2003/0125959 A1	7/2003	Palmquist et al.	
D579,905 S	11/2008	Kim et al.		2003/0184525 A1	10/2003	Tsai	
D579,930 S	11/2008	Maskatia		2004/0021676 A1	2/2004	Chen et al.	
D580,387 S *	11/2008	Andre et al. ....	D14/138 G	2004/0041504 A1	3/2004	Ozolins et al.	
D581,922 S	12/2008	Andre et al.		2004/0132499 A1	7/2004	Abe	
D583,346 S *	12/2008	Jung et al. ....	D14/138 AD	2004/0155888 A1	8/2004	Padgitt et al.	
D584,738 S *	1/2009	Kim et al. ....	D14/496	2004/0166907 A1	8/2004	Yajima	
D585,411 S	1/2009	Eaton		2004/0223004 A1	11/2004	Lincke et al.	
D586,800 S *	2/2009	Andre et al. ....	D14/341	2004/0242288 A1	12/2004	Balle et al.	
D589,979 S	4/2009	Andre et al.		2004/0257334 A1	12/2004	Yajima	
D593,087 S *	5/2009	Andre et al. ....	D14/341	2005/0009556 A1	1/2005	Hickey et al.	
D597,067 S	7/2009	Oh et al.		2005/0012723 A1	1/2005	Pallakoff	
D599,342 S *	9/2009	Andre et al. ....	D14/341	2005/0014538 A1	1/2005	Hyun et al.	
D600,241 S *	9/2009	Andre et al. ....	D14/341	2005/0041385 A1	2/2005	Kikinis et al.	
D601,558 S *	10/2009	Andre et al. ....	D14/341	2005/0059438 A1	3/2005	Jellicoe	
D601,583 S	10/2009	Andre et al.		2005/0088418 A1	4/2005	Nguyen	
D602,014 S *	10/2009	Andre et al. ....	D14/341	2005/0127158 A1	6/2005	Figueras et al.	
D602,015 S *	10/2009	Andre et al. ....	D14/341	2005/0130715 A1	6/2005	Fujisawa	
D602,016 S *	10/2009	Andre et al. ....	D14/341	2005/0195154 A1	9/2005	Robbins et al.	
D602,017 S *	10/2009	Andre et al. ....	D14/341	2005/0255897 A1	11/2005	Lee et al.	
D602,486 S *	10/2009	Andre et al. ....	D14/341	2006/0025184 A1	2/2006	Cho et al.	
D602,488 S *	10/2009	Jiang et al. ....	D14/341	2006/0025218 A1	2/2006	Hotta	
D604,297 S *	11/2009	Andre et al. ....	D14/341	2006/0094464 A1	5/2006	Kyou et al.	
D607,428 S	1/2010	Kim et al.		2006/0111158 A1	5/2006	Hou	
7,658,675 B2	2/2010	Hotta		2006/0111161 A1	5/2006	Cha et al.	
7,688,574 B2	3/2010	Zadesky et al.		2006/0121852 A1	6/2006	Kim et al.	
D613,735 S *	4/2010	Andre et al. ....	D14/341	2006/0142073 A1	6/2006	Gordecki	
D613,736 S *	4/2010	Andre et al. ....	D14/341	2006/0166713 A1	7/2006	Yeh et al.	
7,697,281 B2 *	4/2010	Dabov et al. ....	361/679.55	2006/0281501 A1	12/2006	Zuo et al.	
D615,083 S *	5/2010	Andre et al. ....	D14/341	2007/0082718 A1	4/2007	Yoon et al.	
D615,945 S	5/2010	Kim et al.		2008/0004083 A1	1/2008	Ohki et al.	
D618,204 S *	6/2010	Andre et al. ....	D14/203.7	2008/0004085 A1	1/2008	Jung et al.	
D620,004 S	7/2010	Andre et al.		2008/0316121 A1 *	12/2008	Hobson et al. ....	343/702
D621,825 S	8/2010	Andre et al.		2009/0067141 A1 *	3/2009	Dabov et al. ....	361/753
D622,718 S	8/2010	Andre et al.		2009/0245564 A1 *	10/2009	Mittleman et al. ....	381/361
D622,719 S	8/2010	Andre et al.					
D622,720 S *	8/2010	Andre et al. ....	D14/341				
D624,072 S	9/2010	Andre et al.					
D624,536 S *	9/2010	Andre et al. ....	D14/341				
D626,937 S *	11/2010	Yeo et al. ....	D14/203.7				
D627,343 S	11/2010	Andre et al.					
D627,344 S	11/2010	Chien et al.					
D627,777 S	11/2010	Akana et al.					
D627,778 S	11/2010	Akana et al.					
D629,799 S	12/2010	Andre et al.					
D630,630 S *	1/2011	Andre et al. ....	D14/341				
7,869,206 B2 *	1/2011	Dabov et al. ....	361/679.55				
D633,090 S	2/2011	Andre et al.					
D633,091 S *	2/2011	Andre et al. ....	D14/341				
D633,092 S	2/2011	Andre et al.					
D633,493 S	3/2011	Akana et al.					
D633,908 S	3/2011	Akana et al.					
D634,319 S	3/2011	Andre et al.					
D634,742 S *	3/2011	Andre et al. ....	D14/341				
D635,540 S	4/2011	Kim et al.					
D635,952 S	4/2011	Park et al.					
D636,390 S	4/2011	Andre et al.					
D636,770 S *	4/2011	Li .....	D14/341				
D637,596 S *	5/2011	Akana et al. ....	D14/341				
D638,814 S *	5/2011	Sutherland et al. ....	D14/138 G				
D638,815 S *	5/2011	Lee et al. ....	D14/138 G				
D638,835 S	5/2011	Akana et al.					
D639,266 S *	6/2011	DeLorenzo et al. ....	D14/142				
D639,805 S *	6/2011	Song et al. ....	D14/341				
D640,218 S *	6/2011	Ahn et al. ....	D14/138 G				
D640,219 S *	6/2011	Sutherland et al. ....	D14/138 G				
D640,663 S *	6/2011	Arnholt et al. ....	D14/138 G				
D641,017 S *	7/2011	Meng .....	D14/341				

## FOREIGN PATENT DOCUMENTS

CA	72548	5/1993
CA	101263	1/2004
CN	300721990	12/2007
CN	300732852	1/2008
CN	300732857	1/2008
CN	300781645	5/2008
CN	300912552	4/2009
CN	300912572	4/2009
CN	300881212	12/2009
EM	000048061-0001	8/2003
EM	000046198-0001	11/2003
EM	000317490-0001	5/2005
EM	000257621-0004	7/2005
EM	000375191-0001	9/2005
EM	000493721-0002	5/2006
EM	000359157-0005	9/2006
EM	000569157-0007	9/2006
EM	000590831-0001	10/2006
EM	000614565-0001	12/2006
EM	000661103-0001	2/2007
EM	00066789-0001	3/2007
EM	000718770-0007	6/2007
EM	000748280-0001	8/2007
EM	000748280-0006	8/2007
EM	000767959-0001	8/2007
EM	000748314-0001	10/2007
EM	000874466-0012	3/2008
EM	000888920-0018	5/2008
EM	000939731-0001	6/2008
EM	001098149-0001	4/2009
EM	001694712-0001	4/2010



ES	0505712-01	4/2008
FI	4897	7/1980
FR	990052-001	5/1999
GB	2062780	5/1981
GB	1042780	12/1986
GB	2030050	10/1992
GB	2033245	8/1993
GB	3010002	2/2003
GB	3012502	6/2003
GB	3014024	10/2003
GB	3022447	10/2005
JP	61-69284	4/1986
JP	64-9317	1/1989
JP	000921403	3/1995
JP	001009317	5/1998
JP	2000-163031	6/2000
JP	001104685	3/2001
JP	1124750	10/2001
JP	001142127	5/2002
JP	1159881	12/2002
JP	1178470	7/2003
JP	001188041	10/2003
JP	1204221	5/2004
JP	2004-290256	10/2004
JP	001235888	4/2005
JP	1241383	6/2005
JP	001241638	6/2005
JP	1247215	8/2005
JP	1250487	9/2005
JP	1263649	2/2006
JP	001280315	9/2006
JP	1285057	10/2006
JP	1295003	2/2007
JP	1207560	6/2007
JP	1302929	6/2007
JP	138724	3/2010
KR	30-0327126	6/2003
KR	30-0359572	8/2004
KR	30-0360712	9/2004
KR	30-0364027	10/2004
KR	30-0364845	10/2004
KR	30-0367347	11/2004
KR	30-0367787	11/2004
KR	30-0370833	1/2005
KR	30-0376524	3/2005
KR	30-0387059-3	7/2005
KR	30-0387130	7/2005
KR	30-0387648	7/2005
KR	30-0396917	11/2005
KR	30-0398307	11/2005
KR	30-0394921-1	12/2005
KR	30-0416409	6/2006
KR	30-0418422-1	7/2006
KR	30-0418547	7/2006
KR	30-0420200	7/2006
KR	30-0422221	8/2006
KR	30-0424148	9/2006
KR	30-0435318	1/2007
KR	30-0441230	2/2007
KR	30-0452432	6/2007
KR	30-0454592	7/2007
KR	30-0452985	8/2007
KR	30-0467088	10/2007
KR	30-0721986	12/2007
KR	30-0529167	5/2009
KR	30-0532172	6/2009
KR	30-0533504	7/2009
KR	30-0546031	11/2009
SE	55044	10/1993
TW	106137	8/2005
TW	123283	6/2008
TW	126454	12/2008
TW	127018	1/2009
TW	139834	4/2011
TW	140380	5/2011
TW	140385	5/2011
WO	WO 00/74240	7/2000
WO	WO 01/88679 A2	11/2001
WO	WO 2004/023272	3/2004

## OTHER PUBLICATIONS

Association for Computing Machinery, The Open Video Project, "ACM CHI 1995—The Tablet Newspaper: A vision for the Future," (<http://www.open-video.org/details.php?videoid=8315&surrogate=storyboard>), 3 pages (1994).

Aumente, J., *American Journalism Review*, "Panel Vision," (<http://www.ajr.org/Article.asp?id=1257>), published Oct. 1994, 7 pages.

Blickenstorfer, C., *PenComputing Magazine*, "Tablet PCs: HP Compaq Tablet PC TC1000," ([http://pencomputing.com/frames/tpc\\_compaq.html](http://pencomputing.com/frames/tpc_compaq.html)), 3 pages (Dec. 2002).

Blickenstorfer, C., *PenComputing Magazine*, "Tablet PCs: Motion Computing M1200," ([http://pencomputing.com/frames/tpc\\_motion1200.html](http://pencomputing.com/frames/tpc_motion1200.html)), 3 pages (Dec. 2002).

Blickenstorfer, C., *PenComputing Magazine*, "Tablet PCs: ViewSonic V1100," ([http://pencomputing.com/frames/tpc\\_viewsonic.html](http://pencomputing.com/frames/tpc_viewsonic.html)), 3 pages (Dec. 2002).

Chi-atheneum, "Good Design 2003, An International Industrial and Graphic Design Competition," (<http://www.chi-atheneum.org/gdesign/winners03.htm>), retrieved Sep. 23, 2011, 7 pages.

Computing History, "GRidPad 1910," (<http://www.computinghistory.org.uk/det/6565/GRidPad-1910>), retrieved Sep. 12, 2011, 2 pages.

DigiBarn Systems, "GRiDpad Pen Computer," (<http://www.digibarn.com/collections/systems/gridpad/index.html>), retrieved Sep. 23, 2011, 2 pages.

Edible Apple, "The first Apple Tablet . . . from 1979," (<http://www.edibleapple.com/the-first-apple-tablet-from-1979/>), published Nov. 23, 2009, 8 pages.

Electronista, "LG/Prada phone revealed?," (<http://www.electronista.com/articles/06/12/20/lg.prada.phone.revealed/>), updated Dec. 20, 2006, 9 pages.

EngineerBoy, *CleverDonkey.com*, "2001:A Space Odyssey and the iPad (or is it tamPod?)," (<http://www.cleverdonkey.com/1499-2001a-space-odyssey-and-the-ipad-or-is-it-tampod/>), published Feb. 2, 2010, 5 pages.

Hagen, R. *GadgetZone*, "iHolic portable mediaspeler," (<http://www.gadgetzone.nl/nieuws.php?id=3191>), published Jan. 4, 2007, 3 pages.

Martin, T., "The Tablet Newspaper: A Vision for the Future," *Human Factors in Computing Systems, Chi '95 Conference Companion*, pp. 425, Colorado, United States (May 1995).

NewLaunches, "LG Prada cell phones are truly iconic," ([http://www.newlaunches.com/archives/lg\\_prada\\_cell\\_phones\\_are\\_truly\\_iconic.php](http://www.newlaunches.com/archives/lg_prada_cell_phones_are_truly_iconic.php)), retrieved Sep. 12, 2011, 3 pages.

NewLaunches, "LG Wears Prada," ([http://www.newlaunches.com/archives/lg\\_wears\\_prada.php](http://www.newlaunches.com/archives/lg_wears_prada.php)), retrieved Sep. 23, 2011, 2 pages.

PC Magazine, "HP Compaq Tablet PC TC1000," (<http://www.pcmag.com/article2/0,2817%20,939500,00.asp>), published Apr. 8, 2003, 3 pages.

Samsung, "Samsung F700 is razendsnelle alleskunner voor mobiel breedband van Vodafone," ([http://www.samsung.com/nl/mobile/pressView.do?ptype=press&page=&news\\_seq=22544](http://www.samsung.com/nl/mobile/pressView.do?ptype=press&page=&news_seq=22544)), published May 25, 2008, 2 pages.

Samsung, "Samsung Unveils Revolutionary Ultra Smart F700," ([http://www.samsung.com/us/news/newsRead.do?news\\_seq=3516](http://www.samsung.com/us/news/newsRead.do?news_seq=3516)), published Feb. 8, 2007, 2 pages.

Van Reeth, J., "Vantage is showing its colours!," *Home automation journal* 11:1-8, Vantage Emea, Belgium (Jun. 2003).

Wikipedia, "Etch A Sketch," ([http://en.wikipedia.org/wiki/Etch\\_a\\_sketch](http://en.wikipedia.org/wiki/Etch_a_sketch)), last modified Aug. 24, 2011, 4 pages.

Wikipedia, "MessagePad," (<http://en.wikipedia.org/wiki/Messagepad>), retrieved Sep. 12, 2011, 10 pages.

ZDNet, "Viewsonic V1100," (<http://www.zdnet.nl/reviews/24712/viewsonic-v1100/>), published Feb. 17, 2003, 9 pages.

Ziegler, C., *Engadget*, "The LG KE850: touchable chocolate," (<http://mobile.engadget.com/2006/12/15/the-lg-ke850-touchable-chocolate/>), published Dec. 15, 2006, 5 pages.

U.S. Appl. No. 29/381,617, "Electronic Device", filed Dec. 21, 2010.

U.S. Appl. No. 29/384,757, "Electronic Device", filed Feb. 3, 2011.

U.S. Appl. No. 29/384,861, "Electronic Device", filed Feb. 4, 2011.

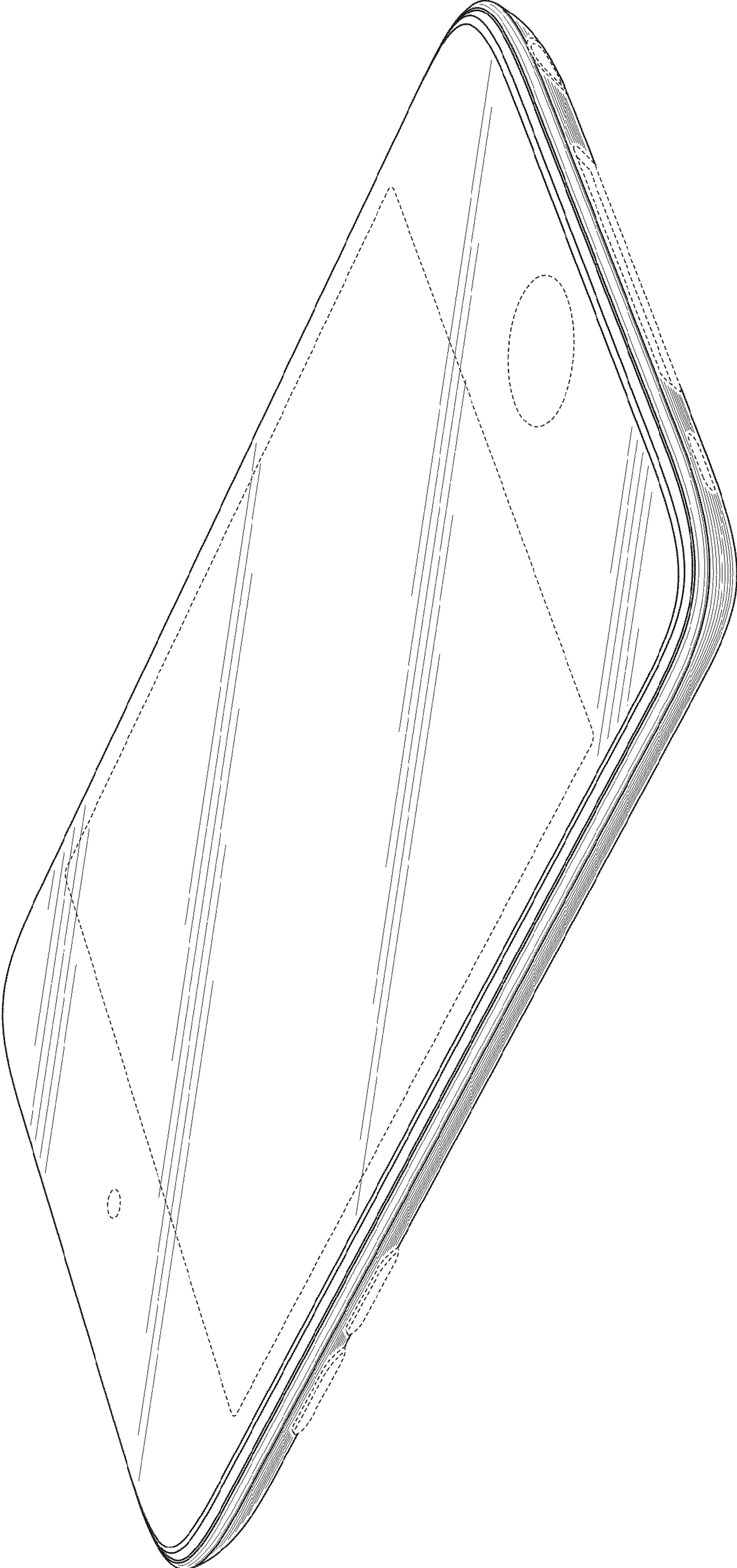


- FinalSense, "Samsung Ultra Smart F520 Dual Slider Phone," ([http://www.finalsense.com/news/it/phone/samsung\\_f520.htm](http://www.finalsense.com/news/it/phone/samsung_f520.htm)), published Feb. 2007, 3 pages.
- Gizmodo, "Touchscreen iPod Due This November Says Our Secret Source," (<http://gizmodo.com/192158/touchscreen-ipod-due-this-november-says-our-secret-source>), published Aug. 4, 2006, 2 pages.
- Gizmodo, "Bluebird PIDION BM-200 Packed with Acronyms and Other Impressive Features," (<http://gizmodo.com/143554/bluebird-pidion-bm+200-packed-with-acronyms-and-other-impressive-features>), published Dec. 15, 2005, 2 pages.
- infoSync, "Preview: LG PM70," (<http://infosyncworld.com/news/n/5869.html>), published Mar. 15, 2005, 2 pages.
- Melanson, D., Engadget, "Meizu M8 / miniOne closer to production, litigation," (<http://www.engadget.com/2007/02/13/meizu-m8-minione-closer-to-production-litigation>), published Feb. 13, 2007, 3 pages.
- Samsung, "Samsung Galaxy S," (<http://www.samsung.com/au/smartphone/galaxys/>), product released Jun. 2010, 2 pages.
- SoftBank, "SoftBank 825SH," (<http://mb.softbank.jp/en/products/sharp/825sh.html>), product released Jul. 2008, 3 pages.
- Svartlinks, Blogspot, "Samsung F700, F520, F510, F500 and F300 Ultra Smart—Smartphones," (<http://svartlinks.blogspot.com/2007/02/samsung-f700-f520-f510-f500-and-f300.html>), published Feb. 13, 2007, 10 pages.
- Vasile, C., Softpedia, "MobilePen: An Expensive but Helpful Tochsreen," (<http://news.softpedia.com/news/MobilePen-An-Expensive-But-Helpful-Touchscreen-16192.shtml>), published Jan. 12, 2006, 2 pages.
- "A Day in the Life of InfoLink," Stanford University Libraries, published May 1, 2003.
- "The Oracle: The Personal Computer of the Year 2000," Stanford University Libraries.
- "The Organizer: The Personal Computer of the Year 2000," Stanford University Libraries.
- "Toshiba Dynapad T100X Pen Computer," product available in 1993, 2 pages.
- ABDI, "Five 1 GB Flash MP3 Players," Tomsguide.com, (<http://www.tomsguide.com/us/five-lgb-flash-mp3-players,review-722-3.html>), published May 30, 2006, 4 pages.
- Aliexpress.com, "WACOM PL-500 15" LCD Tablet Mint," (<http://www.aliexpress.com/product-fm/430172068-WACOM-PL-500-15-LCD-Tablet-Mint-Worldwide-Free-Shipping-wholesalers.html>), accessed Nov. 14, 2011, 3 pages.
- Amazon.com, "Digitalway MPIO FL100 128 MB MP3 Player" (<http://www.amazon.com/Digitalway-MPIO-FL100-128-Player/dp/B00008V6NI>) accessed Nov. 17, 2011, 7 pages.
- Amazon.com, "Whirlpool Gold : GH7208XRS 2.0 cu. ft. Velos Speedcook over the Range Microwave Oven," (<http://www.amazon.com/Whirlpool-Gold-GH7208XRS-Speedcook-Microwave/dp/B000ZIPHM8>), accessed May 23, 2012, 5 pages.
- AndroidTabletFanatic.com "16 Old-Skool Tablets Rocking it Before the iPad," (<http://www.androidtabletfanatic.com/android-tablet-news/16-old-skool-tablets-rocking-it-before-the-ipad/>), published May 16, 2011, 10 pages.
- Apple Inc., "Apple Introduces the U2 iPod," (<http://www.apple.com/pr/library/2004/10/26Apple-Introduces-the-U2-iPod.html>), publishes Oct. 26, 2004, 2 pages.
- Blandford, "Nokia N92 Preview," ([http://www.allaboutsymbian.com/features/item/Nokia\\_N92\\_Preview.php](http://www.allaboutsymbian.com/features/item/Nokia_N92_Preview.php)), published Nov. 23, 2005, 10 pages.
- Block, "Olympus @ CES Hands-on with the m:robe MR-500i and MR-100," Engadget.com, (<http://www.engadget.com/2005/01/10/olympus-ces-hands-on-with-the-m-robe-mr-100>), published Jan. 10, 2005, 3 pages.
- Cell Phones.About.com, "More pictures of the LG KG800," ([http://cellphones.about.com/library/b1-pi-lg\\_kg800.htm](http://cellphones.about.com/library/b1-pi-lg_kg800.htm)), accessed Feb. 13, 2012, 1 page.
- Chip Online, "VIA: Zwitter-PC für Schöngesteir," ([http://www.chip.de/news/VIA-Zwitter-PC-fuer-Schoengeister\\_34204096.html](http://www.chip.de/news/VIA-Zwitter-PC-fuer-Schoengeister_34204096.html)), Published May 8, 2002, 2 pages.
- Clarke, "Newspad by Authur C. Clarke from 2001: A Space Odyssey," (<http://www.technovelgy.com/ct/content.asp?Bnum=529>), published 1968, 3 pages.
- Computex.biz, "Tatung Tablet PC," ([http://www.computex.biz/tatung/Default.aspx?pagetype=ProductDetail&pdt\\_id=36&cid=3...](http://www.computex.biz/tatung/Default.aspx?pagetype=ProductDetail&pdt_id=36&cid=3...)), accessed Nov. 4, 2011, 3 pages.
- dcinside.com, "iHolic HTV-200" (<http://dica.dcinside.com/review.php?pid=7192>), retrieved Sep. 22, 2011, 16 pages.
- Dial-a-Phone.co.uk, "Samsung F700 beats the iPhone!" (<http://blog.dialaphone.co.uk/2007/02/16/samsung-f700-beats-the-iphone/>), published Feb. 16, 2007, 38 pages.
- eFashion Magazine, vol. 119, p. 45, China (Jun. 1, 2005).
- eFashion Magazine, vol. 12, p. 60, China (2004).
- eFashion Magazine, vol. 172, p. 26, China (Apr. 2006).
- Flickr.com "Apple Graphics Tablet" ([http://farm3.static.flickr.com/2691/4126733086\\_b24c987b0c\\_o.jpg](http://farm3.static.flickr.com/2691/4126733086_b24c987b0c_o.jpg)), accessed Nov. 15, 2011, 1 page.
- Fried, "Live-blogging Steve Ballmer," CNET, ([http://www.cnet.com/8301-31045\\_1-10426723-269.html?tag=mncol%3btxt](http://www.cnet.com/8301-31045_1-10426723-269.html?tag=mncol%3btxt)), published Jan. 6, 2010, 6 pages.
- GSMarena.com. "Apple iPhone," ([http://www.gsmarena.com/apple\\_iphone-1827.php](http://www.gsmarena.com/apple_iphone-1827.php)), accessed Mar. 12, 2007, 3 pages.
- GSMarena.com, "LG KE850 Prada," ([http://www.gsmarena.com/lg\\_ke850\\_prada-1828.php](http://www.gsmarena.com/lg_ke850_prada-1828.php)), accessed Feb. 20, 2007, 4 pages.
- GSMarena.com, "Phillips S900," ([http://www.gsmarena.com/philips\\_s900-1598.php](http://www.gsmarena.com/philips_s900-1598.php)), accessed Feb. 20, 2007, 2 pages.
- GSMarena.com, "Samsung F700," ([http://www.gsmarena.com/samsung\\_f700-1849.php](http://www.gsmarena.com/samsung_f700-1849.php)), accessed Feb. 8, 2007, 2 pages.
- Hilon.com, "LG DMB MP3 FM35" (<http://www.hilon.com.cn/autobak/a88100055479.htm>), accessed Dec. 26, 2008, 18 pages.
- iF Design, "iF product design award 2007," ([http://www.ifdesign.de/beitragsdetails\\_e.html?offset=87&sprache=2&award\\_id=121&beit...](http://www.ifdesign.de/beitragsdetails_e.html?offset=87&sprache=2&award_id=121&beit...)), accessed on Sep. 21, 2011, 1 page.
- iriver.com, "iriver U-10," ([www.iriver.com](http://www.iriver.com)), published 2005, 2 pages.
- Itbusiness.ca, "Microsoft Mira eHome Wireless Smart Display," ([http://www.itbusiness.ca/images/articles/Jun10/clip\\_image003\\_0087.jpg](http://www.itbusiness.ca/images/articles/Jun10/clip_image003_0087.jpg)), accessed Nov. 15, 2011, 1 page.
- iTechNews.net, "Samsung K3 MP3 Player" (<http://www.itechnews.net/2006/12/02/samsung-k3-mp3-player/>), published Dec. 2, 2006, 9 pages.
- Justia, "*Applev. Samsung Electronics Co. Ltd. et al.*, Filing: 943 Attachment:5," (<http://docs.justia.com/cases/federal/district-courts/california/candce/5:2011cv01846/239768/943/5.html>), dated May 18, 2012, 3 pages.
- Kauffmann, "Music That Fits In Your Pocket," Tomsguide.com, (<http://www.tomsguide.com/us/music-that-fits-in-your-pocket,review-525-5.html>), published Aug. 25, 2005, 4 pages.
- Knowyourmobile.com, "LG KG800 technical specifications," ([http://www.knowyourmobile.com/lg/lgkg800chocolate/Igkg800reviews/137/lg\\_kg800\\_technical\\_specifications.html](http://www.knowyourmobile.com/lg/lgkg800chocolate/Igkg800reviews/137/lg_kg800_technical_specifications.html)), published Mar. 9, 2007, 3 pages.
- Lugmayr, "Sexy iHolic DMB TV PMP," (<http://www.i4u.com/11656/sexy-iholic-dmb-tv-pmp>), published Jan. 3, 2007, 1 page.
- McCracken, "The iPad. Of 2000. As Envisioned in 1988," Technologizer.com, (<http://technologizer.com/2010/05/14/the-ipad-of-2000-as-envisioned-in-1988/>), published May 14, 2010, 12 pages.
- Mel et al., "Tablet: Personal Computer in the Year 2000," *Communications of the ACM* 31:638-646, ACM (Jun. 1988).
- Mobilegazette.com, "Nokia N92," (<http://www.mobilegazette.com/nokia-n92-051102.htm>), published Nov. 2, 2005, 2 pages.
- Mobilewhack.com, "Tinnos PDA," ([http://www.mobilewhack.com/reviews/tinnos\\_pda.html](http://www.mobilewhack.com/reviews/tinnos_pda.html)), published May 19, 2006, 1 page.
- Needleman, "Hands-on with JooJoo," ([http://news.cnet.com/8301-19882\\_3-10410960-250.html](http://news.cnet.com/8301-19882_3-10410960-250.html)), CNET News, published Dec. 7, 2009, 31 pages.
- Newlaunches.com, "PIDION BM-200 sleek Windows CE PDA phone from Bluebird," ([http://www.newlaunches.com/archives/pidion\\_bm200\\_sleek\\_windows\\_ce\\_pda\\_phone\\_from\\_bluebird.php](http://www.newlaunches.com/archives/pidion_bm200_sleek_windows_ce_pda_phone_from_bluebird.php)), published Dec. 15, 2005, 3 pages.
- NYTimes.com "iRiver U10 (1GB)," (<http://www.nytimes.com/technology/personaltech/music-players/iRiver-U10-1GB-/31432102.html>), published Feb. 12, 2012, 2 pages.
- Patel, "The HP Slate" (<http://www.engadget.com/2010/01/06/the-hp-slate/>), Engadget.com, published Jan. 6, 2010, 4 pages.



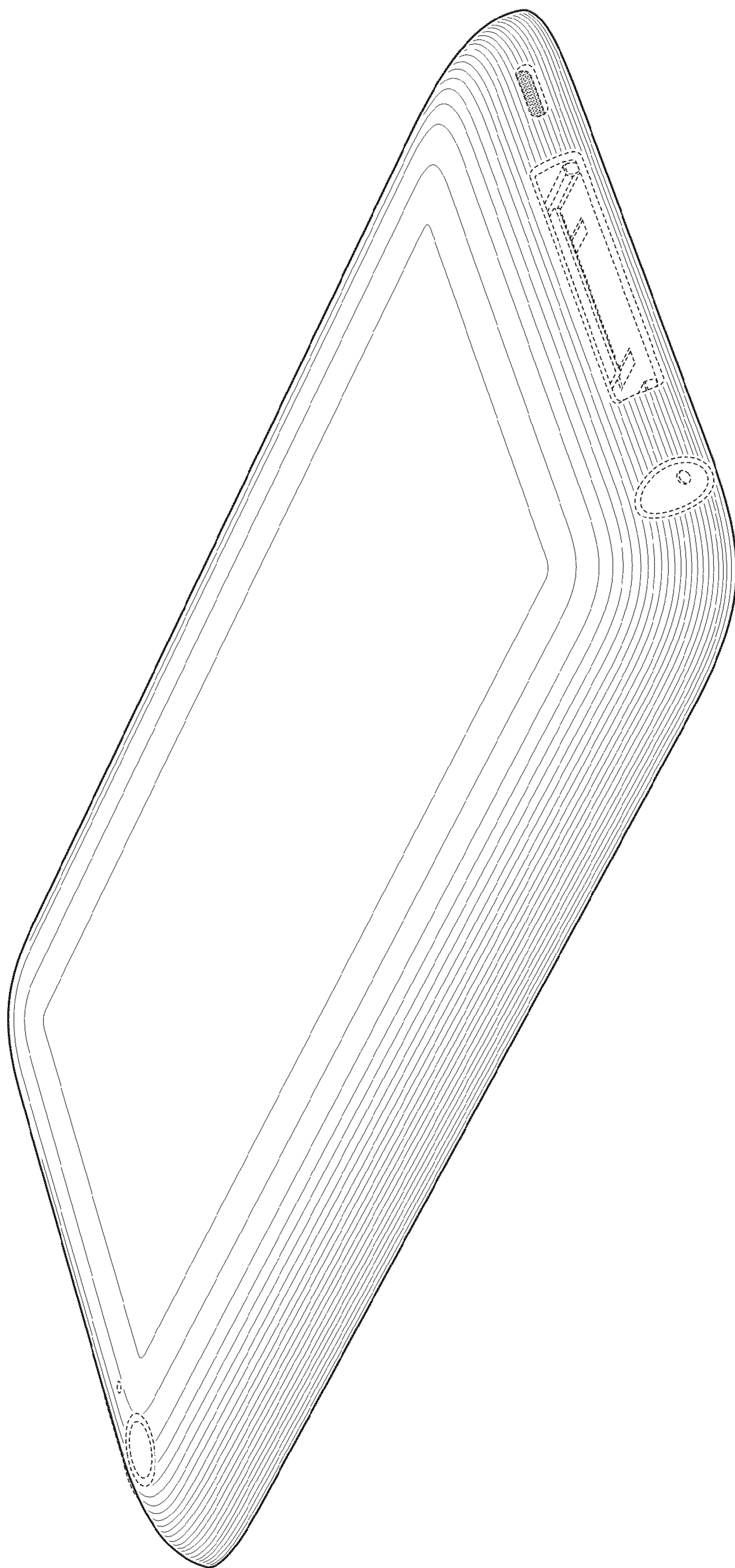
- PCMag.com, “iriver U10,” (<http://www.pcmag.com/article2/0,2817,1901833,00.asp>), published Dec. 14, 2005, 3 pages.
- PDADB.net, “Acer n20 Specs,” (<http://pdadb.net/index.php?m=specs&id=257&c=acem20>), published May 13, 2005, 3 pages.
- PDADB.net, “Bluebird Pidion BM-200 Specs,” ([http://pdadb.net/index.php?m=specs&id=1804&c=bluebird\\_pidion\\_bm-200](http://pdadb.net/index.php?m=specs&id=1804&c=bluebird_pidion_bm-200)), published Mar. 24, 2008, 3 pages.
- PDADB.net, “Casio Cassiopeia IT-10 M20BR Specs,” ([http://pdadb.net/index.php?m=specs&id=95&c=casio\\_cassiopeia\\_it-10\\_m20br](http://pdadb.net/index.php?m=specs&id=95&c=casio_cassiopeia_it-10_m20br)), published Dec. 30, 2004, 3 pages.
- PDADB.net, “CyberBank POZ X301 Specs,” ([http://pdadb.net/index.php?m=specs&id=442&c=cyber\\_poz\\_x301](http://pdadb.net/index.php?m=specs&id=442&c=cyber_poz_x301)), published Jan. 31, 2006, 3 pages.
- PDADB.net, “Dell Axim X3 Basic Specs” ([http://pdadb.net/index.php?m=specs&id=81&c=dell\\_axim\\_x3\\_basic](http://pdadb.net/index.php?m=specs&id=81&c=dell_axim_x3_basic)), published Dec. 30, 2004, 3 pages.
- PDADB.net, “Detailed Specifications of O2 XDA Flame” ([http://pdadb.net/index.php?m=specs&id=673&view=1&c=O2\\_xda\\_flame](http://pdadb.net/index.php?m=specs&id=673&view=1&c=O2_xda_flame)), accessed May 6, 2011, 3 pages.
- PDADB.net, “Dopod 838 Pro (HTC Hermes 100) Specs,” ([http://pdadb.net/index.php?m=specs&id=578&c=dopod\\_838\\_pro\\_htc\\_hermes\\_100](http://pdadb.net/index.php?m=specs&id=578&c=dopod_838_pro_htc_hermes_100)), published Aug. 4, 2005, 3 pages.
- PDADB.net, “Garmin iQue M5 Specs,” ([http://pdadb.net/index.php?m=specs&id=302&c=garmin\\_ique\\_m5](http://pdadb.net/index.php?m=specs&id=302&c=garmin_ique_m5)), published Jul. 17, 2005, 3 pages.
- PDADB.net, “Krome Spy (HTC Magician Refresh) Specs,” ([http://pdadb.net/index.php?m=specs&id=550&c=krome\\_spy\\_htc\\_magician\\_refresh](http://pdadb.net/index.php?m=specs&id=550&c=krome_spy_htc_magician_refresh)), published Jul. 18, 2006, 3 pages.
- PDADB.net, “MiTAC Mio 338 Plus Digi-Walker Specs,” ([http://pdadb.net/index.php?m=specs&id=60&c=mitac\\_mio\\_338\\_plus\\_digi-walker](http://pdadb.net/index.php?m=specs&id=60&c=mitac_mio_338_plus_digi-walker)), published Dec. 25, 2004, 3 pages.
- PDADB.net, “O2 XDA (HTC Wallaby) Specs,” ([http://pdadb.net/index.php?m=specs&id=117&c=o2\\_xda\\_htc\\_wallaby](http://pdadb.net/index.php?m=specs&id=117&c=o2_xda_htc_wallaby)), published Feb. 3, 2005, 3 pages.
- PDADB.net, “Palm Z22 Specs,” ([http://pdadb.net/index.php?m=specs&id=1244&c=palm\\_z22](http://pdadb.net/index.php?m=specs&id=1244&c=palm_z22)), published Mar. 13, 2006, 3 pages.
- PDADB.net, “PalmOne LifeDrive Specs,” ([http://pdadb.net/index.php?m=specs&id=1242&c=palmone\\_lifedrive](http://pdadb.net/index.php?m=specs&id=1242&c=palmone_lifedrive)), published Mar. 12, 2008, 3 pages.
- PDADB.net, “Sony Clie PEG-SL10 / PEG-SL10U / PEG-SL10E Specs,” ([http://pdadb.net/index.php?m=specs&id=1198&c=sony\\_clie\\_peg-sl10\\_peg-sl10u\\_peg-sl10e](http://pdadb.net/index.php?m=specs&id=1198&c=sony_clie_peg-sl10_peg-sl10u_peg-sl10e)), published Mar. 4, 2008, 3 pages.
- PDADB.net, “Sony Clie PEG-T665C / PEG-T675C Specs,” ([http://pdadb.net/index.php?m=specs&id=1192&c=sony\\_clie\\_peg-t665c\\_peg-t675c](http://pdadb.net/index.php?m=specs&id=1192&c=sony_clie_peg-t665c_peg-t675c)), published Mar. 4, 2008, 3 pages. PDADB.net, “Toshiba Genio e330 Specs,”
- PDADB.net, “Toshiba Genio e330 Specs,” ([http://pdadb.net/index.php?rn=specs&id=29&c=toshiba\\_genio\\_e330](http://pdadb.net/index.php?rn=specs&id=29&c=toshiba_genio_e330)), published Dec. 9, 2004, 3 pages.
- PDADB.net, “Toshiba Genio e570 Specs,” ([http://pdadb.net/index.php?m=specs&id=229&c=toshiba\\_genio\\_e570](http://pdadb.net/index.php?m=specs&id=229&c=toshiba_genio_e570)), published May 4, 2006, 3 pages.
- Ricker, “LG’s KE850 PRADA official: iPhone says, wha?” Engadget.com, (<http://www.engadget.com/2007/01/18/lgs-ke850-prada-official-iphone-says-wha/>), published Jan. 18, 2007, 4 pages.
- Ricker, “Meizu’s M8? Apple lawyers, start your engines,” Engadget.com, (<http://www.engadget.com/2007/01/29/meizus-m8-apple-lawyers-start-your-engines/>), published Jan. 29, 2007, 1 page.
- Ricker, “The Pidion BM-200: it’s time to move to Seoul,” (<http://www.engadget.com/2005/10/04/the-pidion-bm-200-its-time-to-move-to-seoul/>), Engadget.com, published Oct. 4, 2005, 4 pages.
- Rojas, “Hands-on with the Nokia N92,” Engadget.com, (<http://www.engadget.com/2005/12/01/hands-on-with-the-nokia-n92/>), published Dec. 1, 2005, 4 pages.
- S. Dimitris, “Pidion BM200 Smartphone,” PDASNews, ([www.pdasnews.com/articles/pidion-bm200-smartphone.html](http://www.pdasnews.com/articles/pidion-bm200-smartphone.html)), accessed Mar. 7, 2012, 2 pages.
- Salesstores.com, “LG L1530TM Tablet LCD Monitor,” (<http://salesstores.com/lgl1talcdmos.html>), accessed Nov. 17, 2011, 2 pages.
- Smith et al., “The Radical Scroll Tool: Scrolling Support for Stylus- or Touch-Based Document Navigation,” *UIST*, ACM, published Oct. 2004.
- Smith, reghardware.com, “First fondleslab found in 1970s kids TV sci-fi gem: Apple iPad inspired by Tomorrow People,” ([http://www.reghardware.com/2011/02/07/apple\\_ipad\\_tomorrow\\_people/](http://www.reghardware.com/2011/02/07/apple_ipad_tomorrow_people/)), published Feb. 7, 2011, 3 pages.
- Sooman, “The LG Chocolate phone,” Techspot.com, (<http://www.techspot.com/news/20929-the-lg-chocolate-phone.html>), published on Mar. 23, 2006, 5 pages.
- Vilas-Boas, “Industrial Design Portfolio,” published 2004, 6 pages.
- WebdesignerDepot.com, “The Evolution of Cell Phone Design Between 1983-2009” (<http://www.webdesignerdepot.com/2009/05/the-evolution-of-cell-phone-design-between-1983-2009/>), accessed May 6, 2011, 56 pages.
- Wikipedia.org, “CLIE,” (<http://en.wikipedia.org/wiki/CLIE>), last modified Feb. 12, 2011, 3 pages.
- Wikipedia.org, “E-Ten” (<http://en.wikipedia.org/wiki/E-TEN>), last modified Dec. 15, 2010, 2 pages.
- Wikipedia.org, “File:LG KE850 Prada Hauptmenü.jpg,” ([http://en.wikipedia.org/wiki/File:LG\\_KE850\\_Prada\\_Hauptmen%C3%BCjpg](http://en.wikipedia.org/wiki/File:LG_KE850_Prada_Hauptmen%C3%BCjpg)), accessed Feb. 12, 2012, 4 pages.
- Wikipedia.org, “iPAQ” (<http://en.wikipedia.org/wiki/IPAQ>), last modified May 4, 2011, 7 pages.
- Wikipedia.org, “LifeDrive” (<http://en.wikipedia.org/wiki/LifeDrive>), last modified Mar. 16, 2011, 3 pages.
- Wikipedia.org, “Pocket viewer,” ([http://en.wikipedia.org/wiki/Pocket\\_viewer](http://en.wikipedia.org/wiki/Pocket_viewer)), last modified Apr. 10, 2011, 4 pages.
- Wikipedia.org, “Zire Handheld” ([http://en.wikipedia.org/wiki/Zire\\_Handheld](http://en.wikipedia.org/wiki/Zire_Handheld)), last modified Dec. 11, 2010, 4 pages.
- Ziegler, “The LG KE850: touchable chocolate,” Engadget.com, (<http://www.engadget.com/2006/12/15/the-lg-ke850-touchable-chocolate/>), published Dec. 15, 2006, 5 pages.

\* cited by examiner



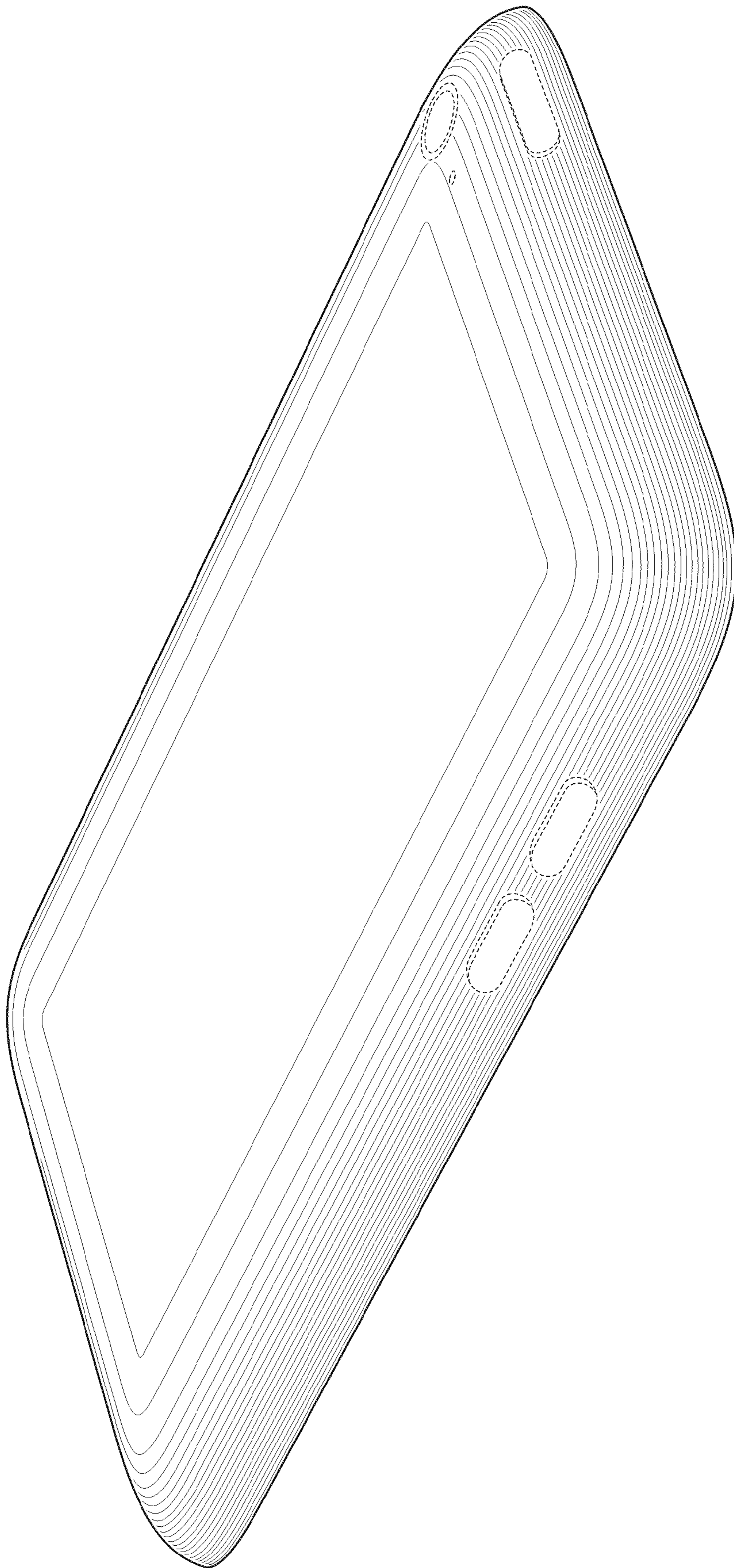
**FIG. 1**





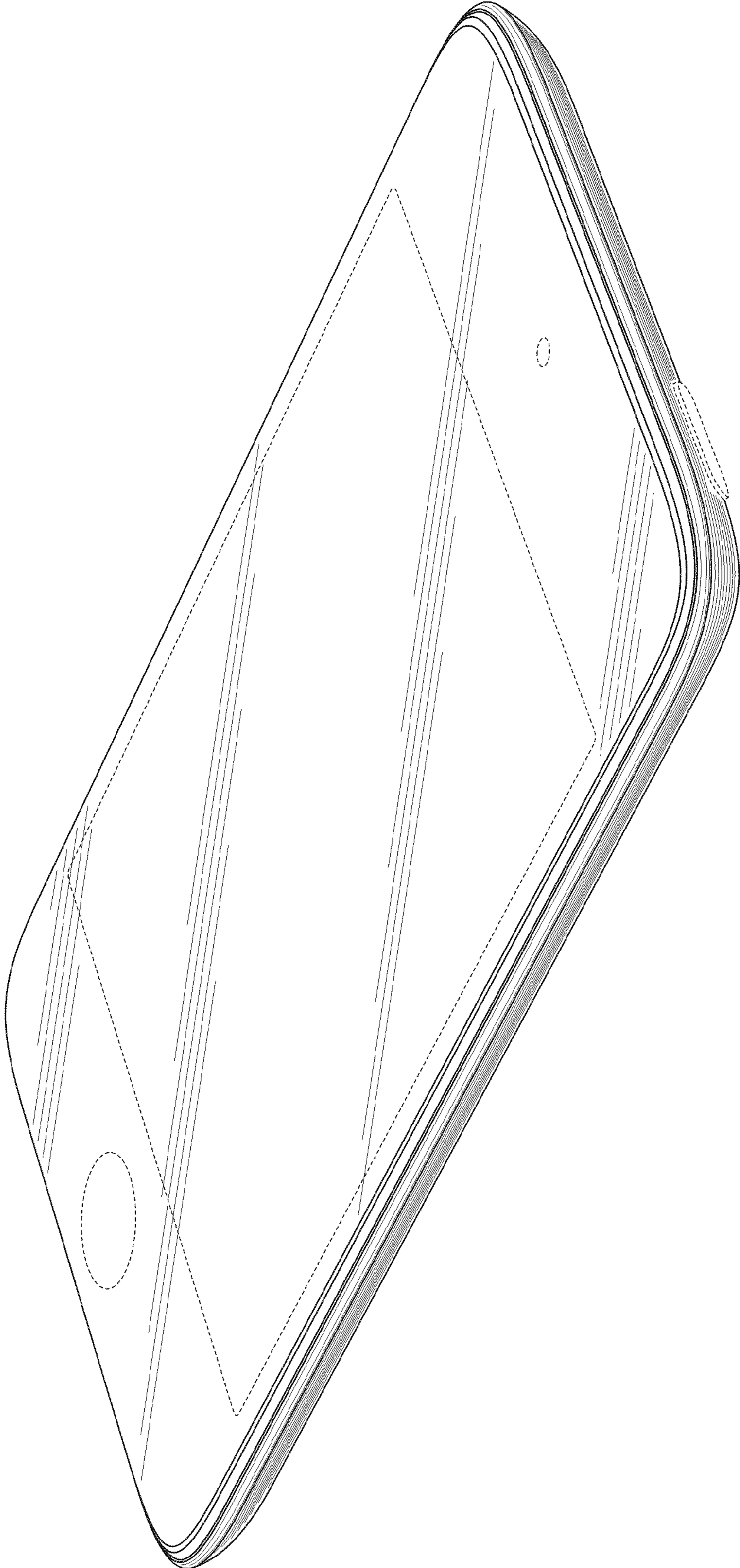
**FIG. 2**





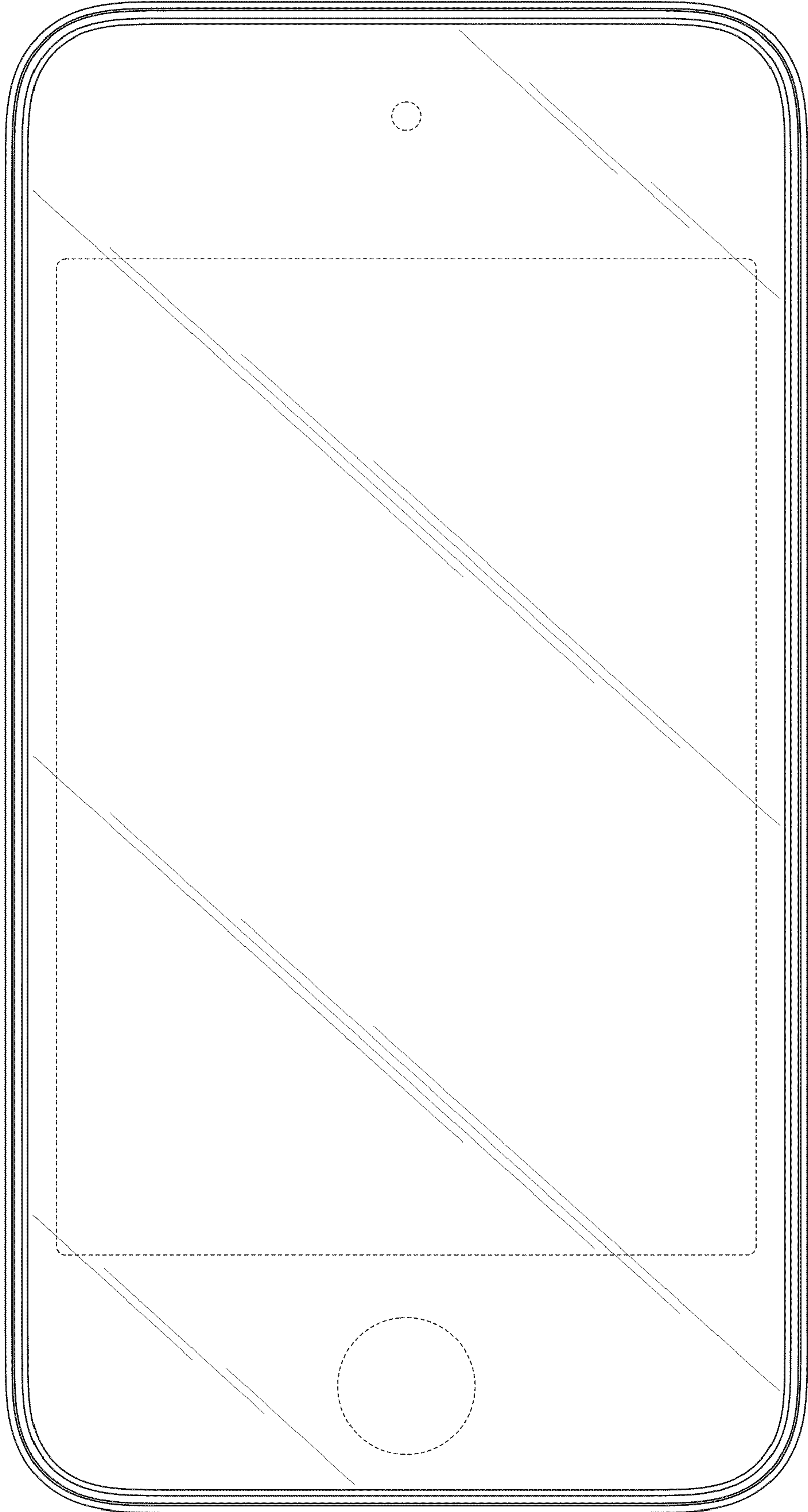
**FIG. 3**





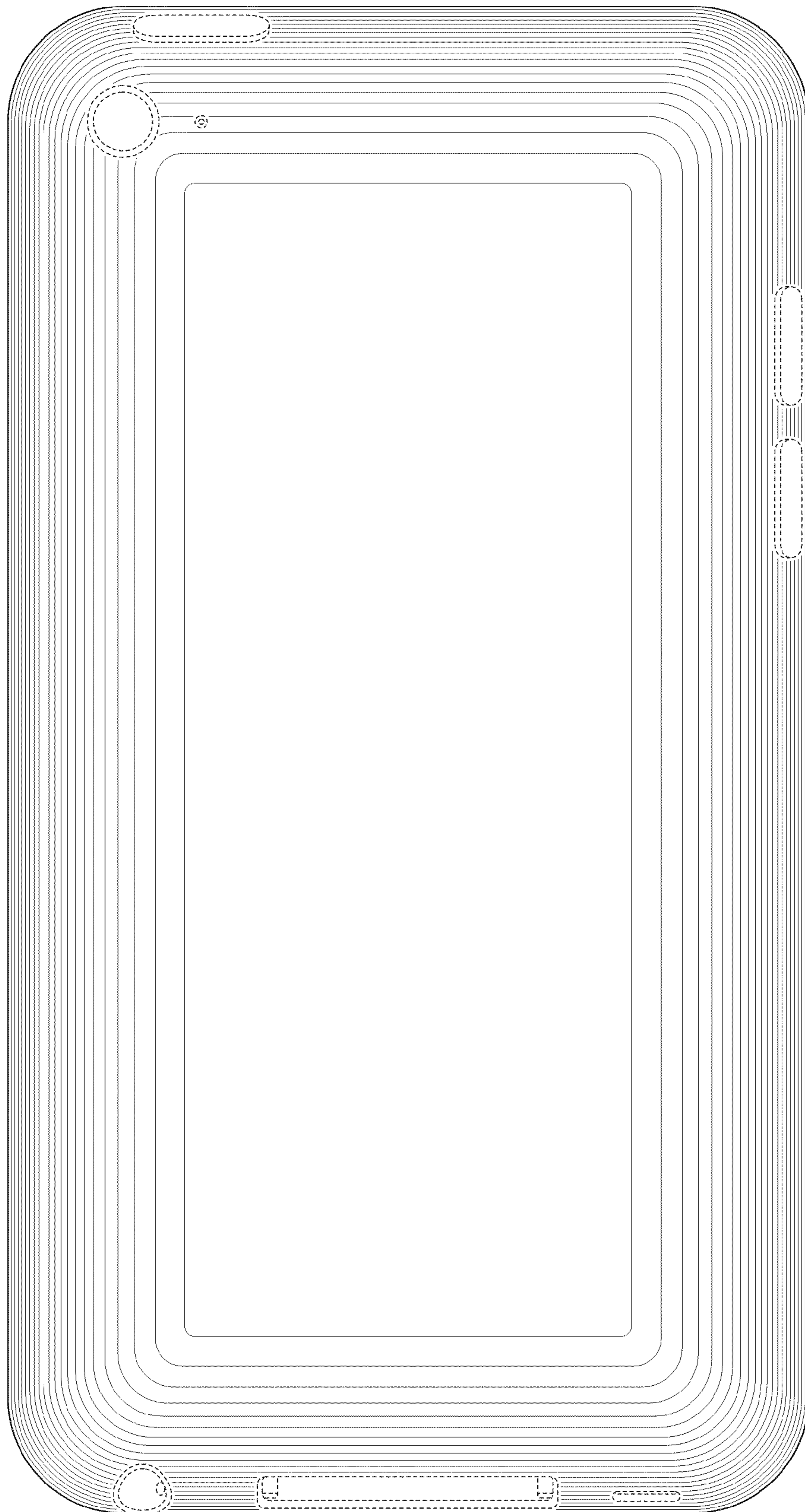
**FIG. 4**





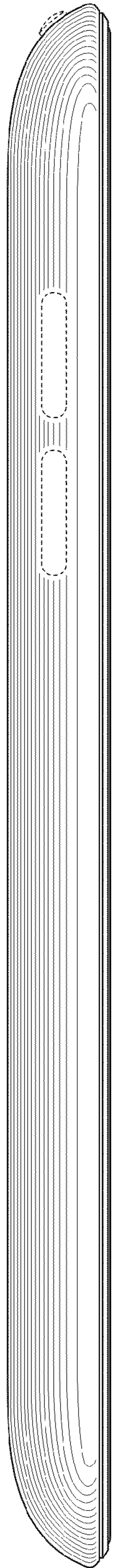
**FIG. 5**



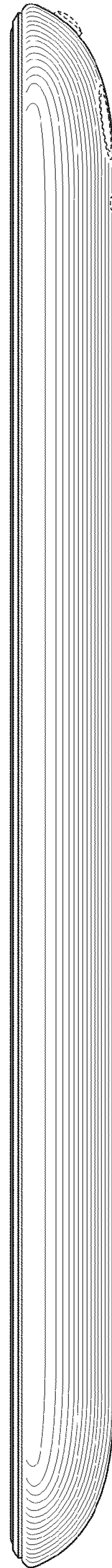


**FIG. 6**

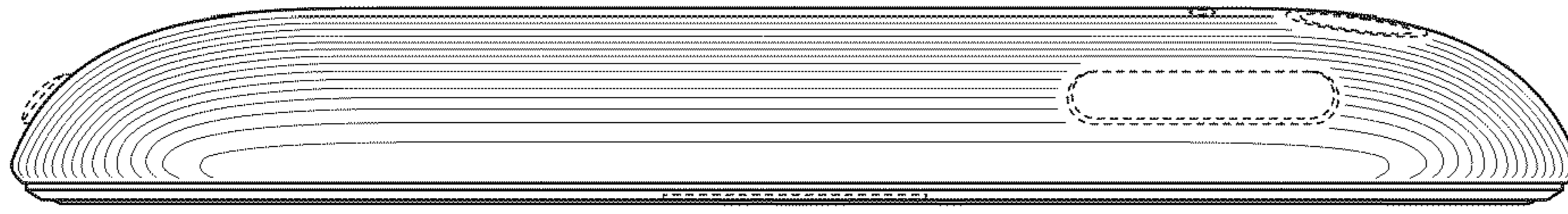




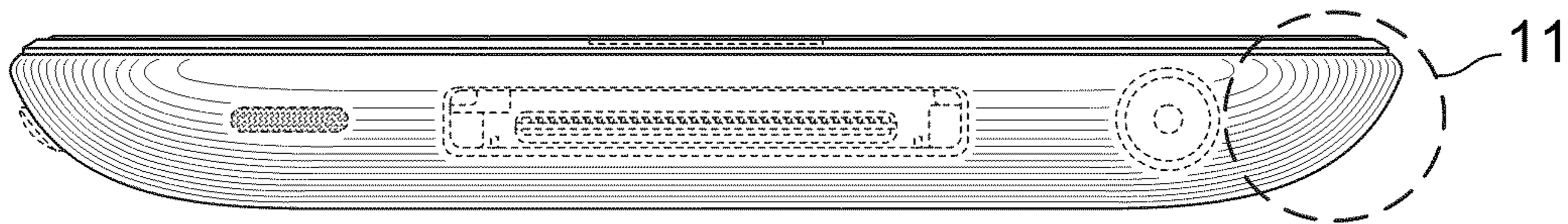
**FIG. 7**



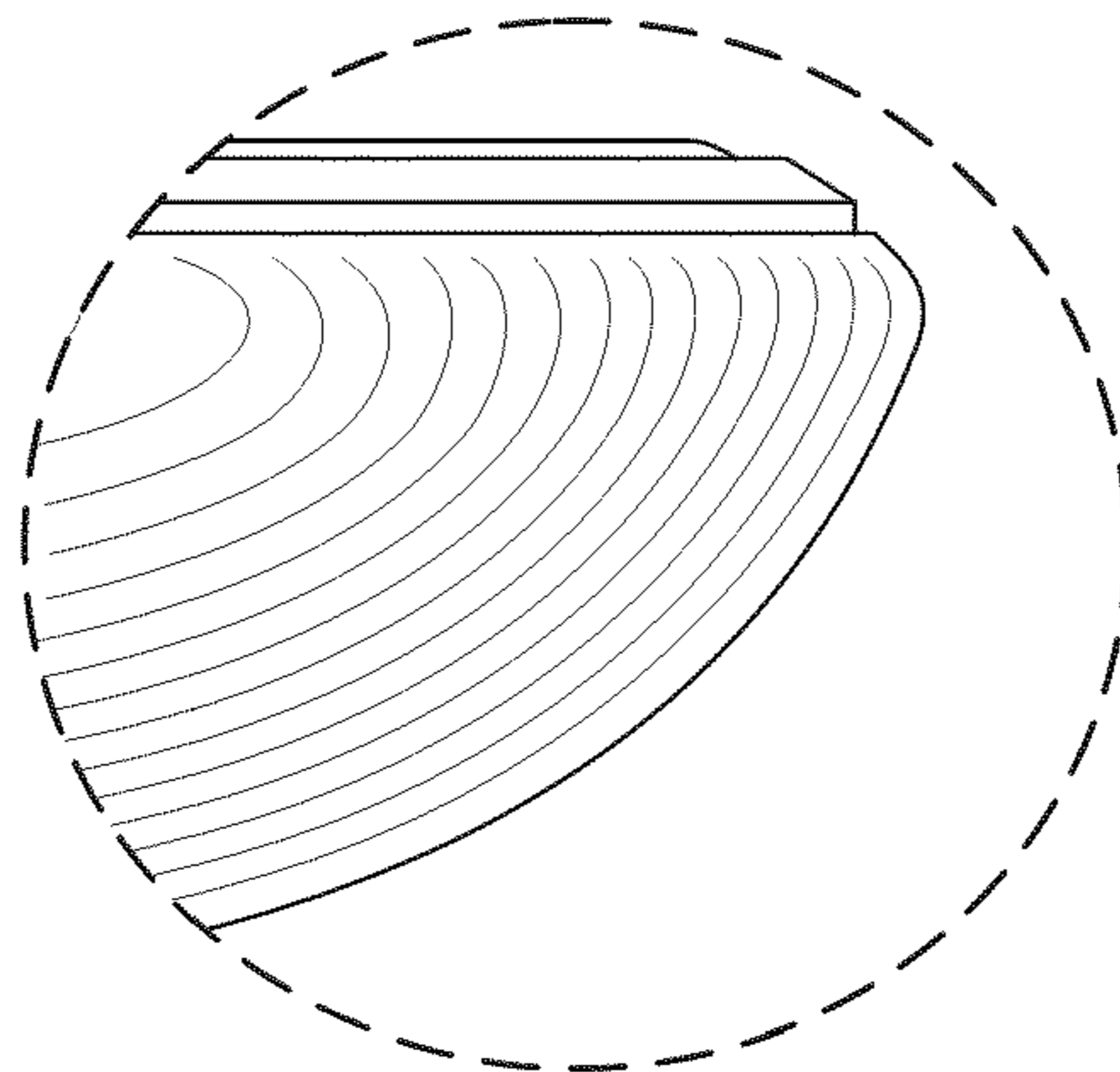
**FIG. 8**



**FIG. 9**



**FIG. 10**



**FIG. 11**