



US00D673070S

(12) **United States Design Patent**
Papadimitriou

(10) **Patent No.:** **US D673,070 S**

(45) **Date of Patent:** **** Dec. 25, 2012**

(54) **EARRING**

(75) Inventor: **Costantino Papadimitriou**, Milan (IT)

(73) Assignee: **De Beers Centenary AG**, Luzern (CH)

(**) Term: **14 Years**

(21) Appl. No.: **29/419,266**

(22) Filed: **Apr. 26, 2012**

Related U.S. Application Data

(62) Division of application No. 29/400,855, filed on Sep. 1, 2011, now Pat. No. Des. 661,219.

(30) **Foreign Application Priority Data**

Mar. 4, 2011 (EM) 001831181
Mar. 4, 2011 (EM) 001831280

(51) **LOC (9) Cl.** **11-01**

(52) **U.S. Cl.** **D11/43; D11/79**

(58) **Field of Classification Search** D11/79-85,
D11/89-91, 40-48, 1-8; 63/26-28, 12-14,
63/3, 3.1, 3.2

See application file for complete search history.

(56) **References Cited**

U.S. PATENT DOCUMENTS

D19,102 S * 5/1889 Stayner D11/79
(Continued)

Primary Examiner — Cathron Brooks

Assistant Examiner — Melanie Pellegrini

(74) *Attorney, Agent, or Firm* — SNR Denton US LLP;
Brian R. McGinley

(57) **CLAIM**

The ornamental design for an earring, as shown and described.

DESCRIPTION

FIG. 1 is a top view of a first embodiment of the earring; FIG. 2 is a bottom view of the earring illustrated in FIG. 1; FIG. 3 is a right elevational view of the earring illustrated in FIG. 1; FIG. 4 is a left elevational view of the earring illustrated in FIG. 1; FIG. 5 is a front view of the earring illustrated in FIG. 1; FIG. 6 is a rear view of the earring illustrated in FIG. 1; FIG. 7 is a perspective view of the earring illustrated in FIG. 1

FIG. 8 is a top view of a second embodiment of the earring; FIG. 9 is a bottom view of the earring illustrated in FIG. 8; FIG. 10 is a right elevational view of the earring illustrated in FIG. 8; FIG. 11 is a left elevational view of the earring illustrated in FIG. 8; FIG. 12 is a front view of the earring illustrated in FIG. 8; FIG. 13 is a rear view of the earring illustrated in FIG. 8; FIG. 14 is a perspective view of the earring illustrated in FIG. 8

FIG. 15 is a top view of a third embodiment of the earring; FIG. 16 is a bottom view of the earring illustrated in FIG. 15; FIG. 17 is a right elevational view of the earring illustrated in FIG. 15; FIG. 18 is a left elevational view of the earring illustrated in FIG. 15; FIG. 19 is a front view of the earring illustrated in FIG. 15; FIG. 20 is a rear view of the earring illustrated in FIG. 15; FIG. 21 is a perspective view of the earring illustrated in FIG. 15;

FIG. 22 is a top view of a fourth embodiment of the earring; FIG. 23 is a bottom view of the earring illustrated in FIG. 22; FIG. 24 is a right elevational view of the earring illustrated in FIG. 22; FIG. 25 is a left elevational view of the earring illustrated in FIG. 22; FIG. 26 is a front view of the earring illustrated in FIG. 22; FIG. 27 is a rear view of the earring illustrated in FIG. 22; and, FIG. 28 is a perspective view of the earring illustrated in FIG. 22.

1 Claim, 24 Drawing Sheets

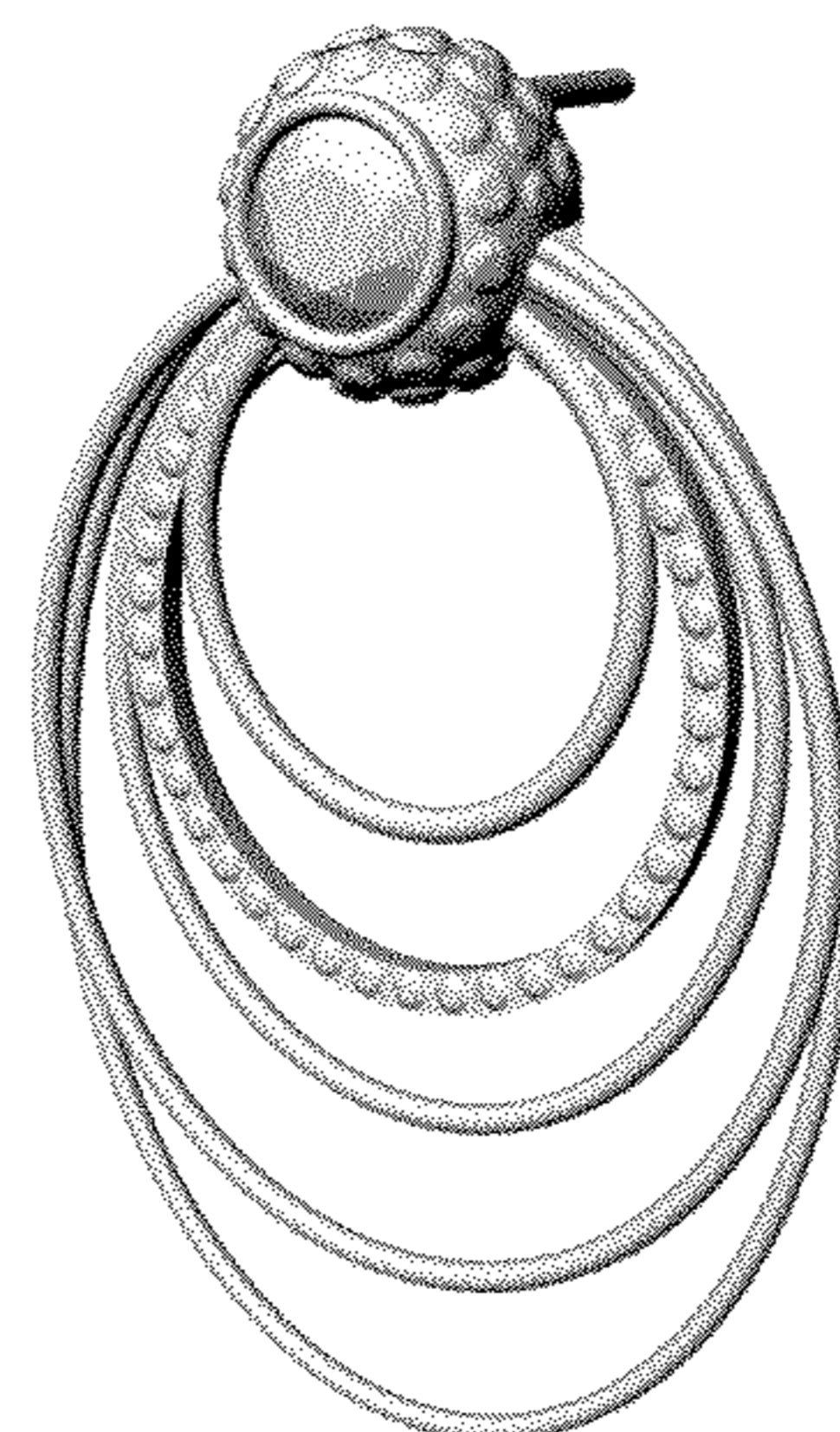
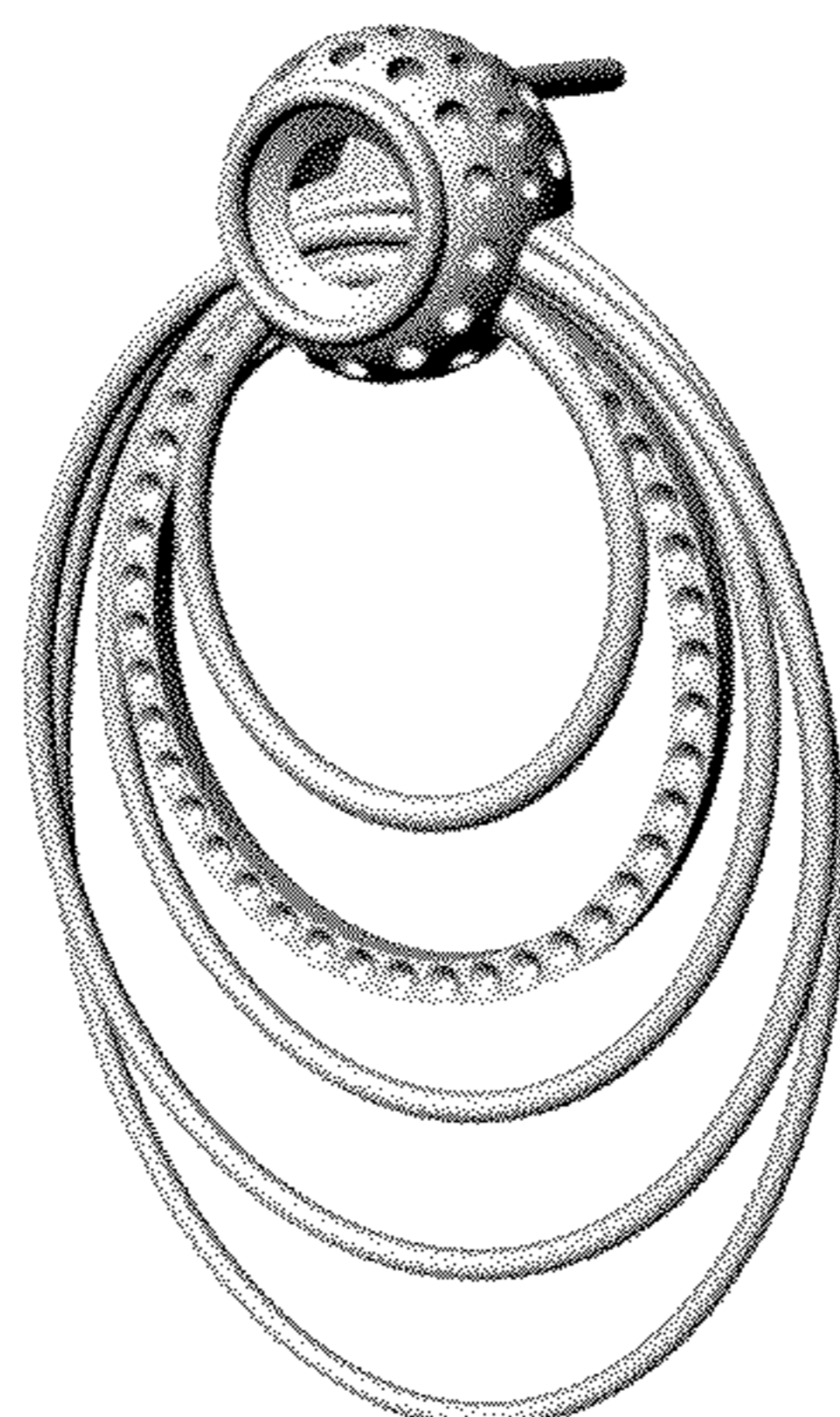

US D673,070 S

Page 2

U.S. PATENT DOCUMENTS

D32,246	S	*	2/1900	Bigney	D11/79	7,121,117	B2	*	10/2006	Gruosi-Scheufele	63/1.14
D40,581	S	*	3/1910	Finberg	D11/4	D533,479	S	*	12/2006	Dubnicka	D11/91
1,732,250	A	*	10/1929	Wehse	63/14.2	D542,696	S	*	5/2007	Cilluffo	D11/40
D114,212	S	*	4/1939	Graeter	D11/48	D586,685	S	*	2/2009	Grassi Damiani	D11/16
D138,956	S	*	10/1944	Karples	D11/75	D597,435	S	*	8/2009	Gruosi	D11/4
D148,172	S	*	12/1947	Katz	D11/75	D625,640	S	*	10/2010	Sivriere	D11/1
D164,946	S	*	10/1951	Trifarri et al.	D11/45	D636,696	S	*	4/2011	Lebail	D11/43
D248,380	S	*	7/1978	Burchett	D11/43	D637,103	S	*	5/2011	Lebail	D11/43
D260,140	S	*	8/1981	Bicenko	D11/79	D658,090	S	*	4/2012	Papadimitriou	D11/43
D308,348	S	*	6/1990	Leopoldi	D11/43	D659,583	S	*	5/2012	Papadimitriou	D11/43
D408,316	S	*	4/1999	Perrin et al.	D11/47	D661,219	S	*	6/2012	Papadimitriou	D11/43
D455,097	S	*	4/2002	Salvarani	D11/79	D661,220	S	*	6/2012	Papadimitriou	D11/79
6,688,507	B2	*	2/2004	McCormack	24/3.3	D664,061	S	*	7/2012	Papadimitriou	D11/43
D489,024	S	*	4/2004	Beber et al.	D11/91	D664,062	S	*	7/2012	Papadimitriou	D11/43
D497,322	S	*	10/2004	Gruosi-Scheufele	D11/79							

* cited by examiner

FIG. 1

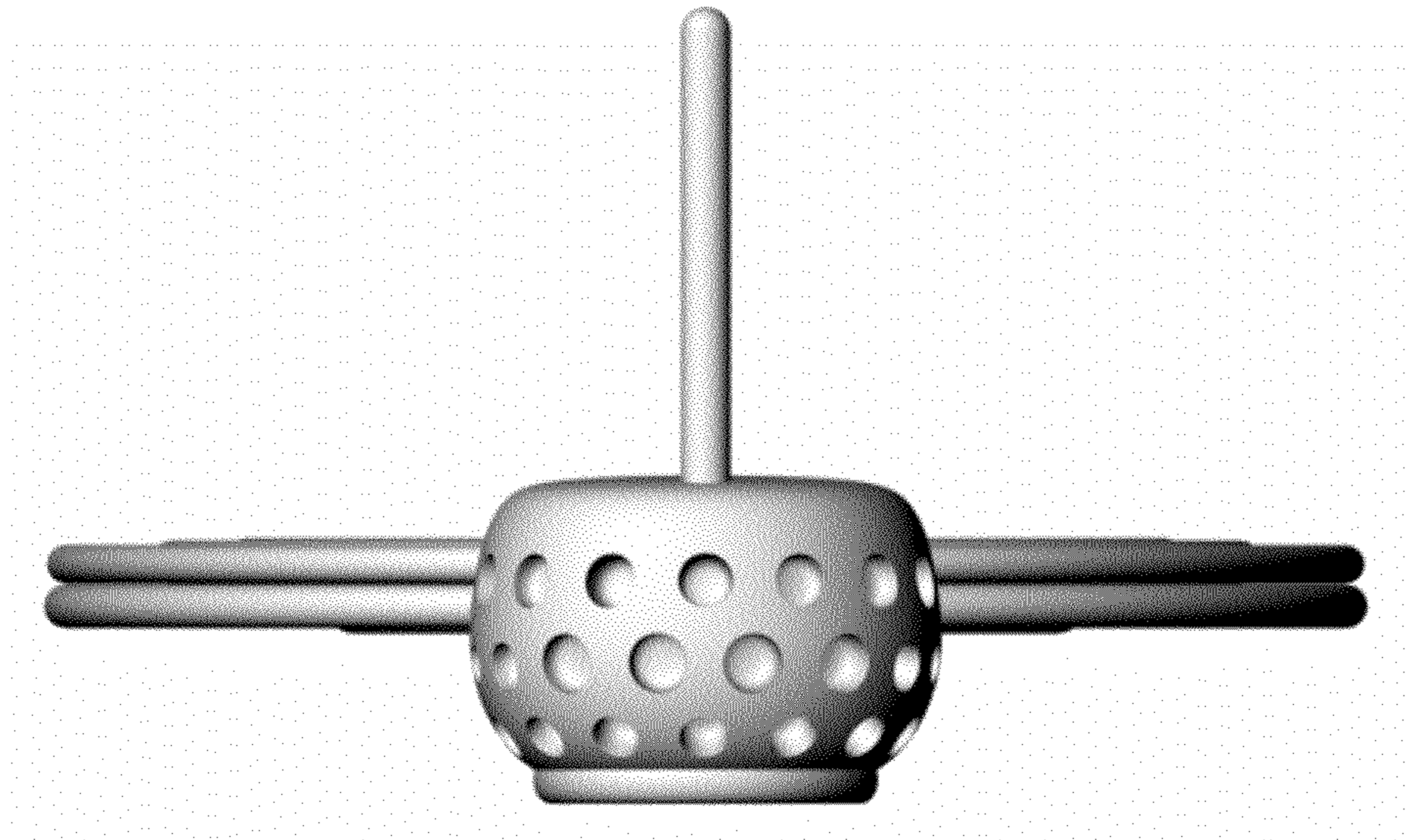

FIG. 2

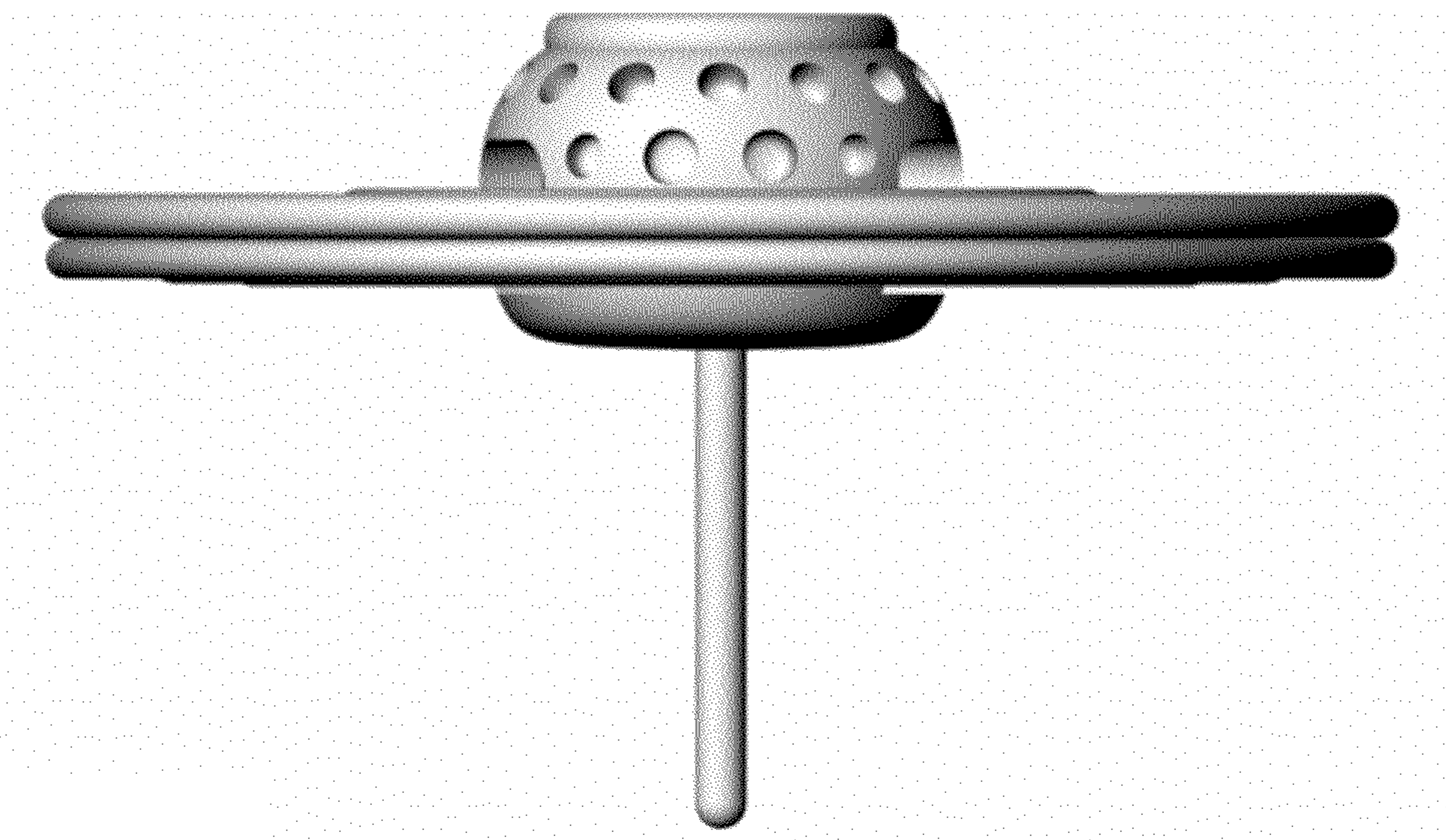

FIG. 3



FIG. 4

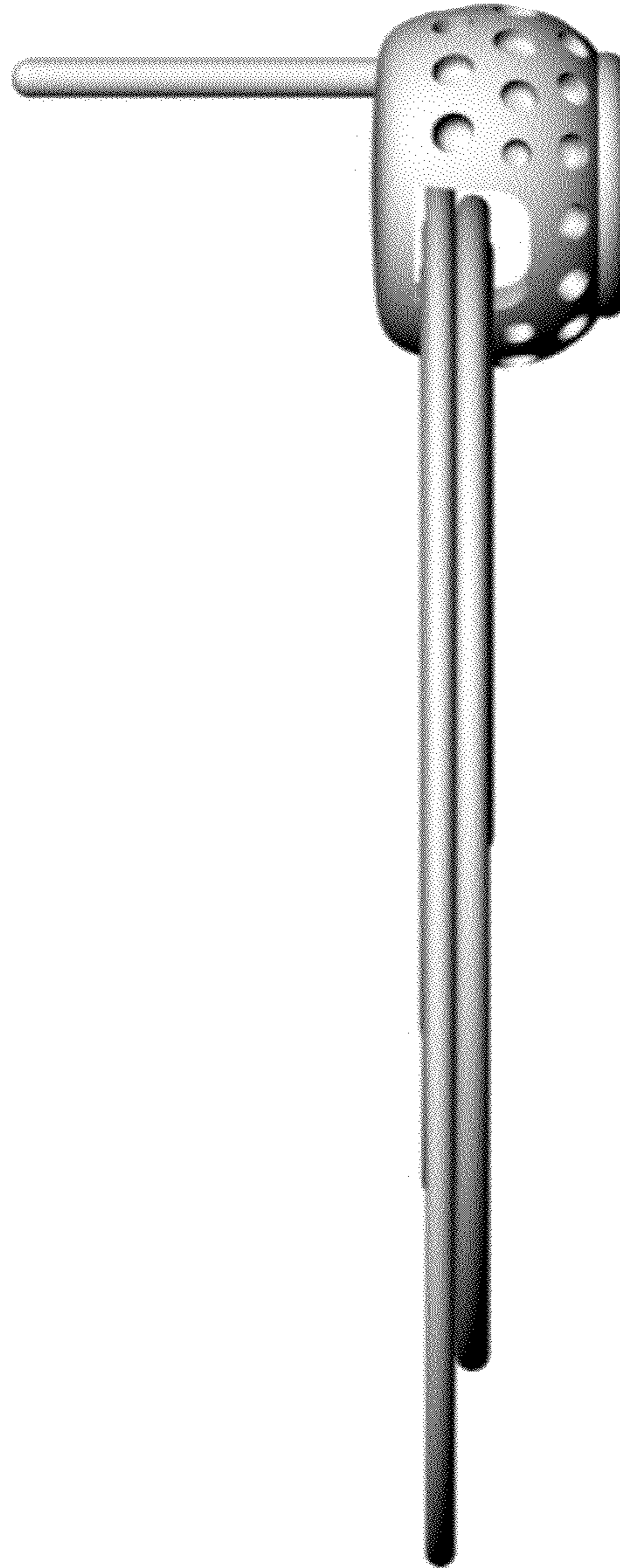

FIG. 5



FIG. 6

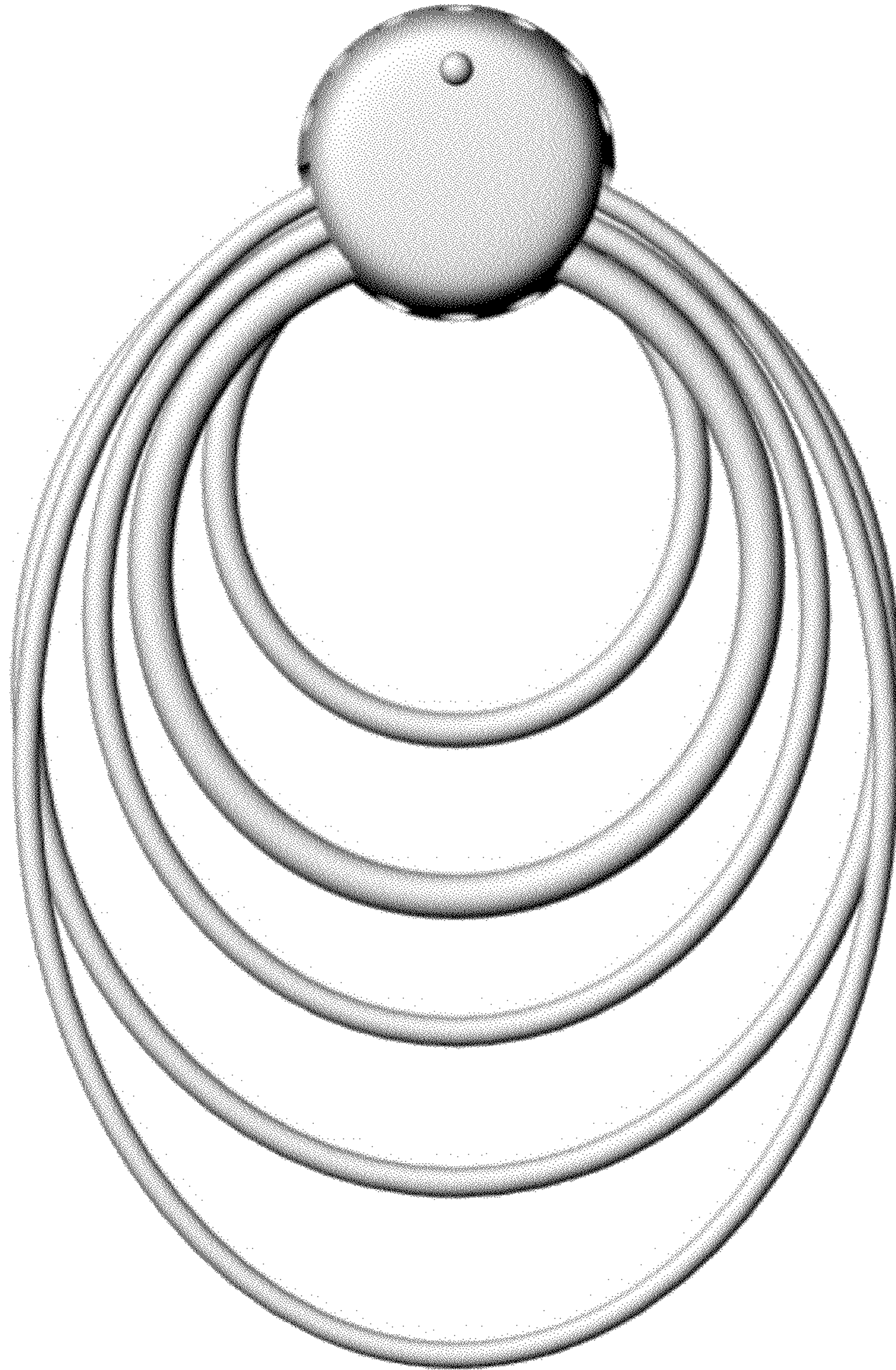

FIG. 7



FIG. 8

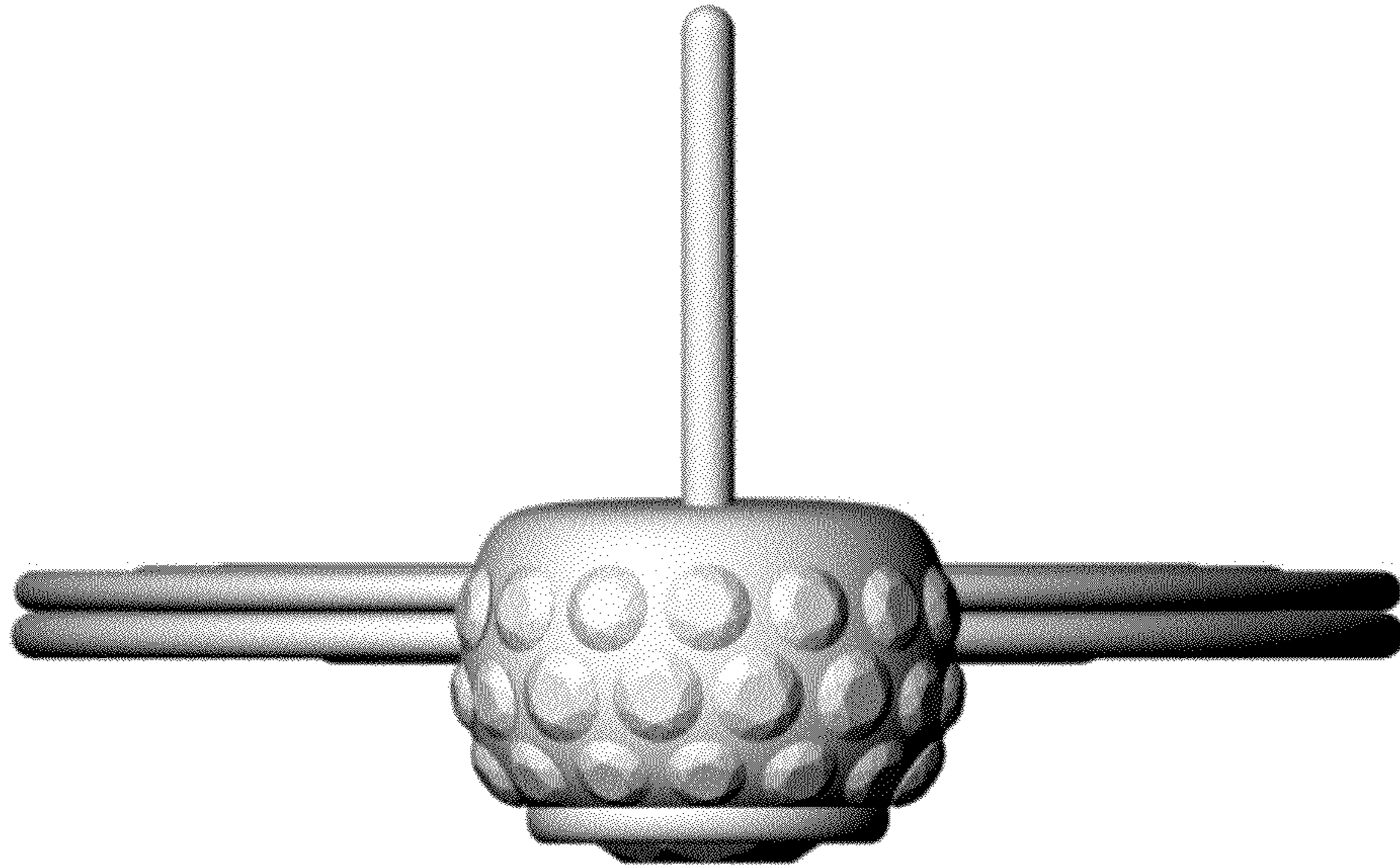

FIG. 9

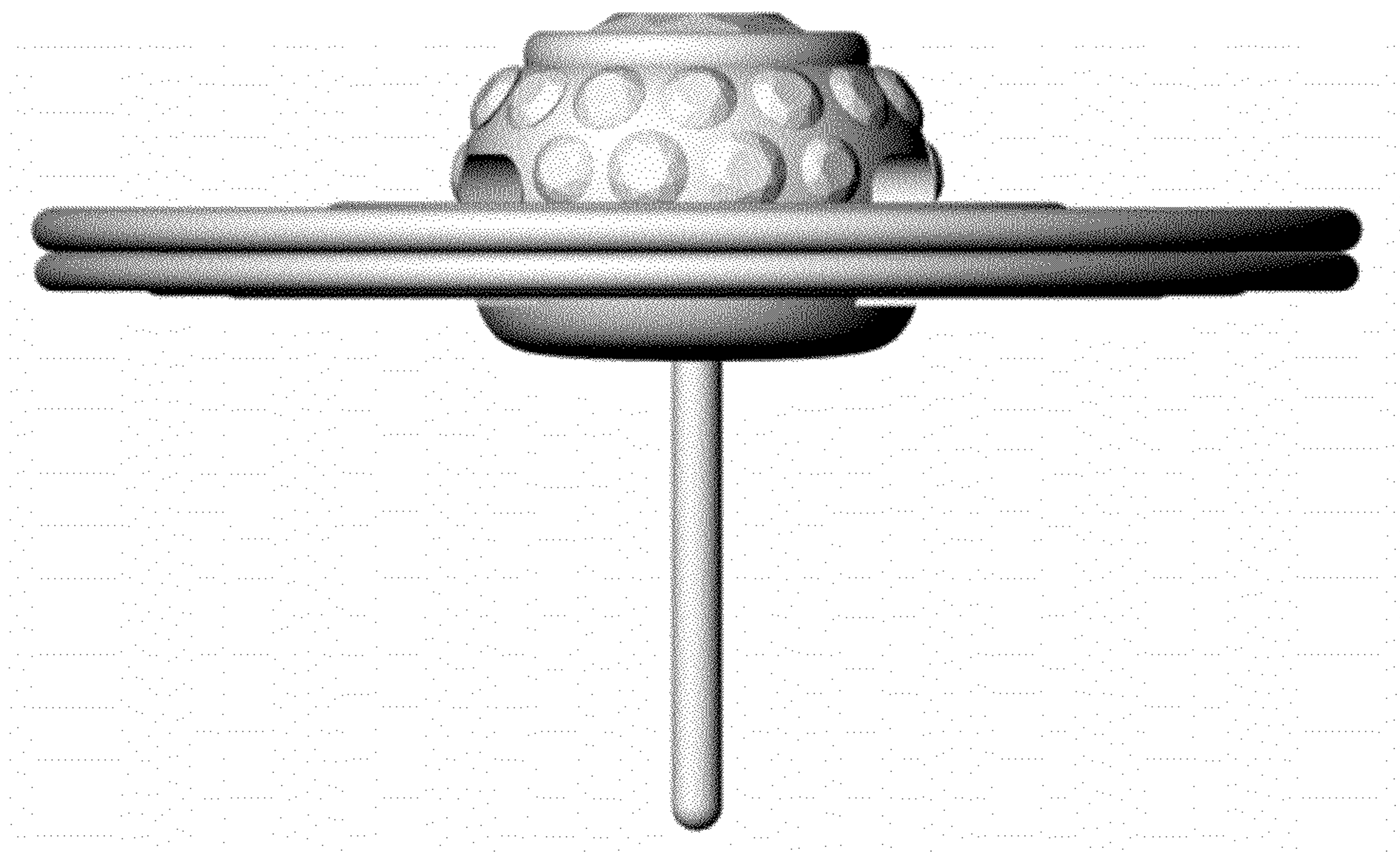

FIG. 10

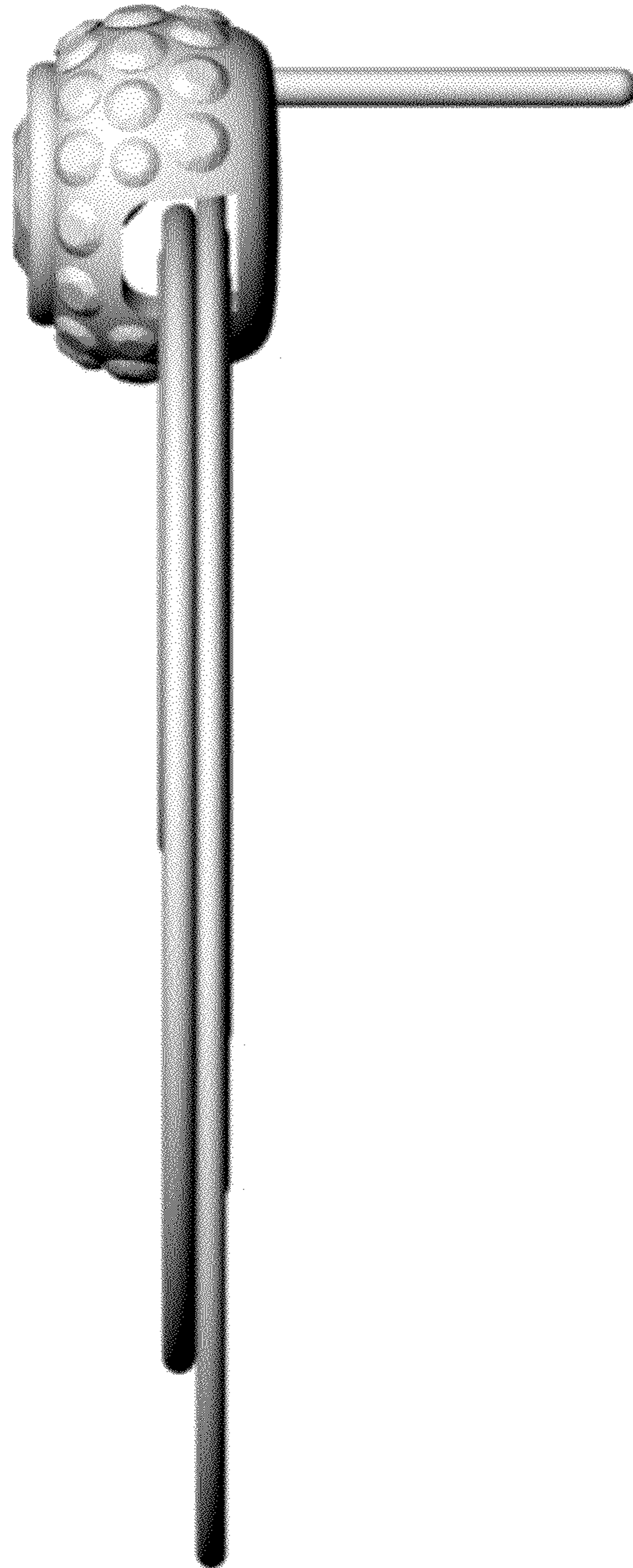

FIG. 11

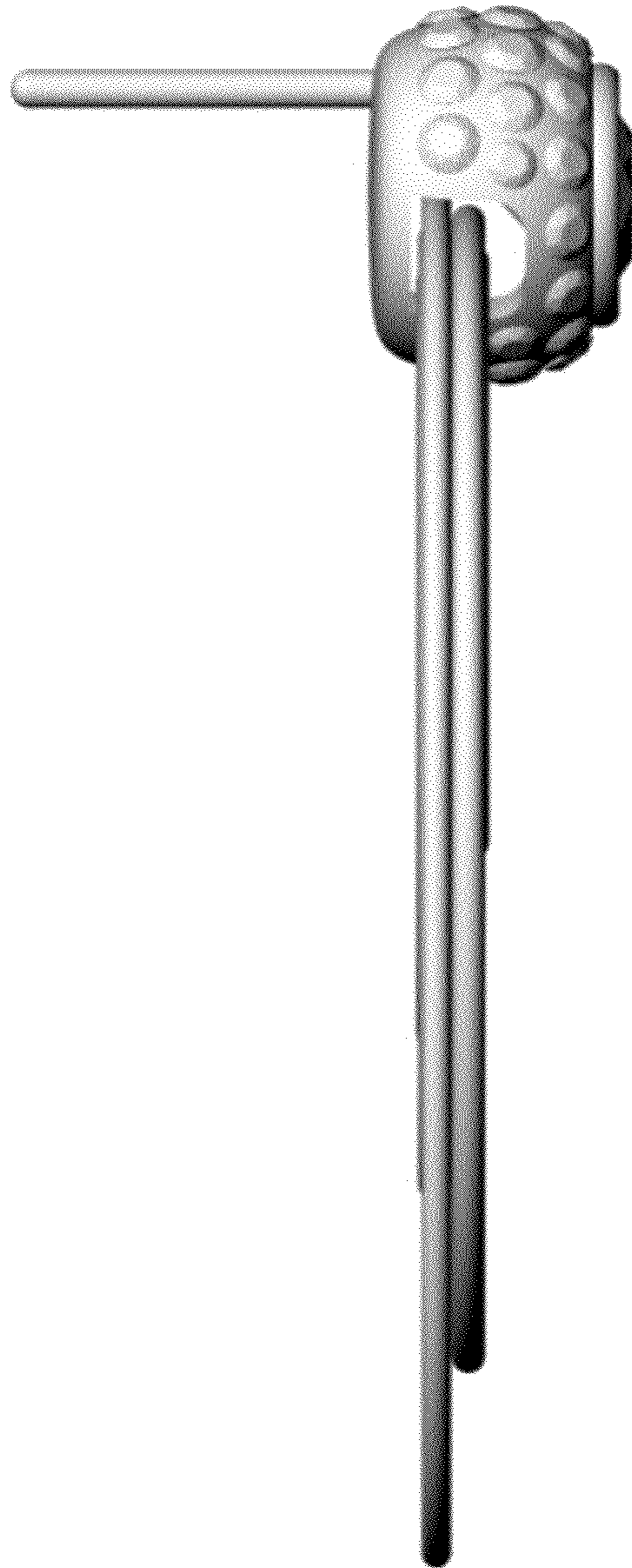

FIG. 12



FIG. 13

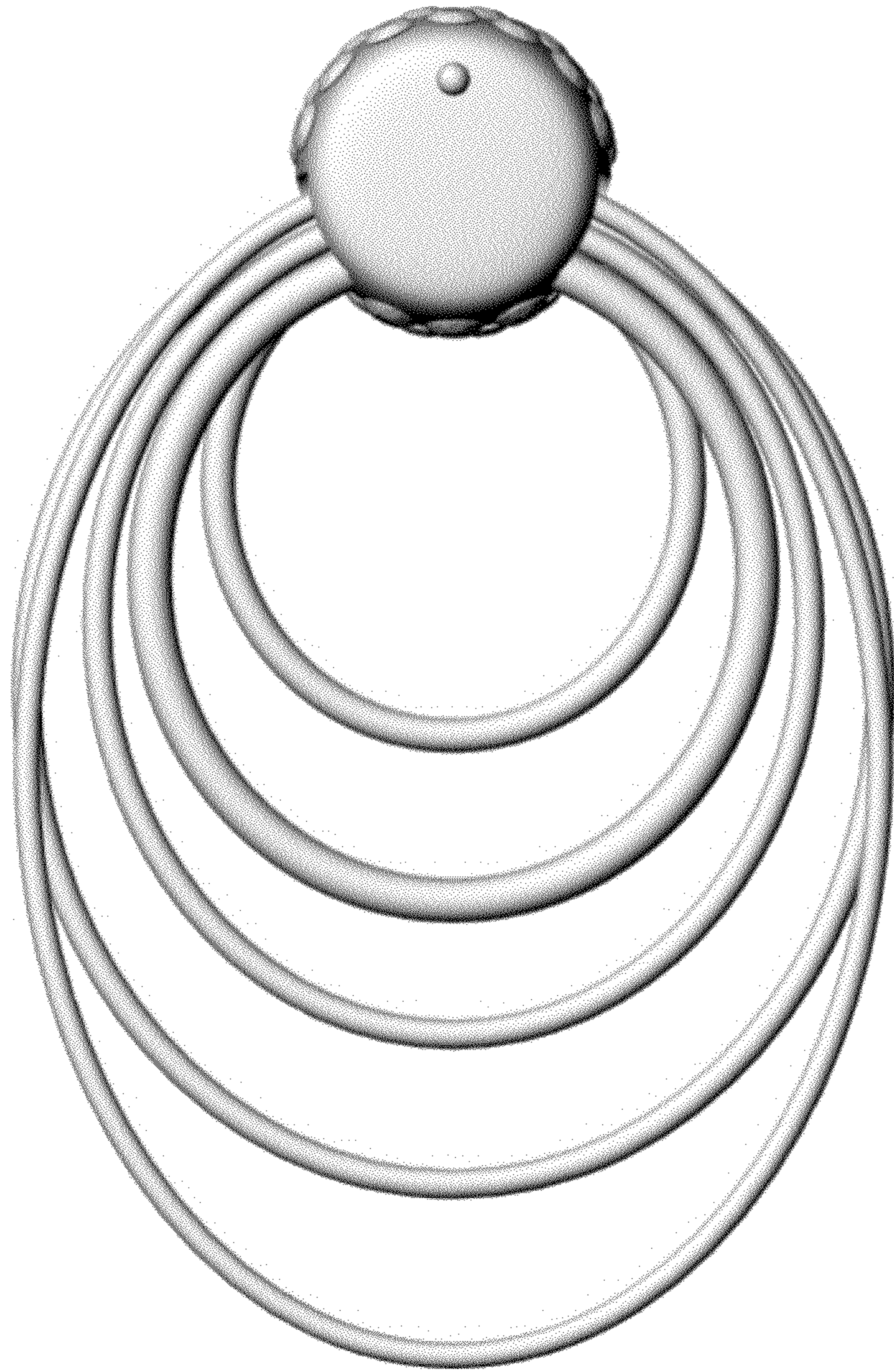

FIG. 14

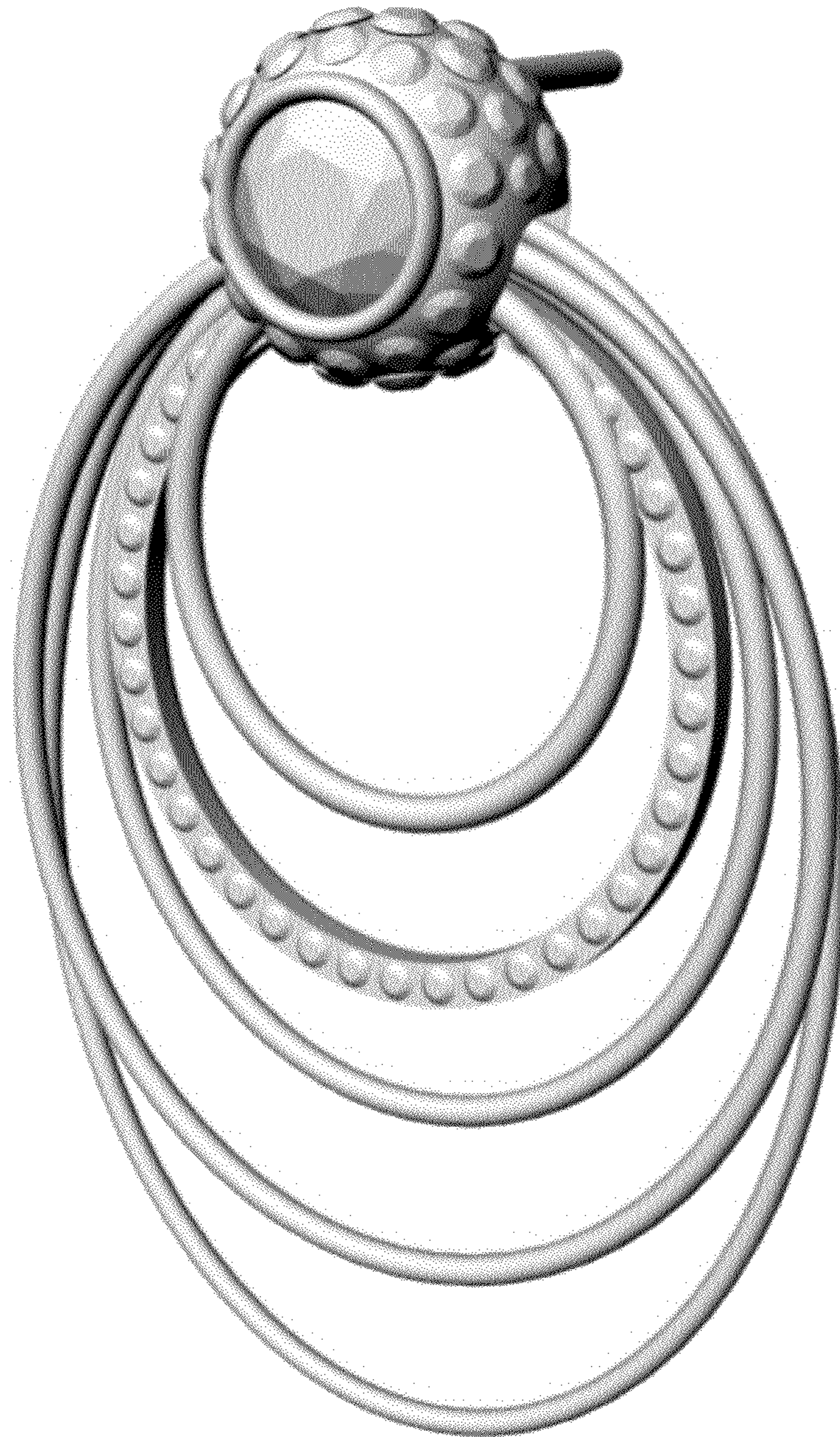

FIG. 15

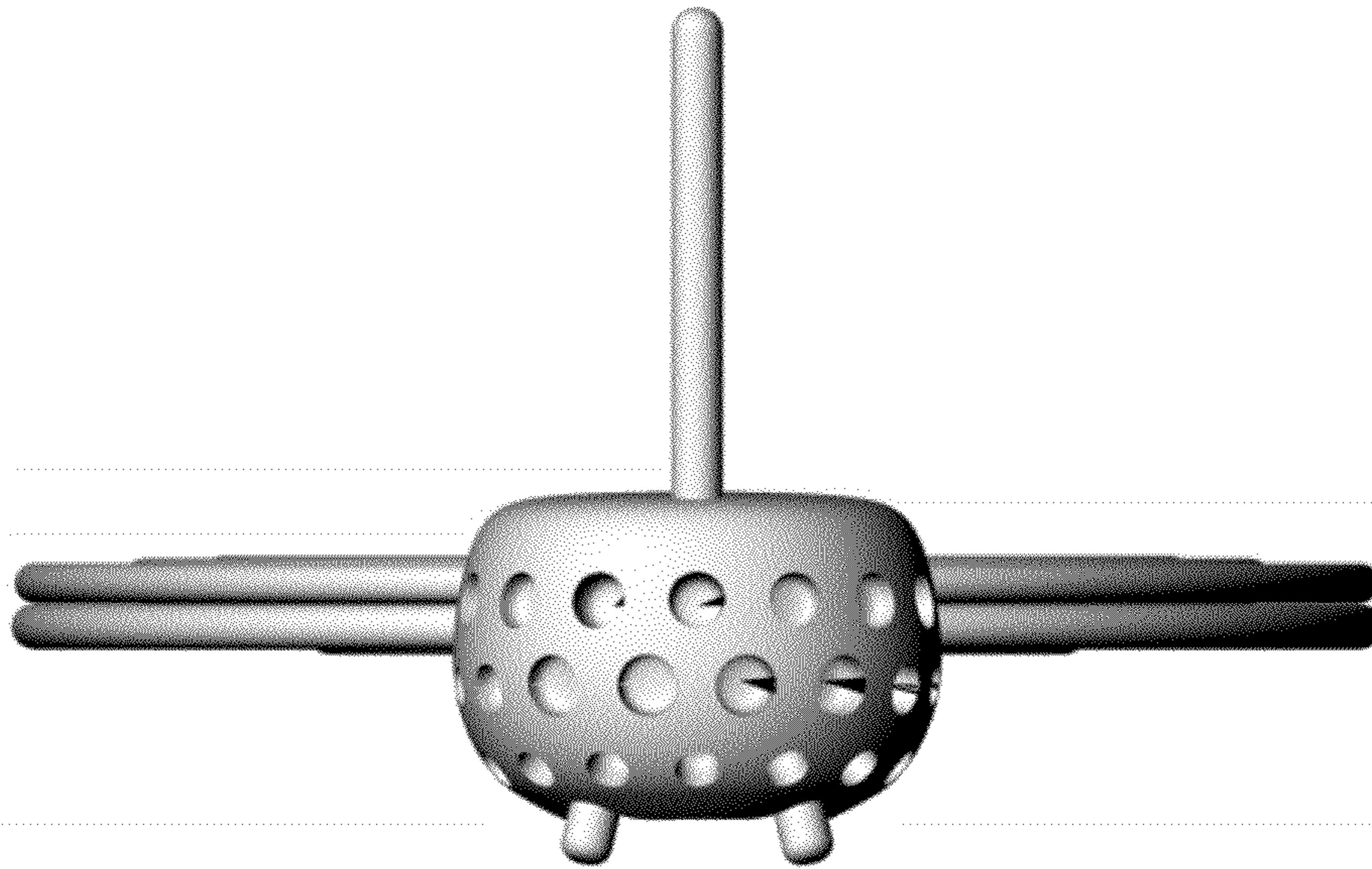

FIG. 16

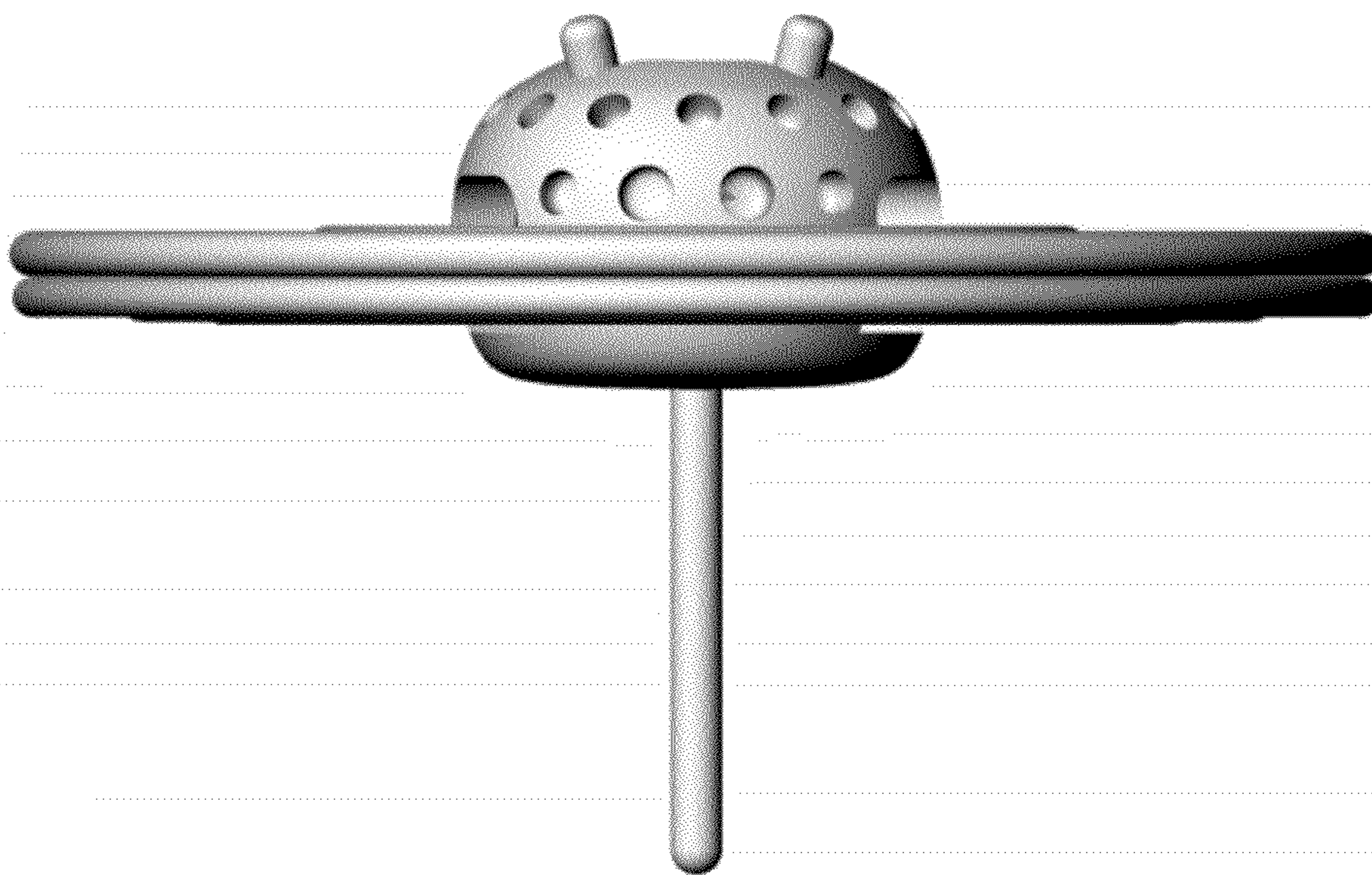

FIG. 17

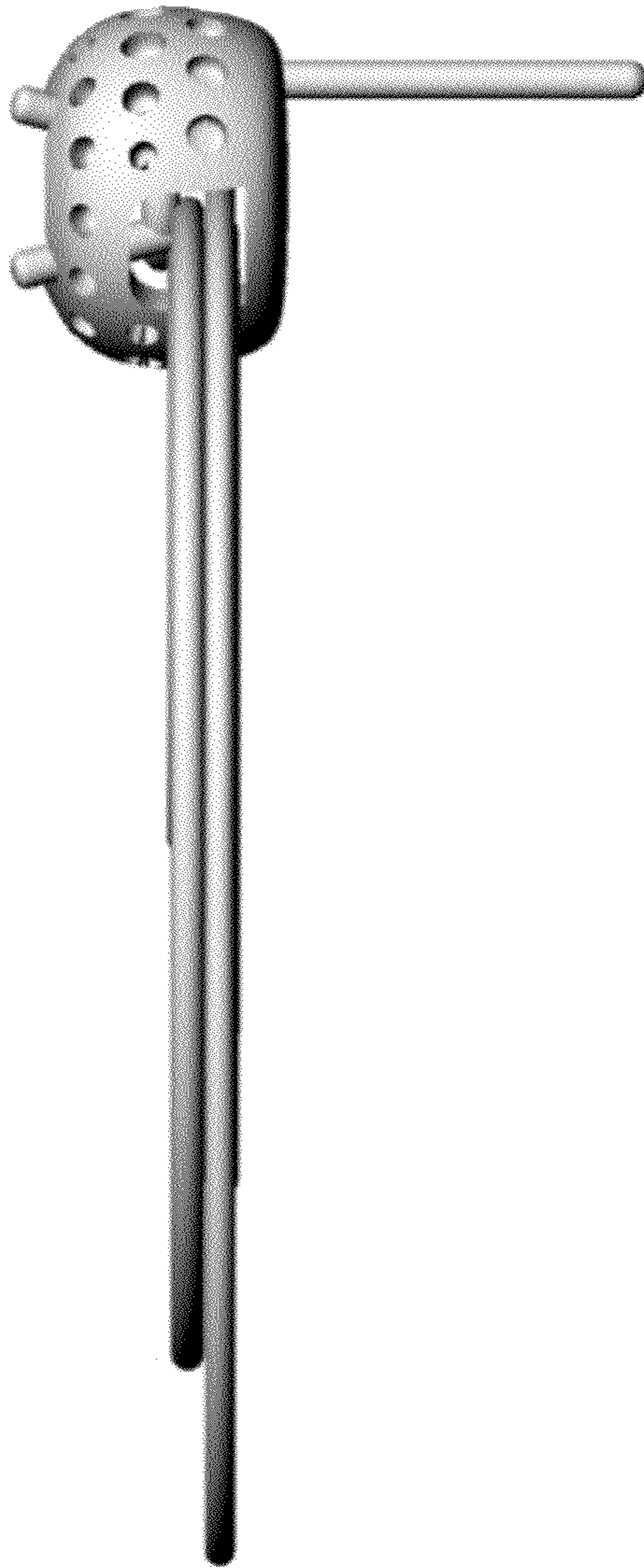

FIG. 18

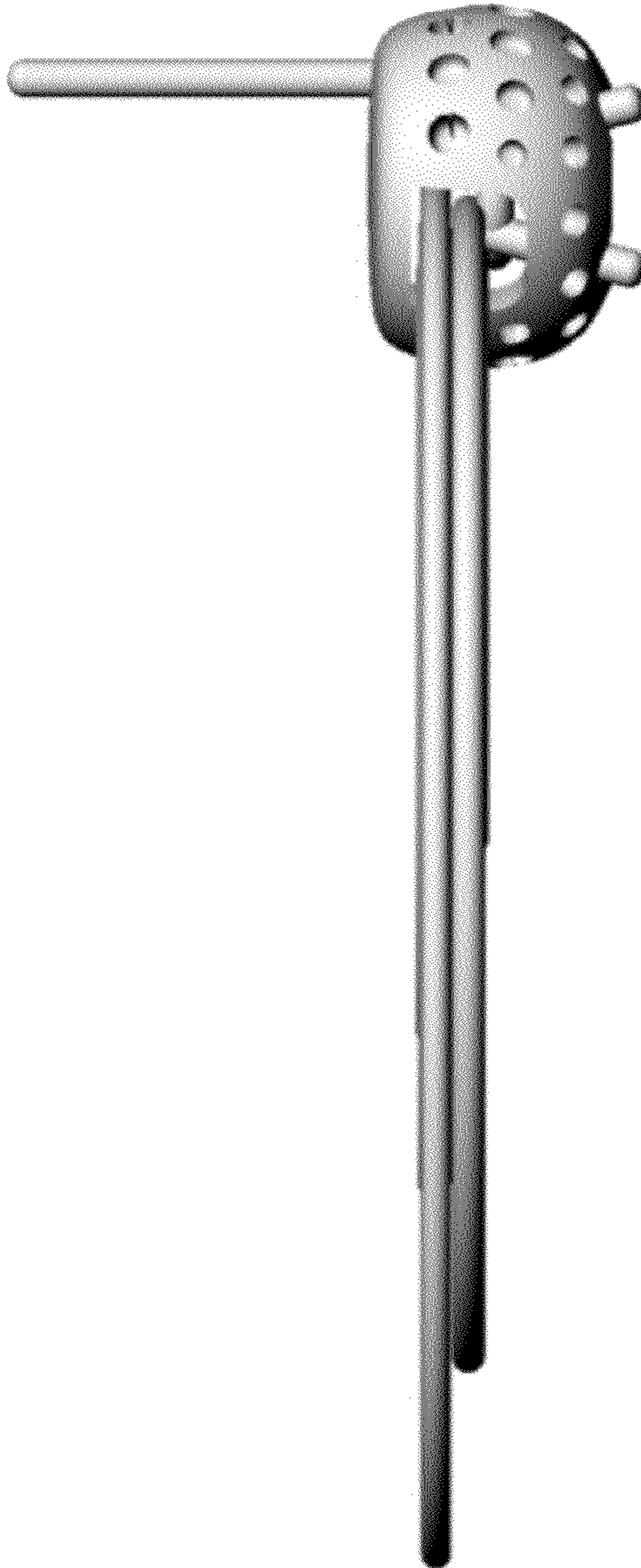

FIG. 19



FIG. 20

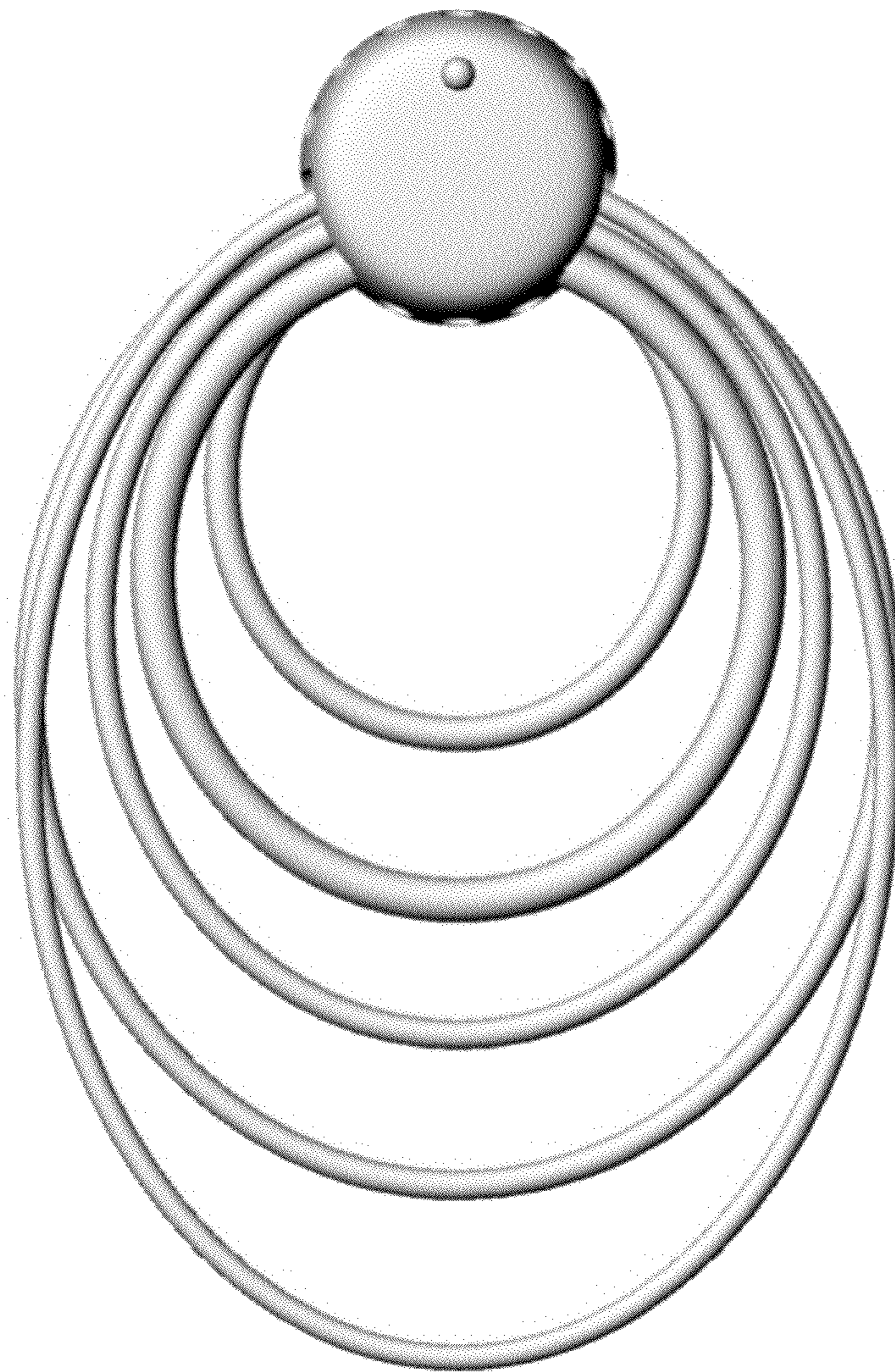

FIG. 21

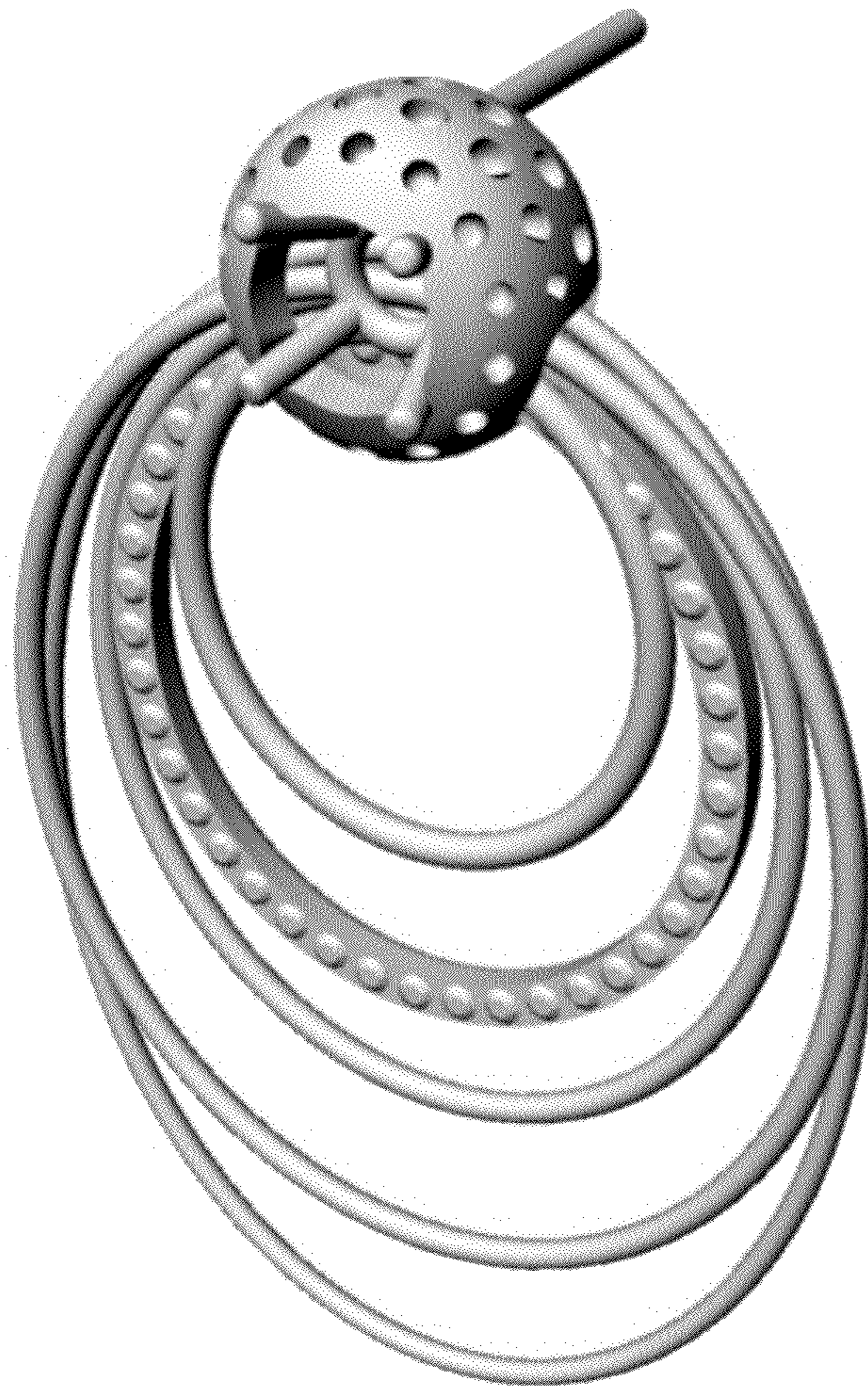

FIG. 22

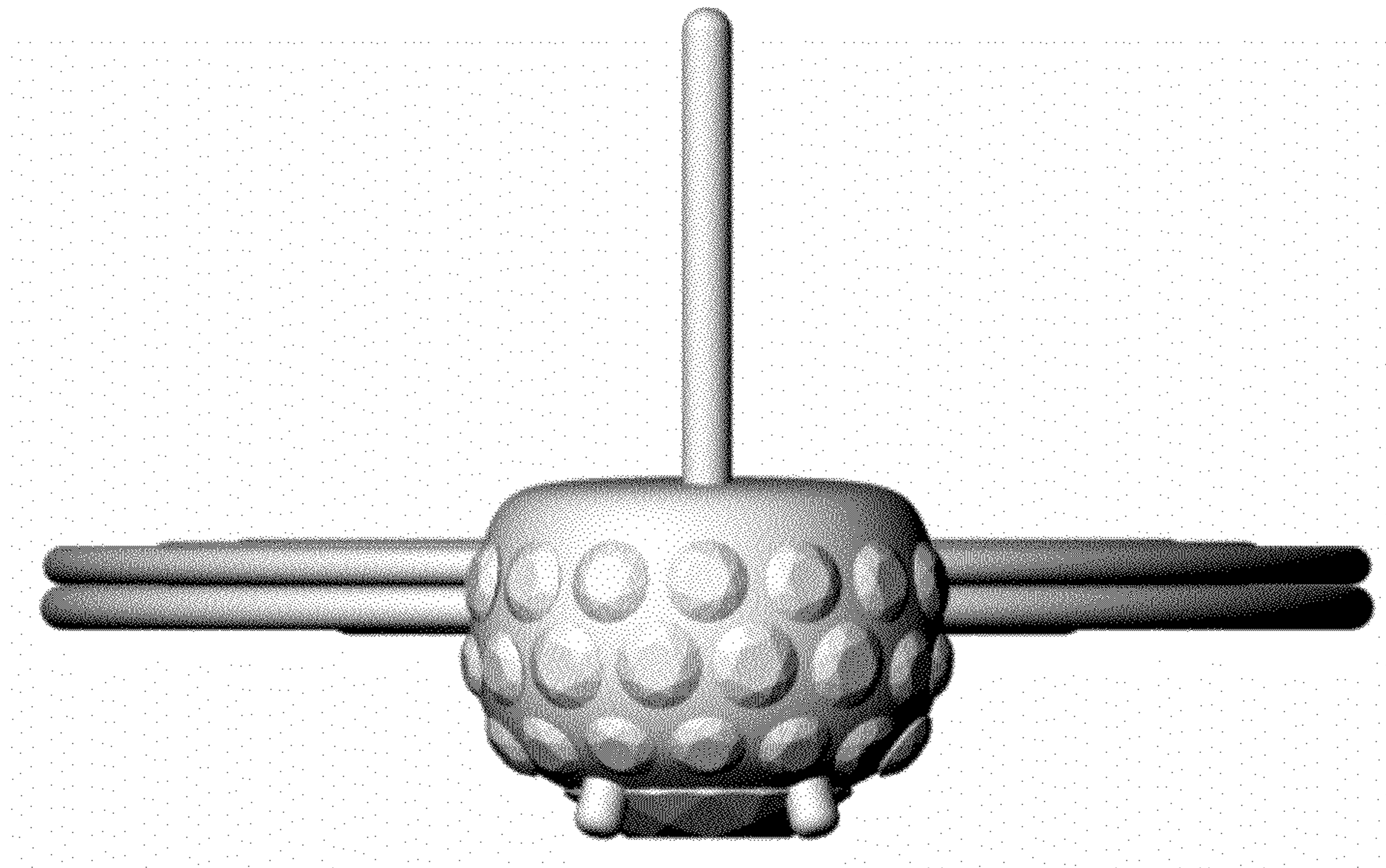

FIG. 23

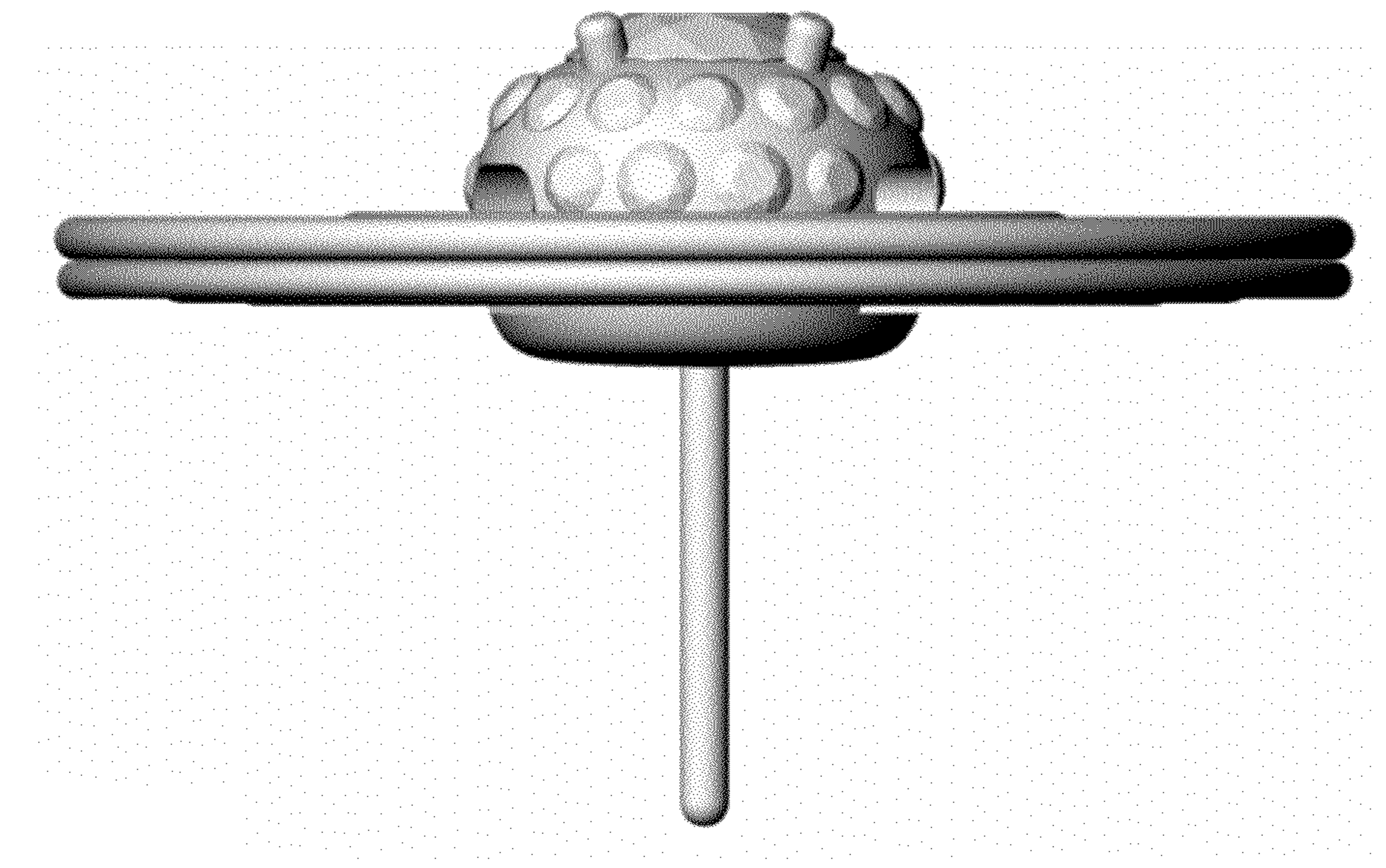

FIG. 24

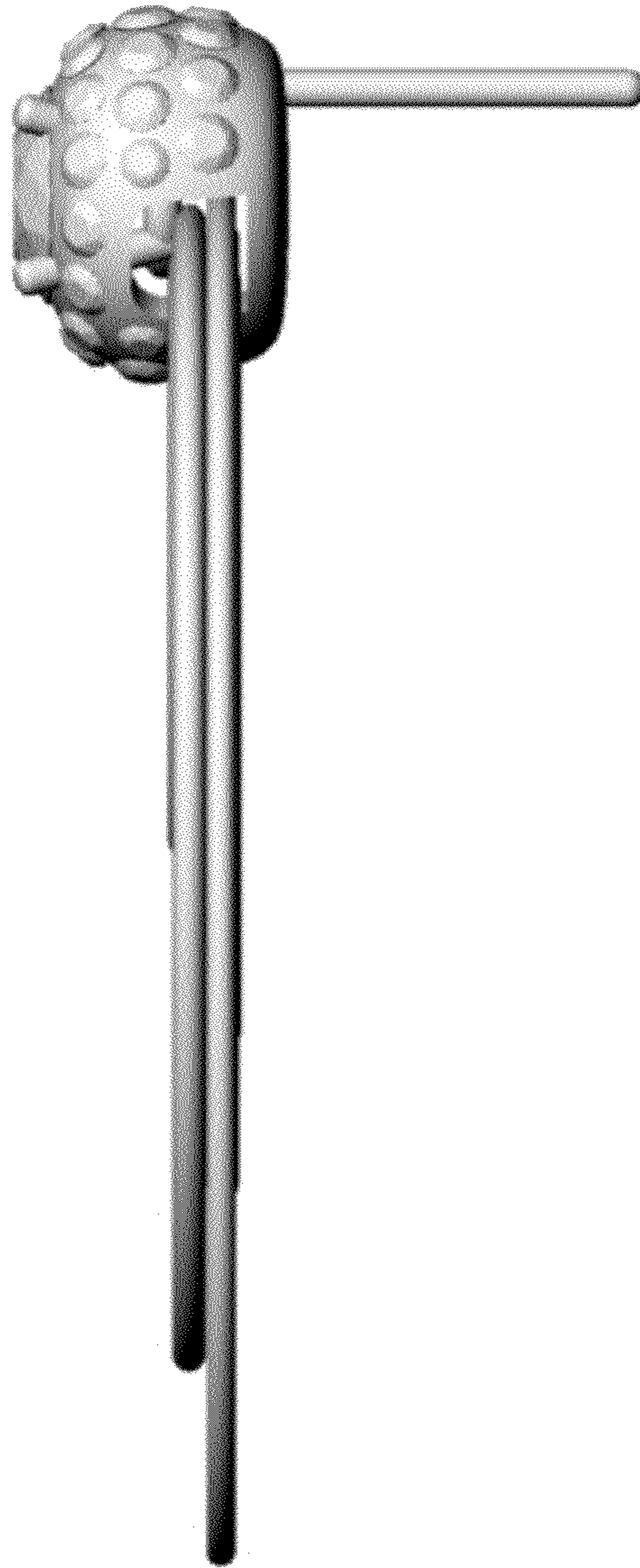

FIG. 25

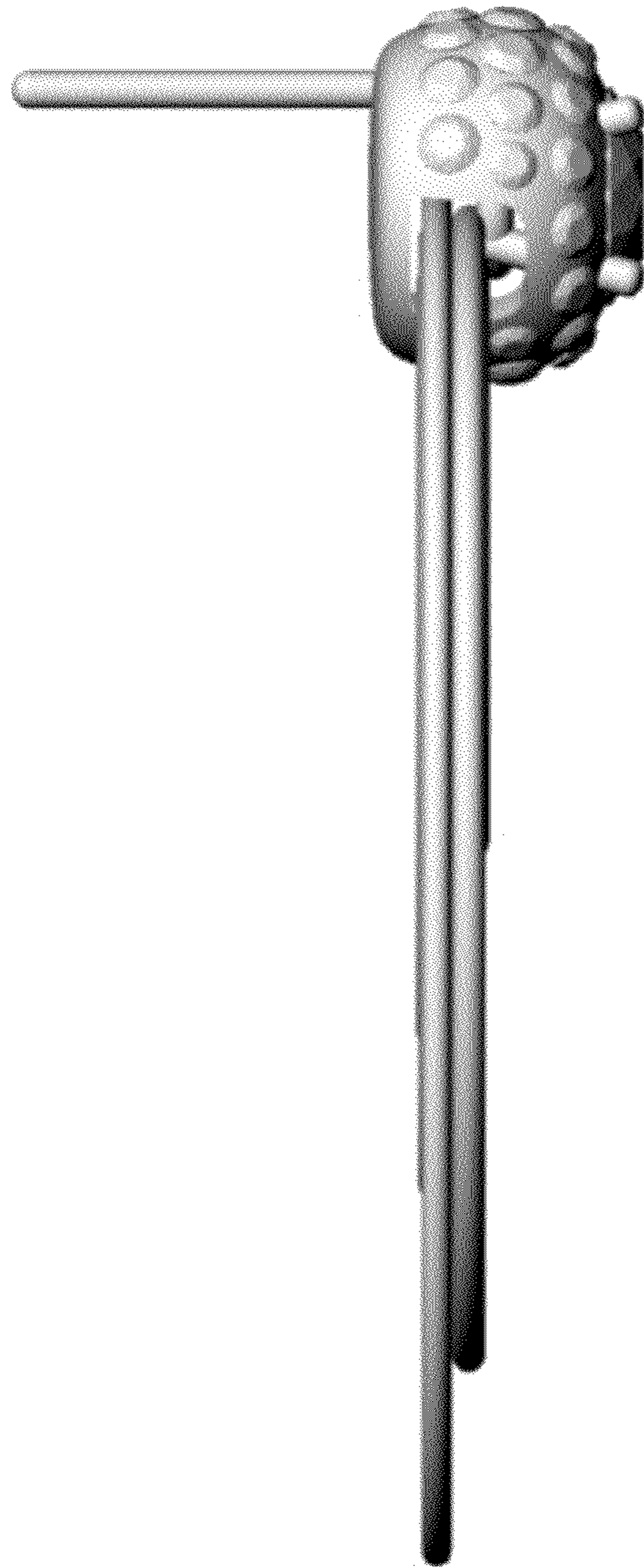

FIG. 26



FIG. 27

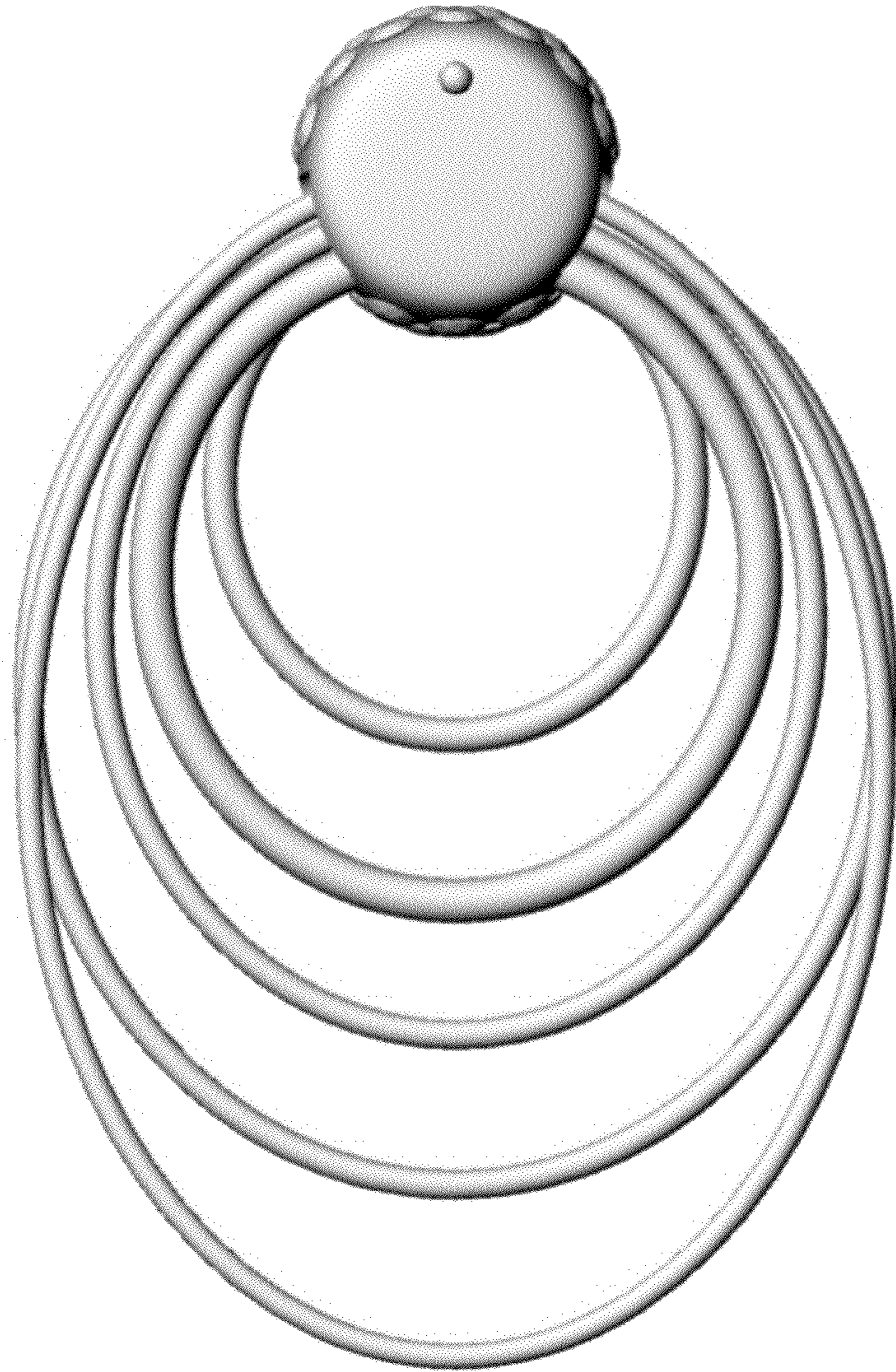

FIG. 28

