



US00D673050S

(12) **United States Design Patent**  
**Pennington, IV et al.**

(10) **Patent No.:** **US D673,050 S**

(45) **Date of Patent:** **\*\* Dec. 25, 2012**

(54) **BOTTLE**

(76) Inventors: **Jefferson Pennington, IV**, Nashville, TN (US); **Jenny Pennington**, Nashville, TN (US)

(\*\*) Term: **14 Years**

(21) Appl. No.: **29/393,265**

(22) Filed: **Jun. 1, 2011**

(51) **LOC (9) Cl.** ..... **09-01**

(52) **U.S. Cl.** ..... **D9/531; D9/540**

(58) **Field of Classification Search** ..... D9/434,  
D9/500, 502-504, 516, 530, 531, 537, 538,  
D9/540, 543, 575; 215/381-385; 220/660,  
220/662, 675

See application file for complete search history.

(56) **References Cited**

**U.S. PATENT DOCUMENTS**

D222,529	S *	11/1971	Terner	.....	D9/500
D273,278	S *	4/1984	Hayes	.....	D9/434
D273,367	S *	4/1984	Hayes	.....	D9/434
D273,368	S *	4/1984	Hayes	.....	D9/434
D412,281	S *	7/1999	Lindsay et al.	.....	D9/500
D430,803	S *	9/2000	Reis et al.	.....	D9/500
7,228,982	B2 *	6/2007	Nielson	.....	215/396

D571,213	S *	6/2008	Le Bras-Brown et al.	.....	D9/516
D572,134	S *	7/2008	Bourne	.....	D9/500
D580,770	S *	11/2008	Matauch	.....	D9/551
D620,362	S *	7/2010	Boukobza	.....	D9/500
D620,799	S *	8/2010	Wingfield et al.	.....	D9/503
D661,586	S *	6/2012	Renieris	.....	D9/500
2006/0124579	A1 *	6/2006	Nielson	.....	215/396

\* cited by examiner

*Primary Examiner* — Keli L Hill

(74) *Attorney, Agent, or Firm* — Pitts & Lake, P.C.

(57) **CLAIM**

The ornamental design for a bottle, as shown and described.

**DESCRIPTION**

FIG. 1 is a perspective view of the design of the present invention for a bottle;

FIG. 2 is a front elevation view of the invention of FIG. 1;

FIG. 3 is a rear elevation view of the invention of FIG. 1;

FIG. 4 is a left side elevation view of the invention of FIG. 1;

FIG. 5 is a right side elevation view of the invention of FIG. 1;

FIG. 6 is a top end view of the invention of FIG. 1; and,

FIG. 7 is a bottom end view of the invention of FIG. 1.

**1 Claim, 6 Drawing Sheets**

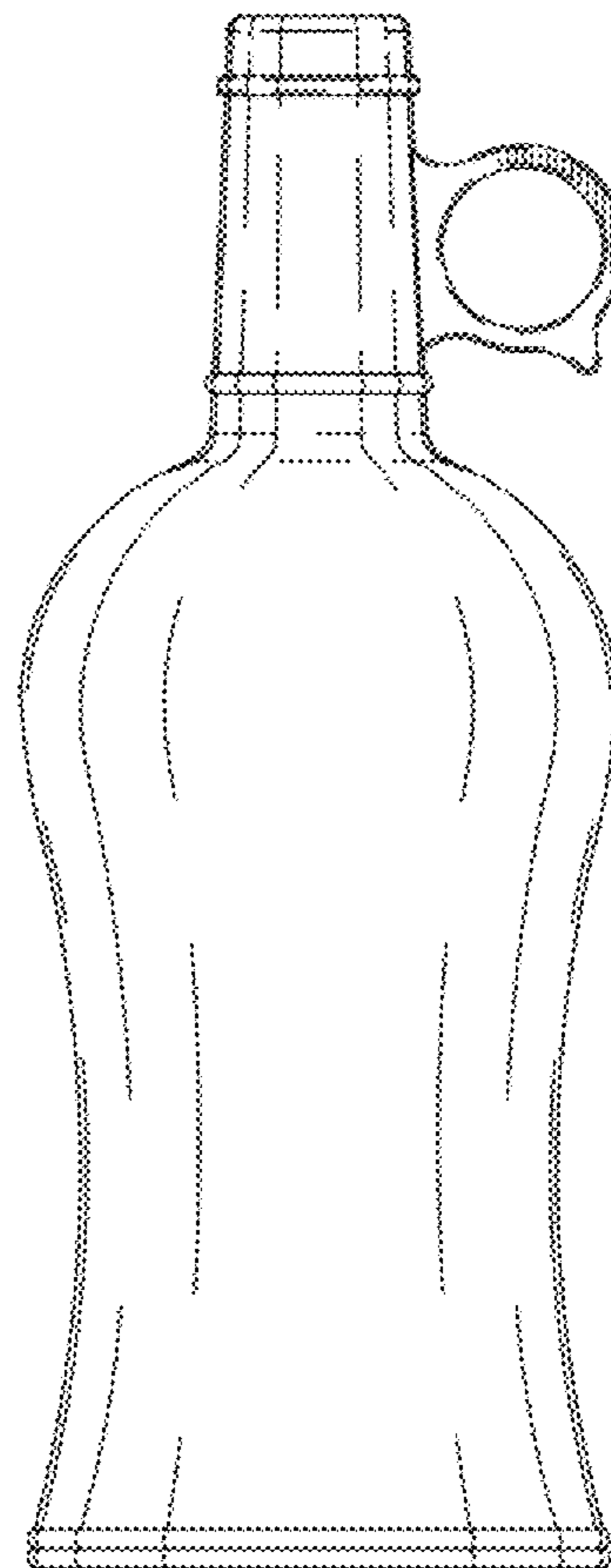
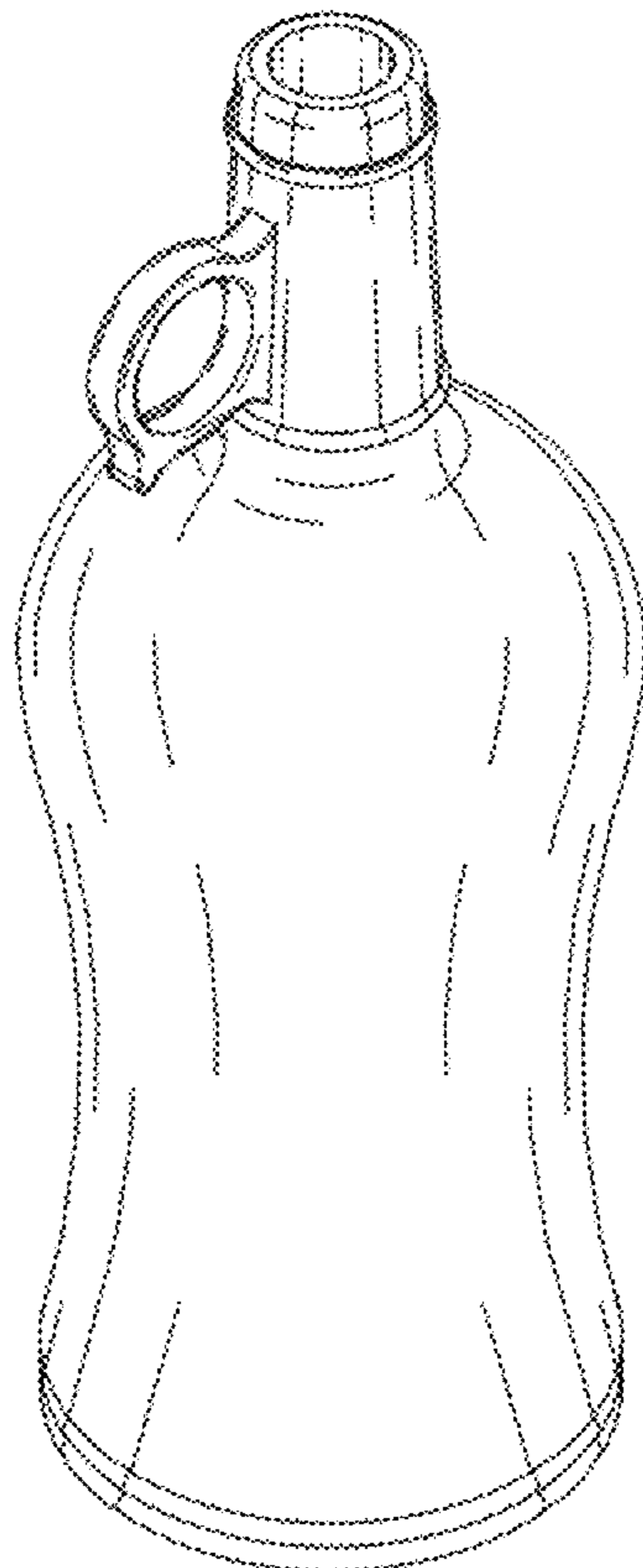

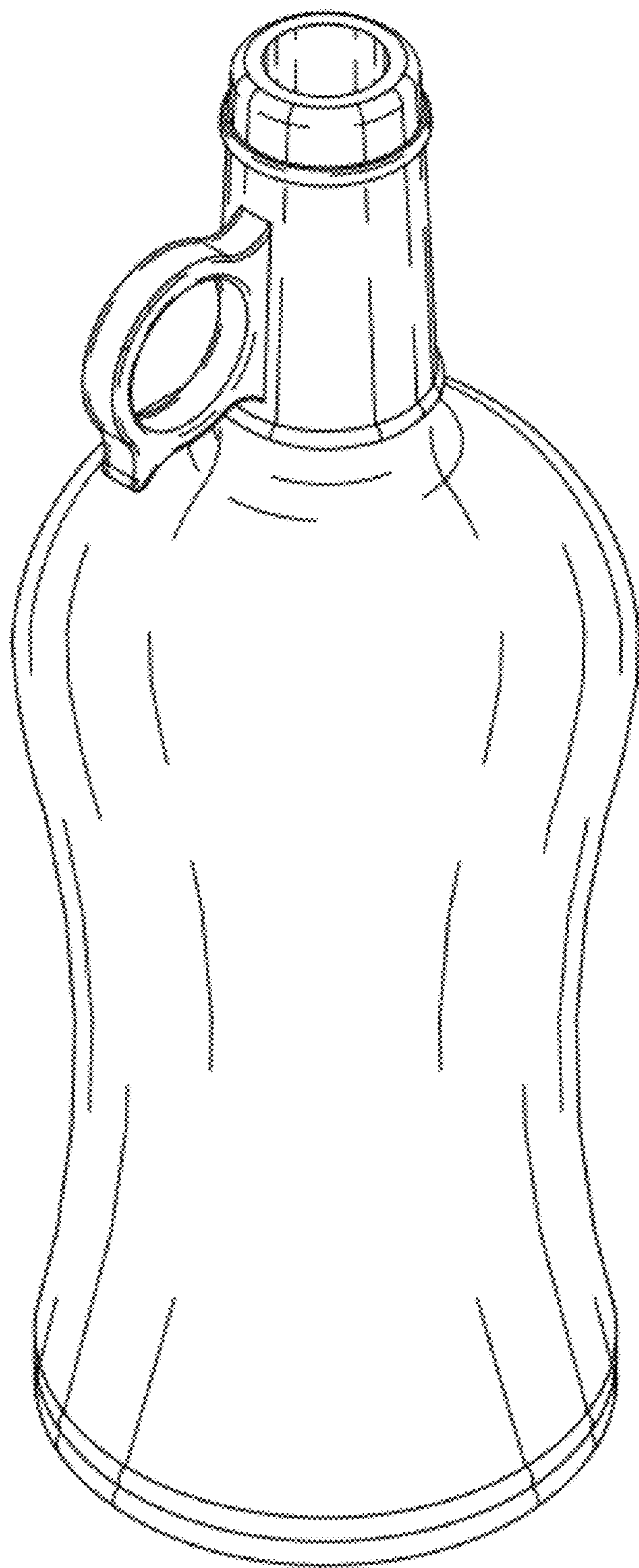

Fig. 1

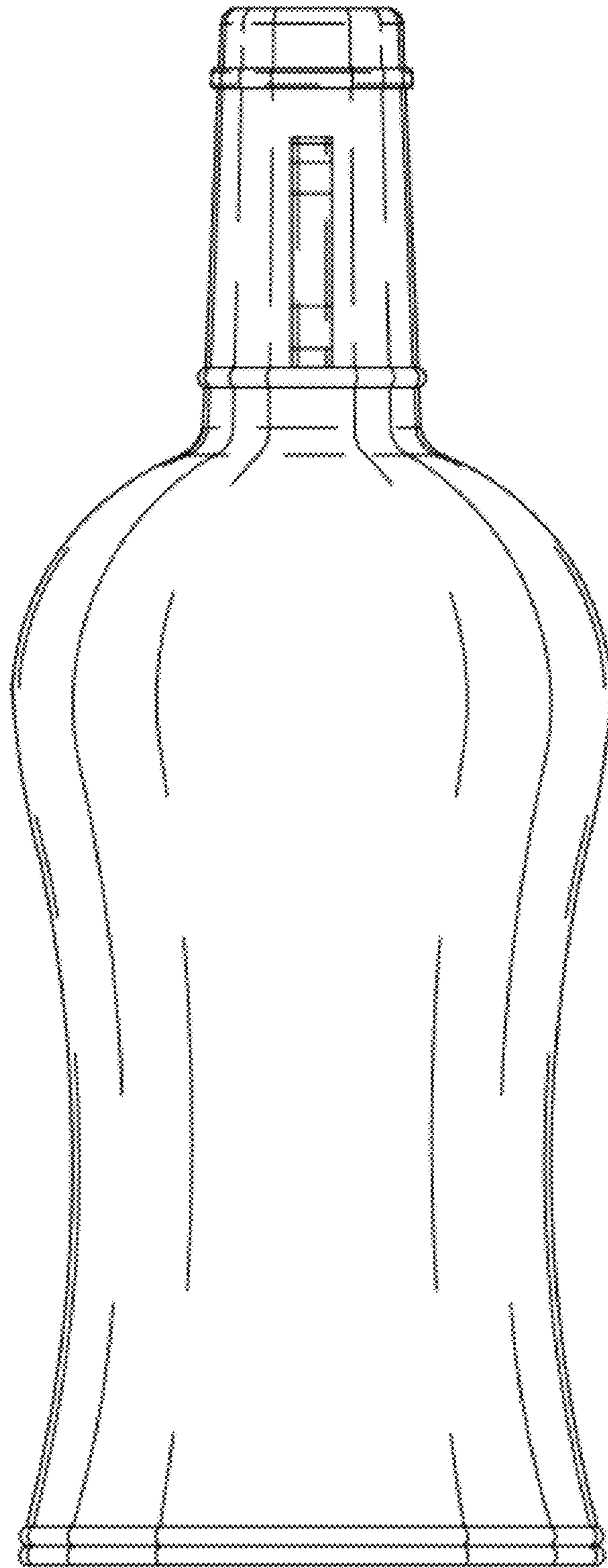

Fig. 2

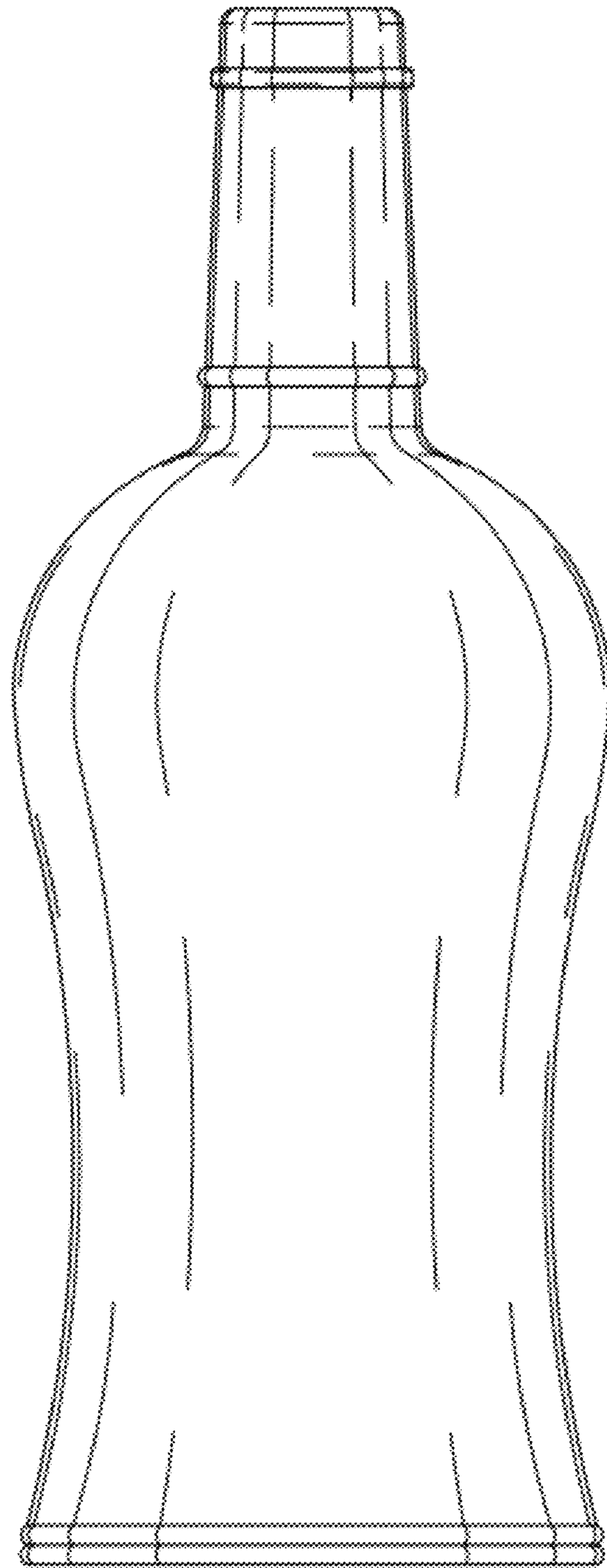

Fig. 3



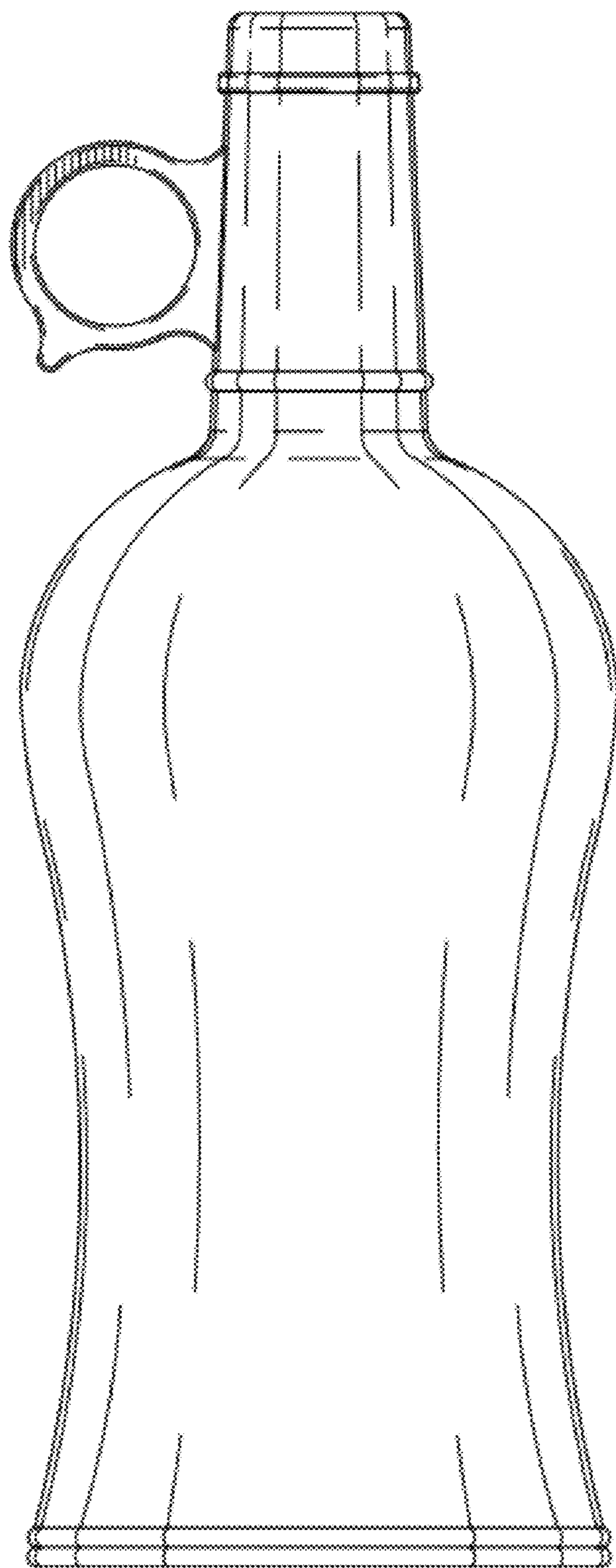

Fig. 4

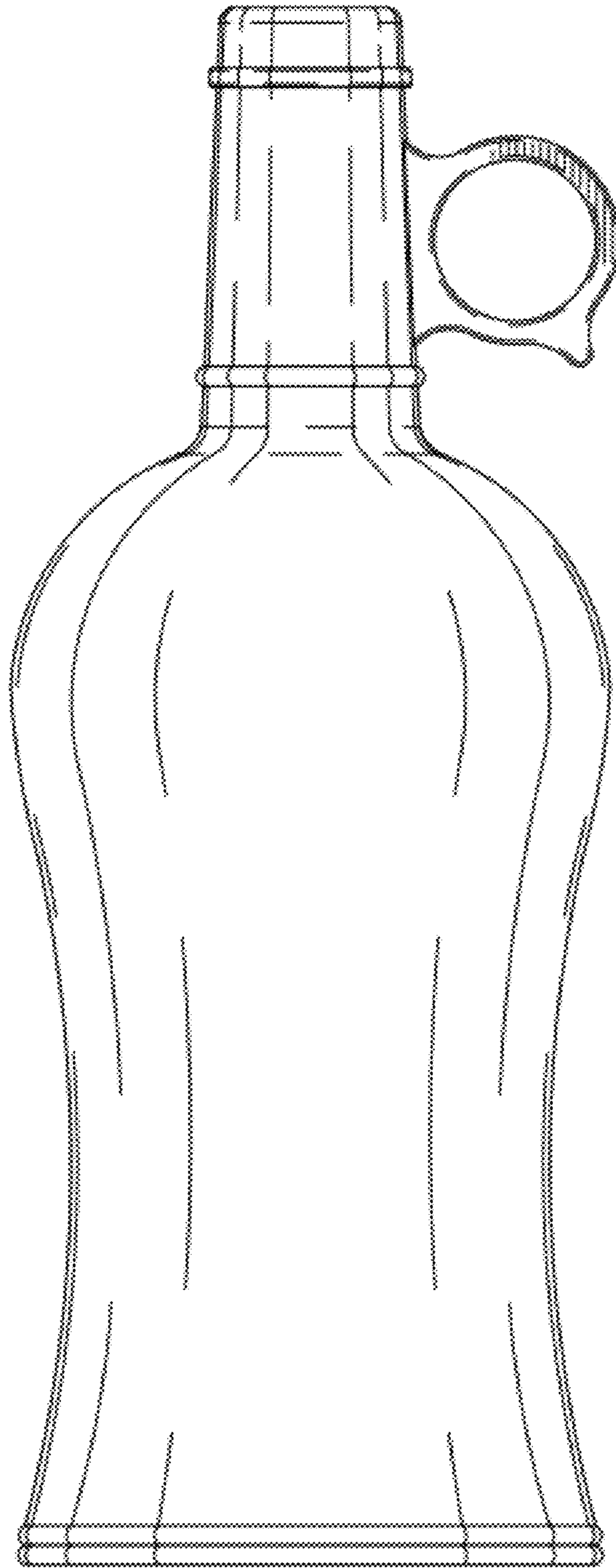

Fig. 5

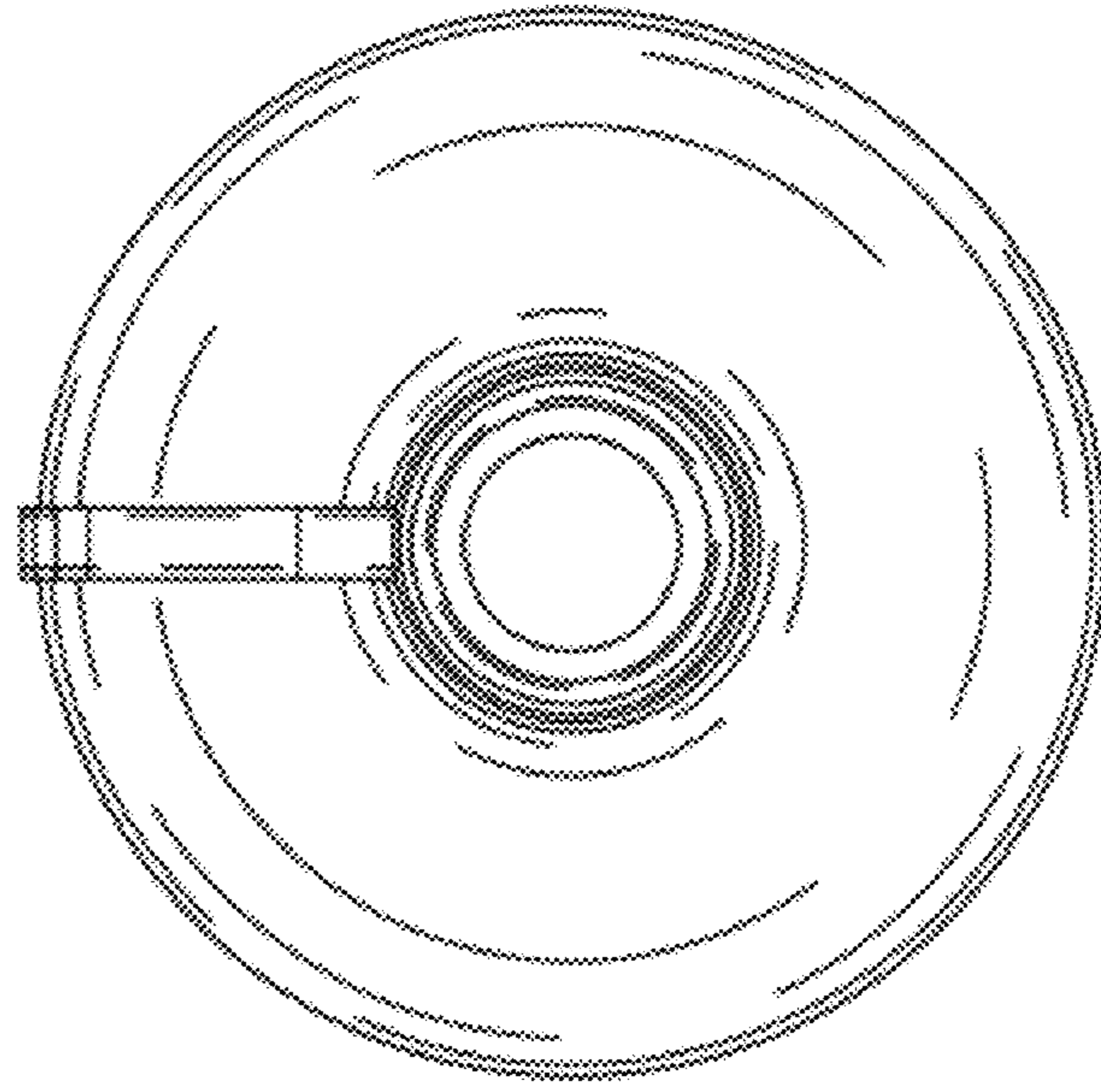

Fig. 6

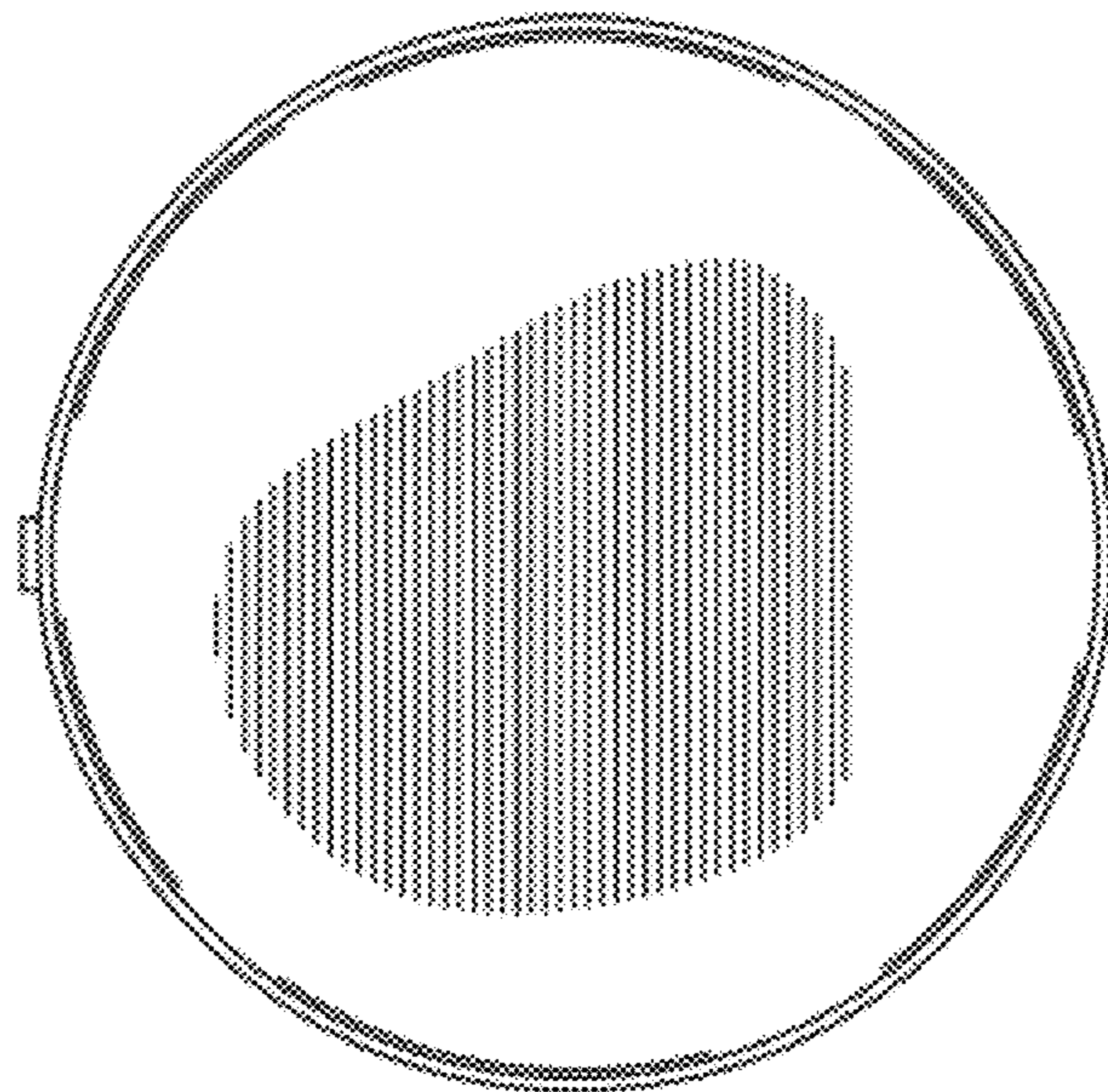

Fig. 7