



US00D673033S

(12) **United States Design Patent**
Houry

(10) **Patent No.:** **US D673,033 S**
(45) **Date of Patent:** **** Dec. 25, 2012**

(54) **CRIB**

(75) Inventor: **Robert L. Houry**, Willowick, OH (US)

(73) Assignee: **Foundations Worldwide, Inc.**, Medina, OH (US)

(**) Term: **14 Years**

(21) Appl. No.: **29/391,507**

(22) Filed: **May 10, 2011**

(51) **LOC (9) Cl.** **08-09**

(52) **U.S. Cl.** **D8/403; D6/390**

(58) **Field of Classification Search** **D8/403;**
D6/390, 391; 5/93.1, 100

See application file for complete search history.

(56) **References Cited**

U.S. PATENT DOCUMENTS

D410,381	S	*	6/1999	Johnson, III	D8/403
D579,696	S	*	11/2008	Houry	D6/503
D590,194	S	*	4/2009	Houry et al.	D6/503
D595,073	S	*	6/2009	Houry et al.	D6/503
7,568,244	B1	*	8/2009	Shamie et al.	5/100
D628,879	S	*	12/2010	Kindig	D8/403
7,917,976	B1	*	4/2011	Shamie et al.	5/93.1
D661,121	S	*	6/2012	Houry et al.	D6/390
D661,138	S	*	6/2012	Lytle	D6/503
D666,470	S	*	9/2012	Biter et al.	D8/331

OTHER PUBLICATIONS

First Responder Evacuation Crib, [online], [site visited Sep. 10, 2012]. Available from Internet, <URL:http://www.foundations.com/first-responder.html>.*

* cited by examiner

Primary Examiner — Robert M Spear

Assistant Examiner — Janice Hallmark

(74) *Attorney, Agent, or Firm* — Christopher L. Parmelee; Walker & Jocke

(57) **CLAIM**

The ornamental design for a crib, as shown and described.

DESCRIPTION

FIG. 1 is an upper perspective view showing my new design for a crib.

FIG. 2 is a lower perspective view thereof.

FIG. 3 is front side plan view thereof, the back side being a minor image.

FIG. 4 is a right side plan view thereof, the left side being a mirror image.

FIG. 5 is a top side plan view thereof; and,

FIG. 6 is a bottom side plan view thereof.

The broken lines representing the outline of portions of the crib depict environmental subject matter only, and form no part of the claimed design.

1 Claim, 6 Drawing Sheets

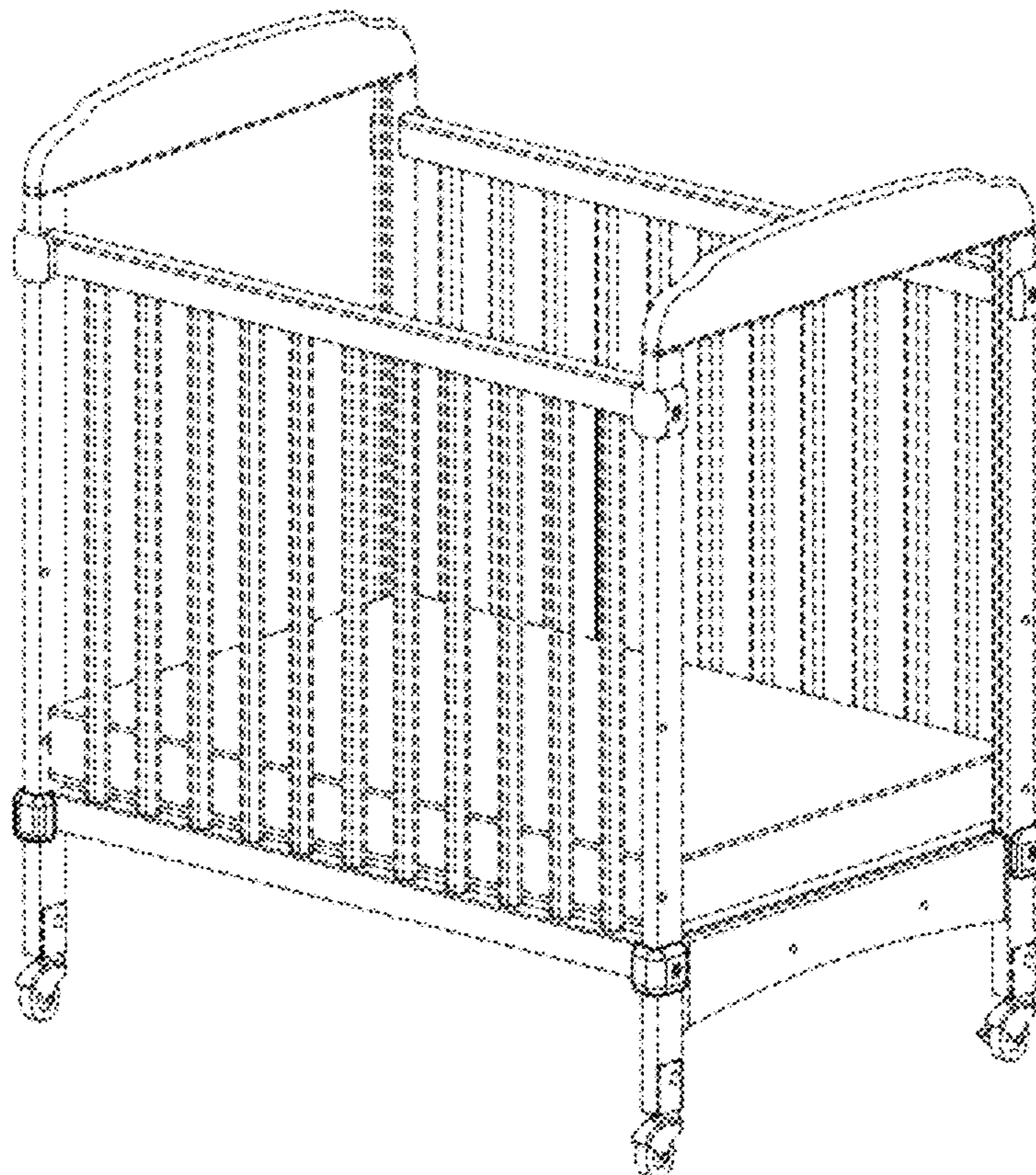

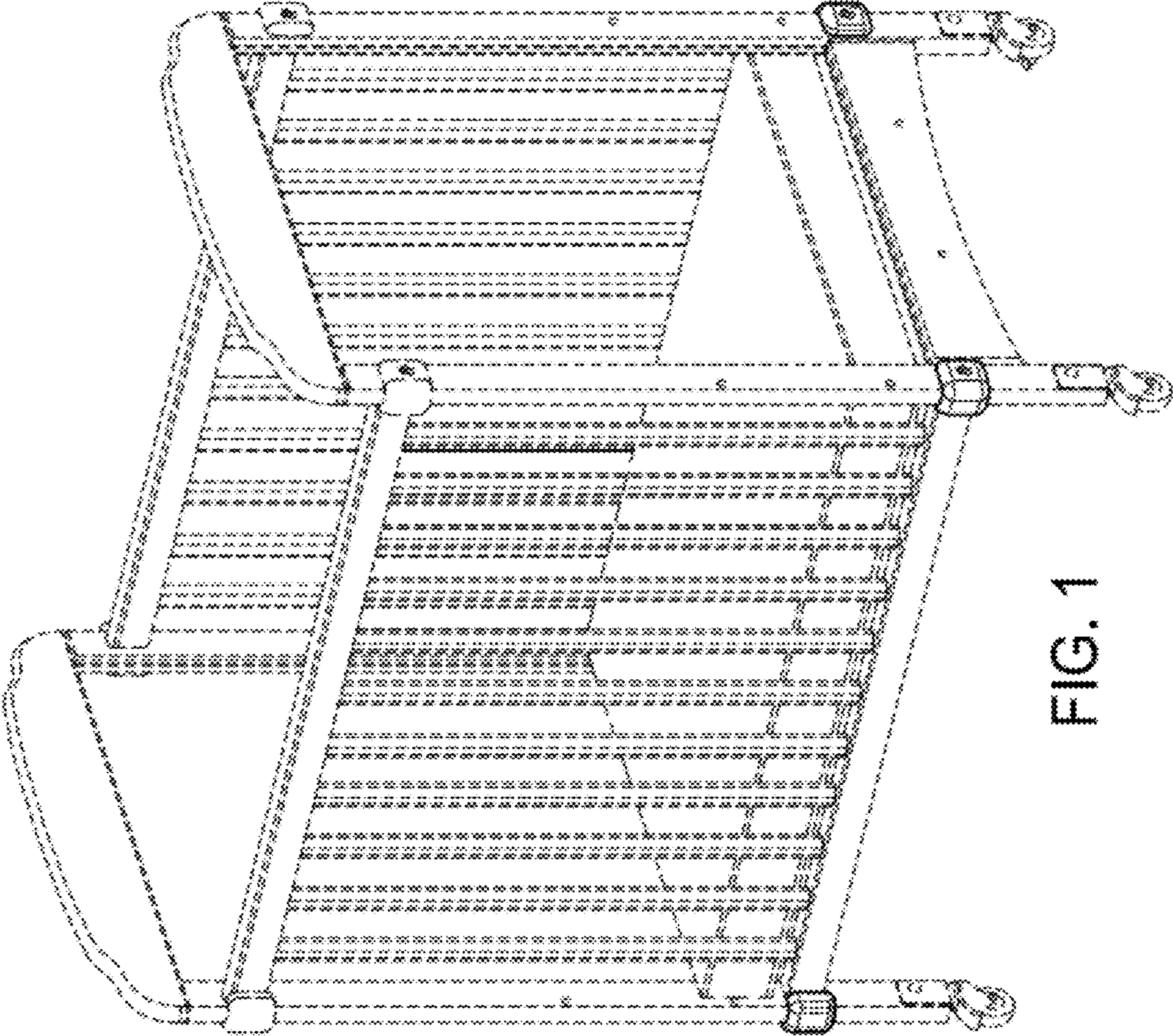

FIG. 1

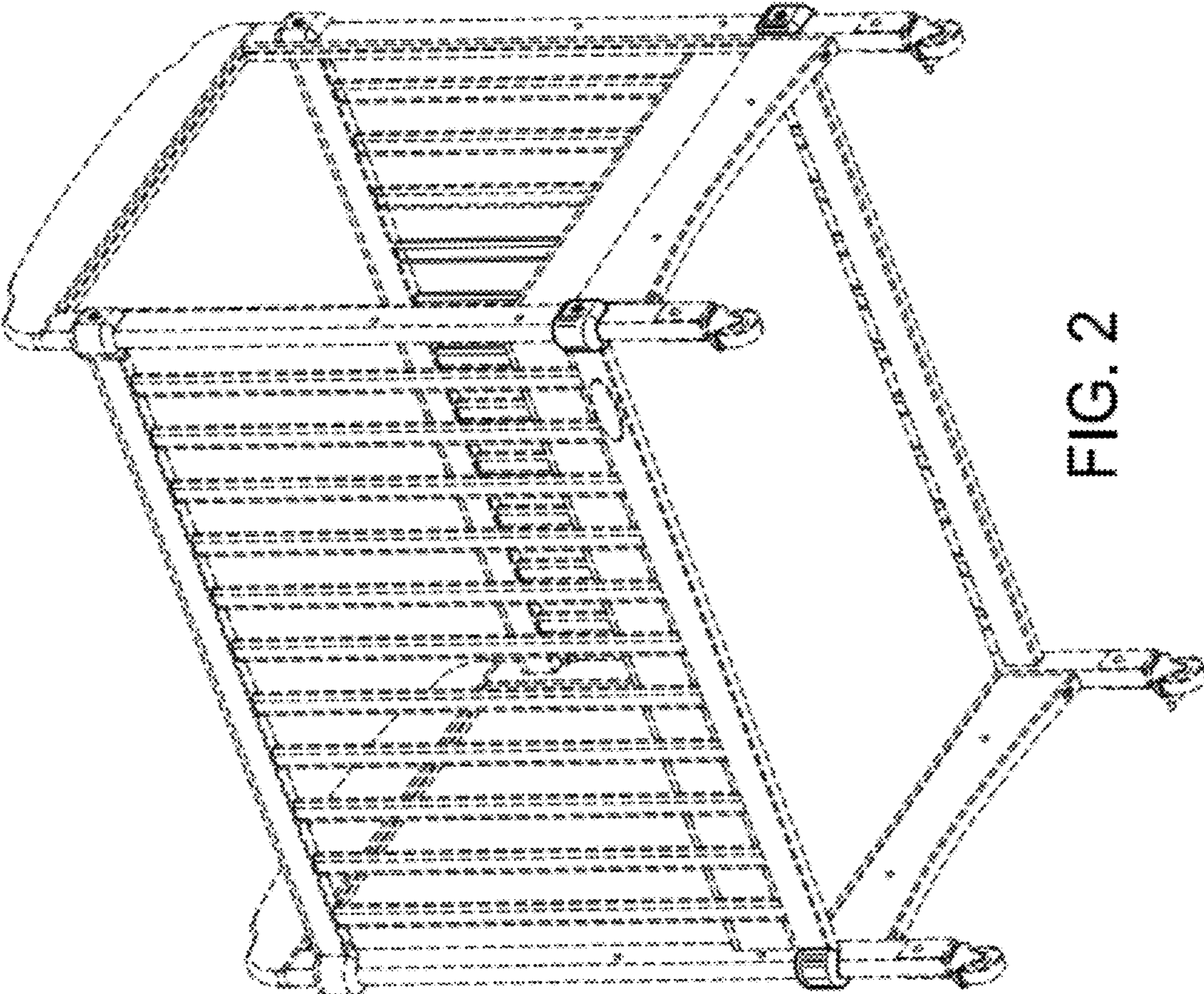

FIG. 2

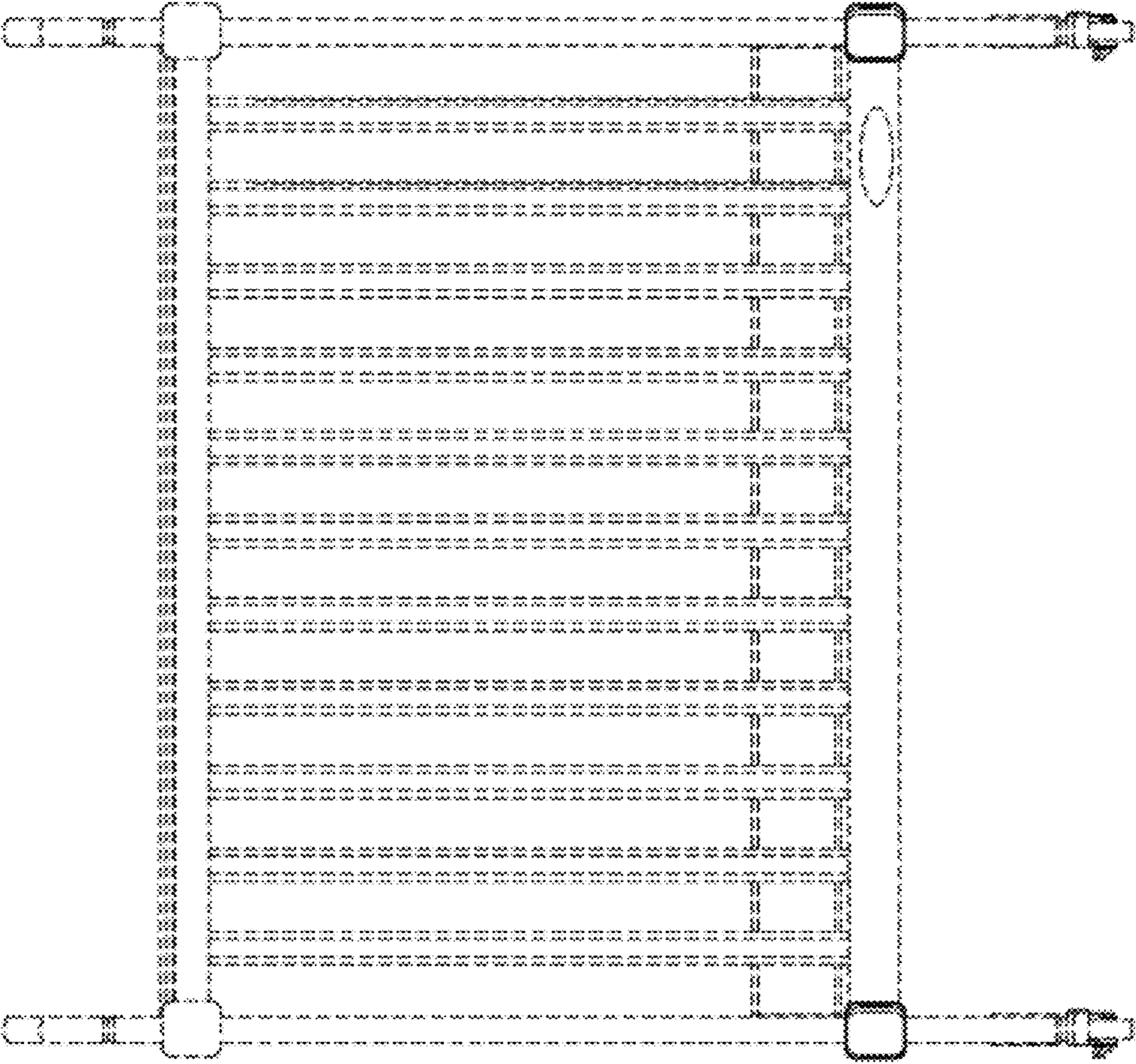

FIG. 3

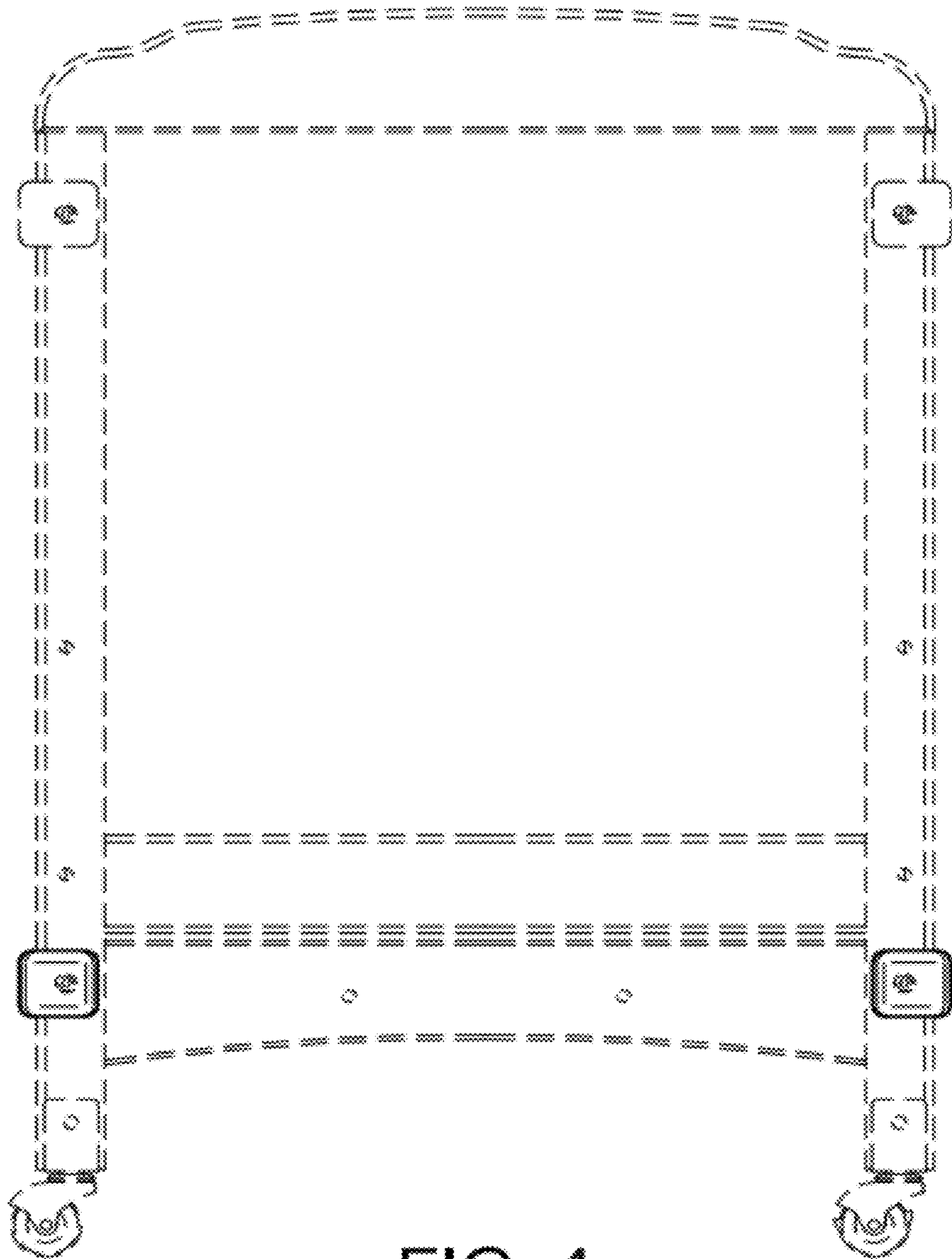

FIG. 4

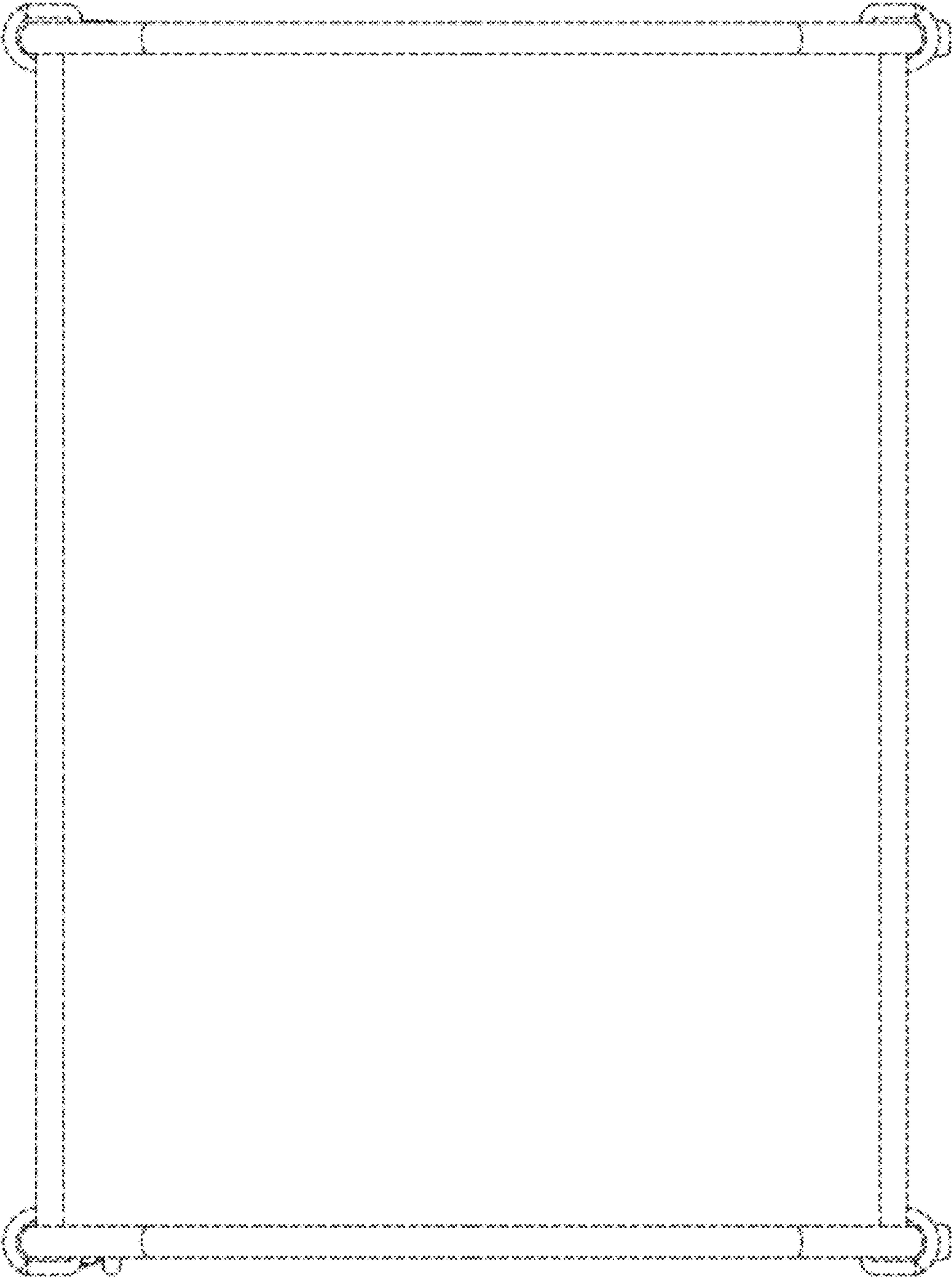

FIG. 5

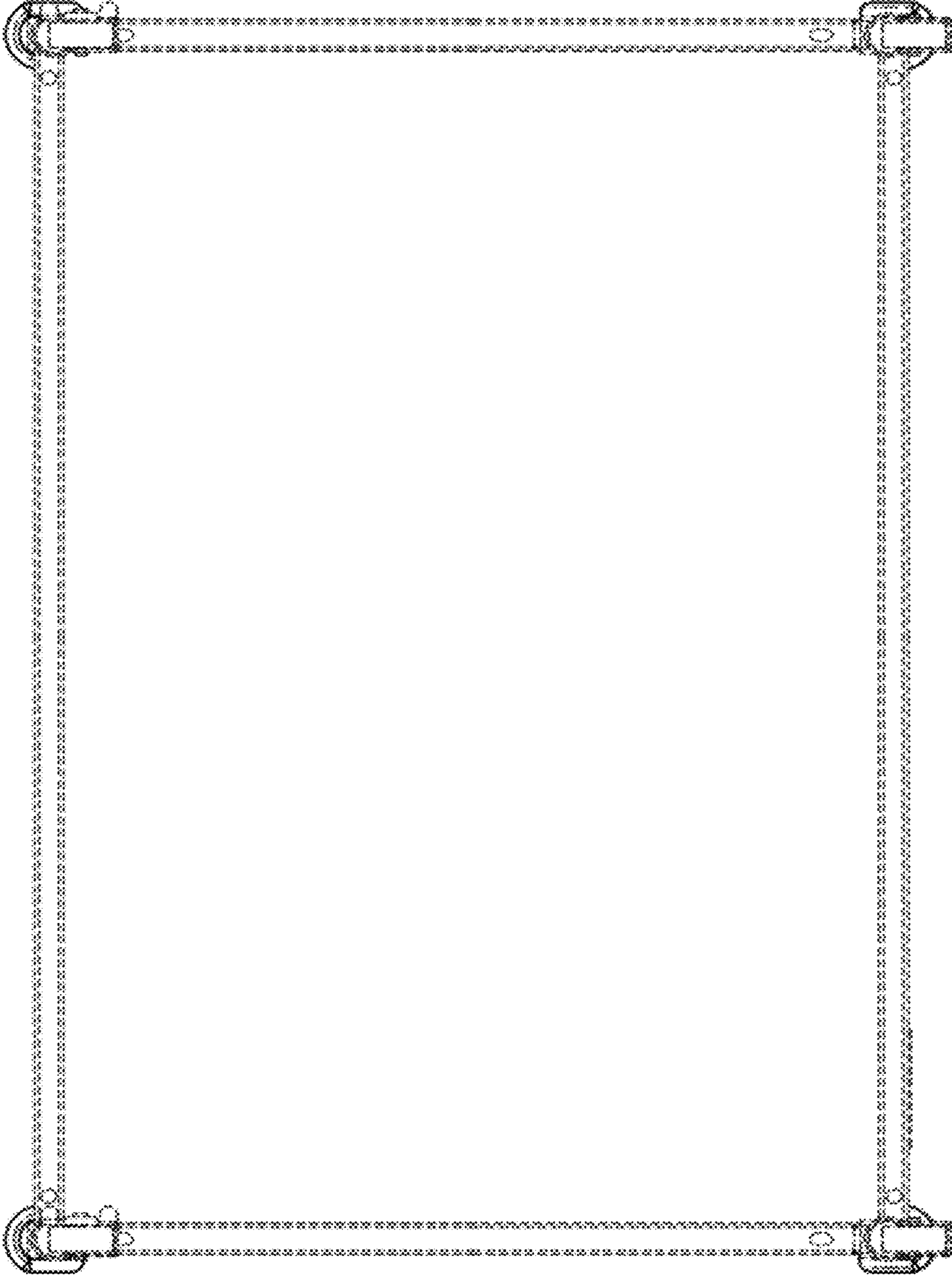

FIG. 6