



US00D672934S

(12) **United States Design Patent**
Salomon et al.

(10) **Patent No.:** **US D672,934 S**

(45) **Date of Patent:** **** Dec. 18, 2012**

(54) **INFANT CASKET**

(75) Inventors: **Mindy K. Salomon**, Moscow, ID (US);
Sharilyn Howard, Moscow, ID (US)

(73) Assignee: **ECH Foundation, Inc.**, Moscow, ID
(US)

(**) Term: **14 Years**

(21) Appl. No.: **29/354,098**

(22) Filed: **Jan. 19, 2010**

(51) **LOC (9) Cl.** **06-04**

(52) **U.S. Cl.** **D99/1**

(58) **Field of Classification Search** D99/1-11;
27/1-9, 17, 35; D3/302, 276, 797; D9/414,
D9/424, 425, 432; D34/1, 7; 220/557, 801,
220/797

See application file for complete search history.

(56) **References Cited**

U.S. PATENT DOCUMENTS

D189,136 S *	11/1960	Wohl	D99/3
3,348,280 A *	10/1967	Myers	27/2
D253,975 S *	1/1980	Brunson	D99/6
D328,176 S *	7/1992	Ruble	D99/3
D368,626 S *	4/1996	Hentz	D7/538
D508,599 S *	8/2005	Lefever	D99/1
D539,505 S *	3/2007	White	D99/7

* cited by examiner

Primary Examiner — T. Chase Nelson

Assistant Examiner — Michelle E Wilson

(74) *Attorney, Agent, or Firm* — Kolisch Hartwell, P.C.

(57) **CLAIM**

We claim the ornamental design for an infant casket, as shown and described.

DESCRIPTION

FIG. 1 is an isometric view of an infant casket showing the new design.

FIG. 2 is a side view thereof.

FIG. 3 is a bottom view thereof.

FIG. 4 is a top view thereof.

FIG. 5 is a front view thereof.

FIG. 6 is a top view thereof, wherein a first cover is positioned to expose an inside portion of the infant casket; and,

FIG. 7 is a top view thereof, wherein the first cover and a second cover is positioned to expose the inside of the infant casket.

The broken line(s) shown in the drawings are for illustrative purposes only and form no part of the claimed design.

The stippling and shading lines shown in the drawings represent the approximate three-dimensional contour of the design, and are not intended to indicate surface decoration.

Environment is shown by evenly spaced dash-double-dot-broken lines.

Portions of the infant casket that are not shown in the drawing (s) form no part of the claimed design.

The broken line showing in FIGS. 6 and 7 illustrate portions of the article that form no part of the claimed design.

1 Claim, 4 Drawing Sheets

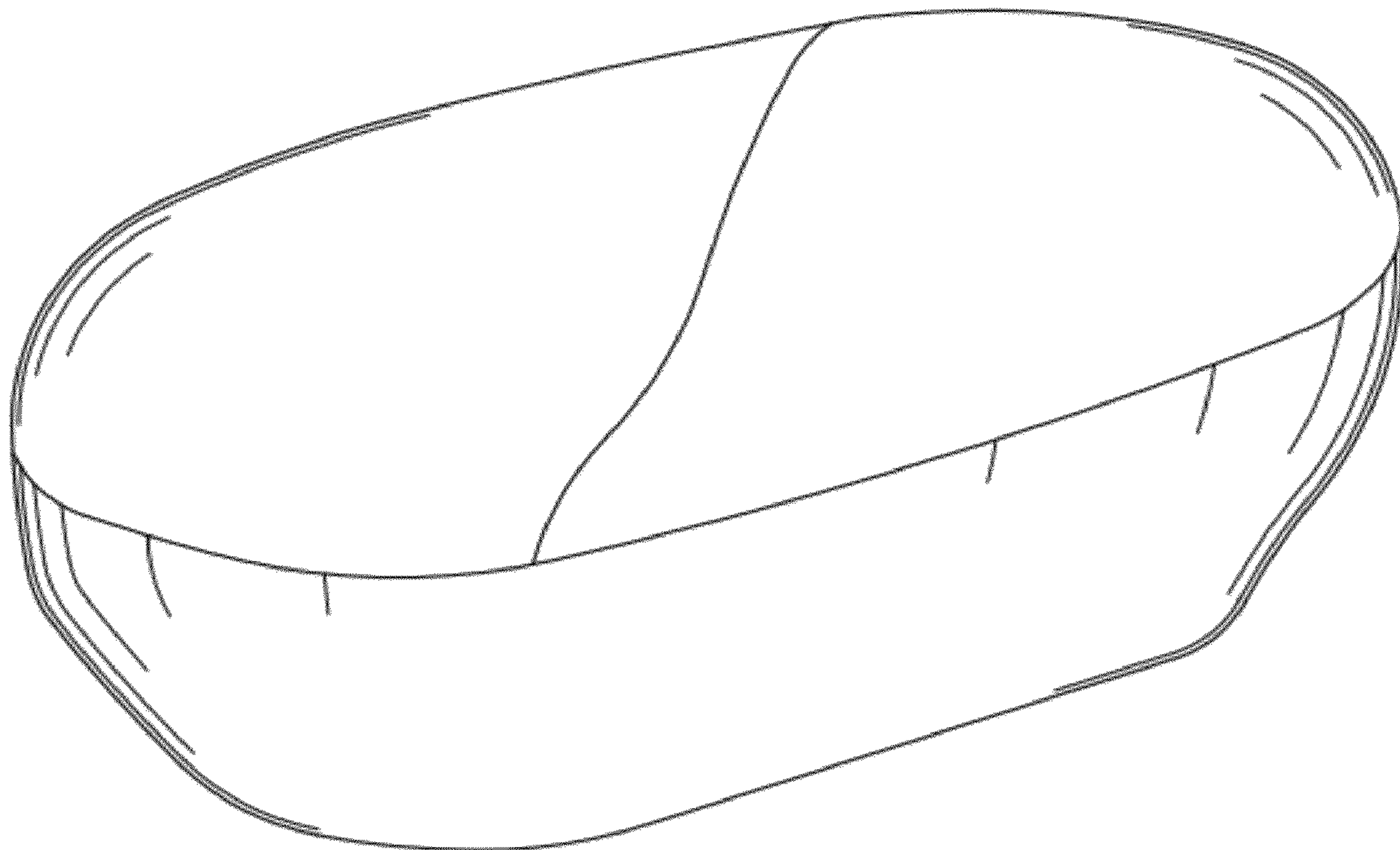

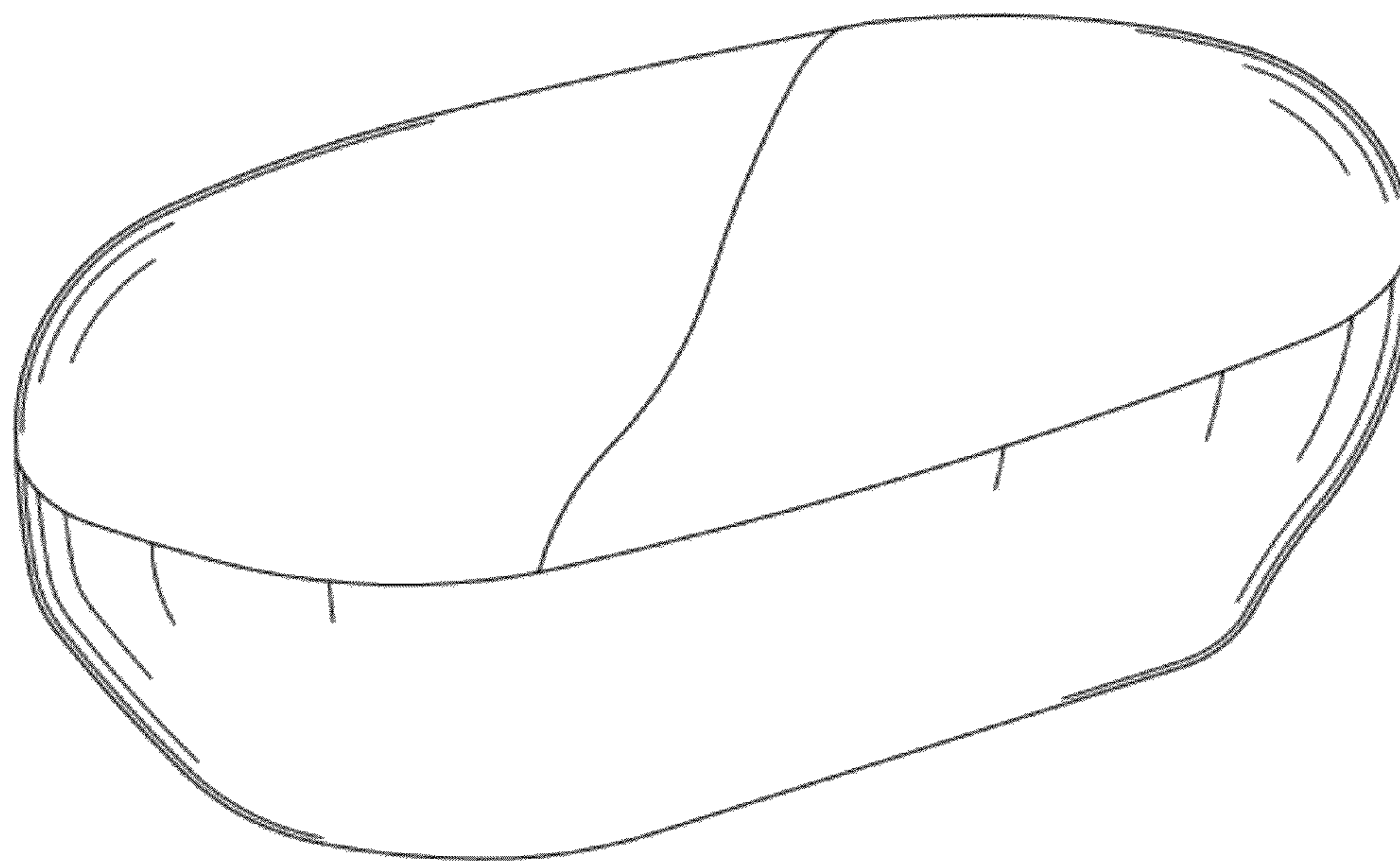

FIG. 1

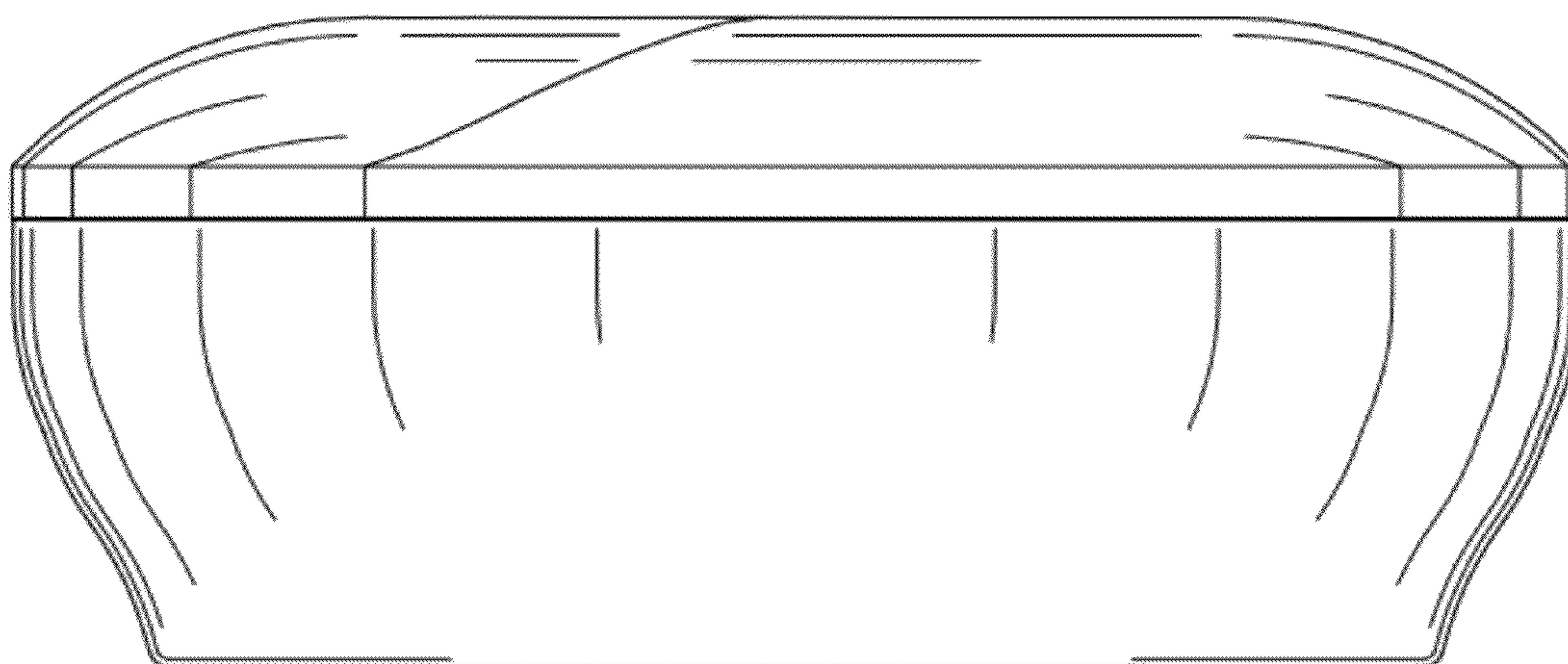

FIG. 2

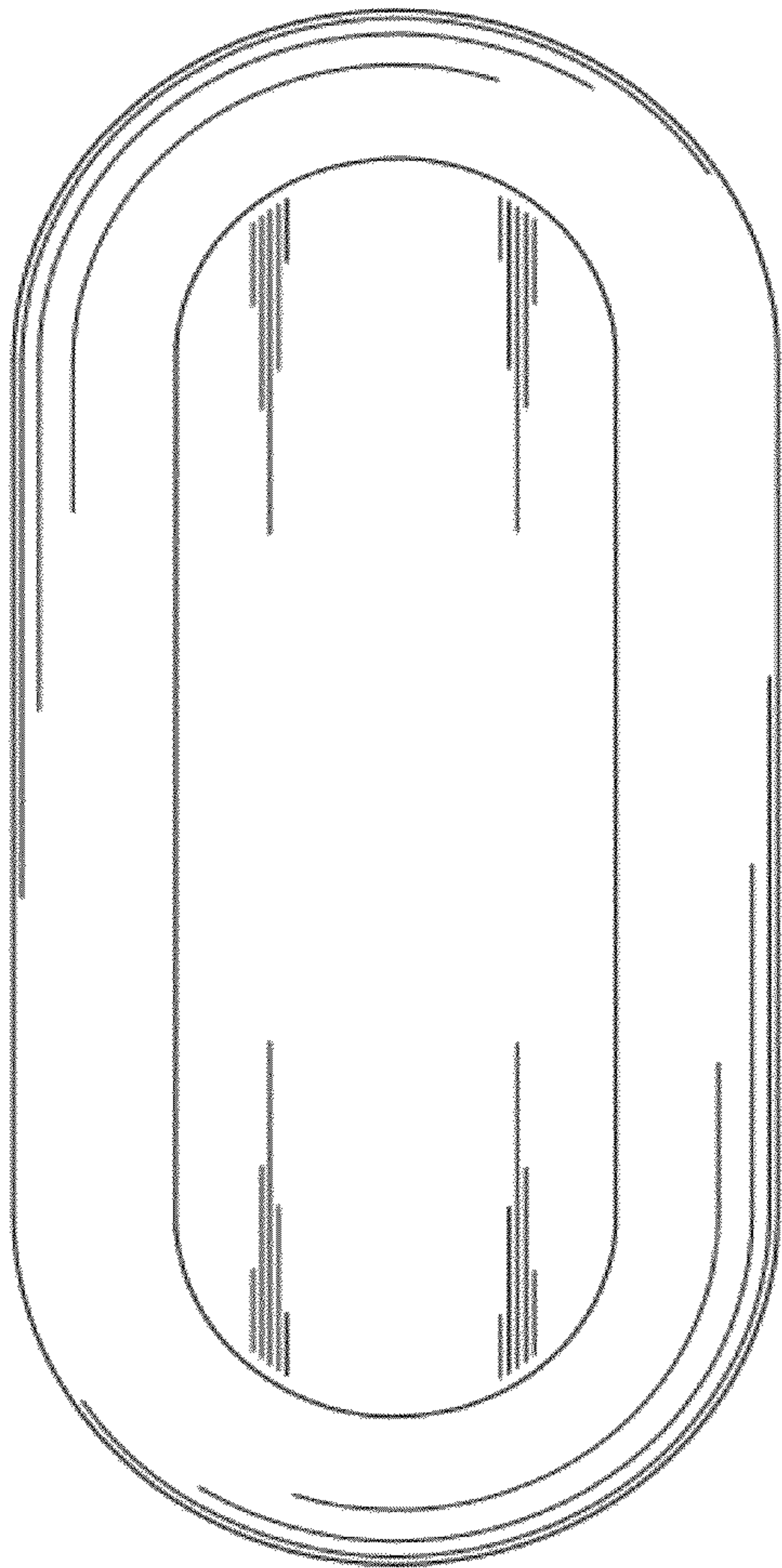

FIG. 3

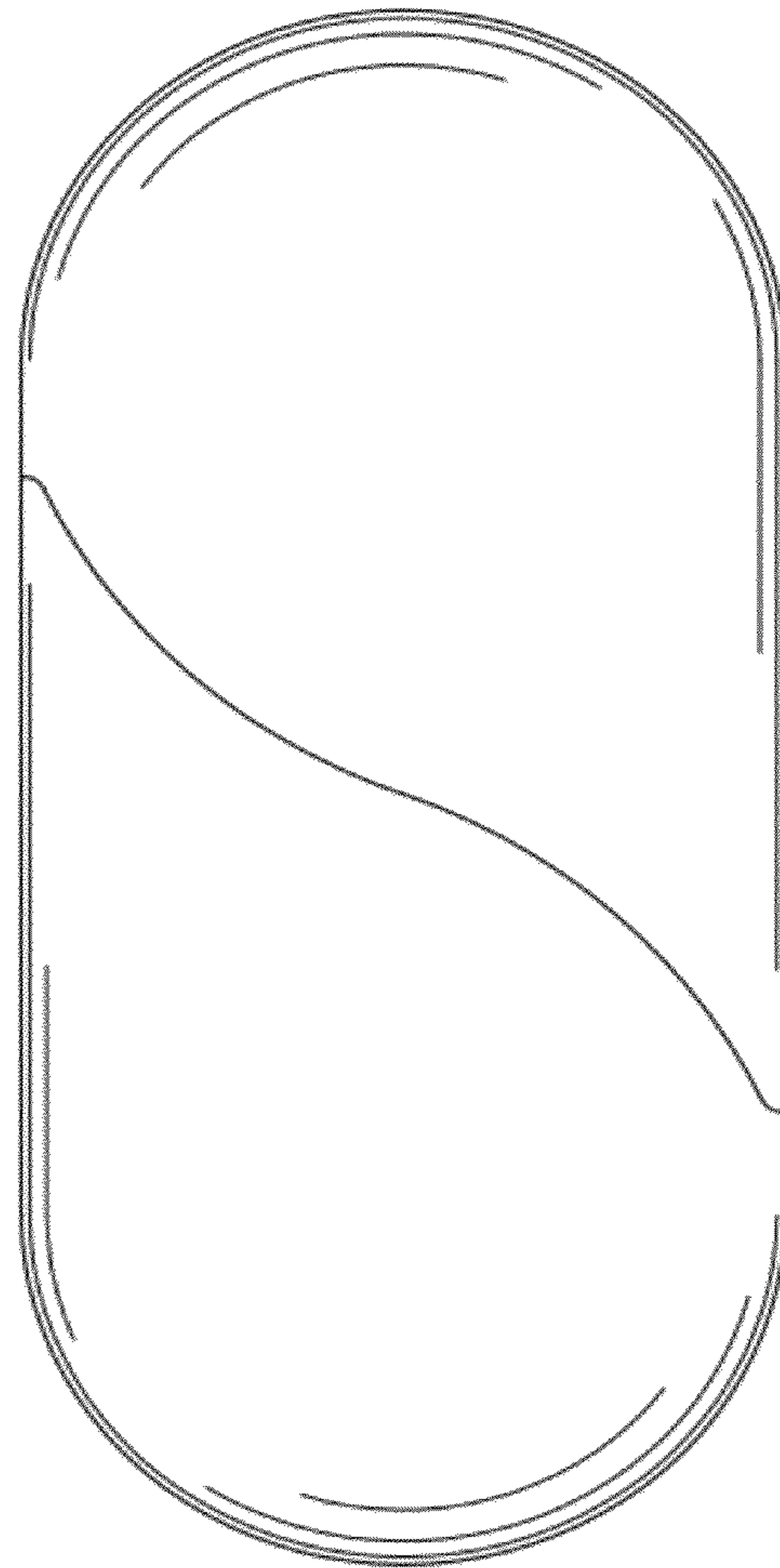

FIG. 4

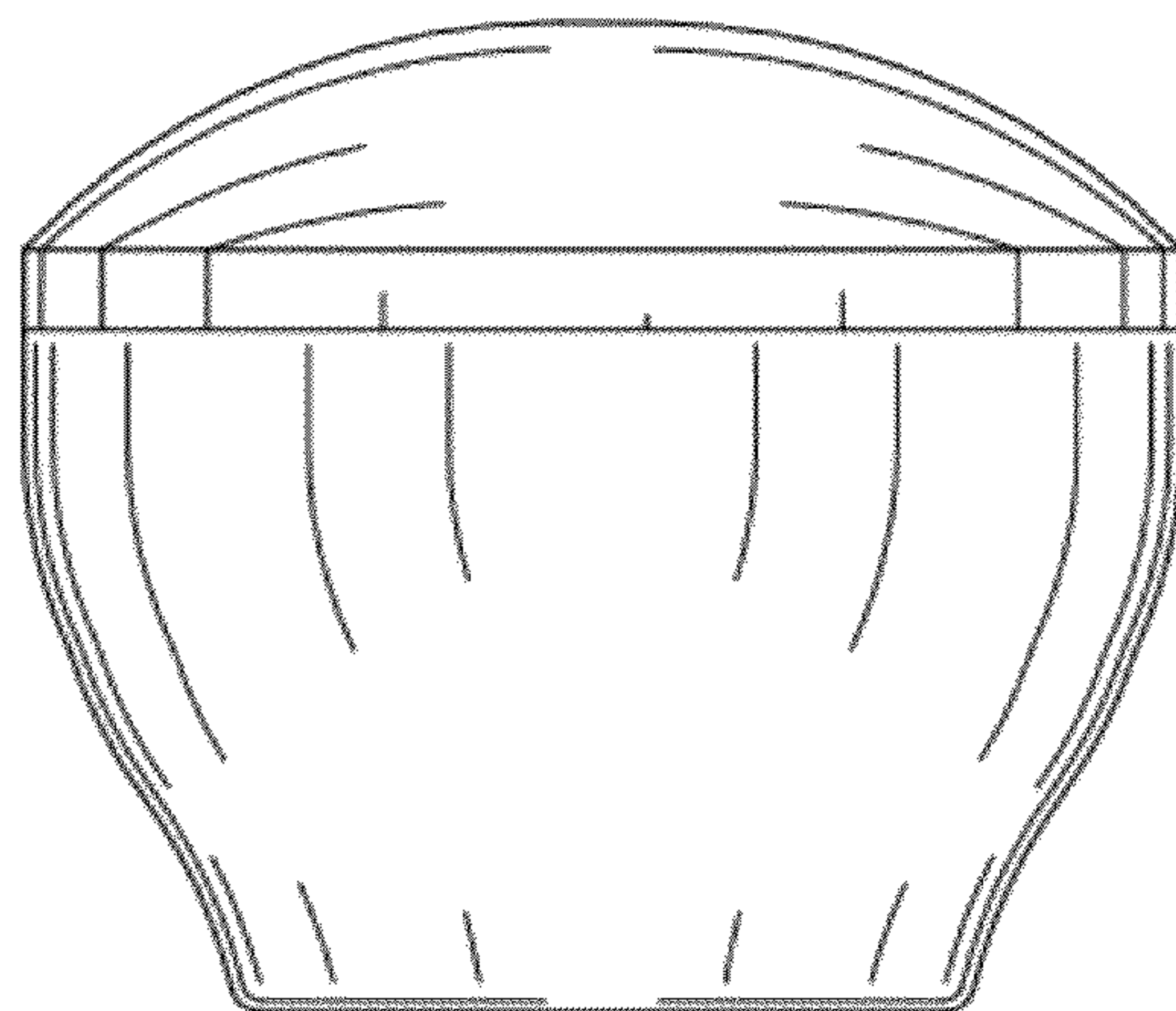

FIG. 5

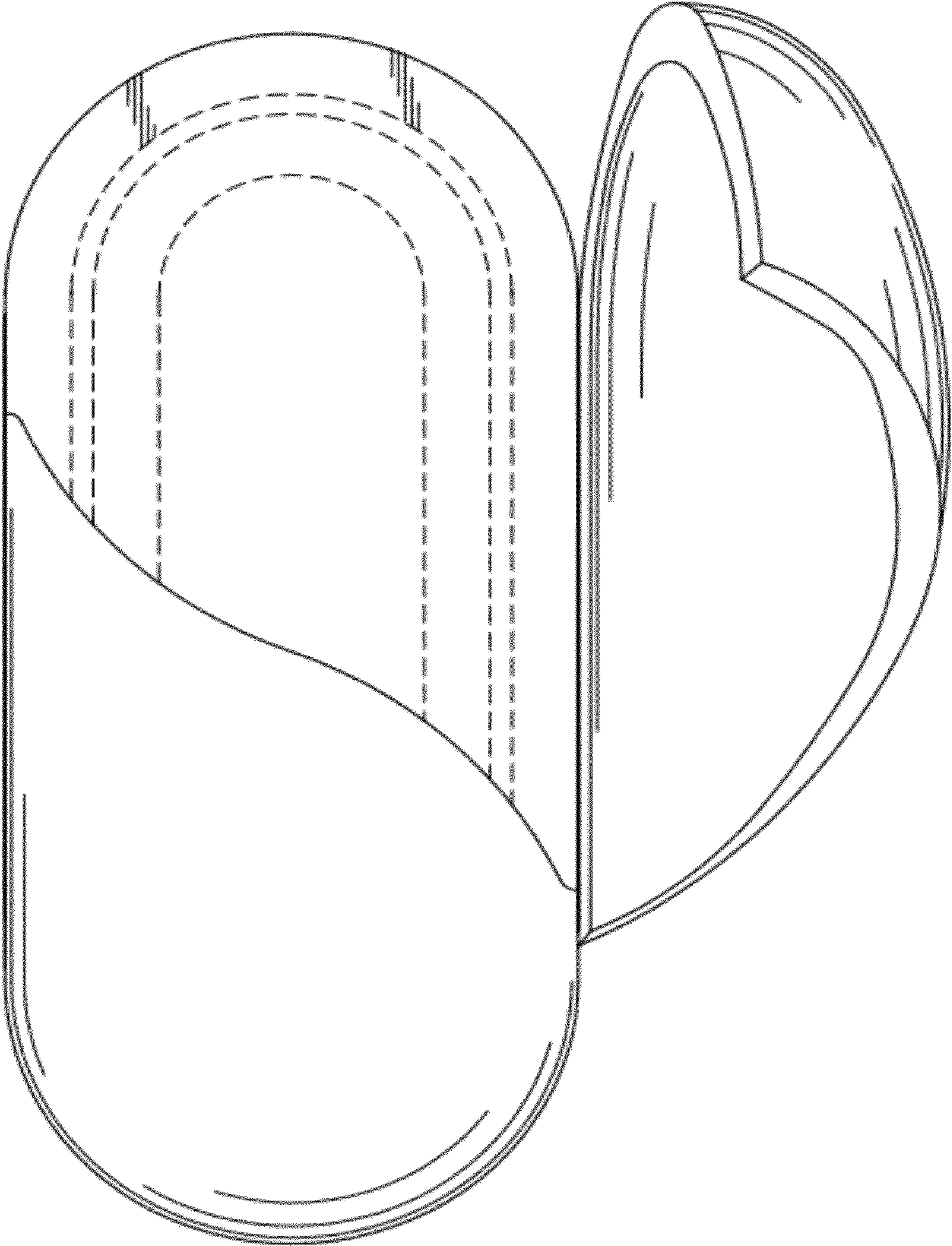

FIG. 6

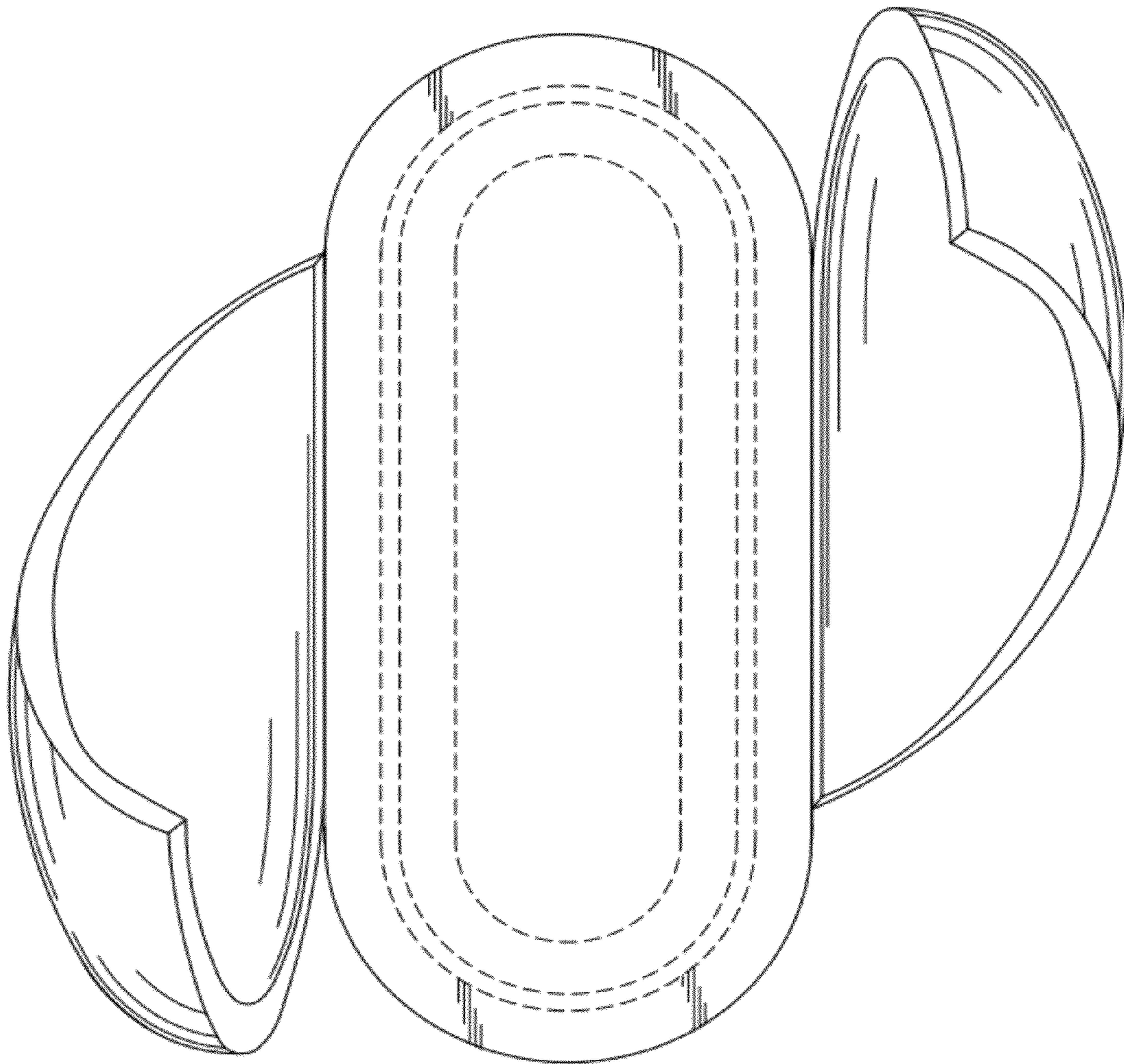

FIG. 7