



US00D672857S

(12) **United States Design Patent**
Yano et al.

(10) **Patent No.:** **US D672,857 S**

(45) **Date of Patent:** **** Dec. 18, 2012**

(54) **VENT CAP**

(75) Inventors: **Youzou Yano**, Osaka (JP); **Kou Uemura**, Osaka (JP)

(73) Assignee: **Nitto Denko Corporation**, Osaka (JP)

(**) Term: **14 Years**

(21) Appl. No.: **29/381,082**

(22) Filed: **Dec. 15, 2010**

(30) **Foreign Application Priority Data**

Jun. 15, 2010 (JP) 2010-014699

(51) **LOC (9) Cl.** **23-05**

(52) **U.S. Cl.** **D23/365**

(58) **Field of Classification Search** D23/365,
D23/209, 363, 358, 386, 354, 341, 364; 55/385.3,
55/502, 497, 506, 505, 521, 495, 422, 493,
55/DIG. 30; 210/435, 130, 136, 248, 339,
210/448, 452, 497.1; D15/5

See application file for complete search history.

(56) **References Cited**

U.S. PATENT DOCUMENTS

D317,965 S *	7/1991	Svensson	D23/209
D354,795 S *	1/1995	Heligman	D23/209
D378,744 S *	4/1997	Abrahamson et al.	D23/386
D394,312 S *	5/1998	Thompson	D23/386
D400,240 S *	10/1998	Thallemer et al.	D23/386
6,214,215 B1 *	4/2001	Berkey et al.	210/130
D520,596 S *	5/2006	Johnson et al.	D23/209
D553,238 S *	10/2007	Haggkvist	D23/386
D580,009 S *	11/2008	LeJeune	D23/209
D626,208 S *	10/2010	Clements	D23/386
D628,281 S *	11/2010	Bates et al.	D23/364
7,874,431 B2 *	1/2011	Eisengraeber-Pabst et al.	210/497.1
7,882,961 B2 *	2/2011	Menez et al.	210/435

* cited by examiner

Primary Examiner — David Muller

(74) *Attorney, Agent, or Firm* — Dennis R. Haszko

(57) **CLAIM**

The ornamental design for a vent cap, as shown and described.

DESCRIPTION

FIG. 1 is top perspective view of the vent cap;
FIG. 2 is a bottom perspective view thereof;
FIG. 3 is a front view thereof;
FIG. 4 is a rear view thereof;
FIG. 5 is a plan view thereof;
FIG. 6 is a bottom view thereof;
FIG. 7 is a right side view thereof;
FIG. 8 is a left side view thereof;
FIG. 9 is a cross-sectional view thereof along line 9-9 of FIG. 3;
FIG. 10 is a cross-sectional view thereof along line 10-10 of FIG. 3;
FIG. 11 is a perspective reference view of the vent cap in use together with a vent filter and a housing;
FIG. 12 is a cross-sectional reference view of the vent cap in use together with a vent filter and a housing; and,
FIG. 13 is a cross-sectional reference view of the vent cap in use together with a vent filter.

The portions shown in evenly broken lines do not form part of the design. The alternating long and short dashed lines show a boundary between claimed and unclaimed features.

The article for which a design right is sought is a vent cap which is used while being placed on a vent filter attached to a housing for a headlight for a vehicle, an outdoor lightning device, a communication device and the like. For example, as illustrated in the reference which shows the usage state, by placing the present article on the vent filter, decrease in the ventilating function, which is caused by adhesion of dust and liquid to the filter, can be prevented, and furthermore as illustrated in the reference FIG. 13 which shows the usage state, the ventilating passage as indicated by arrows can be secured.

1 Claim, 7 Drawing Sheets

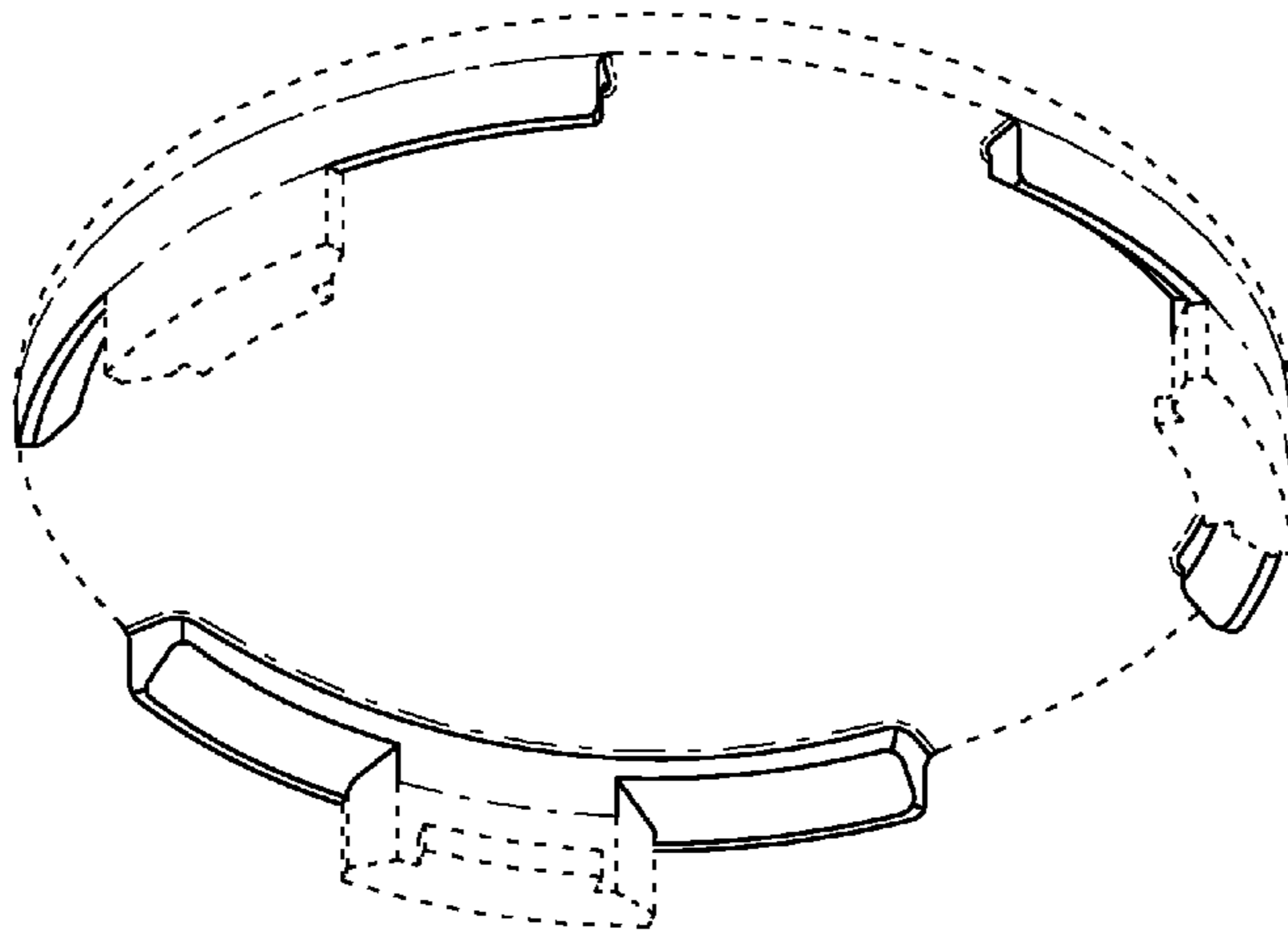

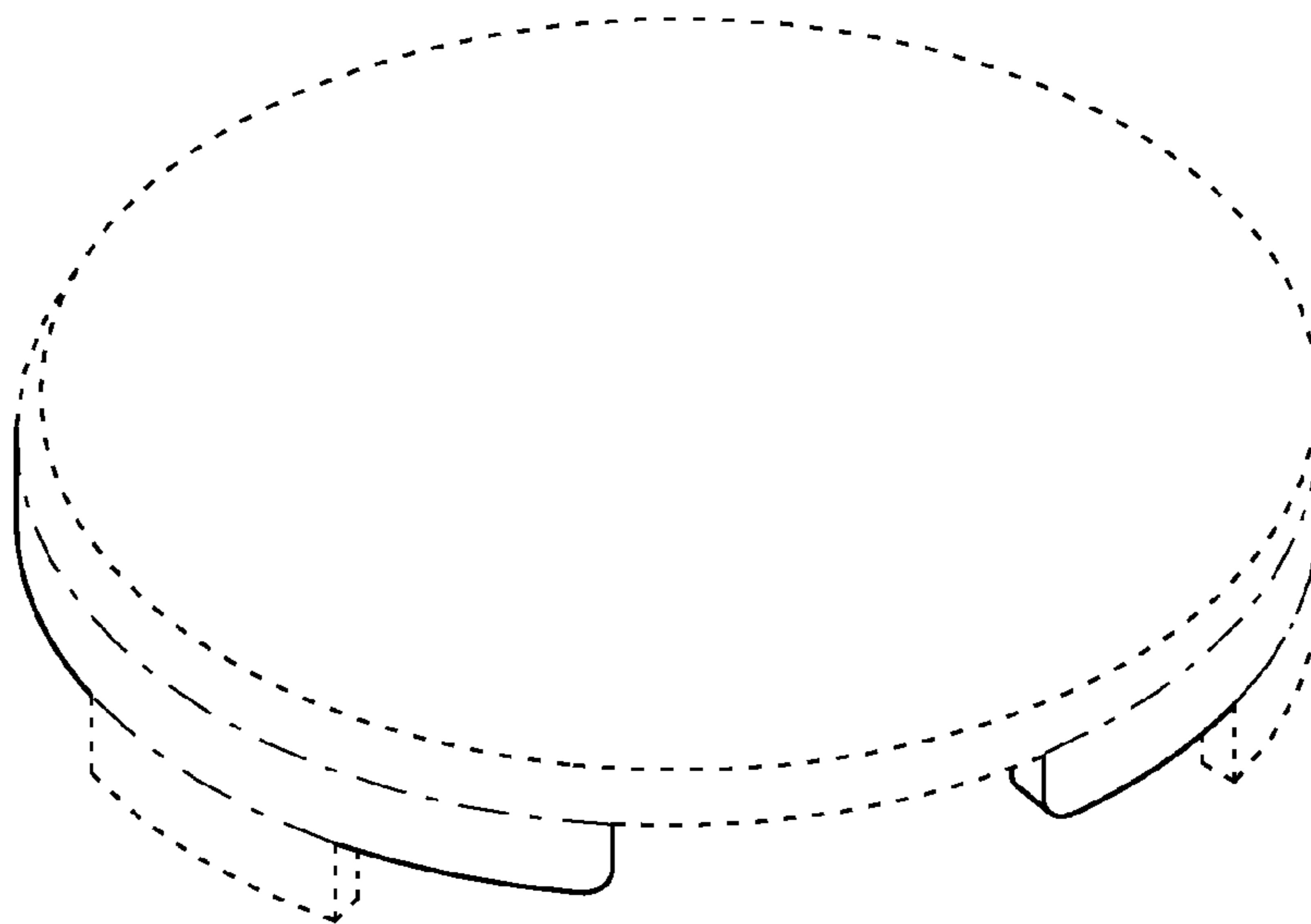

FIG. 1

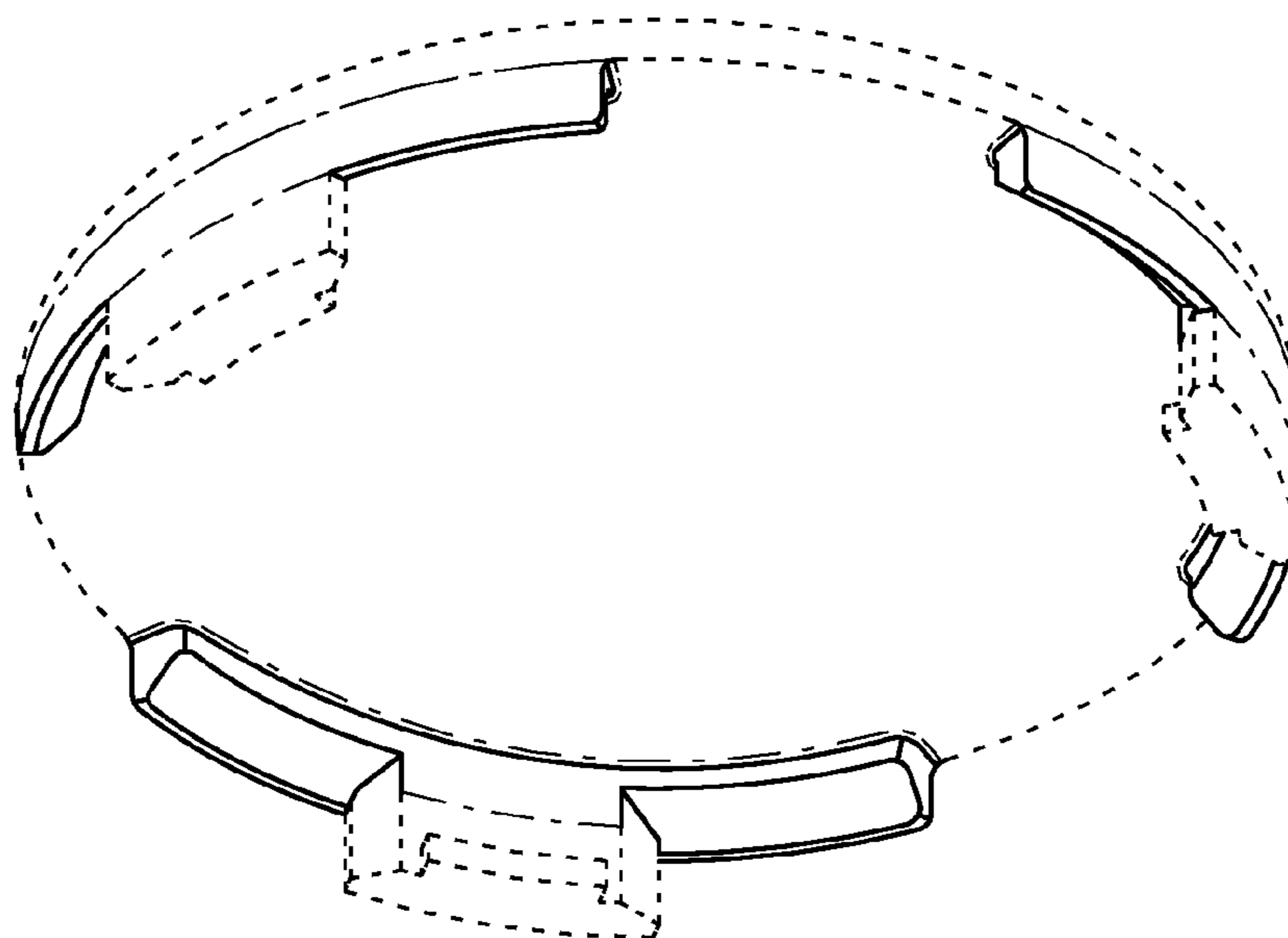

FIG. 2

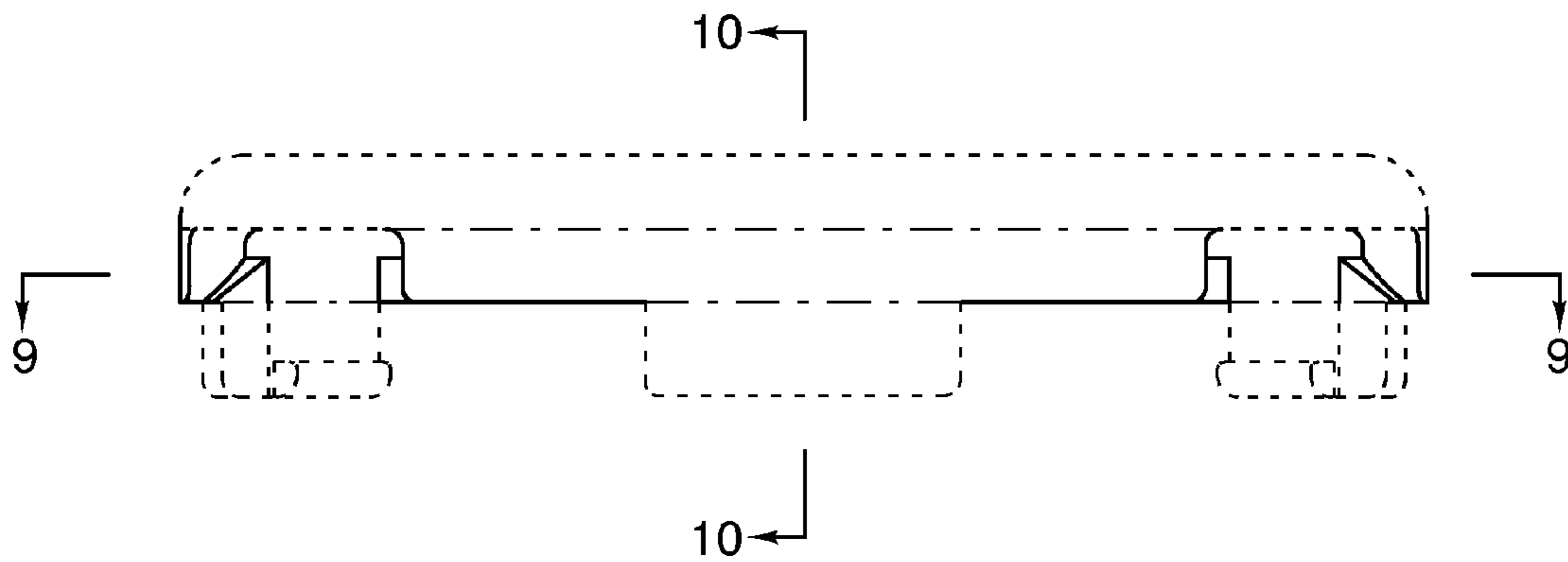

FIG.3

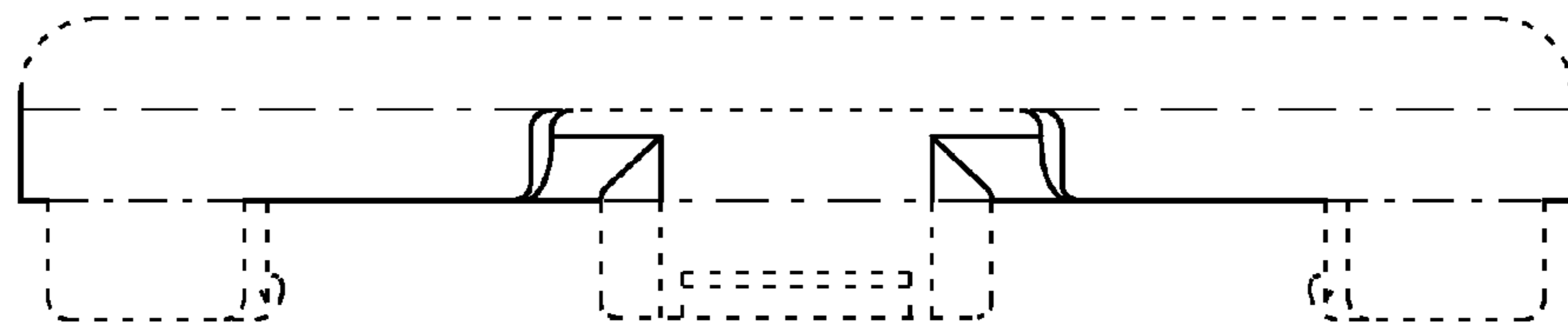

FIG.4

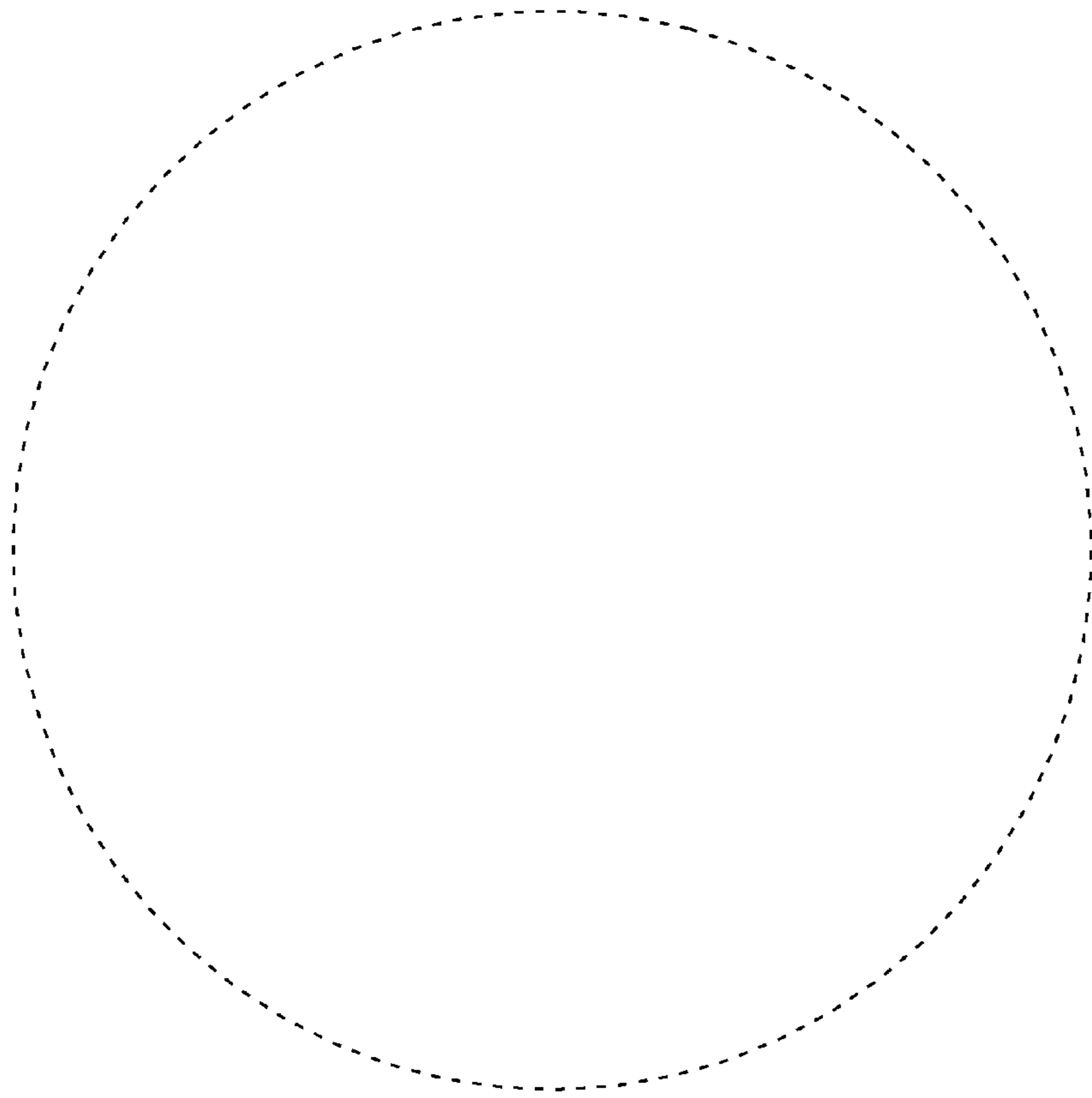

FIG. 5

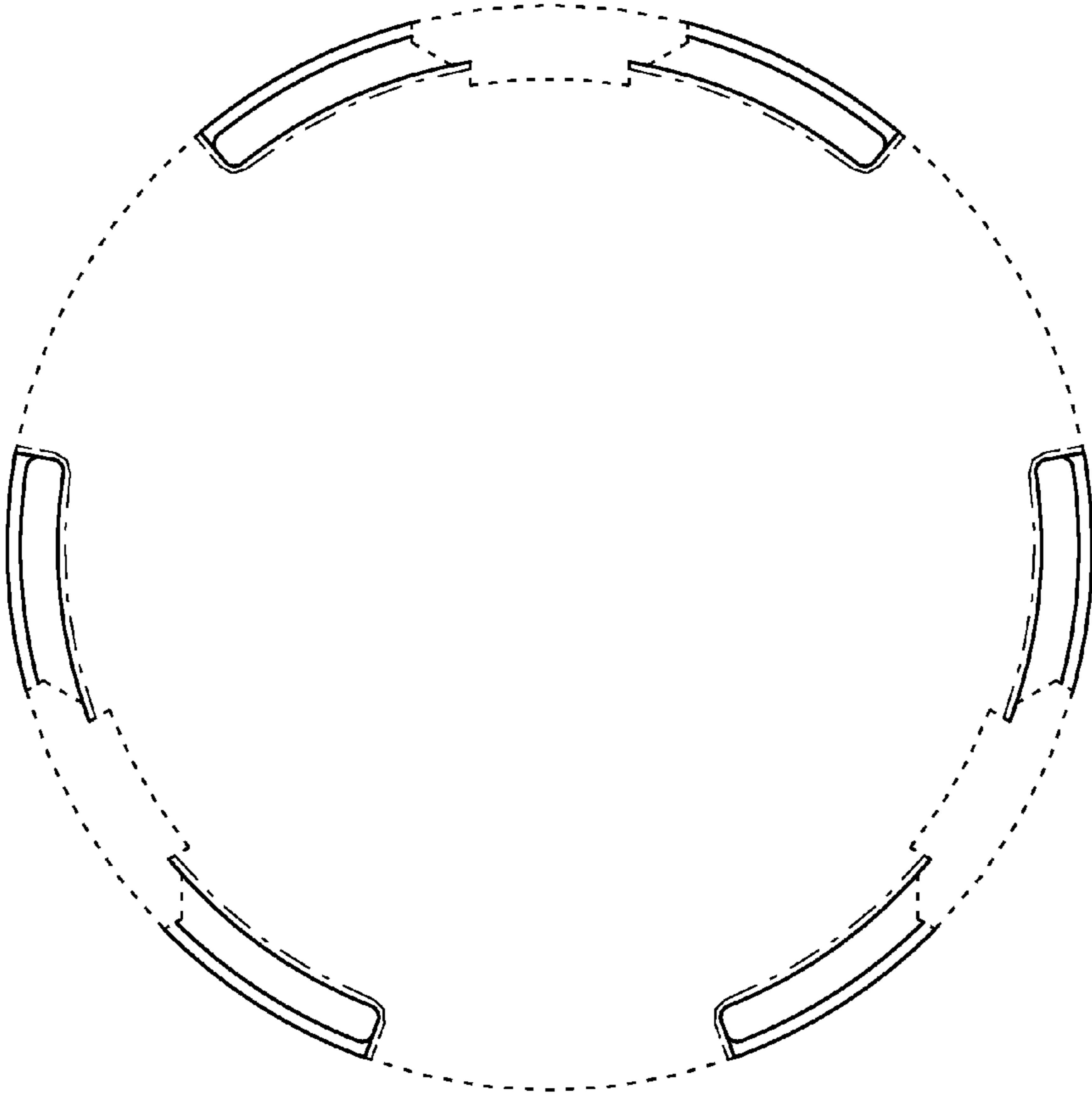

FIG. 6

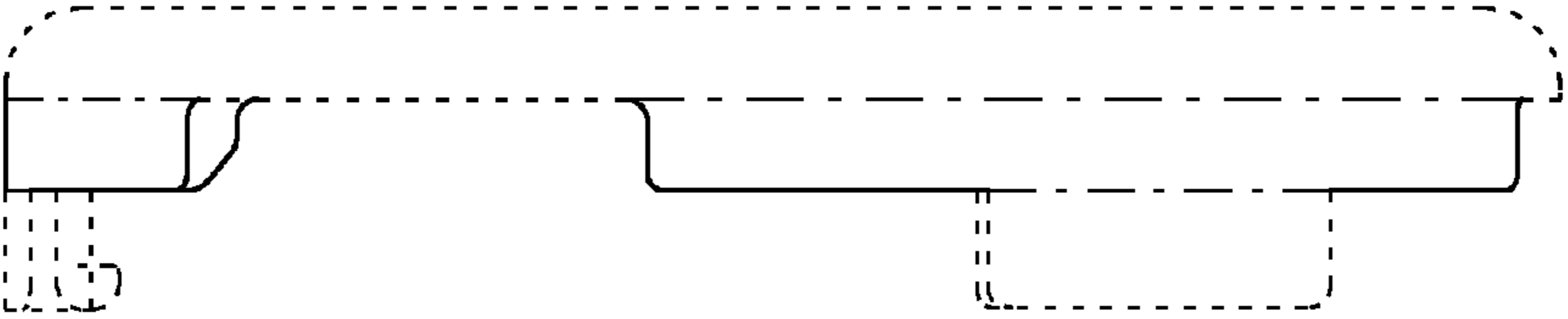

FIG. 7

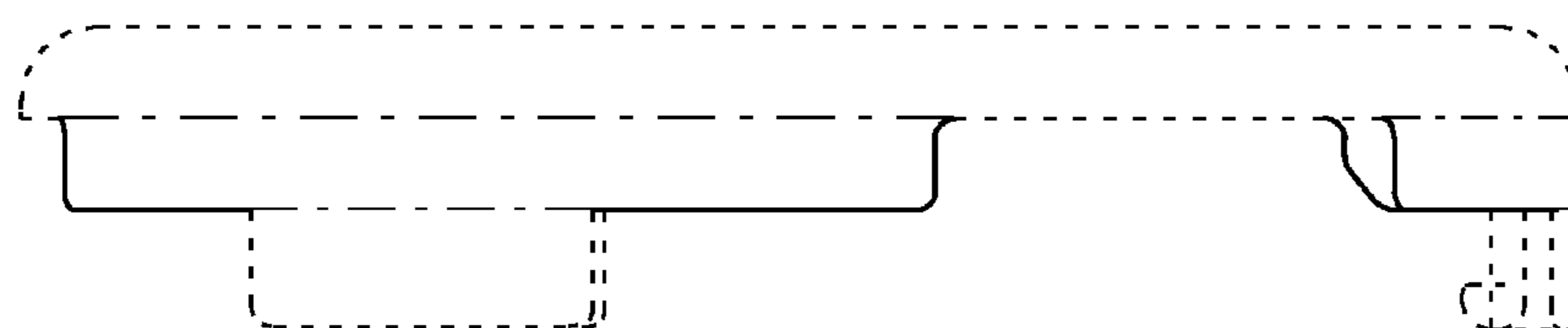

FIG. 8

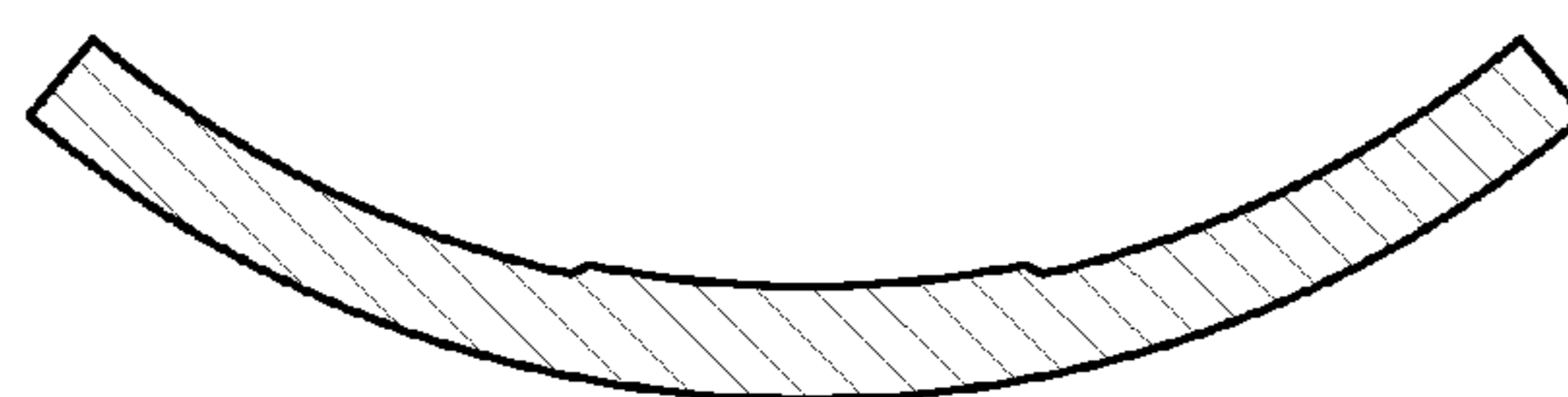
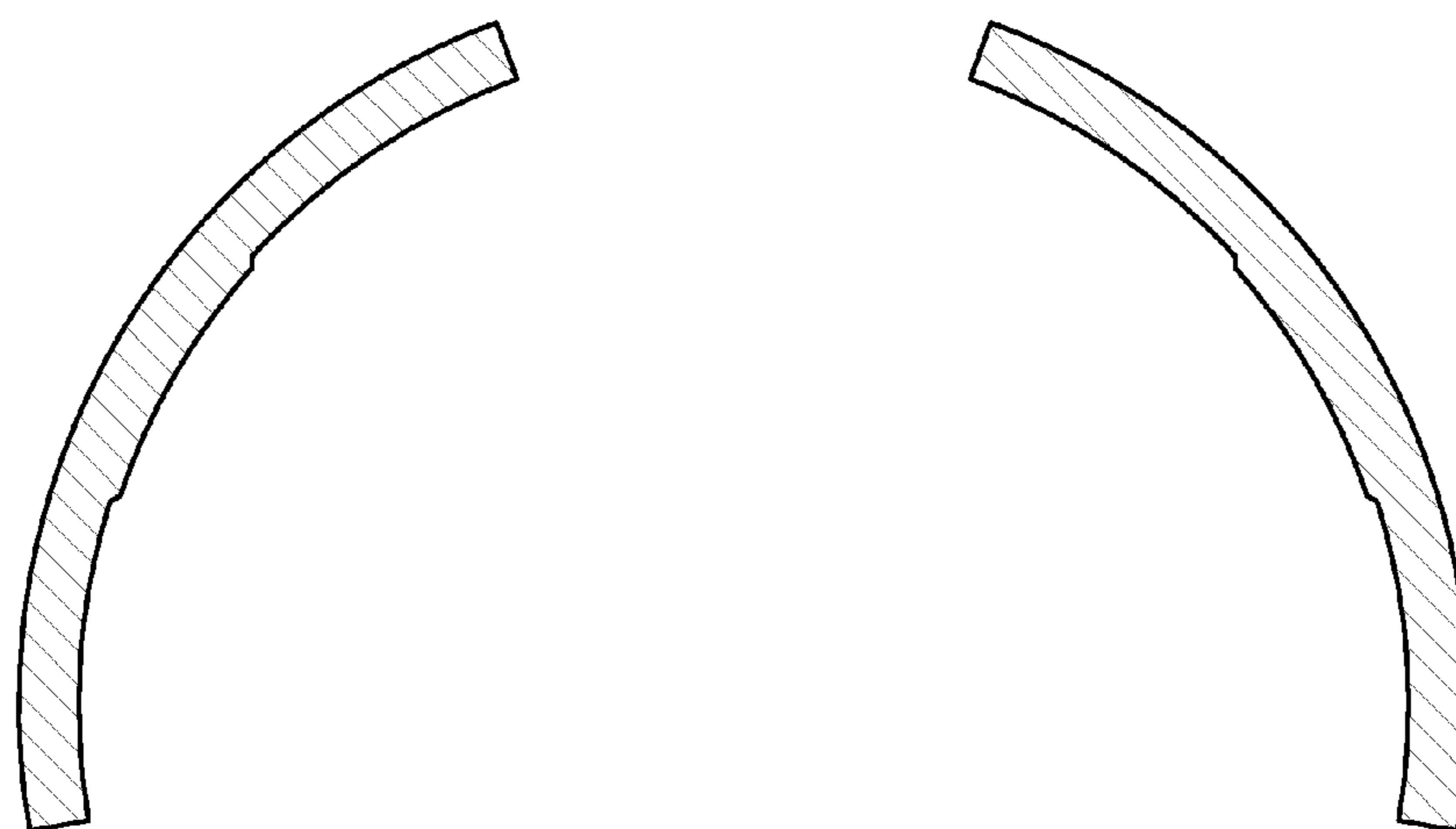

FIG. 9

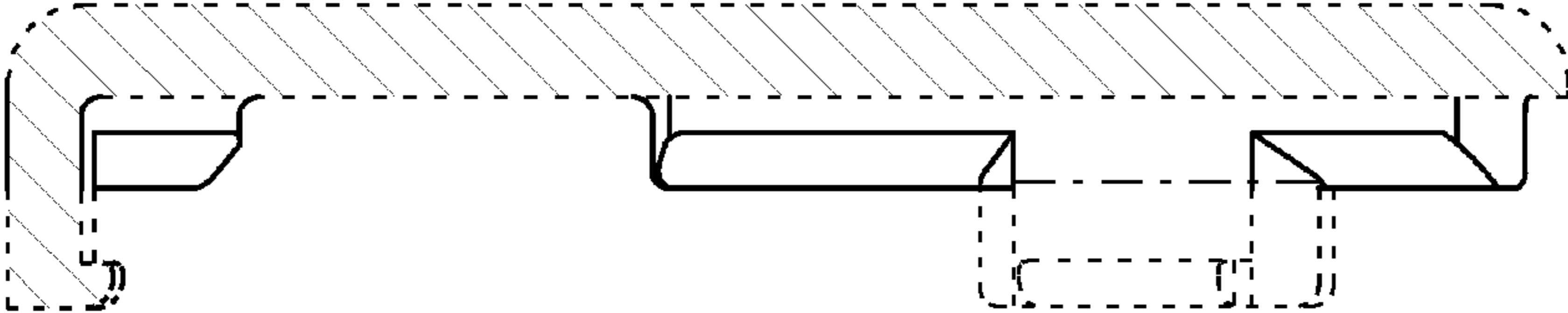

FIG.10

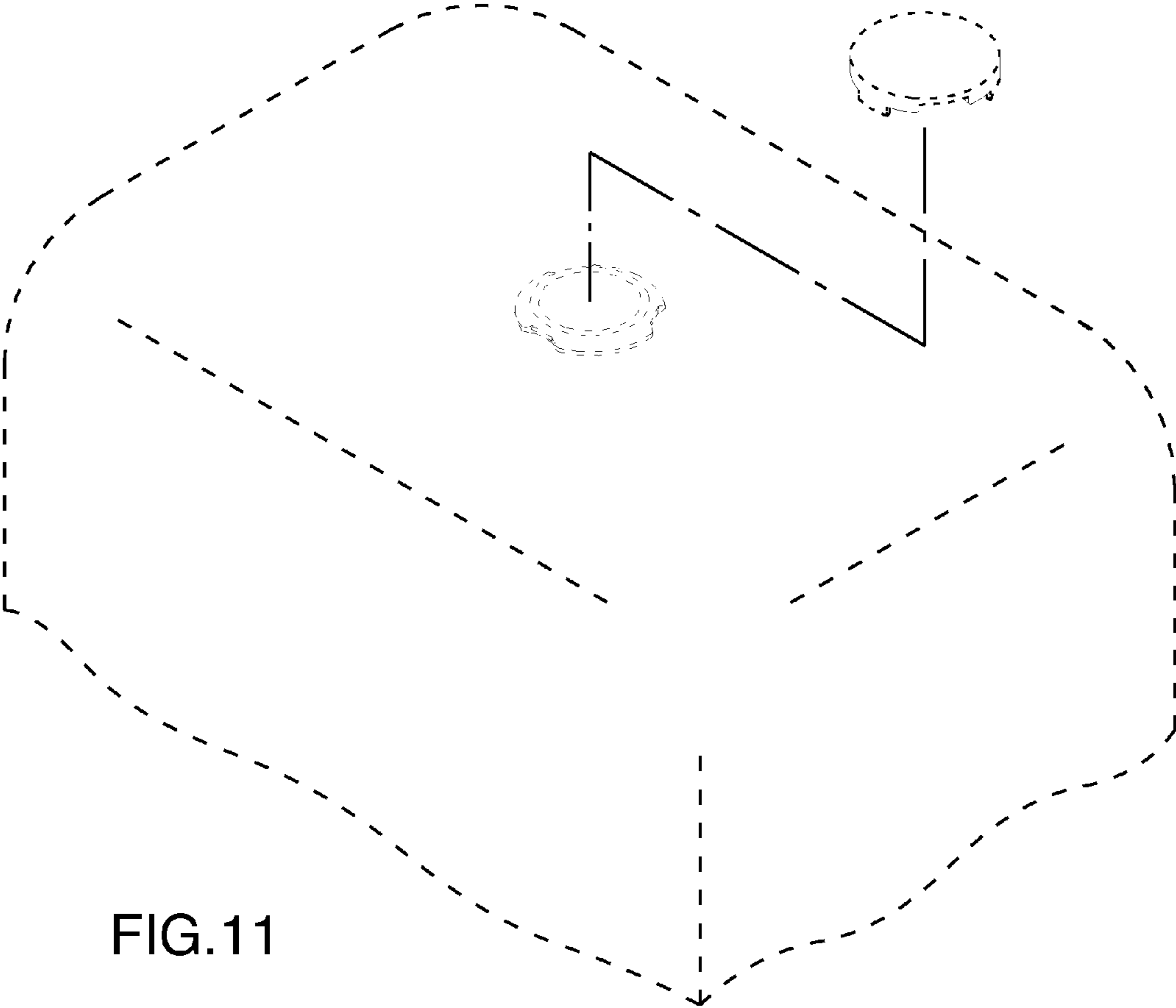

FIG.11

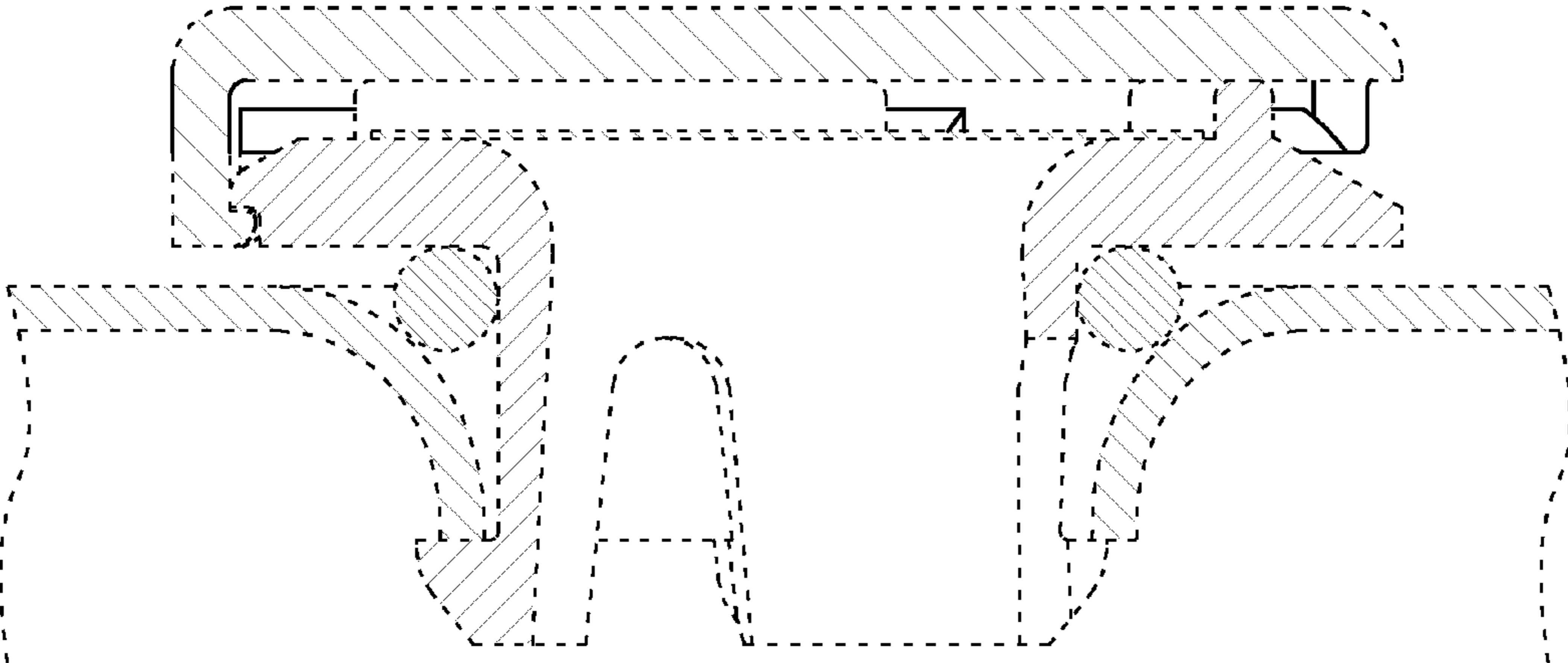

FIG.12

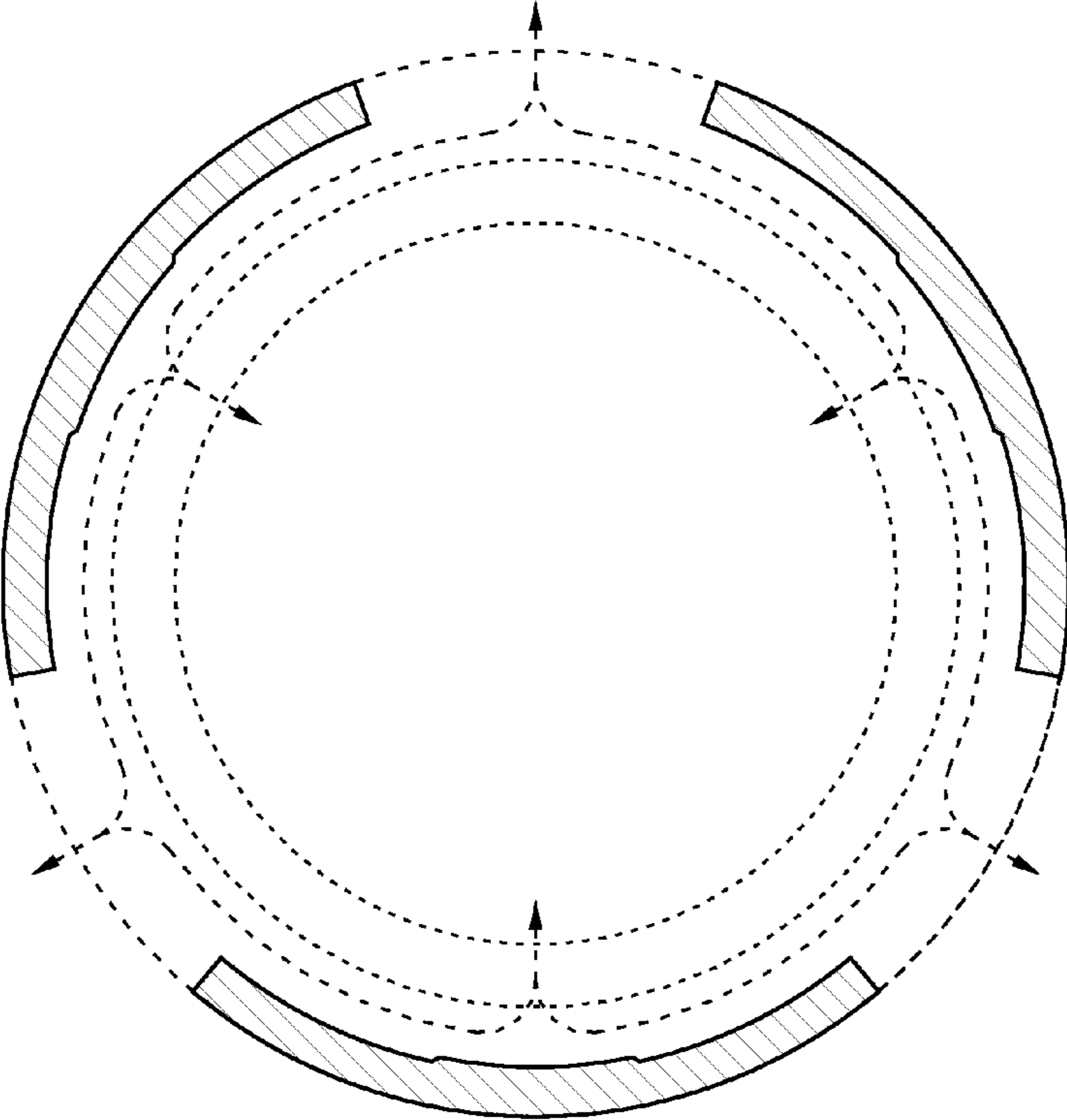

FIG.13

UNITED STATES PATENT AND TRADEMARK OFFICE
CERTIFICATE OF CORRECTION

PATENT NO. : D672,857 S
APPLICATION NO. : 29/381082
DATED : December 18, 2012
INVENTOR(S) : Youzou Yano et al.

Page 1 of 2

It is certified that error appears in the above-identified patent and that said Letters Patent is hereby corrected as shown below:

The sheet of drawings consisting of figures 12 and 13 should be deleted to appear as per attached
figs. 12 and 13.

Signed and Sealed this
Nineteenth Day of February, 2013



Teresa Stanek Rea
Acting Director of the United States Patent and Trademark Office

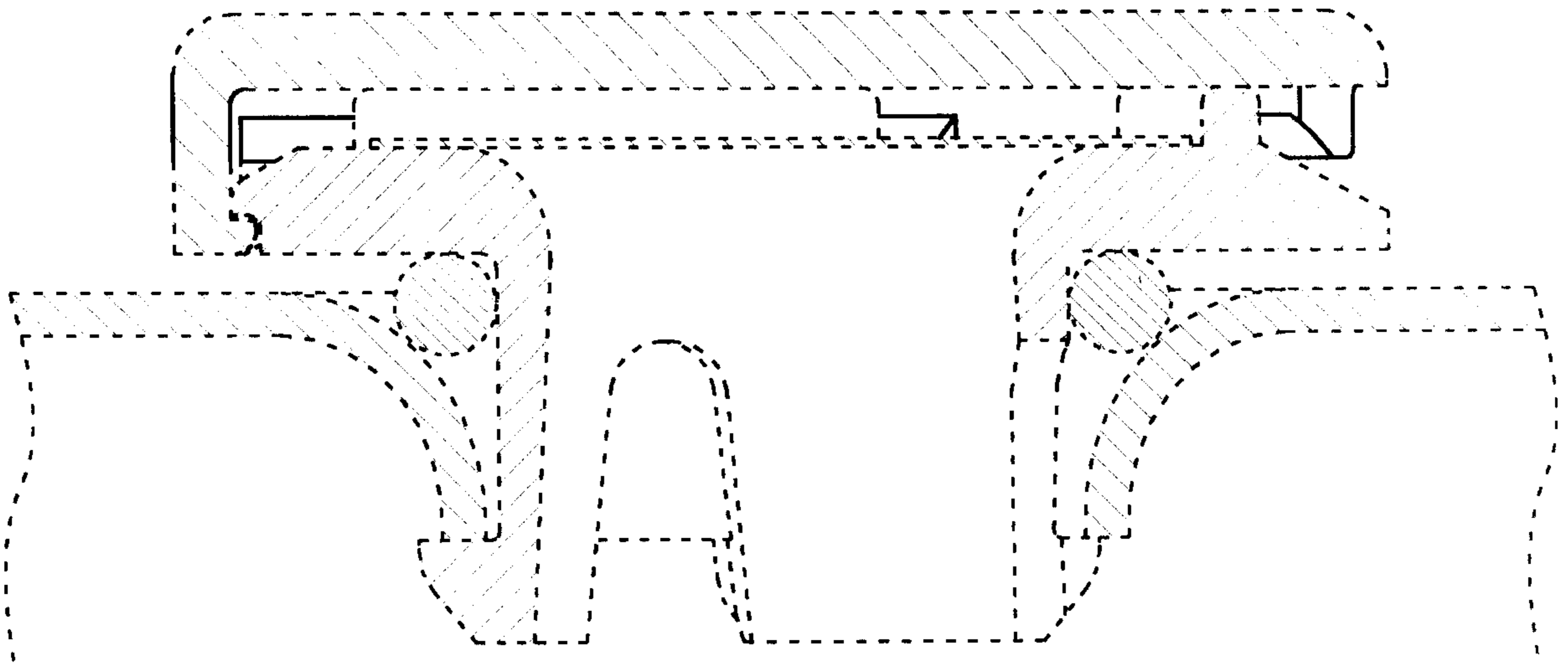

FIG. 12

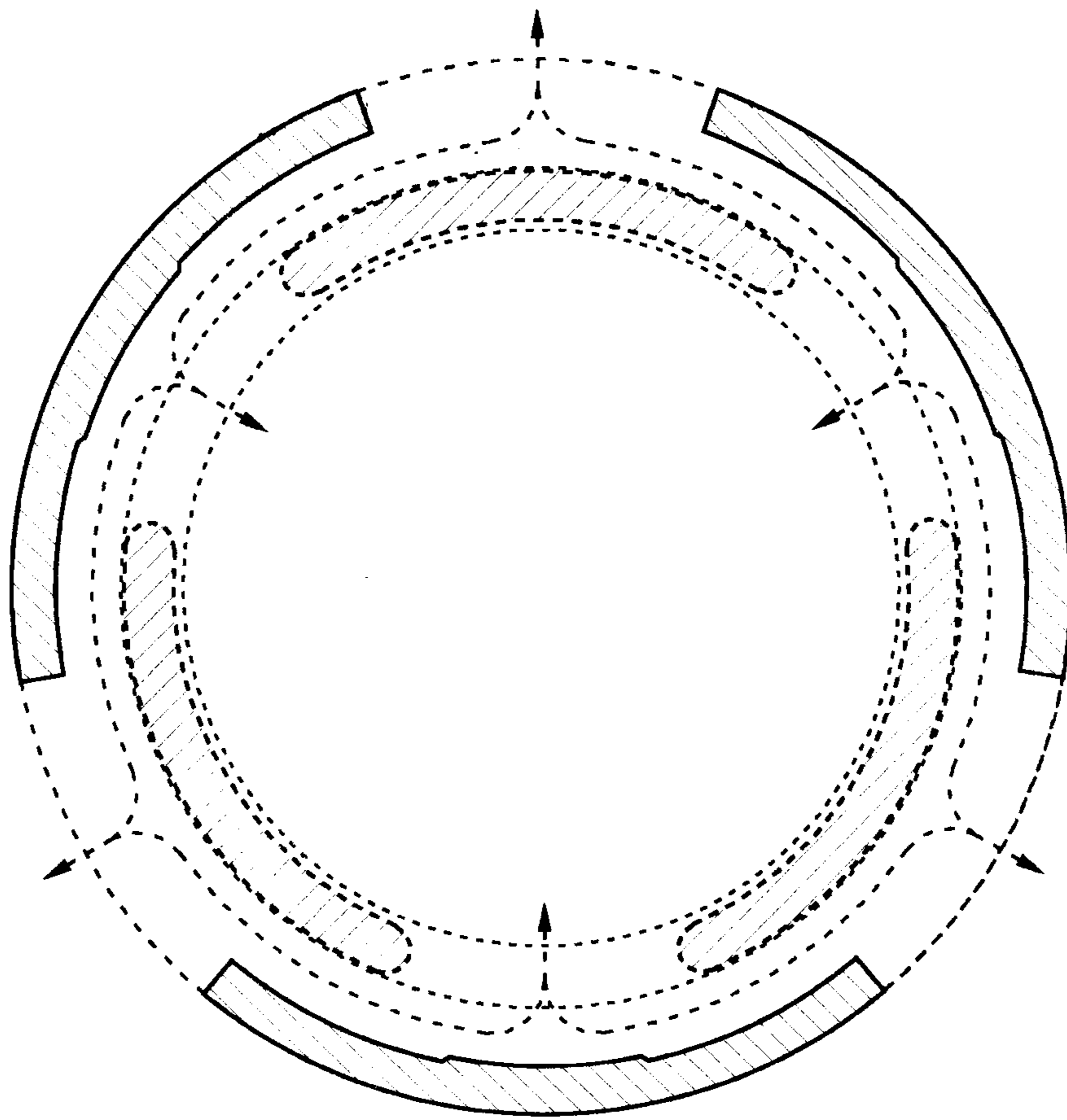

FIG. 13

UNITED STATES PATENT AND TRADEMARK OFFICE
CERTIFICATE OF CORRECTION

PATENT NO. : D672,857 S
APPLICATION NO. : 29/381082
DATED : December 18, 2012
INVENTOR(S) : Youzou Yano et al.

Page 1 of 2

It is certified that error appears in the above-identified patent and that said Letters Patent is hereby corrected as shown below:

In the Drawings

Please replace drawing sheet 1 of the patent (which includes Figure 2) with the attached corrected drawing sheet (which includes Figure 2).

Signed and Sealed this
Twenty-fifth Day of August, 2015



Michelle K. Lee
Director of the United States Patent and Trademark Office

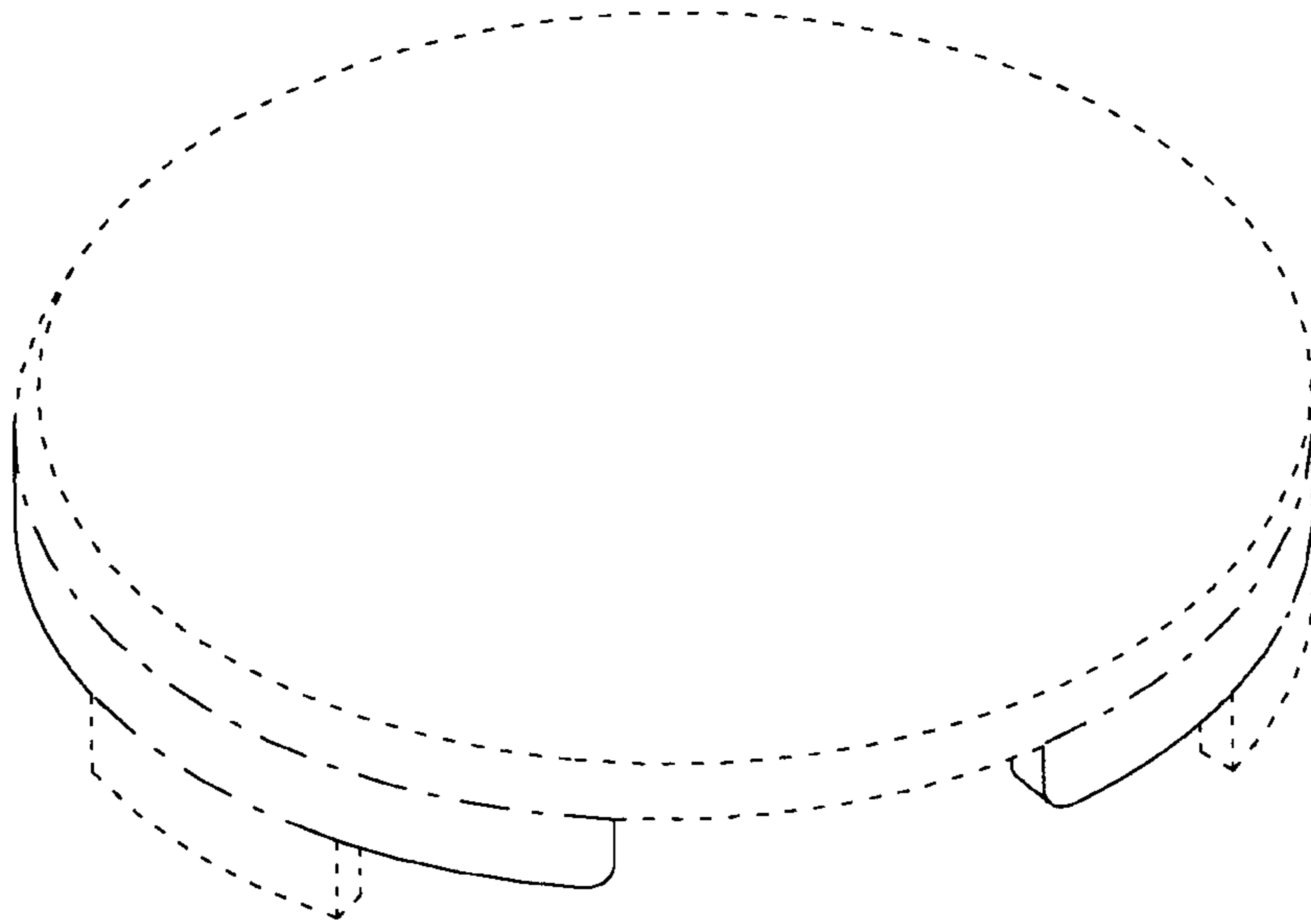

FIG.1

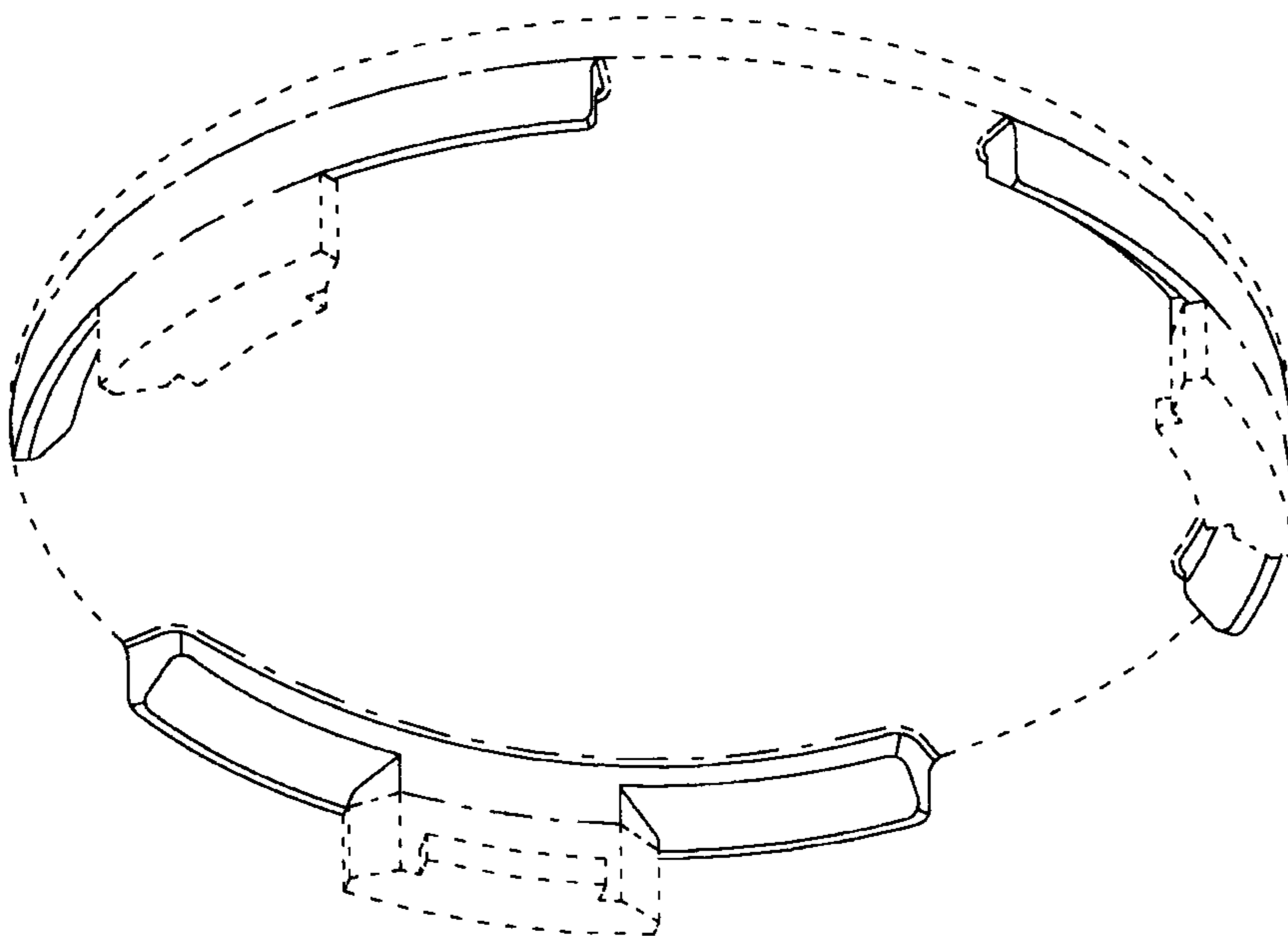

FIG.2

UNITED STATES PATENT AND TRADEMARK OFFICE
CERTIFICATE OF CORRECTION

PATENT NO. : D672,857 S
APPLICATION NO. : 29/381082
DATED : December 18, 2012
INVENTOR(S) : Youzou Yano et al.

Page 1 of 3

It is certified that error appears in the above-identified patent and that said Letters Patent is hereby corrected as shown below:

The Title page, showing the illustrative figure, should be deleted and substitute therefor the attached Title page.

In the Drawings

Delete drawings sheets 1 of 7 and substitute therefor the drawing sheet, consisting of figs. 1-2 as shown on the attached page.

This certificate supersedes the Certificate of Correction issued August 25, 2015.

Signed and Sealed this
Third Day of November, 2015



Michelle K. Lee
Director of the United States Patent and Trademark Office

(12) **United States Design Patent**
Yano et al.

(10) **Patent No.:** **US D672,857 S**
(45) **Date of Patent:** **** Dec. 18, 2012**

(54) **VENT CAP**

(75) Inventors: **Youzou Yano**, Osaka (JP); **Kou Uemura**, Osaka (JP)

(73) Assignee: **Nitto Denko Corporation**, Osaka (JP)

(**) **Term:** **14 Years**

(21) **Appl. No.:** **29/381,082**

(22) **Filed:** **Dec. 15, 2010**

(30) **Foreign Application Priority Data**

Jun. 15, 2010 (JP) 2010-014699

(51) **LOC (9) Cl.** **23-05**

(52) **U.S. Cl.** **D23/365**

(58) **Field of Classification Search** D23/365,
D23/209, 363, 358, 386, 354, 341, 364; 55/385.3,
55/502, 497, 506, 505, 521, 495, 422, 493,
55/DIG. 30; 210/435, 130, 136, 248, 339,
210/448, 452, 497.1; D15/5

See application file for complete search history.

(56) **References Cited**

U.S. PATENT DOCUMENTS

D317,965 S *	7/1991	Svensson	D23 209
D354,795 S *	1/1995	Heligman	D23 209
D378,744 S *	4/1997	Abrahamson et al.	D23 386
D394,312 S *	5/1998	Thompson	D23 386
D400,240 S *	10/1998	Thallemer et al.	D23 386
6,214,215 B1 *	4/2001	Berkey et al.	210 130
D520,596 S *	5/2006	Johnson et al.	D23 209
D553,238 S *	10/2007	Haggkvist	D23 386
D580,009 S *	11/2008	Leleune	D23 209
D626,208 S *	10/2010	Clements	D23 386
D628,281 S *	11/2010	Bates et al.	D23 364
7,874,431 B2 *	1/2011	Eisengraeber-Pabst et al.	210 497.1
7,882,961 B2 *	2/2011	Menez et al.	210 435

* cited by examiner

Primary Examiner — David Muller

(74) *Attorney, Agent, or Firm* — Dennis R. Haszko

(57) **CLAIM**

The ornamental design for a vent cap, as shown and described.

DESCRIPTION

FIG. 1 is top perspective view of the vent cap;
FIG. 2 is a bottom perspective view thereof;
FIG. 3 is a front view thereof;
FIG. 4 is a rear view thereof;
FIG. 5 is a plan view thereof;
FIG. 6 is a bottom view thereof;
FIG. 7 is a right side view thereof;
FIG. 8 is a left side view thereof;
FIG. 9 is a cross-sectional view thereof along line 9-9 of FIG. 3;
FIG. 10 is a cross-sectional view thereof along line 10-10 of FIG. 3;
FIG. 11 is a perspective reference view of the vent cap in use together with a vent filter and a housing;
FIG. 12 is a cross-sectional reference view of the vent cap in use together with a vent filter and a housing; and
FIG. 13 is a cross-sectional reference view of the vent cap in use together with a vent filter.
The portions shown in evenly broken lines do not form part of the design. The alternating long and short dashed lines show a boundary between claimed and unclaimed features.
The article for which a design right is sought is a vent cap which is used while being placed on a vent filter attached to a housing for a headlight for a vehicle, an outdoor lighting device, a communication device and the like. For example, as illustrated in the reference which shows the usage state, by placing the present article on the vent filter, decrease in the ventilating function, which is caused by adhesion of dust and liquid to the filter, can be prevented, and furthermore as illustrated in the reference FIG. 13 which shows the usage state, the ventilating passage as indicated by arrows can be secured.

1 Claim, 7 Drawing Sheets

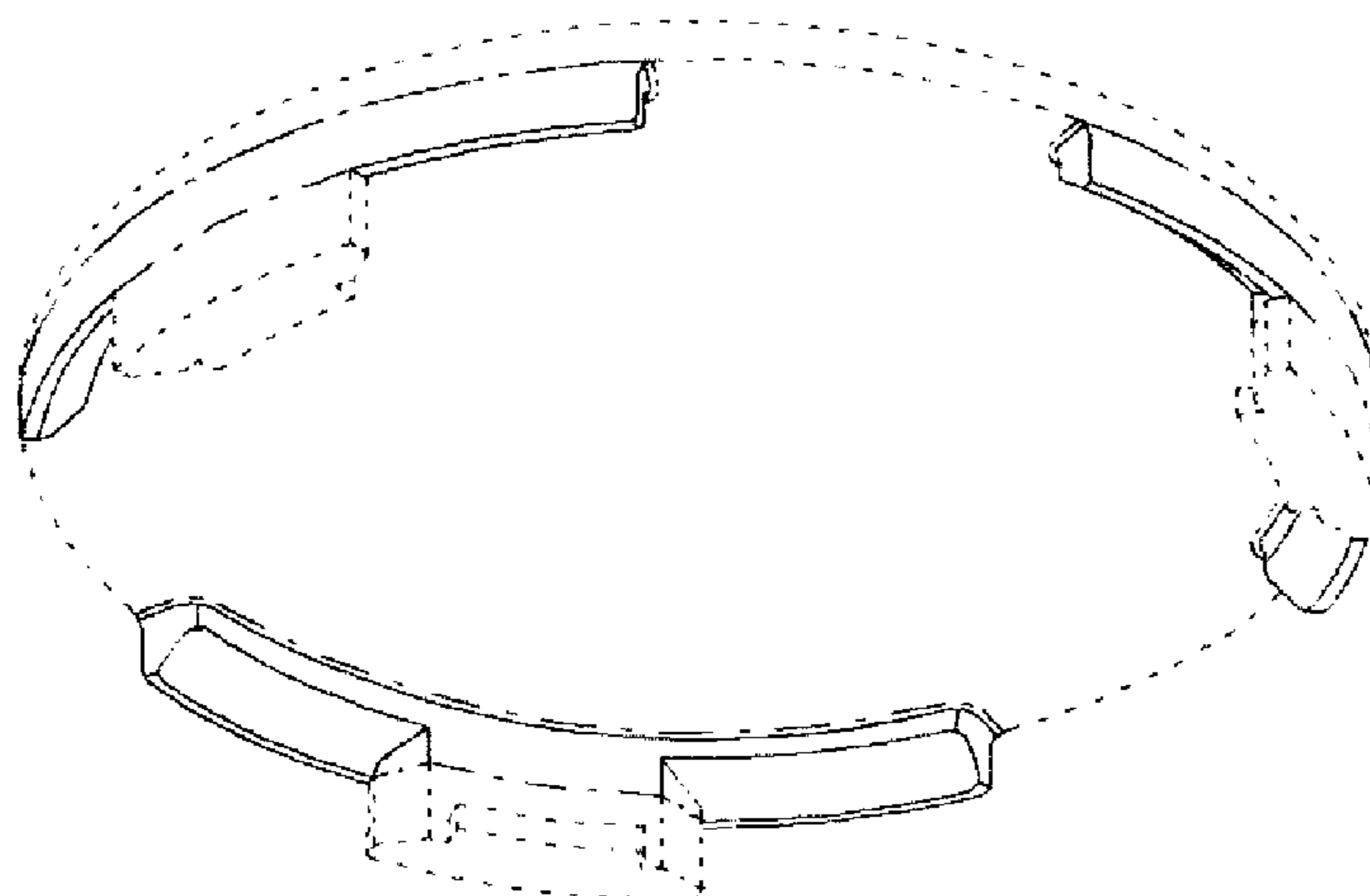

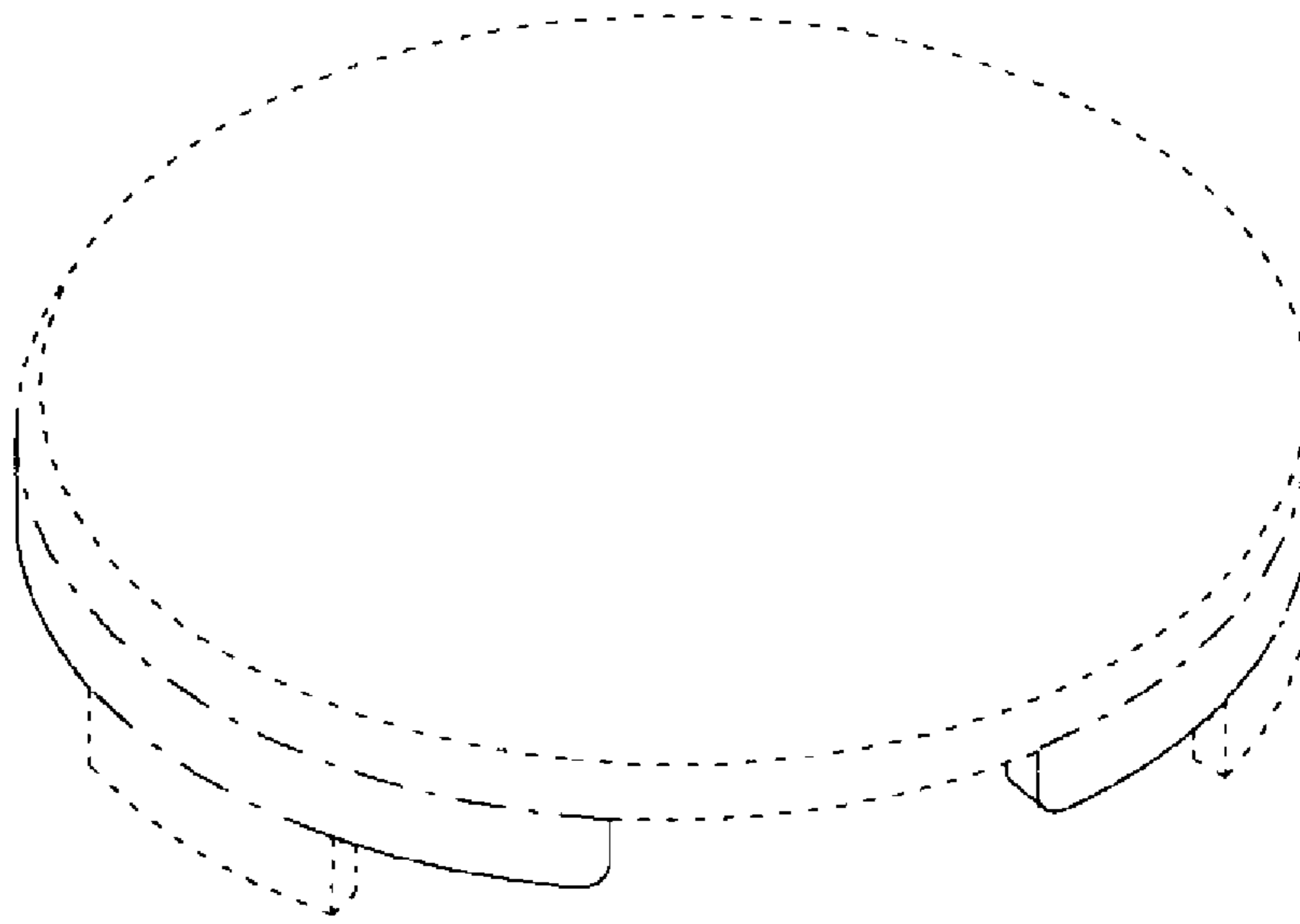

FIG.1

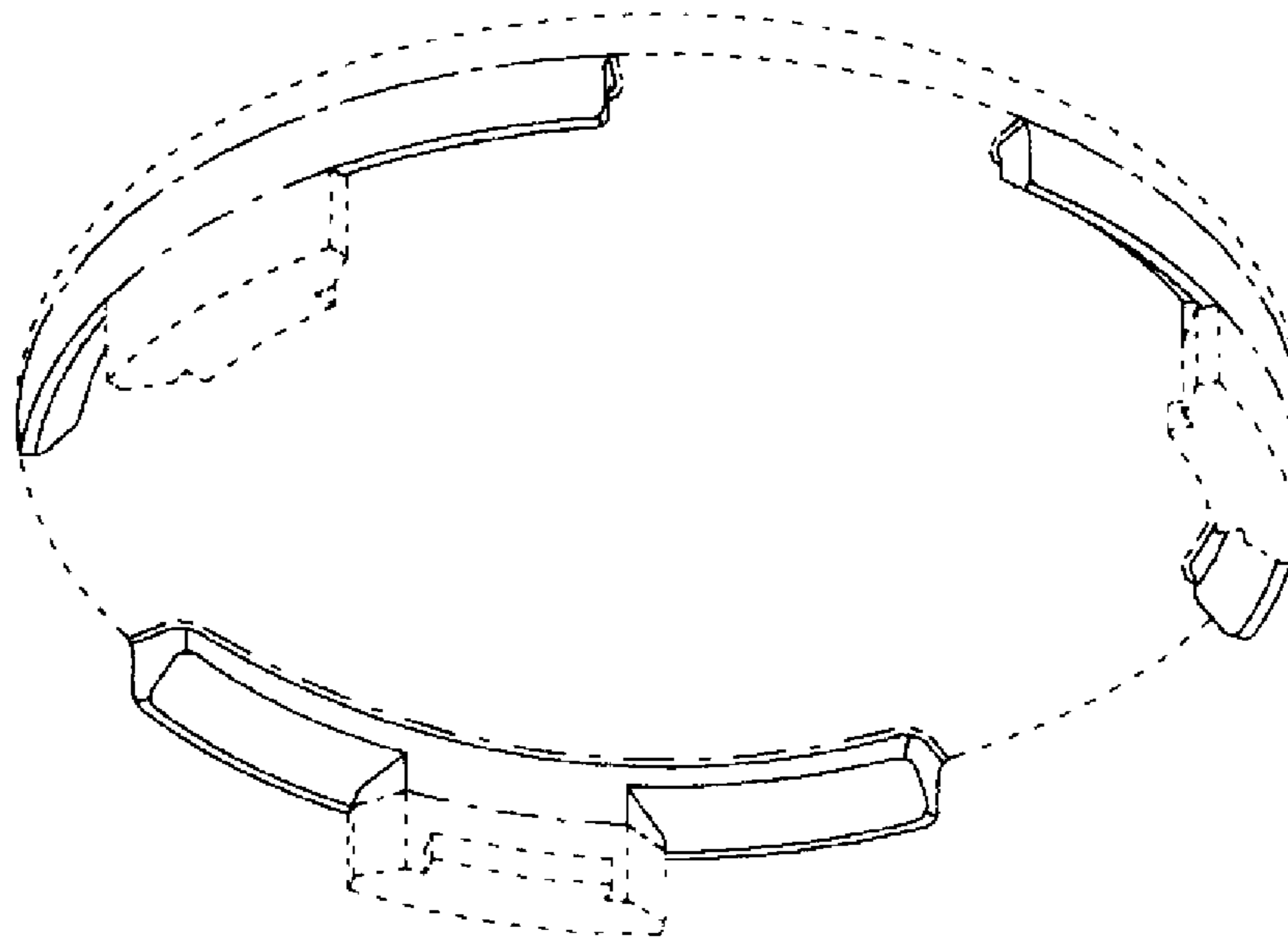

FIG.2