



US00D672826S

(12) **United States Design Patent**  
**Hornsby et al.**

(10) **Patent No.:** **US D672,826 S**  
(45) **Date of Patent:** **\*\* Dec. 18, 2012**

(54) **TOY ROBOTIC PET**

6,719,606 B1 4/2004 Mukensturm ..... 446/369  
D557,358 S \* 12/2007 Boutin ..... D21/592  
D637,668 S \* 5/2011 Welch ..... D21/597

(75) Inventors: **James Russell Hornsby**, Tampa, FL  
(US); **Joseph L. McGowan**, St. Charles,  
MO (US); **Dana L. Stewart**, St. Louis,  
MO (US)

**OTHER PUBLICATIONS**

Cale The Crab Wind-up Toy [www.toysrus.com/printProductPage/index.jsp?productId=3689429](http://www.toysrus.com/printProductPage/index.jsp?productId=3689429).

(73) Assignee: **Cepia, LLC**, St. Louis, MO (US)

\* cited by examiner

(\*\*) Term: **14 Years**

*Primary Examiner* — Sandra Morris

(21) Appl. No.: **29/405,903**

(74) *Attorney, Agent, or Firm* — Kevin Pumm

(22) Filed: **Nov. 8, 2011**

(57) **CLAIM**

(51) **LOC (9) Cl.** ..... **21-01**

The ornamental design for a toy robotic pet, as shown and described.

(52) **U.S. Cl.** ..... **D21/597**; D21/585

(58) **Field of Classification Search** ..... D11/158;

D21/576, 578, 584–585, 592, 597–603; D30/160;

446/72, 97, 268–269, 292–293, 369

See application file for complete search history.

**DESCRIPTION**

FIG. 1 is a perspective view of a toy robotic pet, showing my new design;

FIG. 2 is a front elevation view thereof;

FIG. 3 is a back elevation view thereof;

FIG. 4 is a right side elevation view thereof;

FIG. 5 is a left side elevation view thereof; and,

FIG. 6 is a top plan view thereof.

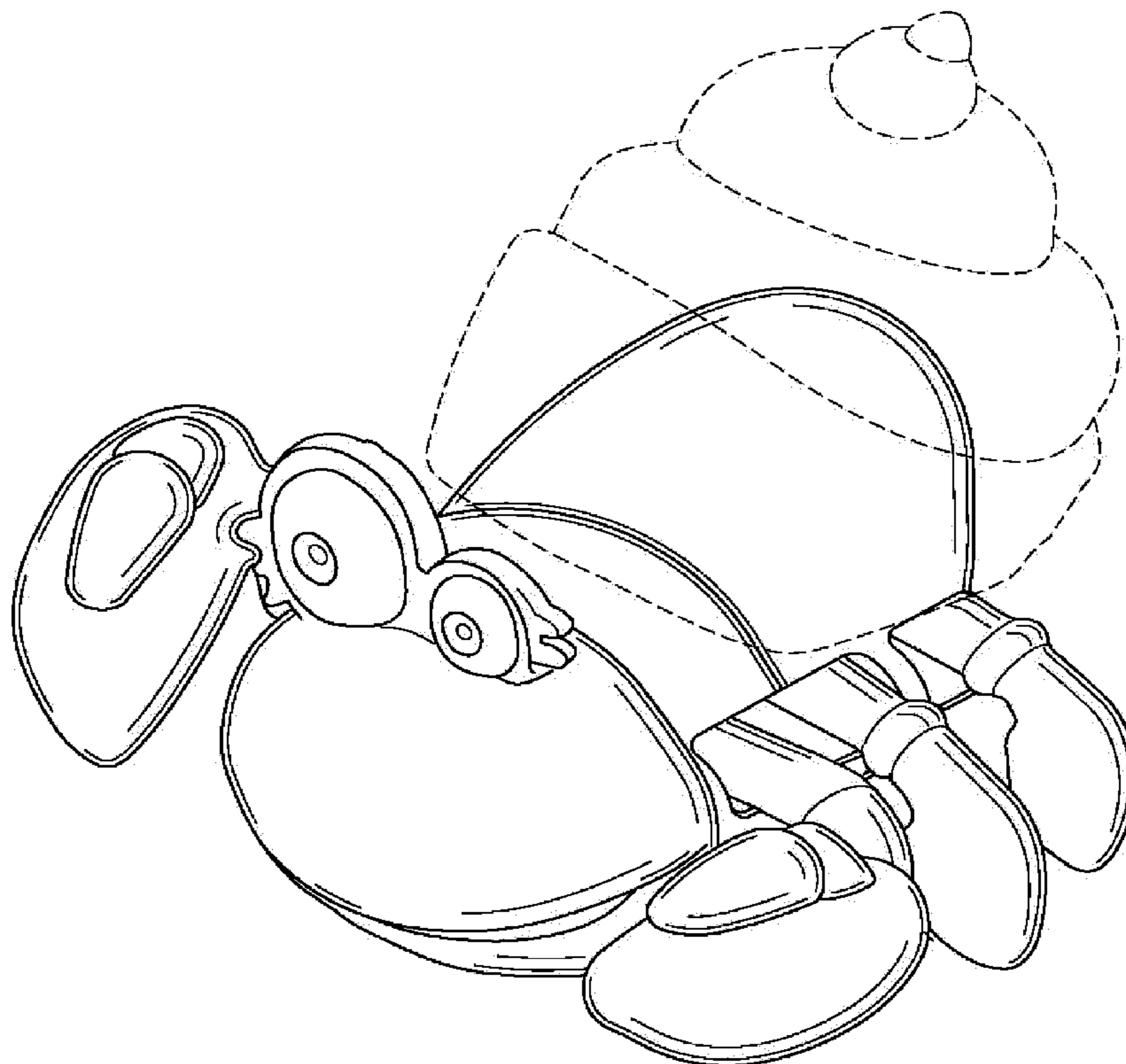
The details shown in broken lines are for illustrative purposes only and form no part of the claimed design.

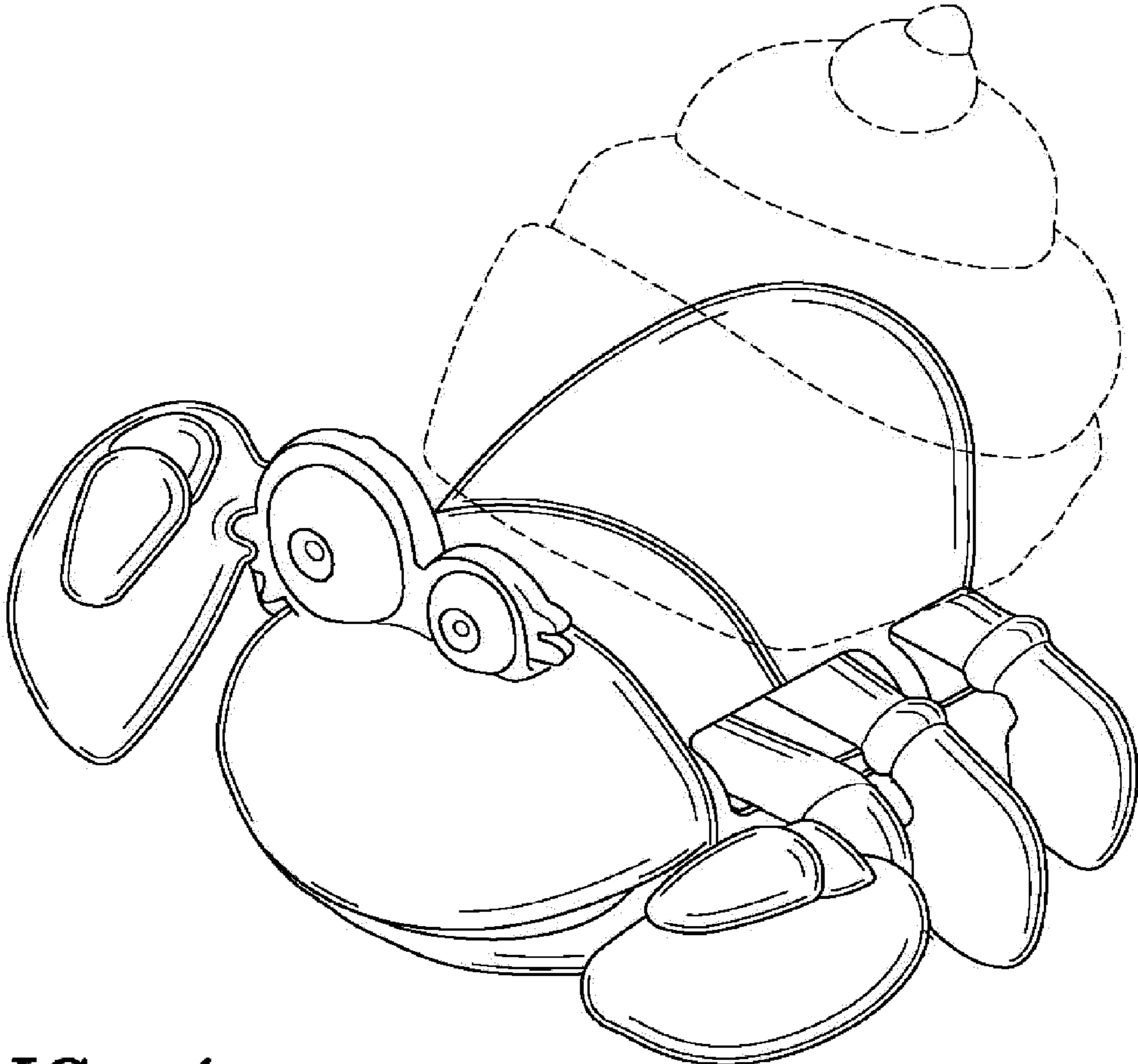
(56) **References Cited**

**U.S. PATENT DOCUMENTS**

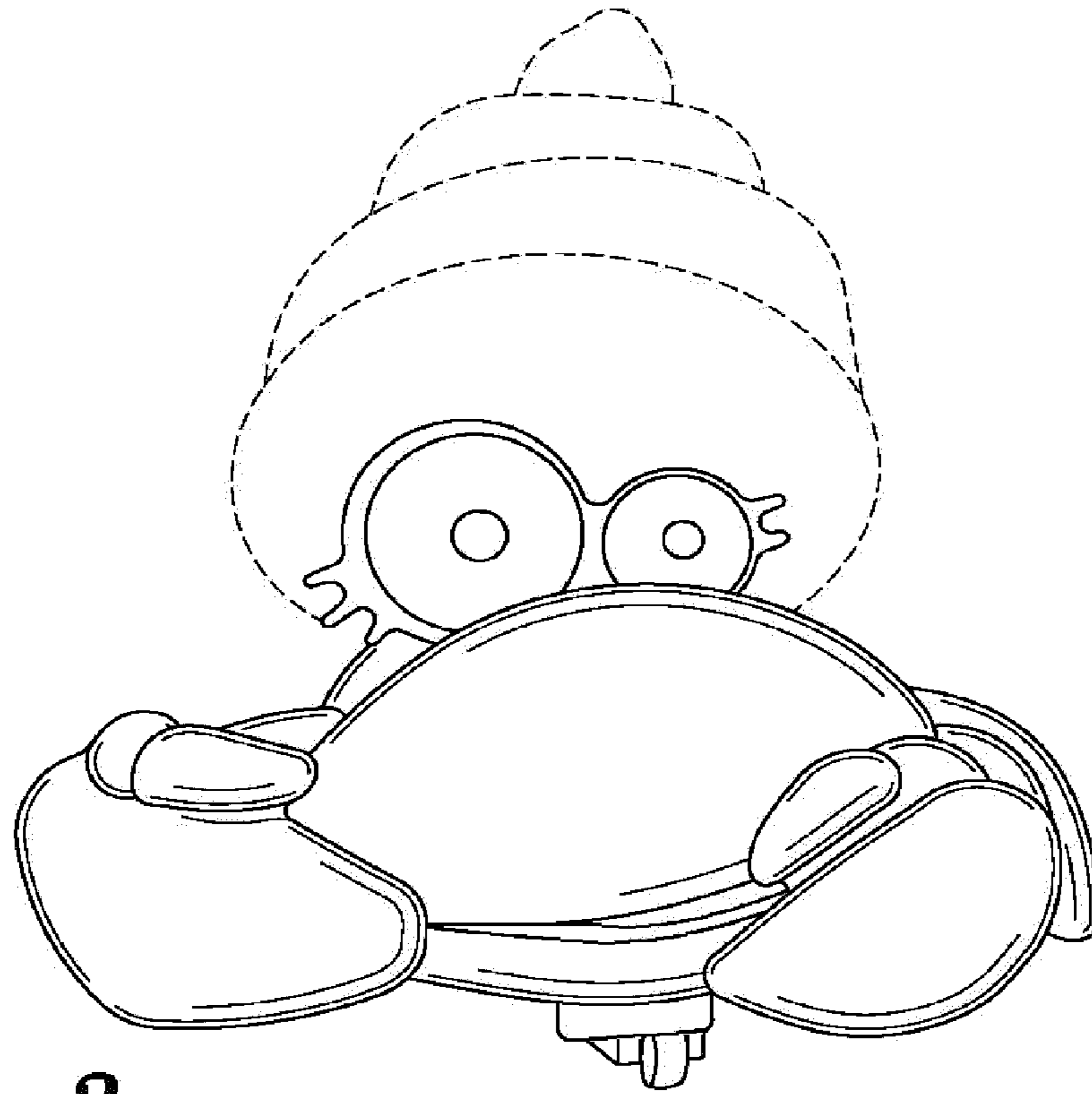
D66,246 S	5/1923	Puico	
D287,385 S	12/1986	Sato	D21/157
D446,829 S	8/2001	Choh	D21/578
D469,827 S	2/2003	Hornsby	D21/578
D483,773 S	* 12/2003	Lovegreen et al.	D21/597

**1 Claim, 4 Drawing Sheets**

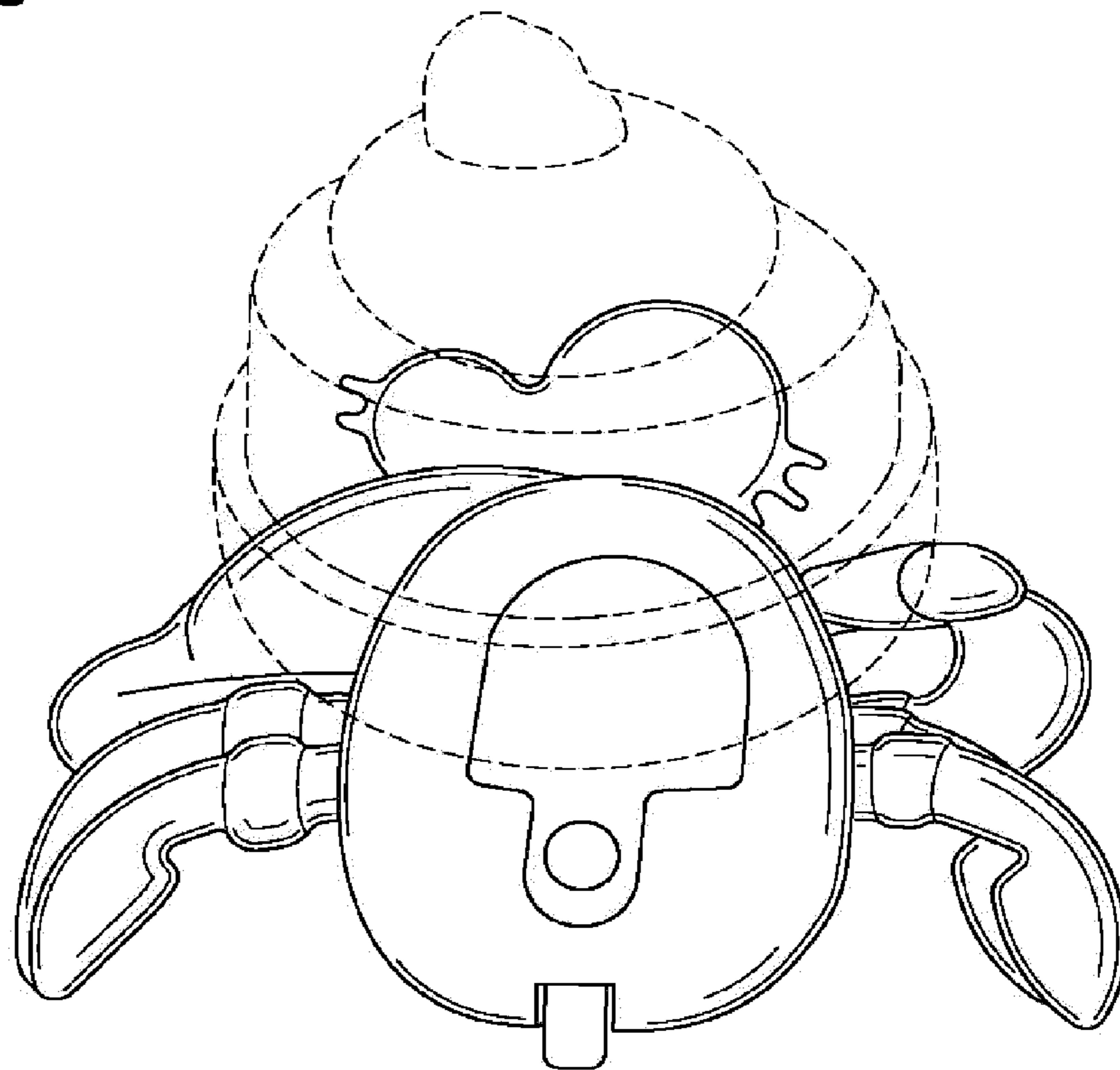




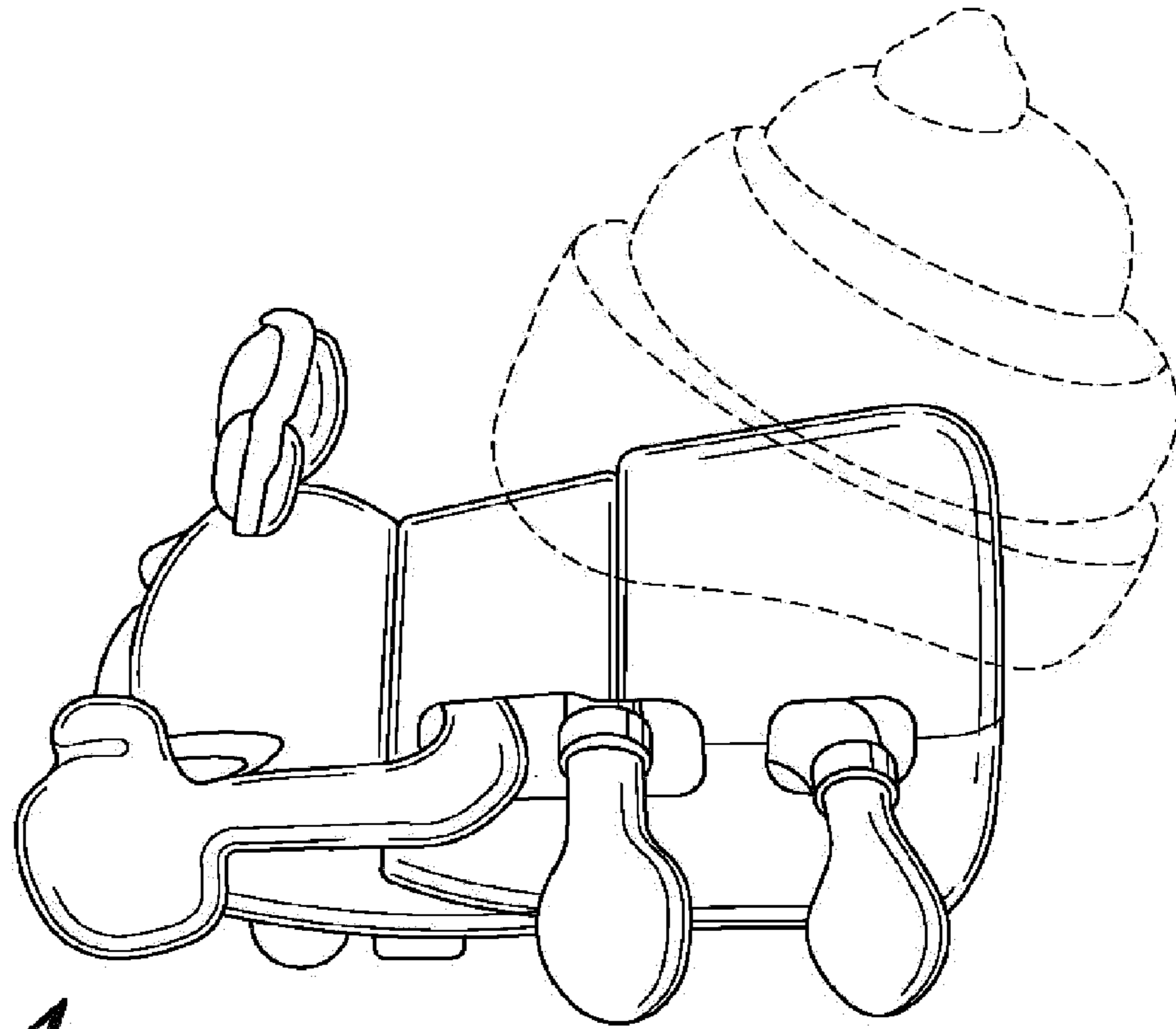
**FIG. 1**



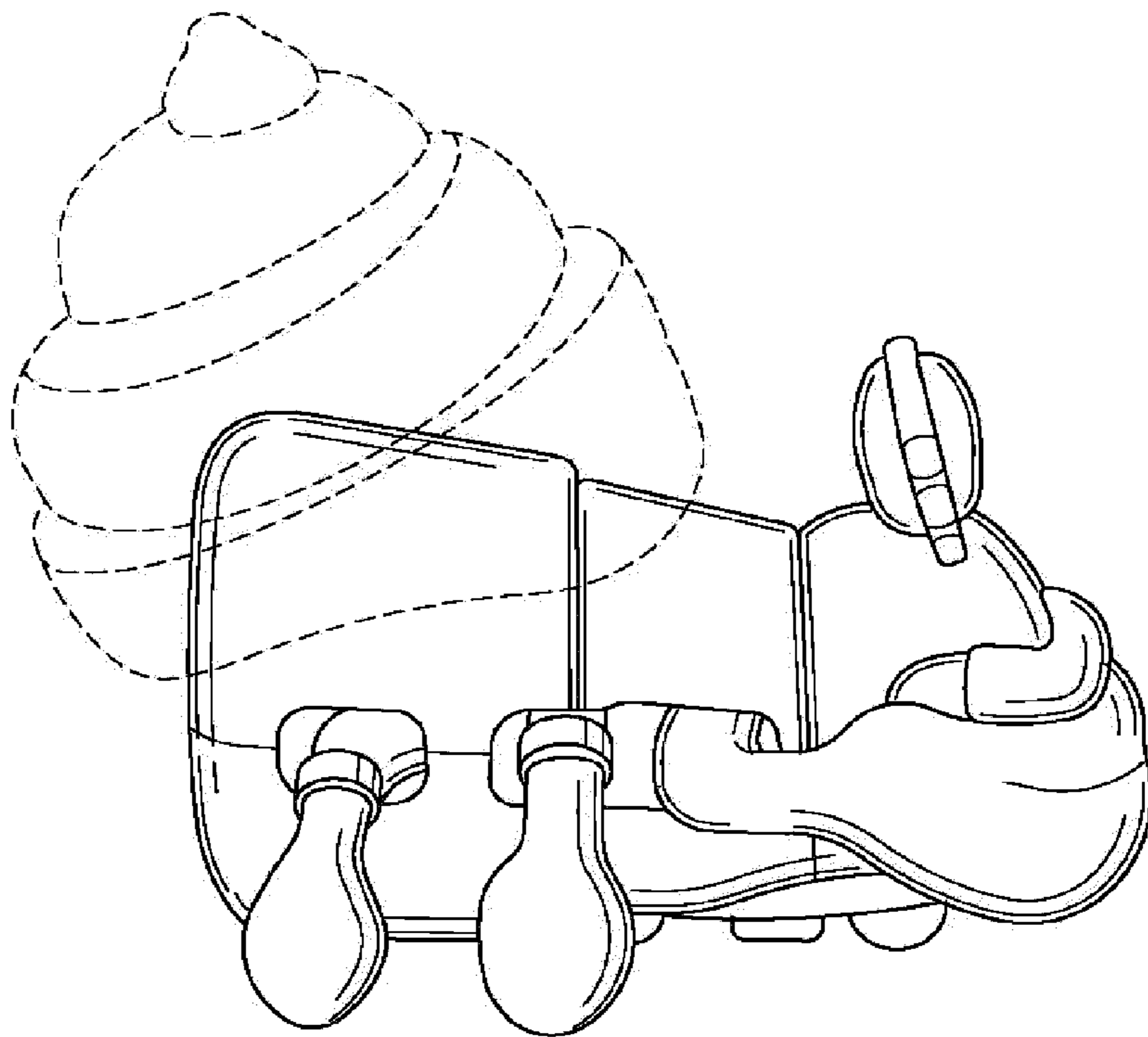
**FIG. 2**



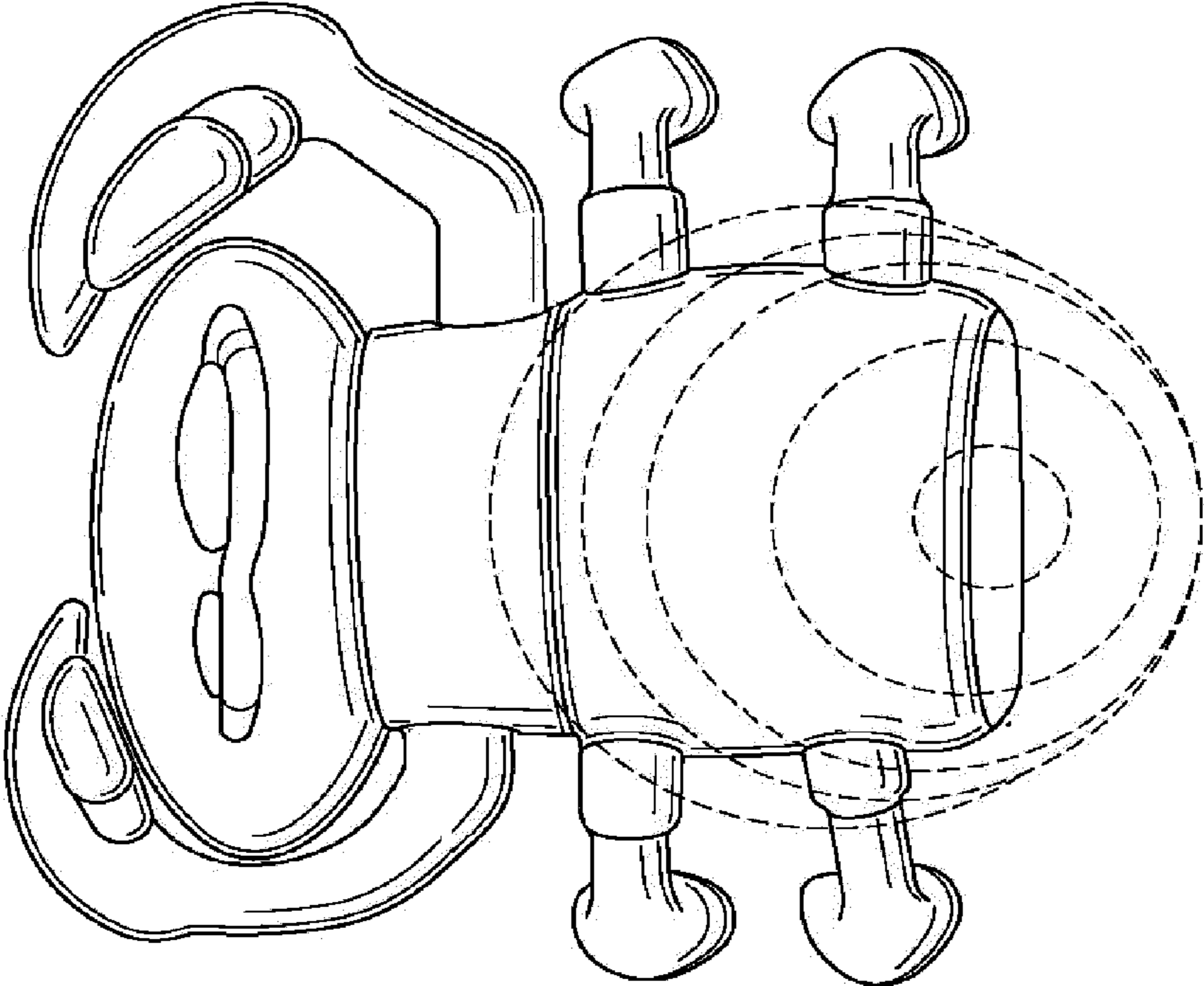
**FIG. 3**



**FIG. 4**



**FIG. 5**



**FIG. 6**