



US00D672813S

(12) **United States Design Patent**
Zhang

(10) **Patent No.:** **US D672,813 S**
(45) **Date of Patent:** **** Dec. 18, 2012**

(54) **PEN**
(75) Inventor: **Youbin Zhang**, Ningbo (CN)
(73) Assignee: **Beifa Group Co., Ltd.**, Ningbo (CN)
(**) Term: **14 Years**

D641,408 S * 7/2011 Zhang D19/50
D648,791 S * 11/2011 Li D19/50
D651,244 S 12/2011 Yuan
D651,245 S * 12/2011 Yuan D19/50
D653,705 S * 2/2012 Pearson D19/50
D656,193 S * 3/2012 Yuan D19/50
D664,197 S * 7/2012 Casciotti et al. D19/54
D665,025 S * 8/2012 Li et al. D19/50

(21) Appl. No.: **29/403,838**
(22) Filed: **Oct. 11, 2011**

OTHER PUBLICATIONS

Zhang, Y., "Pen," U.S. Appl. No. 29/403,836, filed Oct. 11, 2011.

(30) **Foreign Application Priority Data**
Apr. 18, 2011 (CN) 2011 3 0079339
(51) **LOC (9) Cl.** **19-06**
(52) **U.S. Cl.** **D19/50**
(58) **Field of Classification Search** D14/411;
D19/35, 36, 41-51, 54-58; 24/11 F, 11 P,
24/11 R; 401/52, 99-109, 192, 195, 196
See application file for complete search history.

* cited by examiner

Primary Examiner — Elizabeth Albert
(74) *Attorney, Agent, or Firm* — Christensen O'Connor
Johnson Kindness PLLC

(56) **References Cited**
U.S. PATENT DOCUMENTS
D497,643 S * 10/2004 Nishida D19/51
D534,958 S * 1/2007 Nishida D19/51
D540,866 S * 4/2007 Qiu D19/48
D559,909 S 1/2008 Qiu
D561,254 S 2/2008 Lin
D565,102 S * 3/2008 Anand D19/50
D580,978 S 11/2008 Miller
D583,864 S 12/2008 Liu
D601,197 S * 9/2009 Zhang D19/48
D628,643 S * 12/2010 Li D19/50
D641,407 S * 7/2011 Li D19/50

(57) **CLAIM**
The ornamental design for a pen, as shown and described.

DESCRIPTION

FIG. 1 is a front right perspective view of a pen showing my new design;
FIG. 2 is a front elevation view thereof;
FIG. 3 is a rear elevation view thereof;
FIG. 4 is a right side elevation view thereof, with the left side elevation view being a mirror image of the right side elevation view;
FIG. 5 is an enlarged top plan view thereof; and,
FIG. 6 is an enlarged bottom plan view thereof.

1 Claim, 4 Drawing Sheets

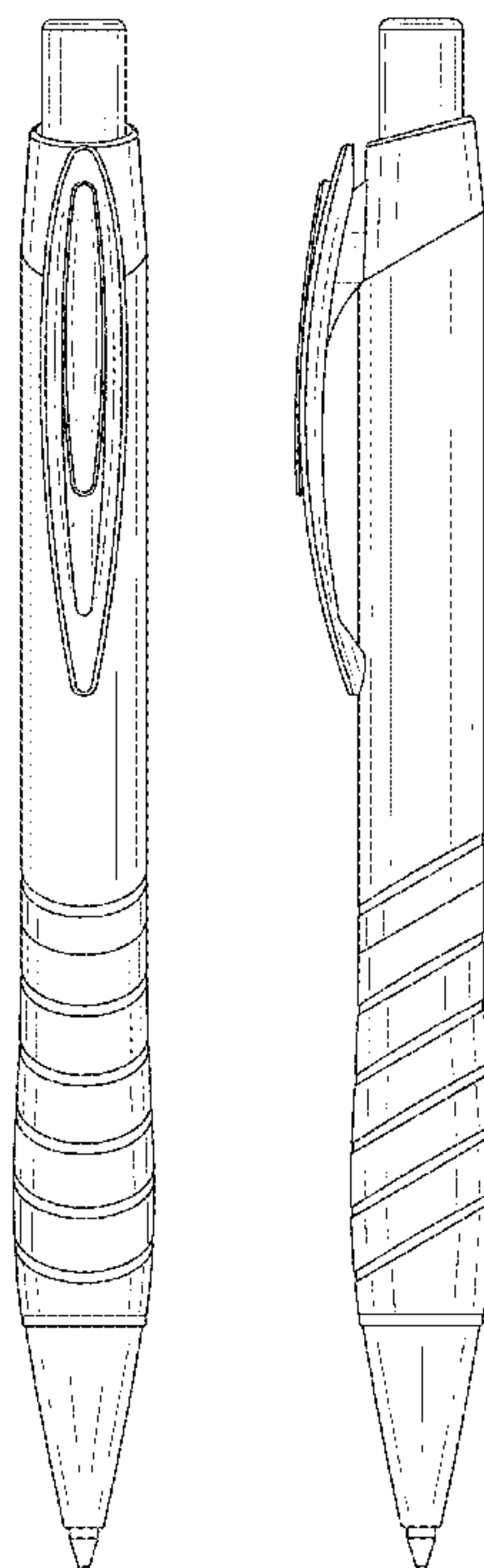

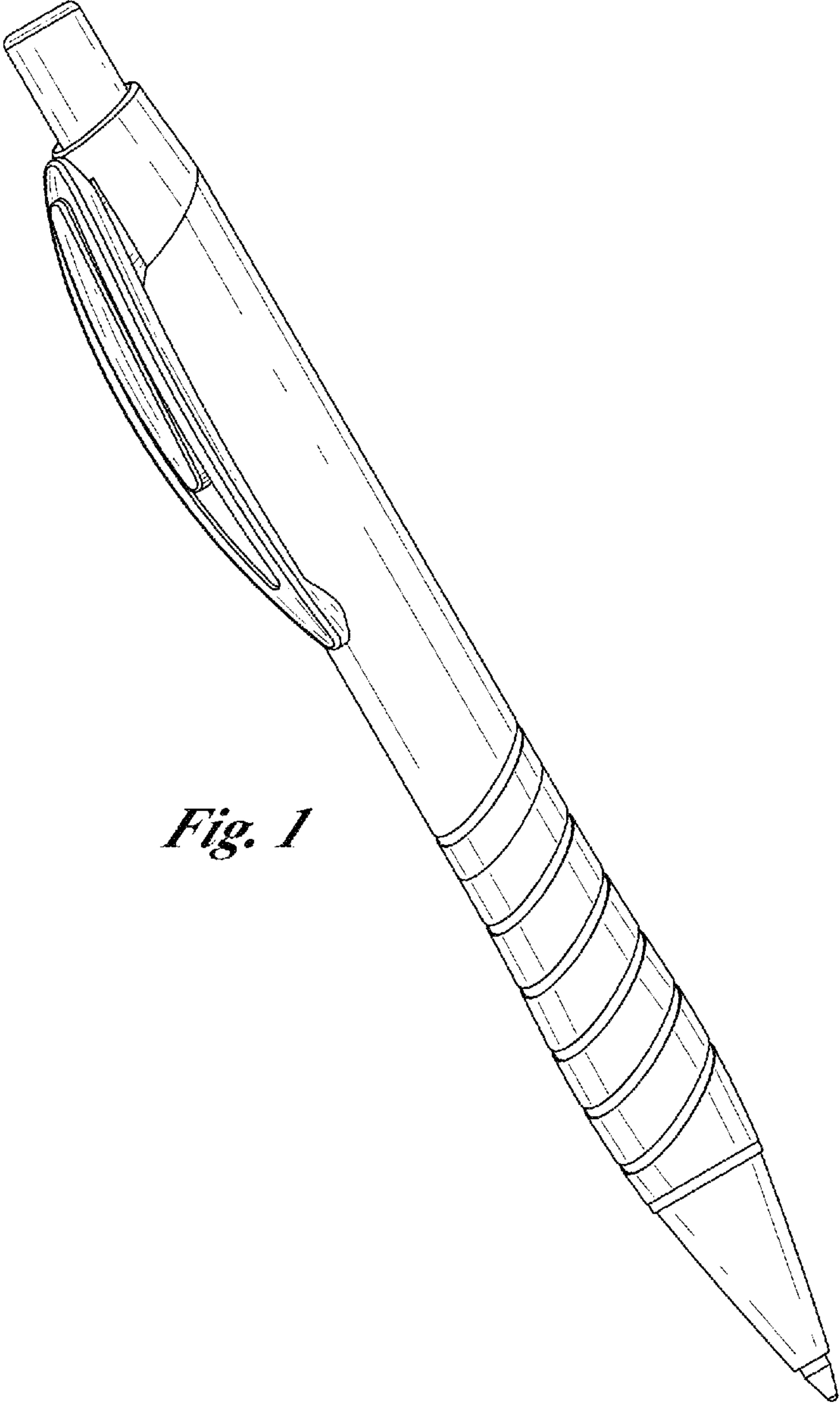

Fig. 1

Fig. 2

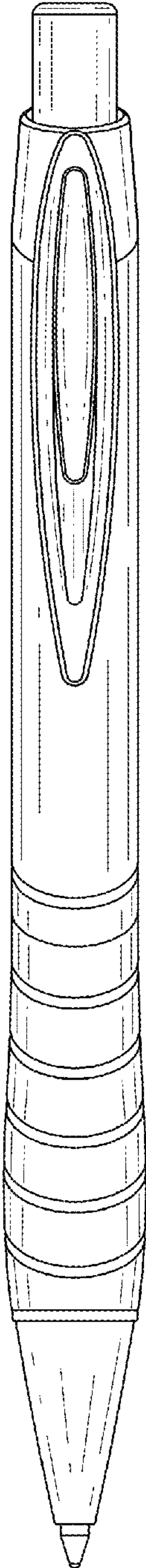
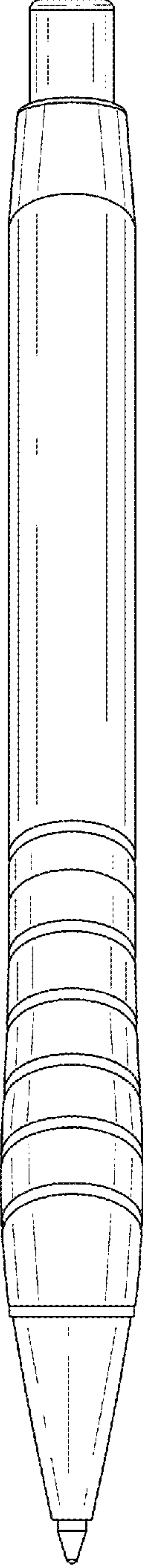

Fig. 3



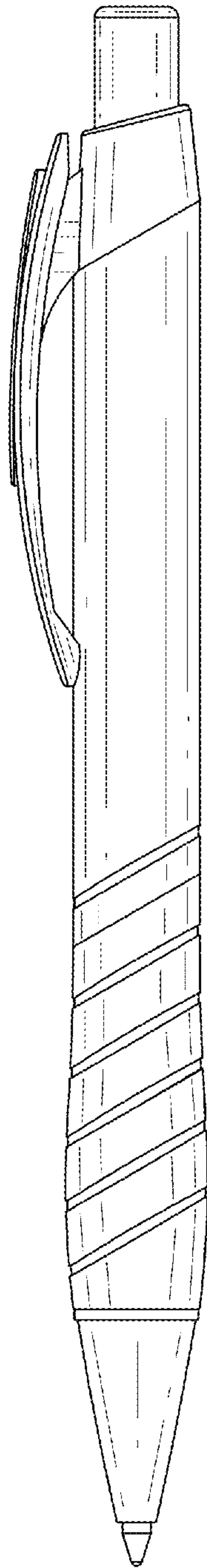

Fig. 4

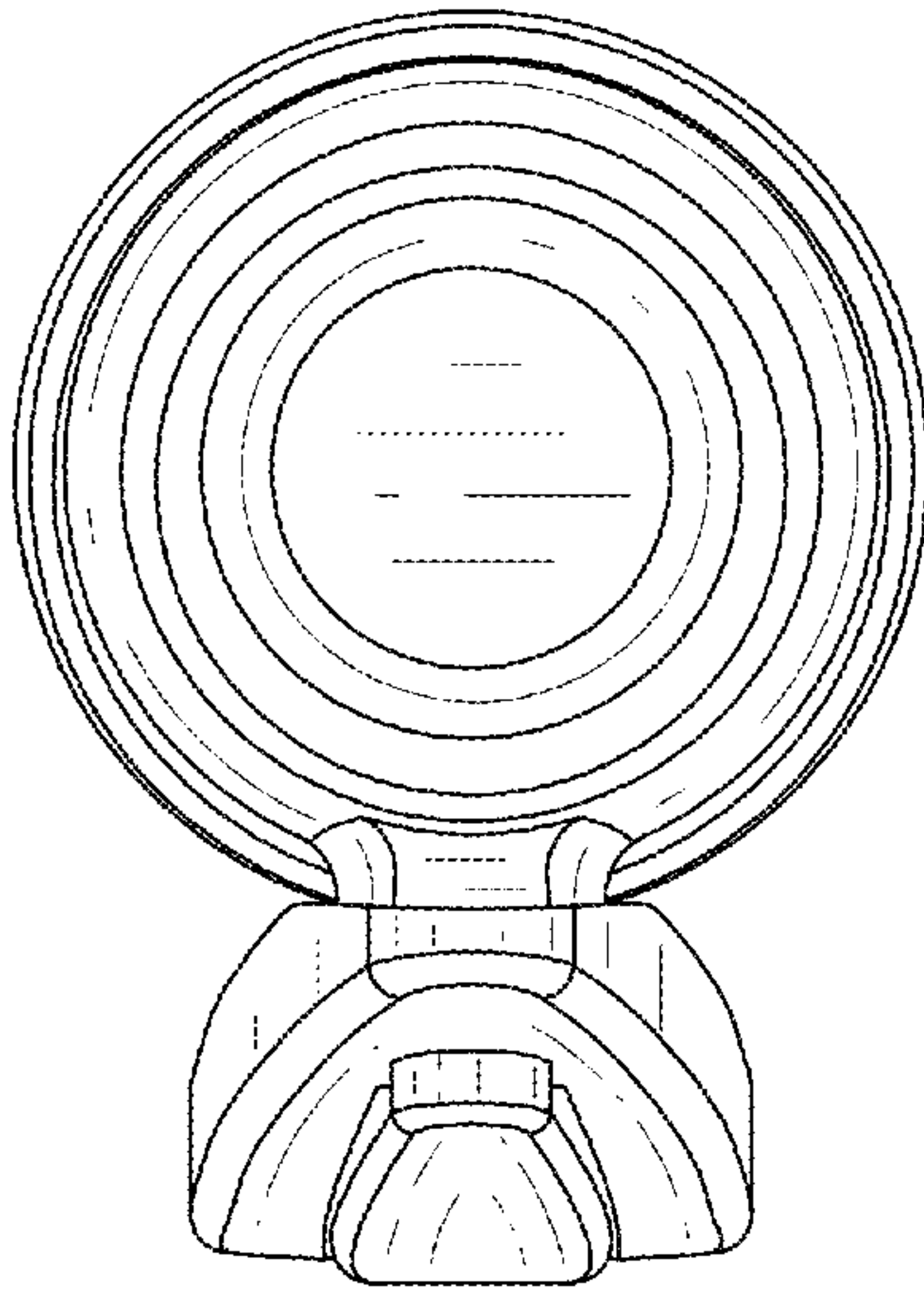

Fig. 5

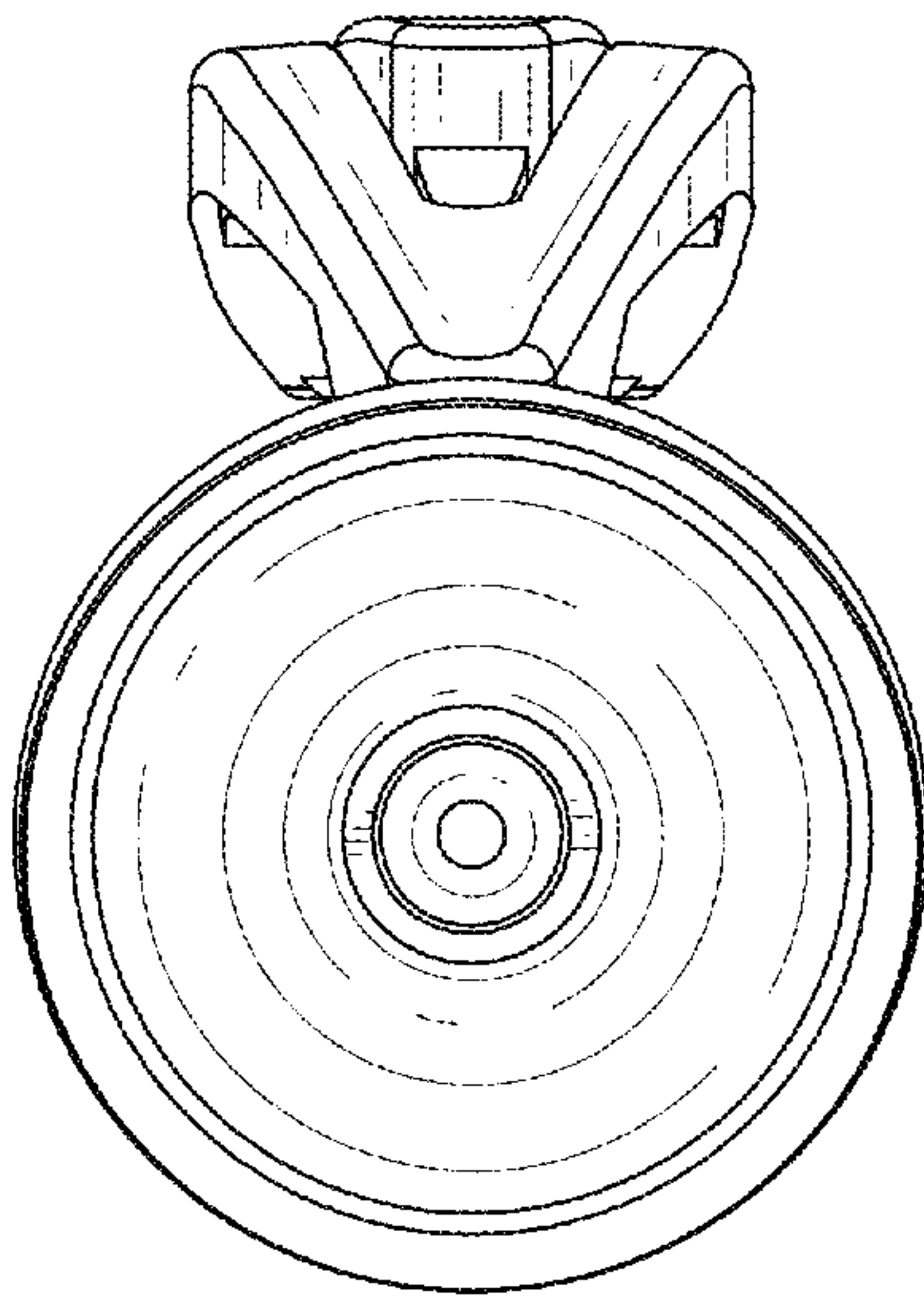

Fig. 6