



US00D672807S

(12) **United States Design Patent**
Ahrabian

(10) **Patent No.:** **US D672,807 S**

(45) **Date of Patent:** **** Dec. 18, 2012**

(54) **METAL TRANSACTION CARD**

(76) Inventor: **Darius Ahrabian**, Gruenwald (DE)

(**) Term: **14 Years**

(21) Appl. No.: **29/366,588**

(22) Filed: **Jul. 27, 2010**

(51) **LOC (9) Cl.** **19-08**

(52) **U.S. Cl.** **D19/9**

(58) **Field of Classification Search** D19/1-12,
D19/20-34, 100; 40/124.01-124.15, 672,
40/661, 726, 617, 776; 283/72, 74, 103,
283/105-106; D6/407, 632; 235/380, 449,
235/484, 492, 493, 488; D20/10, 22, 17,
D20/27, 40, 11; D14/435-437, 478

See application file for complete search history.

(56) **References Cited**

U.S. PATENT DOCUMENTS

D436,620 S *	1/2001	Webb et al.	D19/9
D436,991 S	1/2001	Morgante		
D442,628 S	5/2001	Webb et al.		
D457,556 S	5/2002	Hochschild		
D468,313 S	1/2003	Burke		
D478,622 S	8/2003	Grayson		
D481,068 S *	10/2003	Blossom et al.	D19/10
D493,195 S	7/2004	Creighton		
D499,101 S	11/2004	Hart et al.		
D505,450 S	5/2005	Lauer et al.		
D514,619 S	2/2006	Brink et al.		
D516,563 S	3/2006	Hart et al.		
D522,052 S	5/2006	Lubking		
D523,472 S	6/2006	Brink et al.		
D554,643 S	11/2007	McCarty et al.		
D559,905 S	1/2008	Halbur et al.		
D560,715 S	1/2008	Hogg		
D560,717 S	1/2008	Robertson		
D562,888 S	2/2008	Brown		
D565,097 S	3/2008	Brown		
D571,075 S	6/2008	Yalinkaya		
D573,182 S	7/2008	Ricketts et al.		
D578,159 S	10/2008	Hachey et al.		
D579,044 S	10/2008	Lasoh et al.		
7,530,491 B2	5/2009	Lasch et al.		
D597,307 S	8/2009	Yuendling		

7,588,184 B2	9/2009	Gandel et al.		
D602,986 S	10/2009	Skelding et al.		
D604,359 S	11/2009	Santos		
D615,585 S	5/2010	Skinner et al.		
D616,020 S	5/2010	Hoppus et al.		
D616,932 S	6/2010	Albers et al.		
D623,690 S *	9/2010	Skelding et al.	D19/10
D635,186 S *	3/2011	Skelding et al.	D19/9
D643,062 S *	8/2011	Skelding et al.	D19/9

* cited by examiner

Primary Examiner — Caron D Veynar

Assistant Examiner — Abraham Bahta

(74) *Attorney, Agent, or Firm* — MDIP LLC

(57) **CLAIM**

The ornamental design for a metal transaction card, as shown and described.

DESCRIPTION

FIG. 1 depicts a front elevation view of a metal transaction card.

FIG. 2 depicts a perspective view of the front of the metal transaction card of FIG. 1.

FIG. 3 depicts another perspective review of the front of the metal transaction card of FIG. 1.

FIG. 4 depicts a back elevation view of the metal transaction card of FIG. 1.

FIG. 5 depicts a top plan view of the metal transaction card of FIG. 1, the bottom plan view being the mirror image thereof.

FIG. 6 depicts a left elevation view of the metal transaction card of FIG. 1, the right elevation view being the mirror image thereof.

FIG. 7 depicts a front elevation view of another embodiment of a metal transaction card.

FIG. 8 depicts a perspective view of the front of the metal transaction card of FIG. 7.

FIG. 9 depicts another perspective review of the front of the metal transaction card of FIG. 7.

FIG. 10 depicts a back elevation view of the metal transaction card of FIG. 7.

FIG. 11 depicts a top plan view of the metal transaction card of FIG. 7, the bottom plan view being the mirror image thereof.

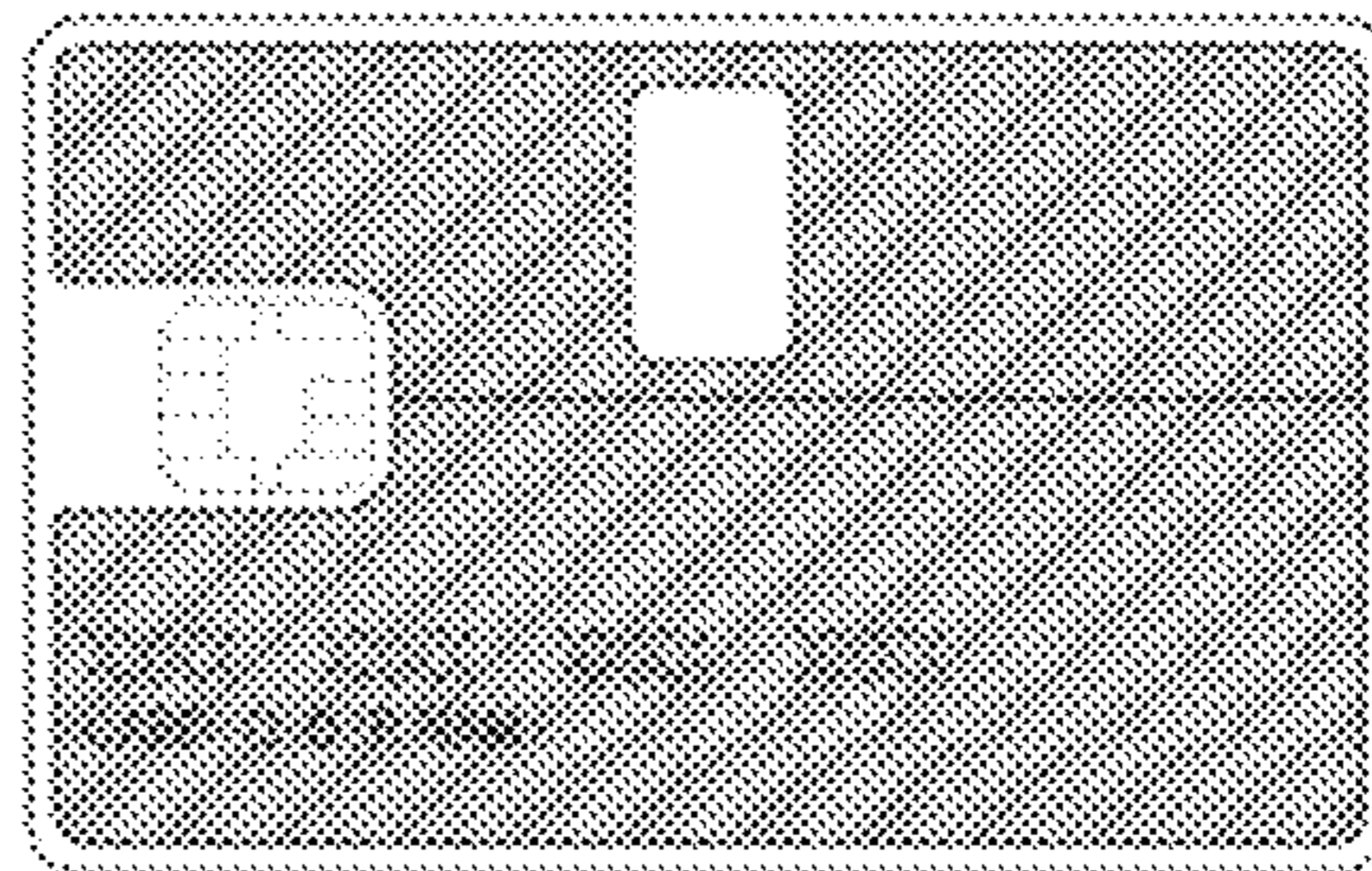
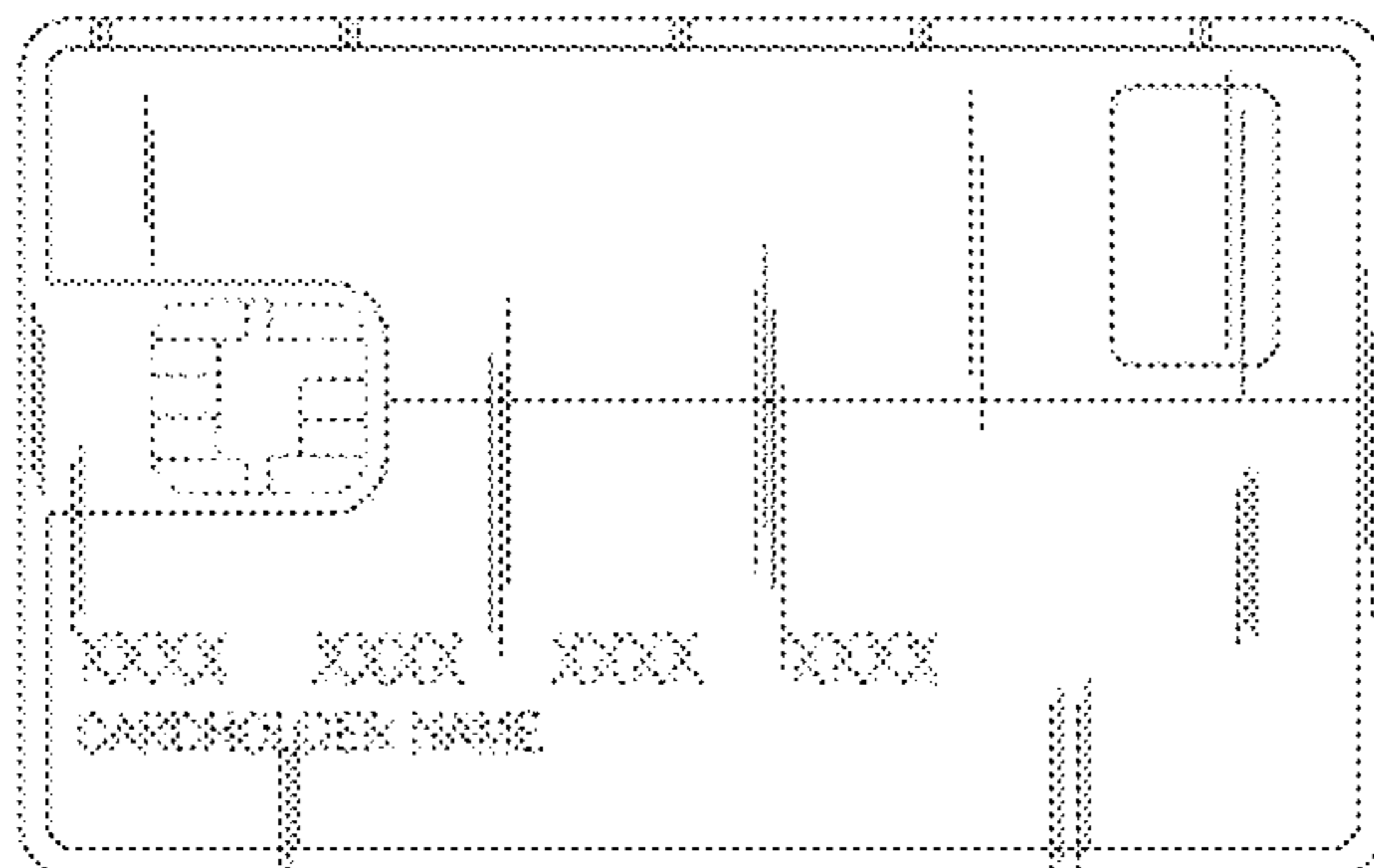

FIG. 12 depicts a left elevation view of the metal transaction card of FIG. 7, the right elevation view being the mirror image thereof.

FIG. 13 depicts a front elevation view of another embodiment of a metal transaction card.

FIG. 14 depicts a perspective view of the front of the metal transaction card of FIG. 13.

FIG. 15 depicts another perspective view of the front of the metal transaction card of FIG. 13.

FIG. 16 depicts a back elevation view of the metal transaction card of FIG. 13.

FIG. 17 depicts a top plan view of the metal transaction card of FIG. 13, the bottom plan view being the mirror image thereof.

FIG. 18 depicts a left elevation view of the metal transaction card of FIG. 13, the right elevation view being the mirror image thereof.

FIG. 19 depicts a front elevation view of another embodiment of a metal transaction card, the metal transaction card having a wood inlay as shown.

FIG. 20 depicts a perspective view of the front of the metal transaction card of FIG. 19.

FIG. 21 depicts another perspective view of the front of the metal transaction card of FIG. 19.

FIG. 22 depicts a back elevation view of the metal transaction card of FIG. 19.

FIG. 23 depicts a top plan view of the metal transaction card of FIG. 19, the bottom plan view being the mirror image thereof.

FIG. 24 depicts a left elevation view of the metal transaction card of FIG. 19, the right elevation view being the mirror image thereof.

FIG. 25 depicts a front elevation view of another embodiment of a metal transaction card, the metal transaction card having a wood inlay as shown.

FIG. 26 depicts a perspective view of the front of the metal transaction card of FIG. 25.

FIG. 27 depicts another perspective view of the front of the metal transaction card of FIG. 25.

FIG. 28 depicts a back elevation view of the metal transaction card of FIG. 25.

FIG. 29 depicts a top plan view of the metal transaction card of FIG. 25, the bottom plan view being the mirror image thereof.

FIG. 30 depicts a left elevation view of the metal transaction card of FIG. 25, the right elevation view being the mirror image thereof.

FIG. 31 depicts a front elevation view of another embodiment of a metal transaction card, the metal transaction card having a wood inlay as shown.

FIG. 32 depicts a perspective view of the front of the metal transaction card of FIG. 31.

FIG. 33 depicts another perspective view of the front of the metal transaction card of FIG. 31.

FIG. 34 depicts a back elevation view of the metal transaction card of FIG. 31.

FIG. 35 depicts a top plan view of the metal transaction card of FIG. 31, the bottom plan view being the mirror image thereof.

FIG. 36 depicts a left elevation view of the metal transaction card of FIG. 31, the right elevation view being the mirror image thereof.

FIG. 37 depicts a front elevation view of another embodiment of a metal transaction card, the metal transaction card having a leather inlay as shown.

FIG. 38 depicts a perspective view of the front of the metal transaction card of FIG. 37.

FIG. 39 depicts another perspective view of the front of the metal transaction card of FIG. 37.

FIG. 40 depicts a back elevation view of the metal transaction card of FIG. 37.

FIG. 41 depicts a top plan view of the metal transaction card of FIG. 37, the bottom plan view being the mirror image thereof.

FIG. 42 depicts a left elevation view of the metal transaction card of FIG. 37, the right elevation view being the mirror image thereof.

FIG. 43 depicts a front elevation view of another embodiment of a metal transaction card, the metal transaction card having a leather inlay as shown.

FIG. 44 depicts a perspective view of the front of the metal transaction card of FIG. 43.

FIG. 45 depicts another perspective view of the front of the metal transaction card of FIG. 43.

FIG. 46 depicts a back elevation view of the metal transaction card of FIG. 43.

FIG. 47 depicts a top plan view of the metal transaction card of FIG. 43, the bottom plan view being the mirror image thereof.

FIG. 48 depicts a left elevation view of the metal transaction card of FIG. 43, the right elevation view being the mirror image thereof.

FIG. 49 depicts a front elevation view of another embodiment of a metal transaction card, the metal transaction card having a leather inlay as shown.

FIG. 50 depicts a perspective view of the front of the metal transaction card of FIG. 49.

FIG. 51 depicts another perspective view of the front of the metal transaction card of FIG. 49.

FIG. 52 depicts a back elevation view of the metal transaction card of FIG. 49.

FIG. 53 depicts a top plan view of the metal transaction card of FIG. 49, the bottom plan view being the mirror image thereof; and,

FIG. 54 depicts a left elevation view of the metal transaction card of FIG. 49, the right elevation view being the mirror image thereof.

The broken lines in the drawings illustrate environmental structure on the article and form no part of the claimed design.

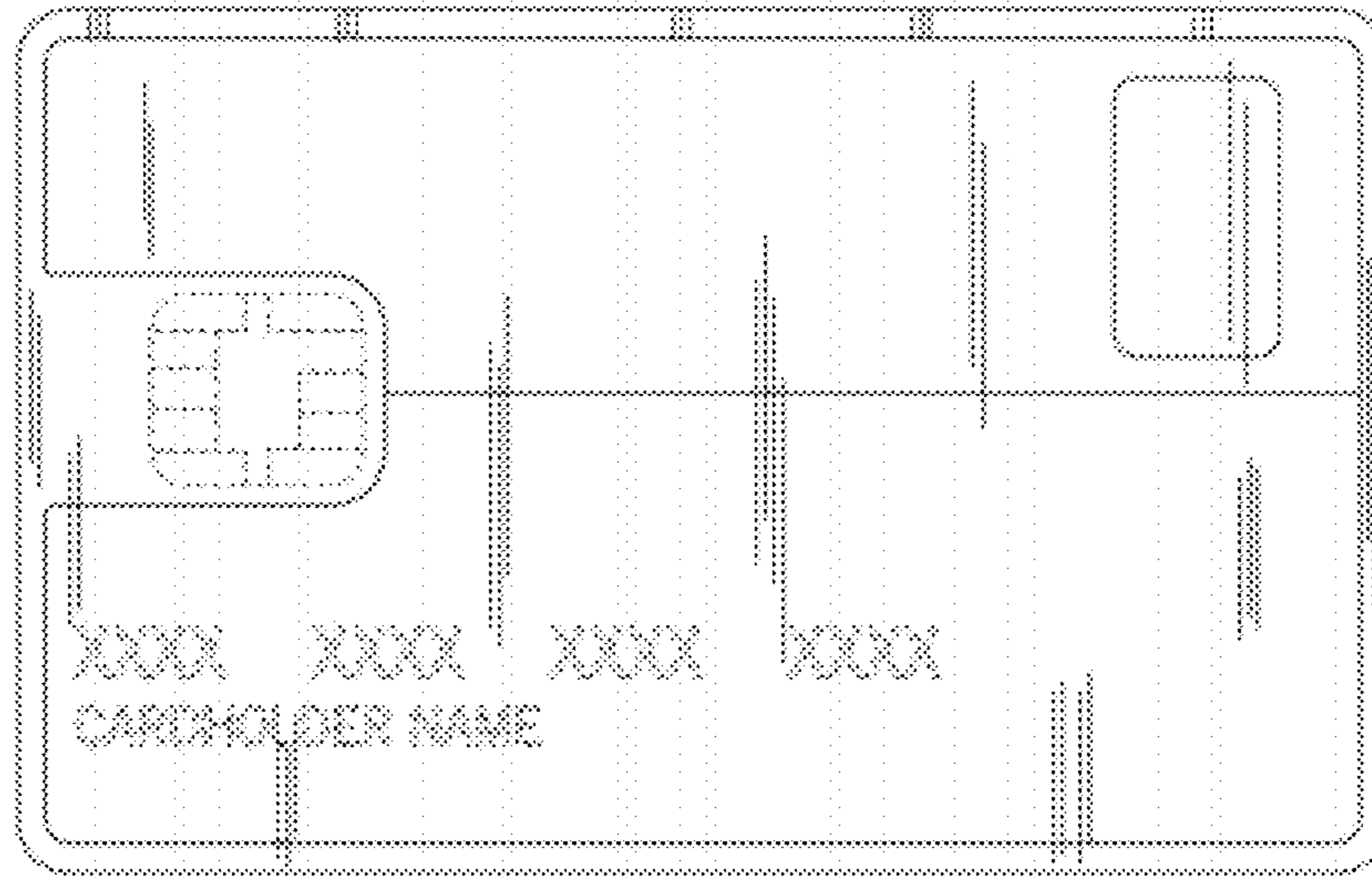

FIG. 1

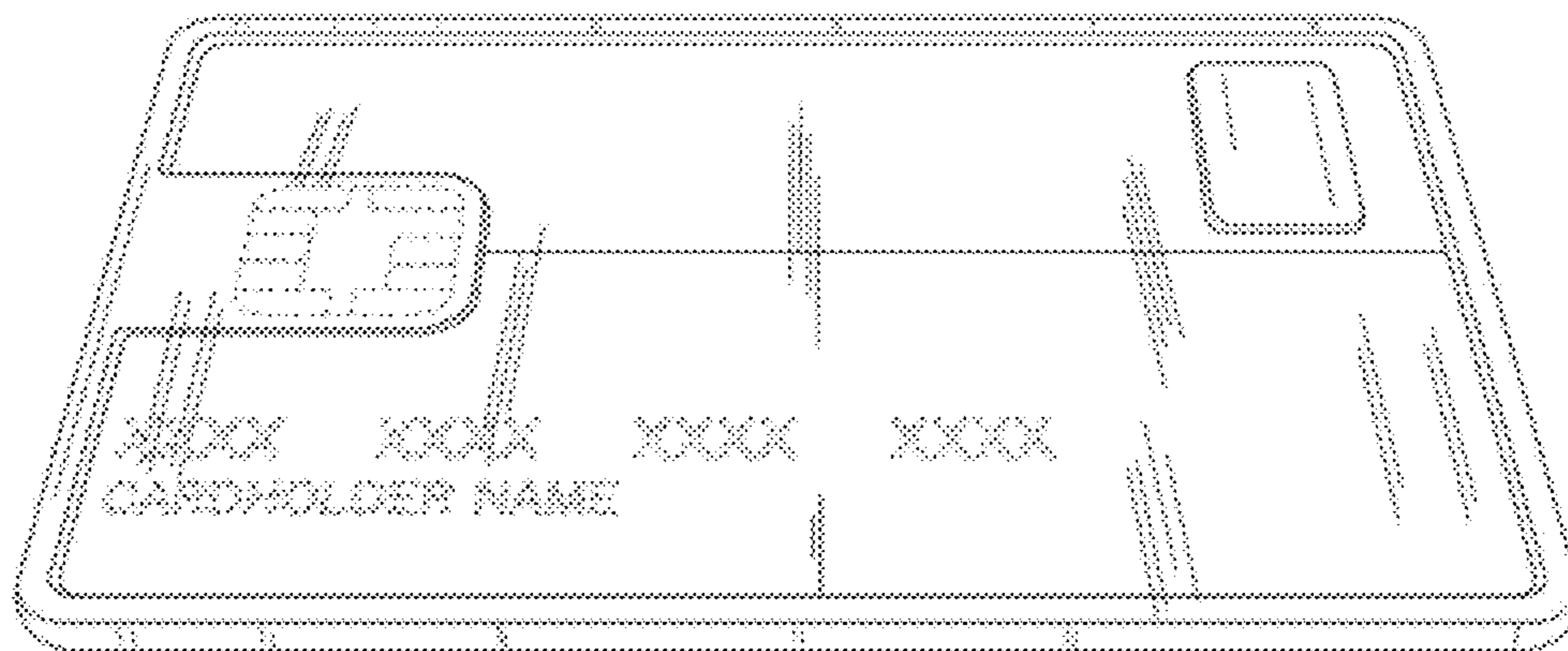

FIG. 2

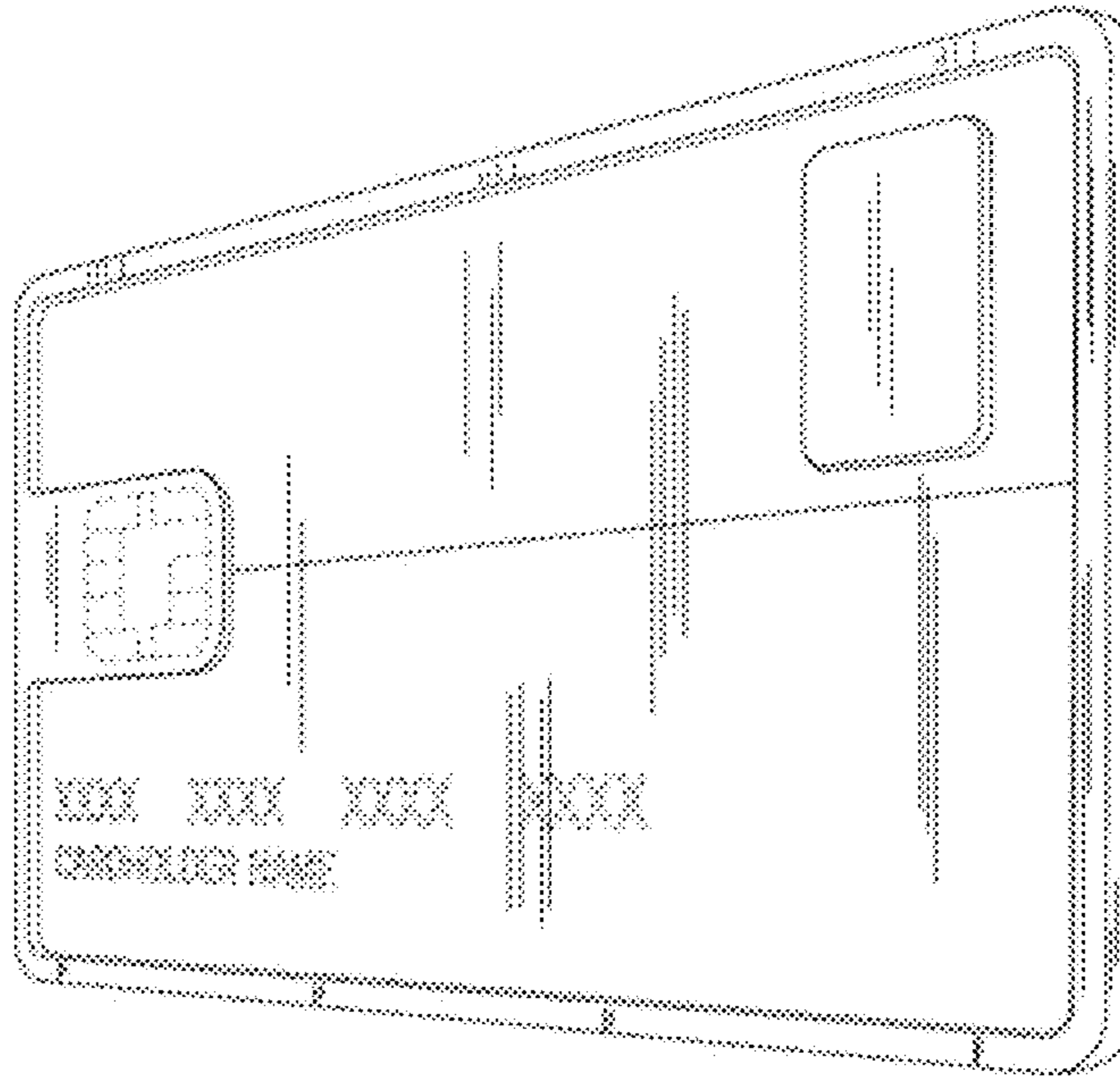

FIG. 3

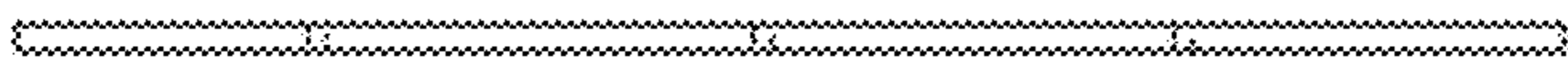

FIG. 5

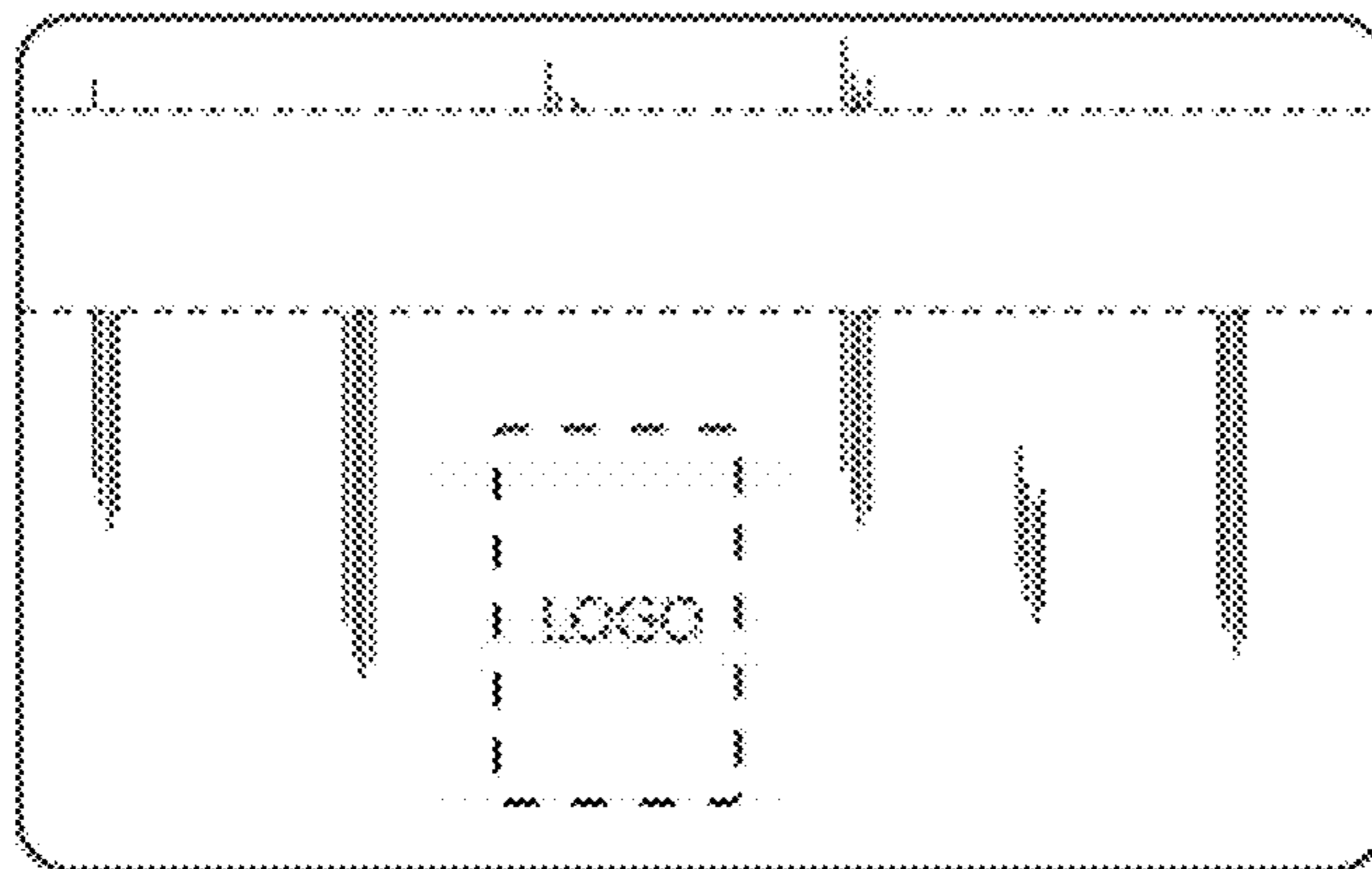

FIG. 4



FIG. 6

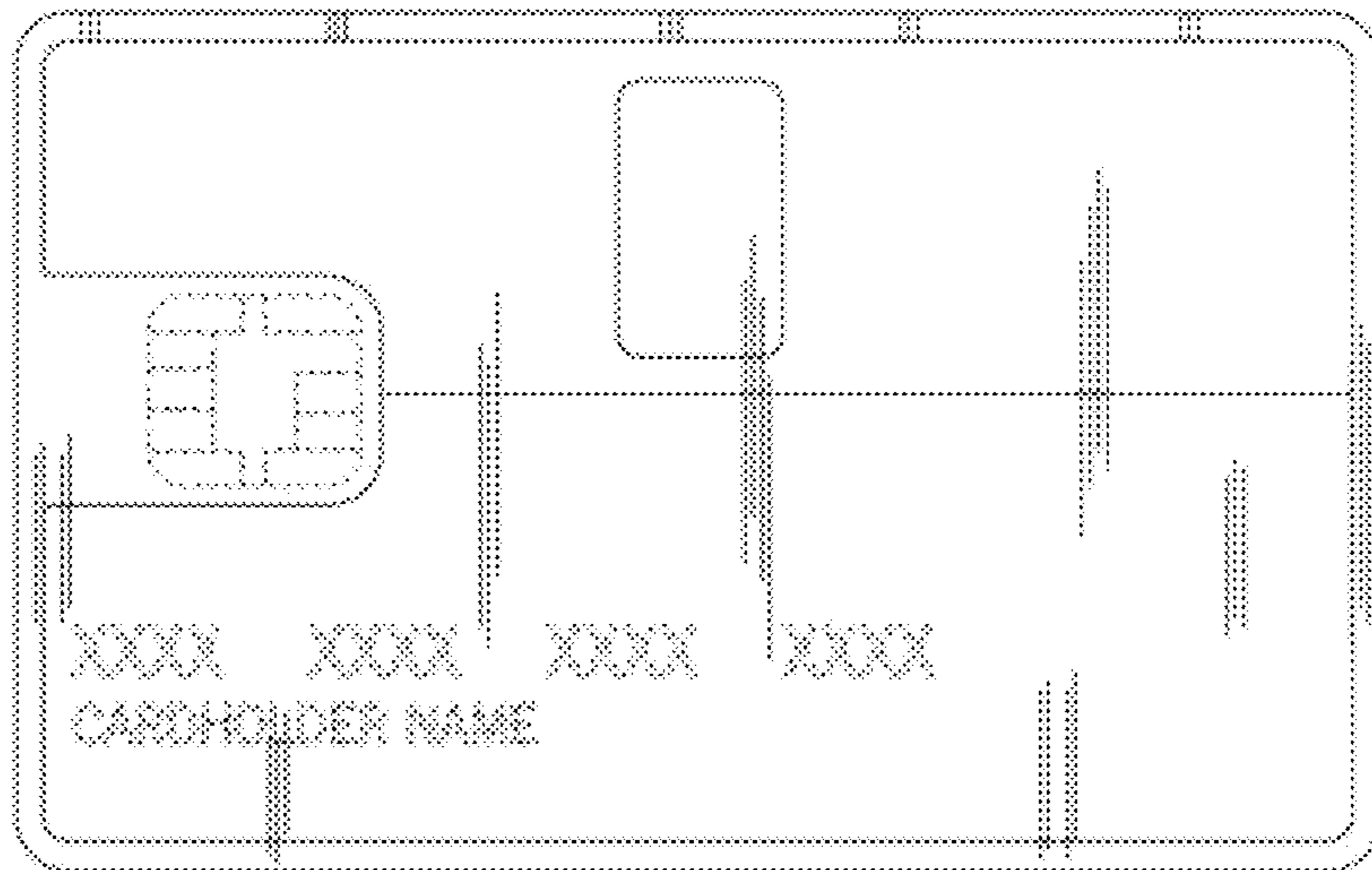

FIG. 7

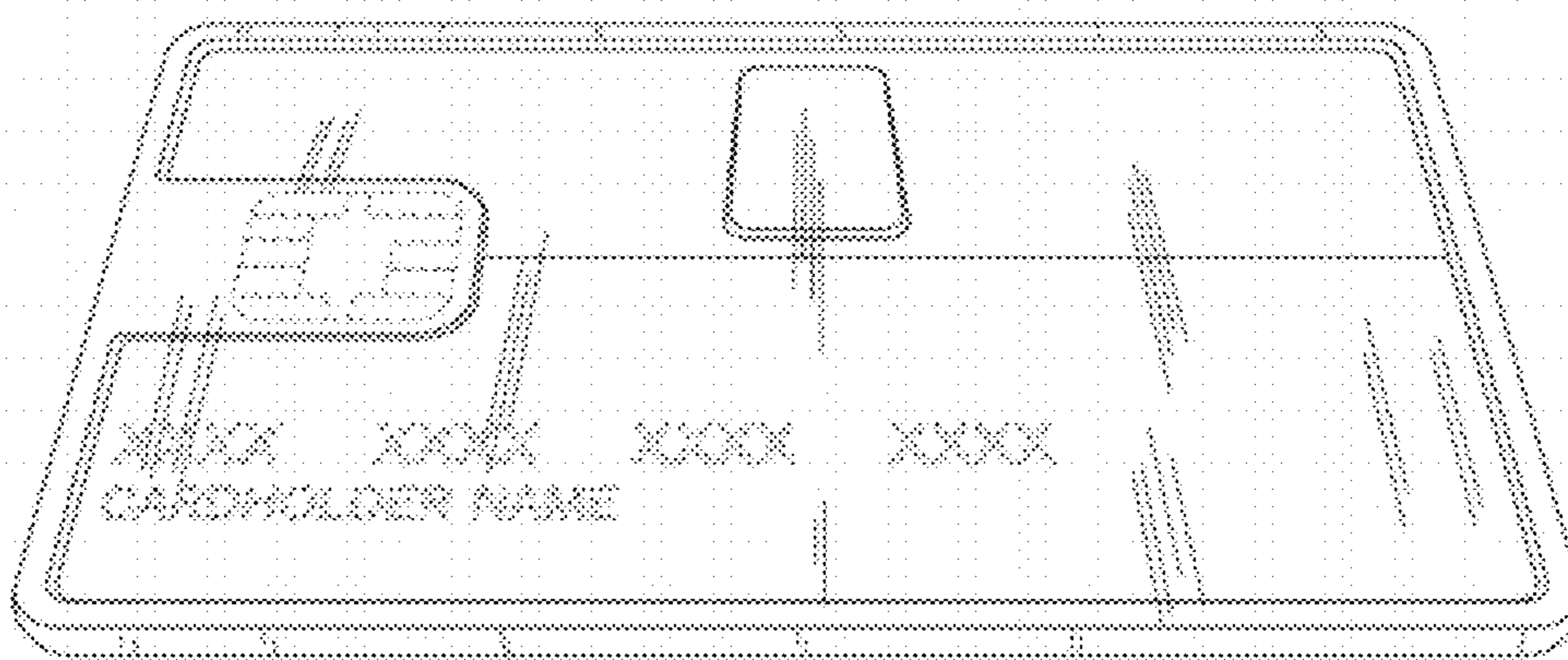

FIG. 8

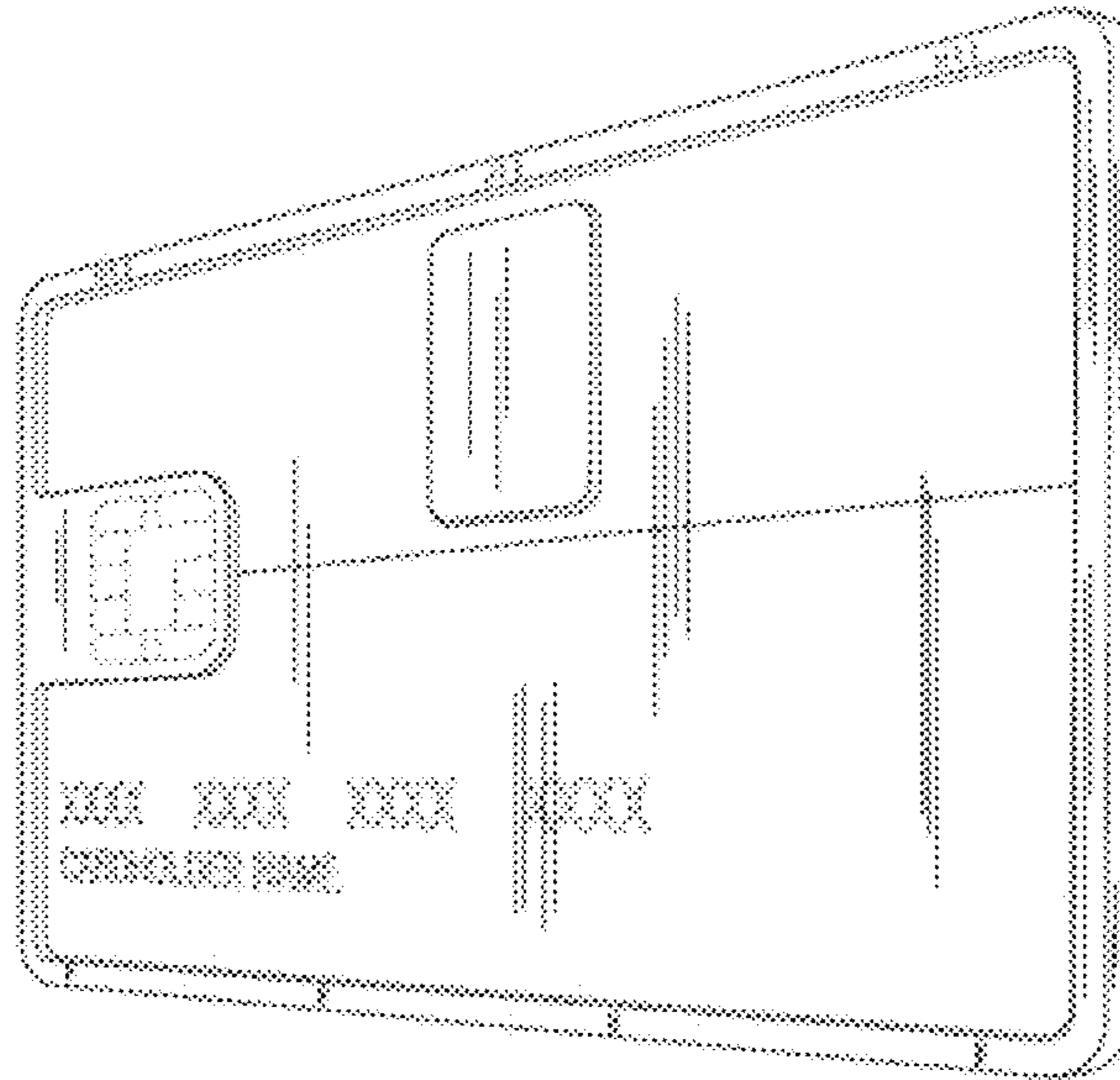

FIG. 9

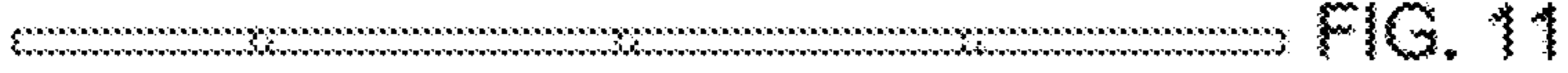

FIG. 11

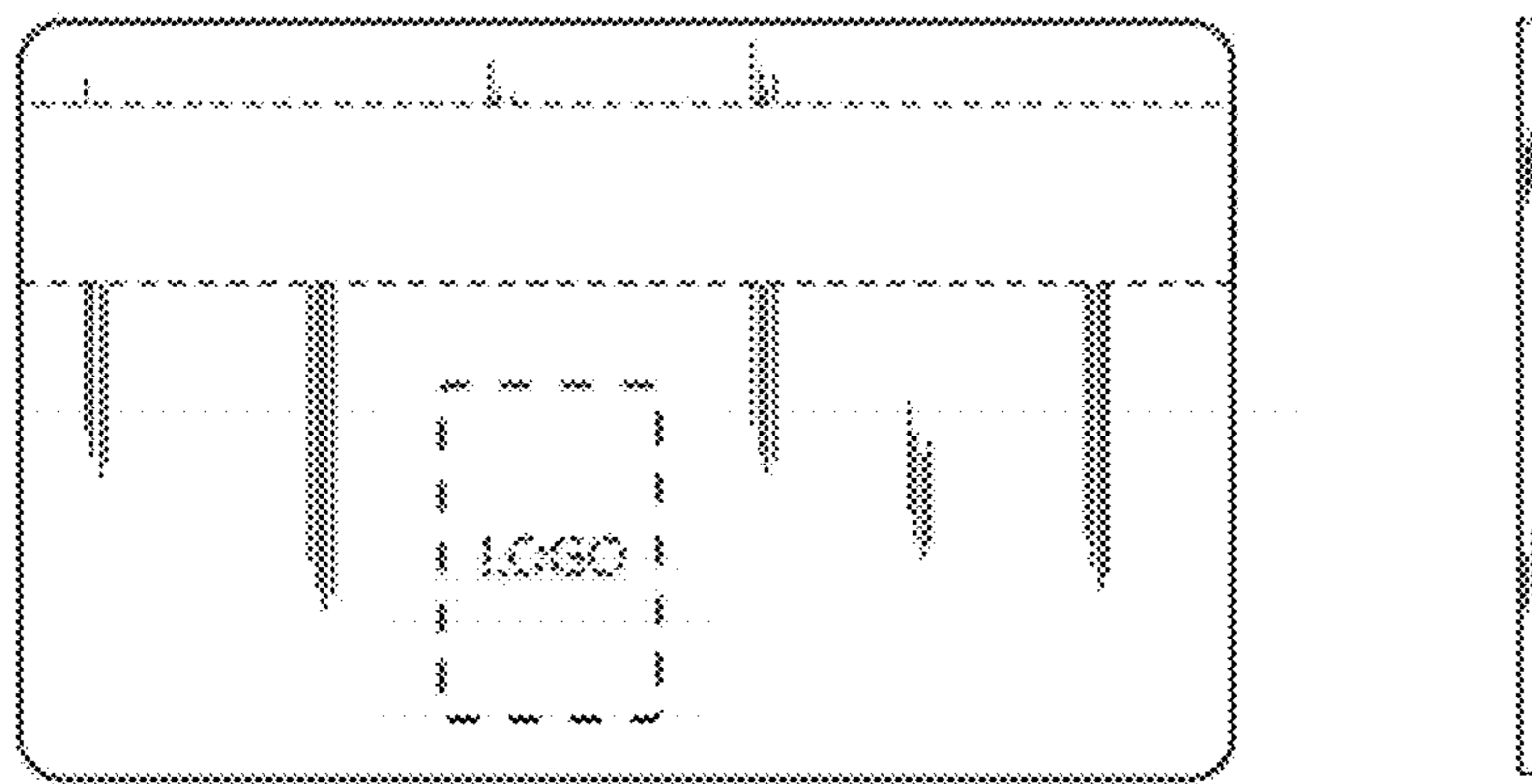

FIG. 10

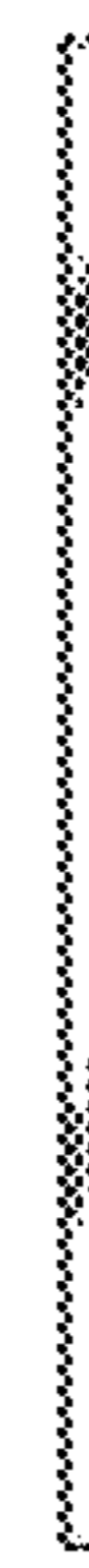

FIG. 12

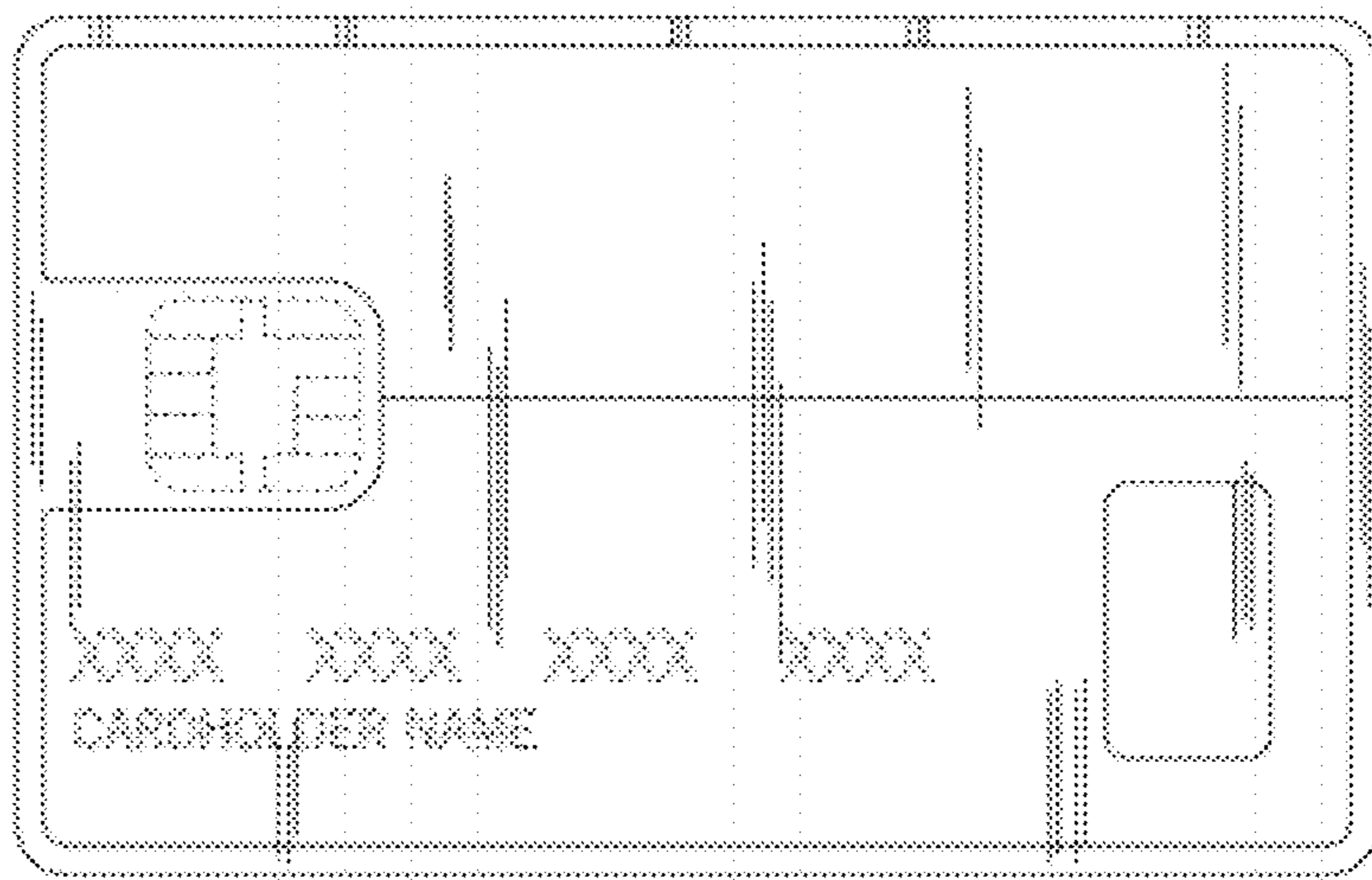

FIG. 13

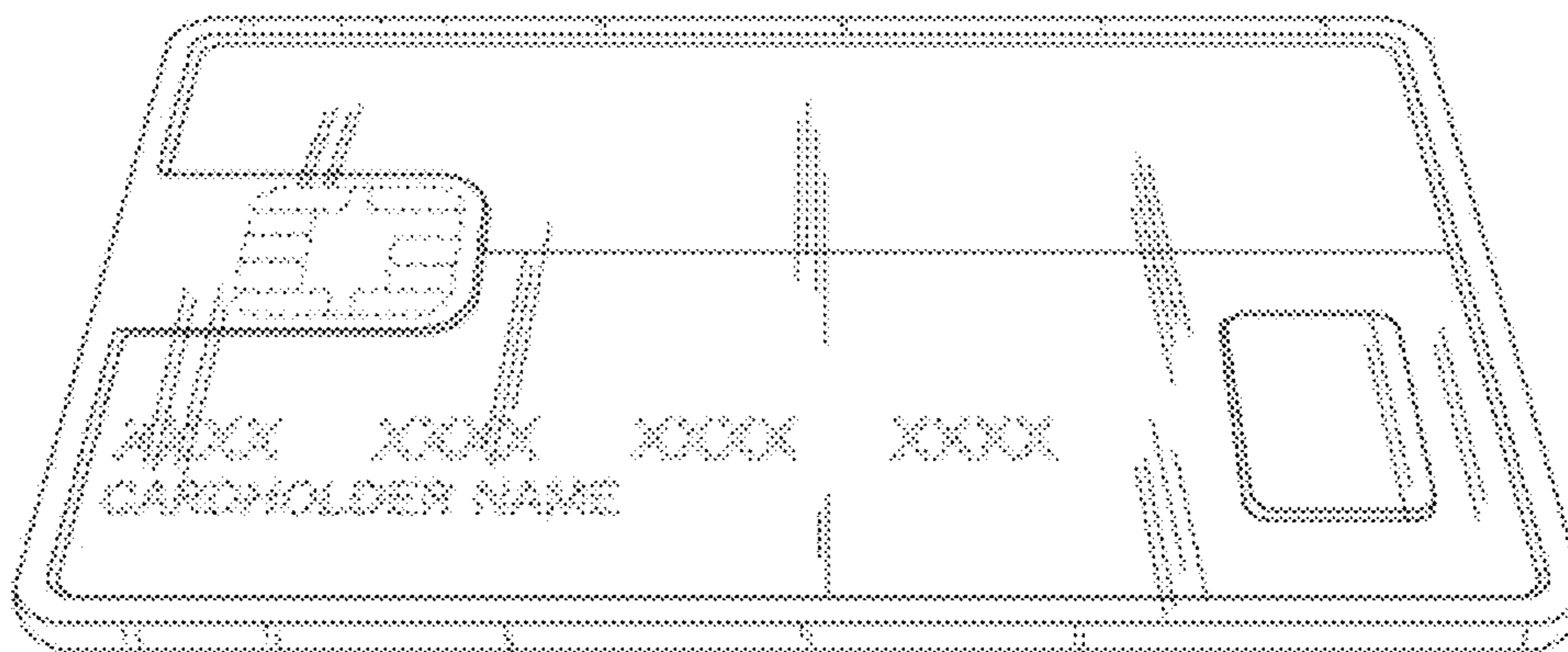

FIG. 14

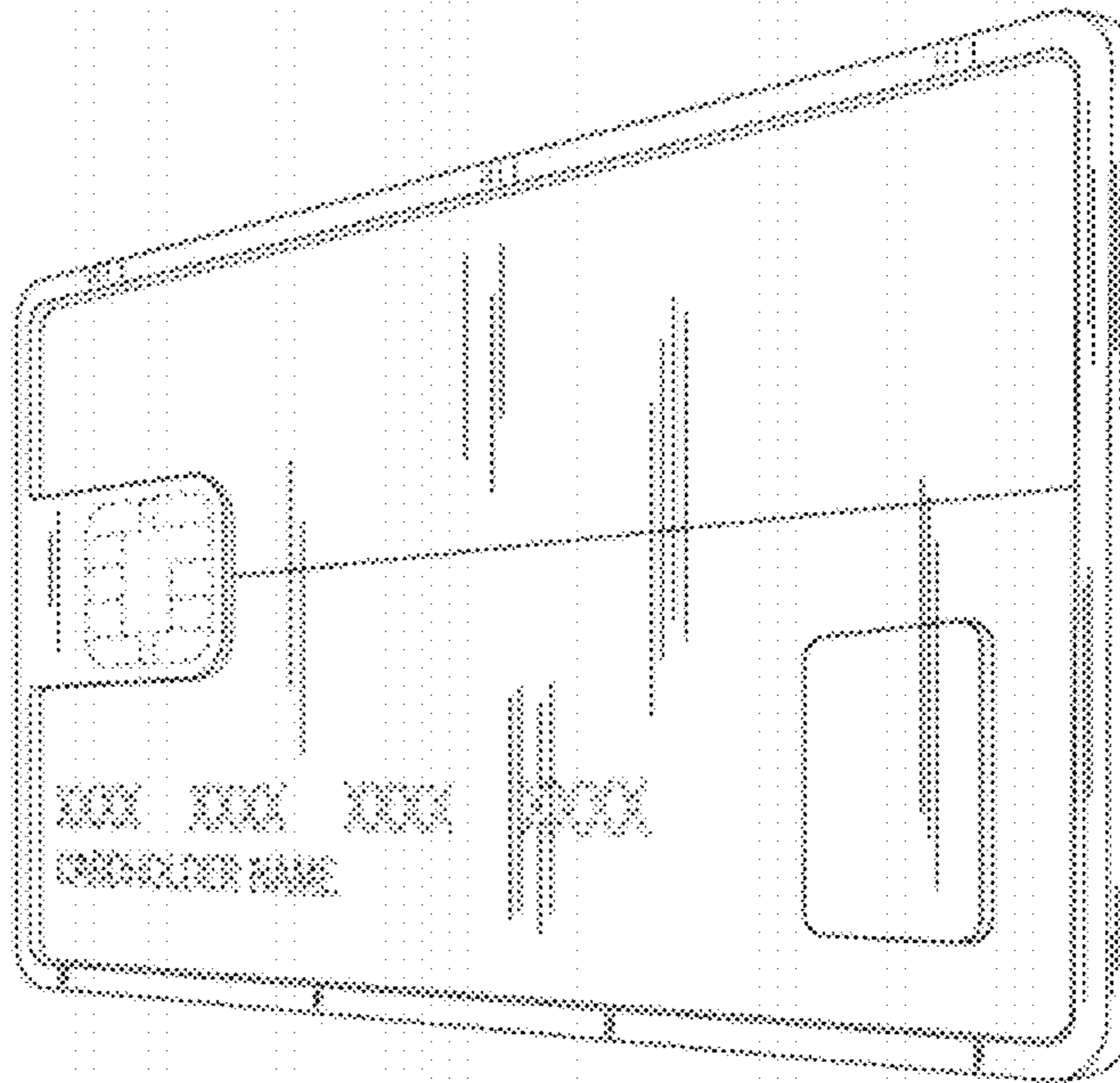

FIG. 15

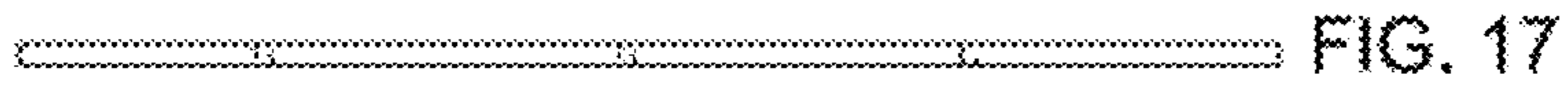

FIG. 17

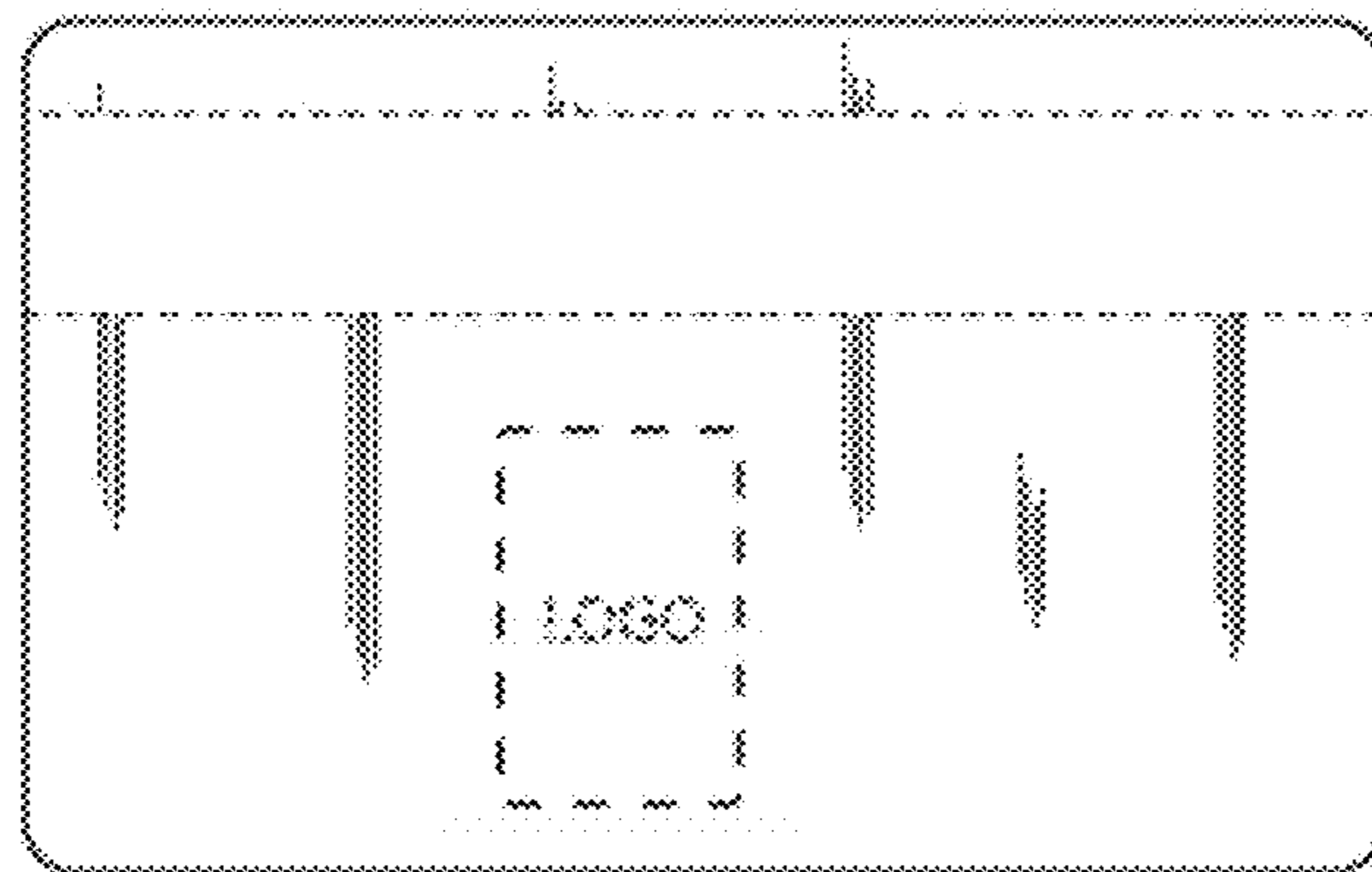

FIG. 16

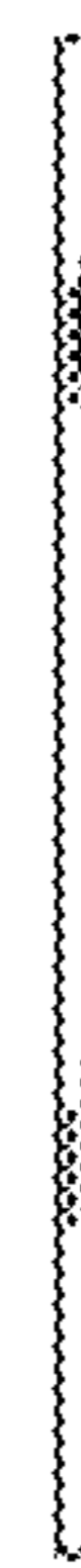

FIG. 18

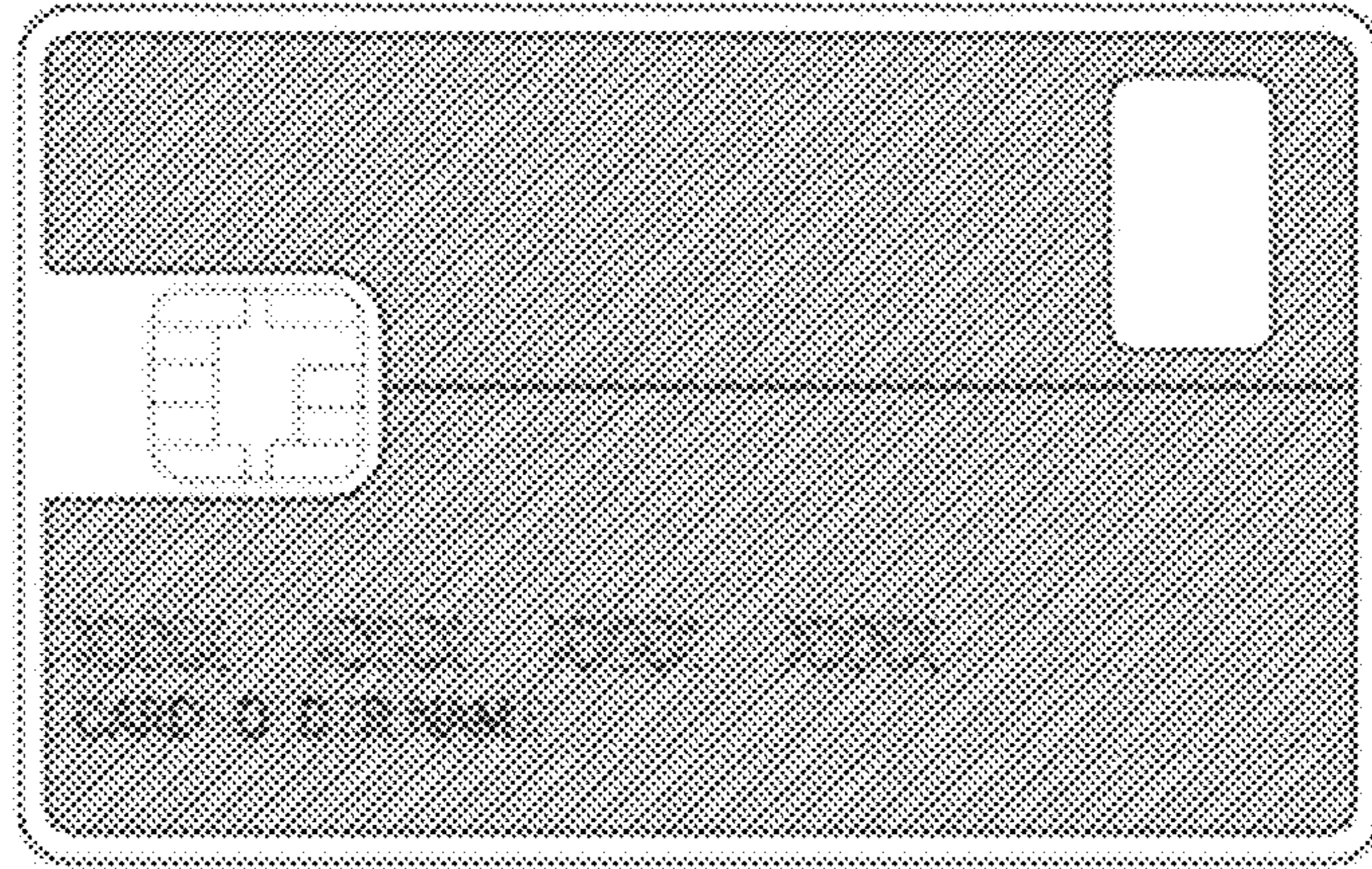

FIG. 19

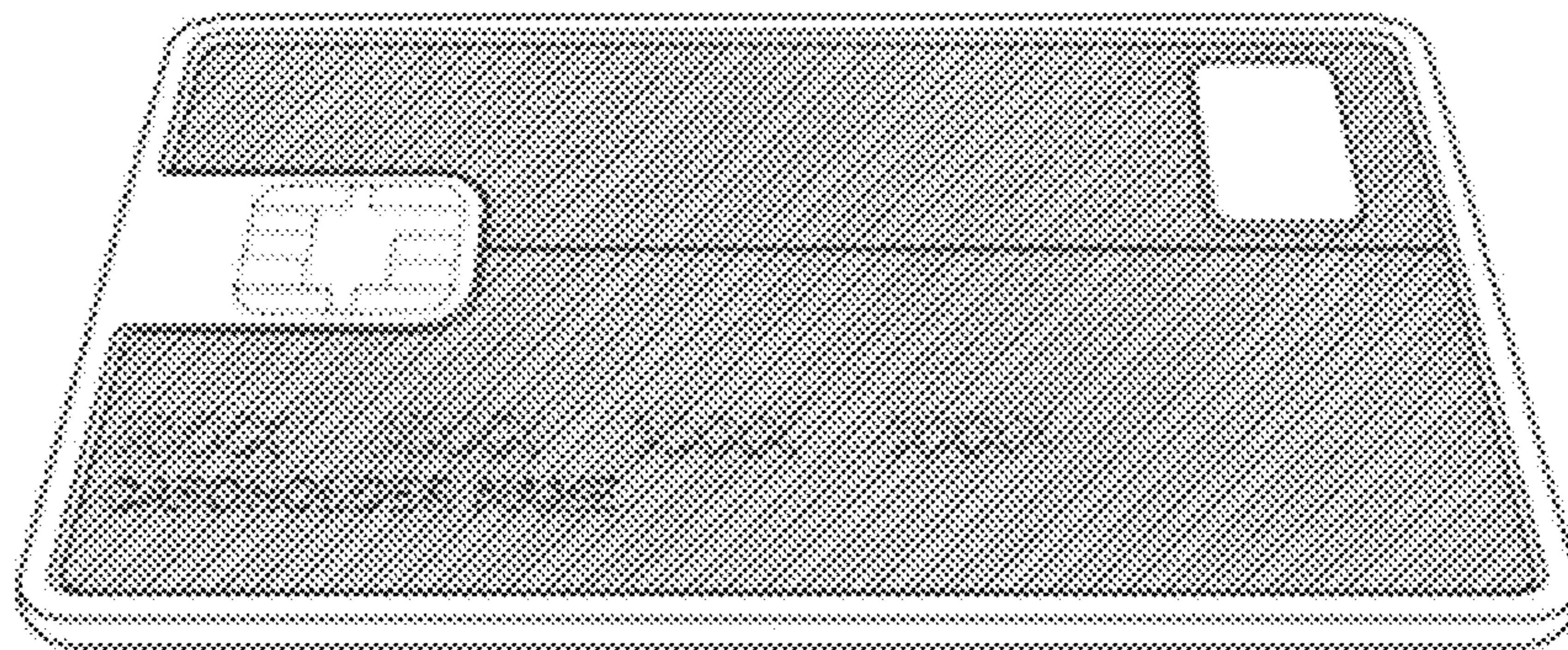

FIG. 20

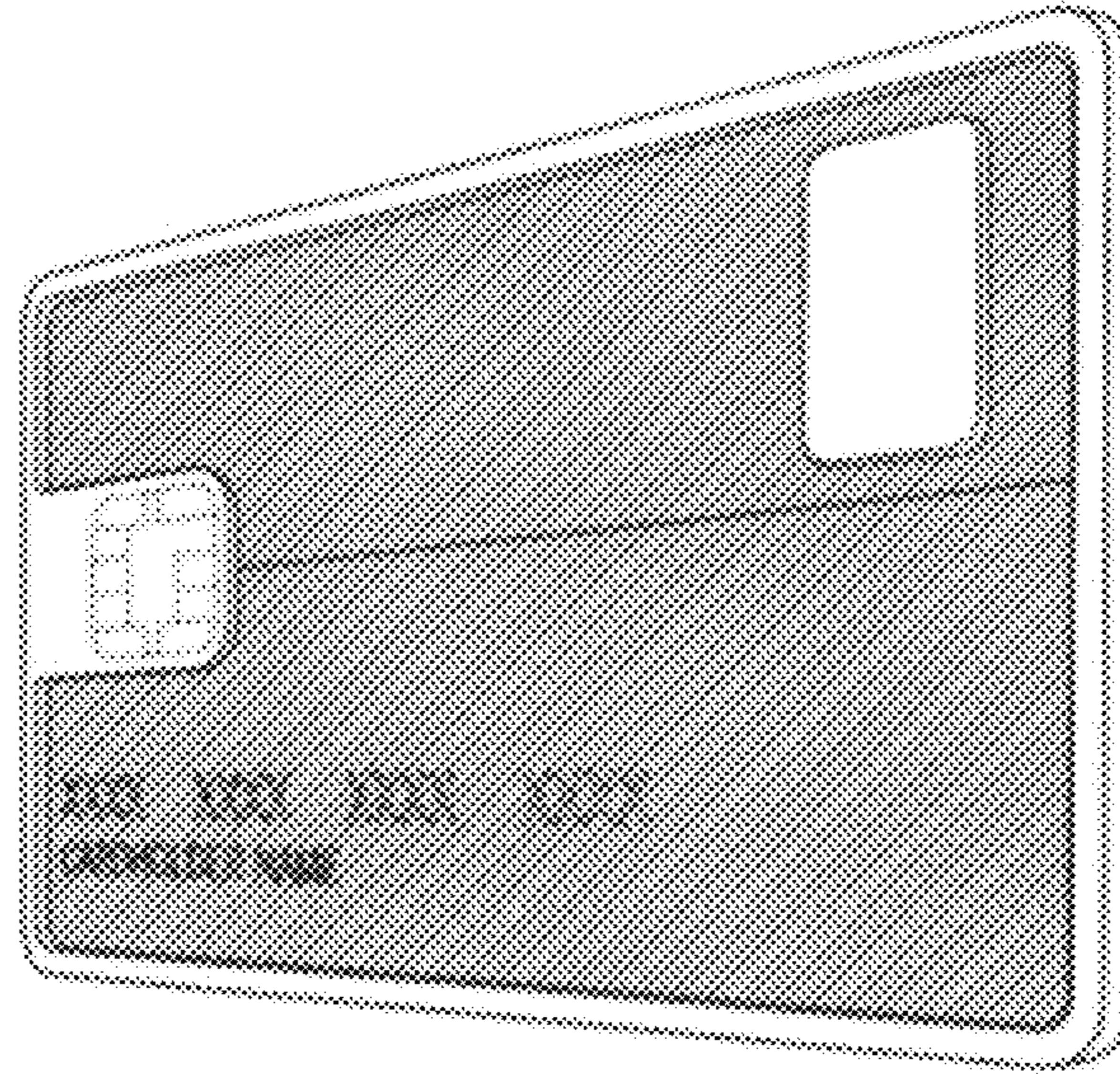

FIG. 21

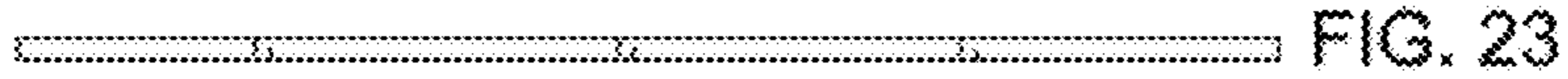

FIG. 23

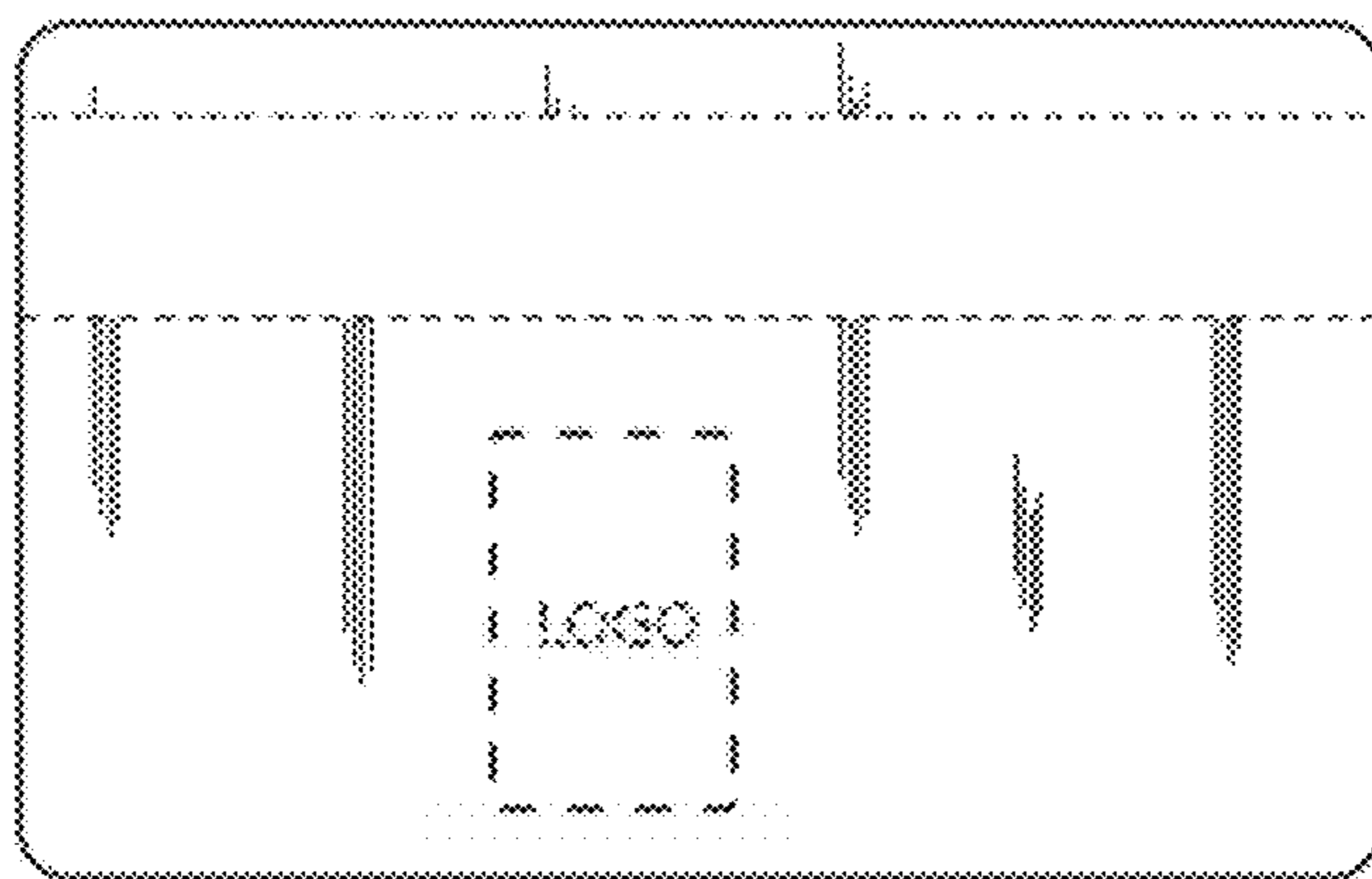

FIG. 22

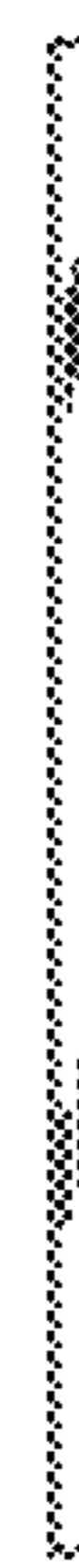

FIG. 24

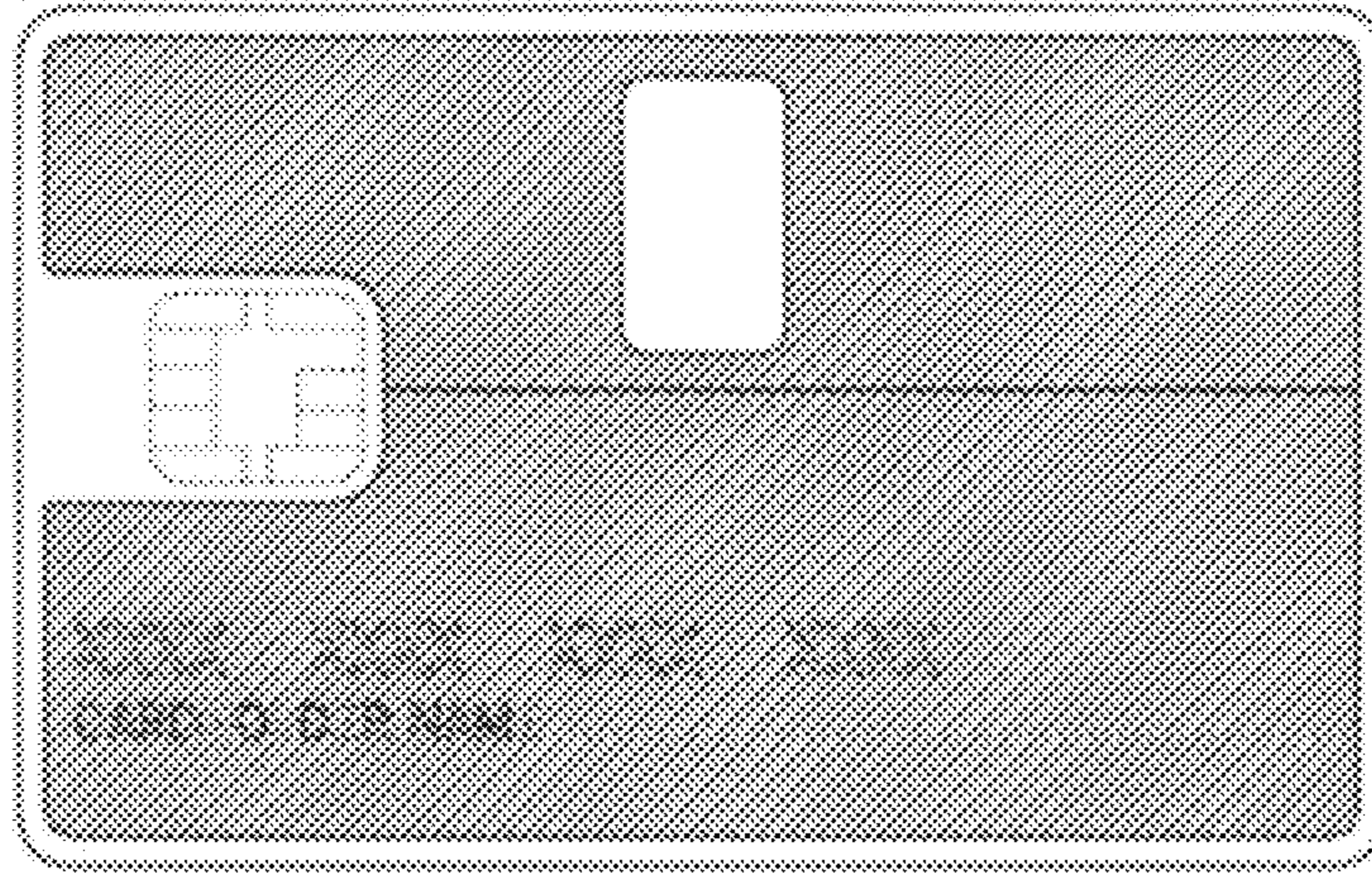

FIG. 25

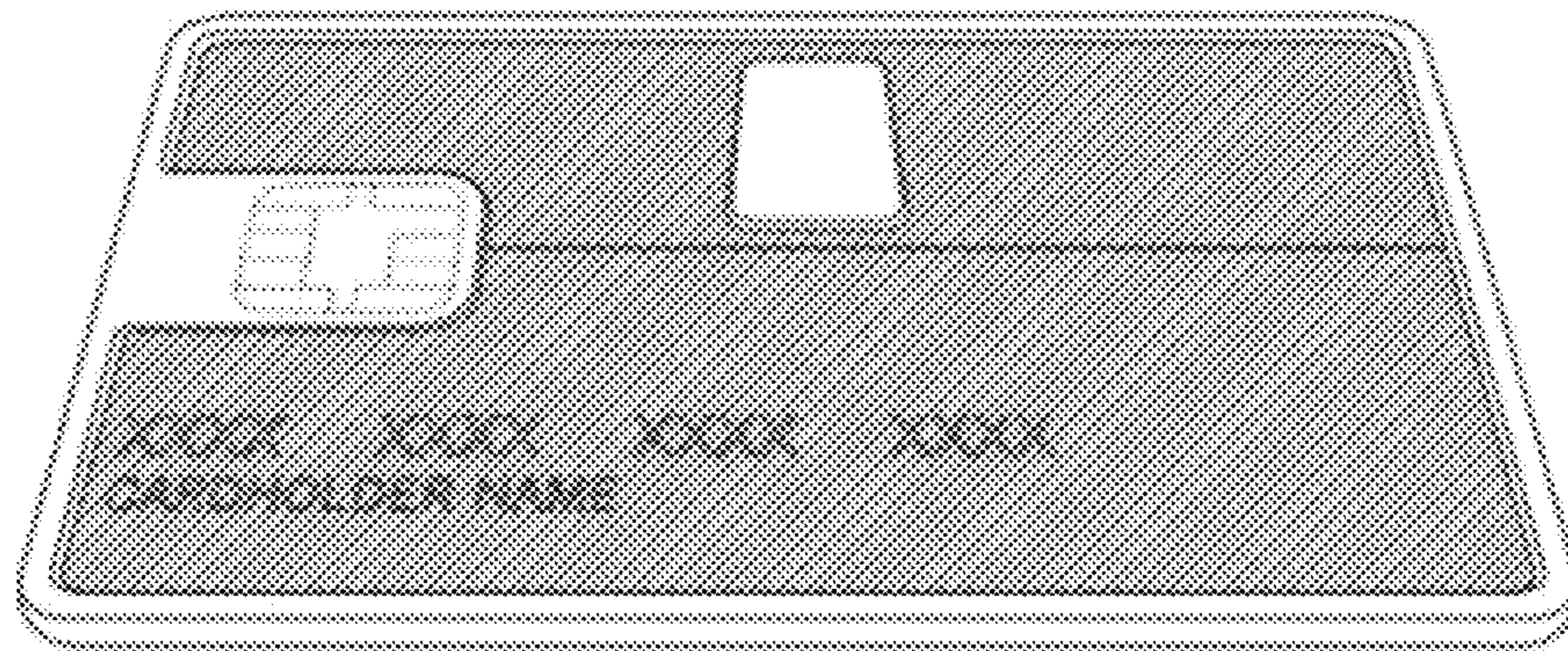

FIG. 26

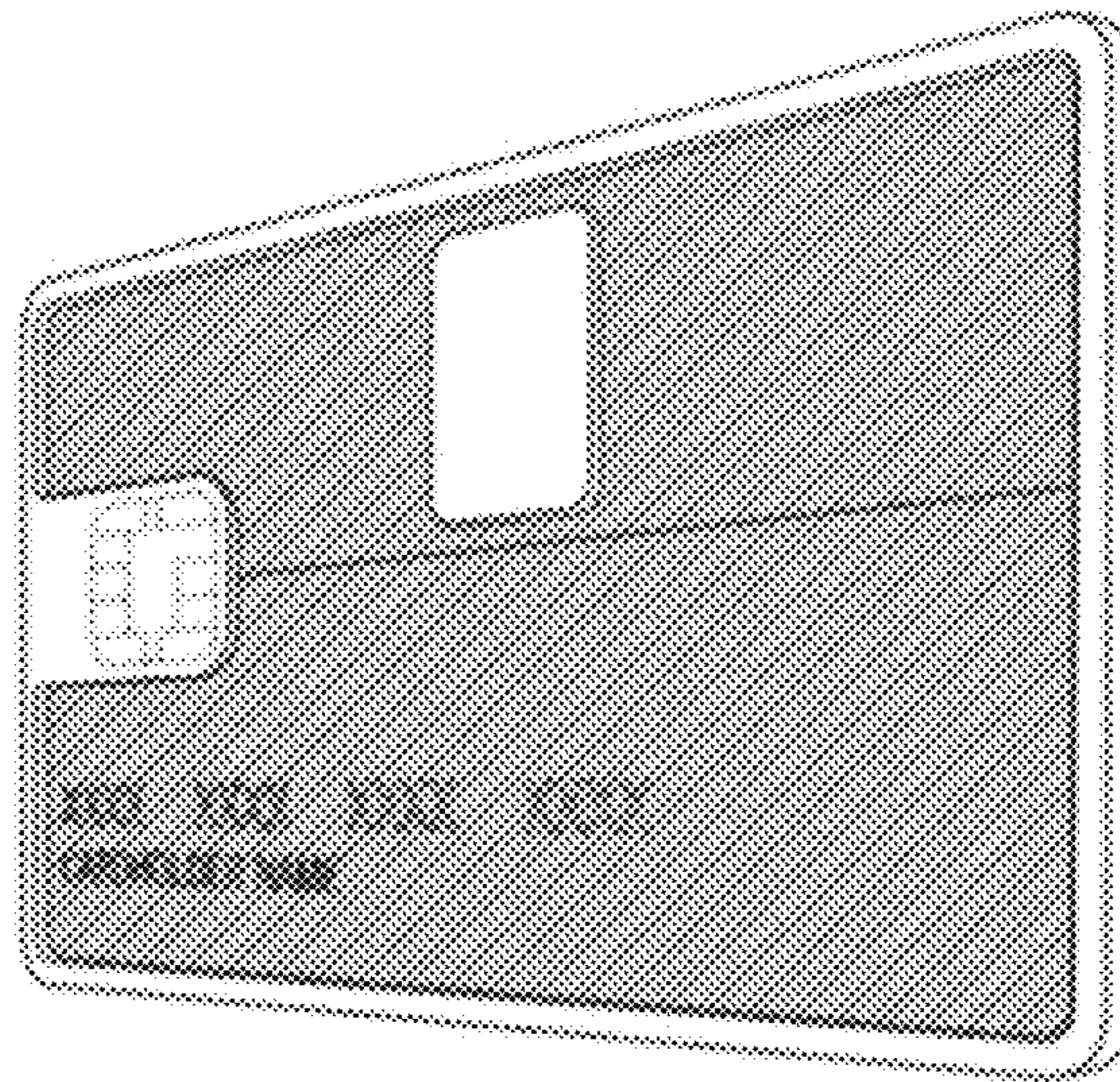

FIG. 27

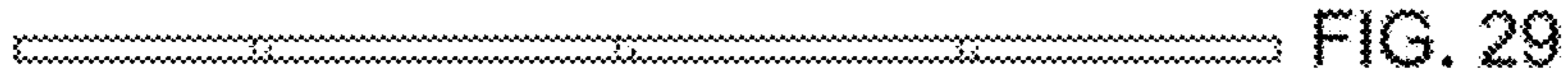

FIG. 29

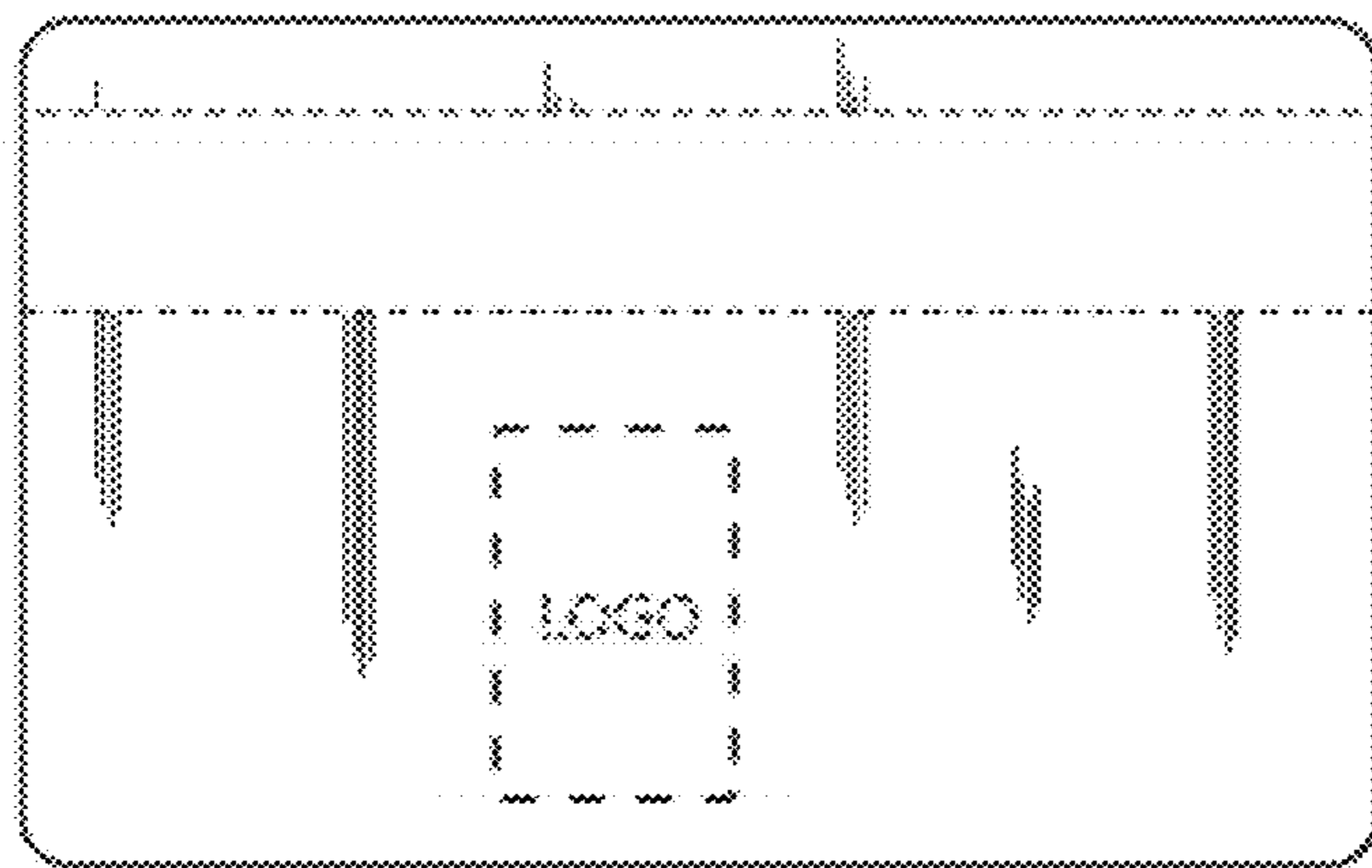

FIG. 28



FIG. 30

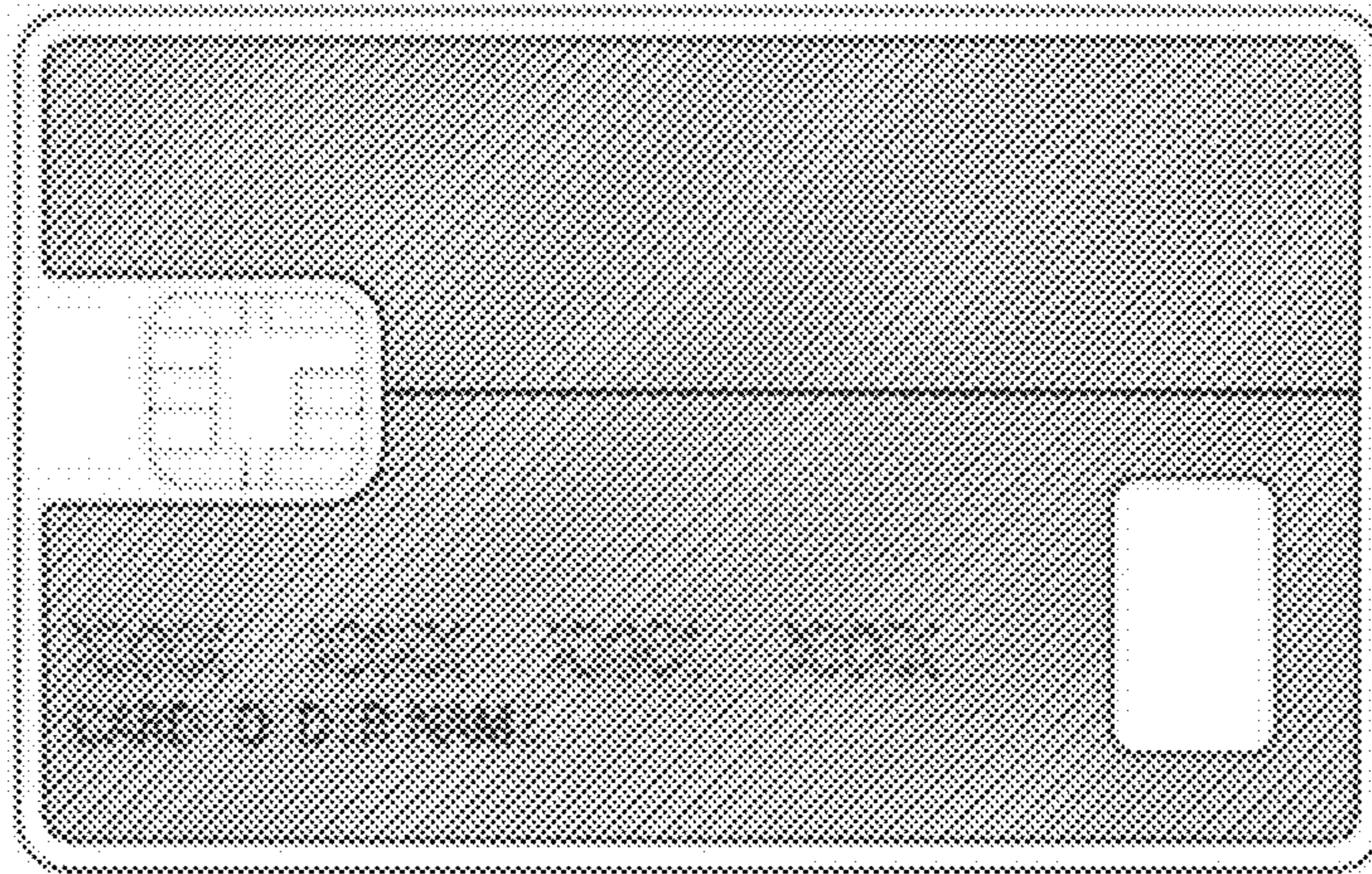

FIG. 31

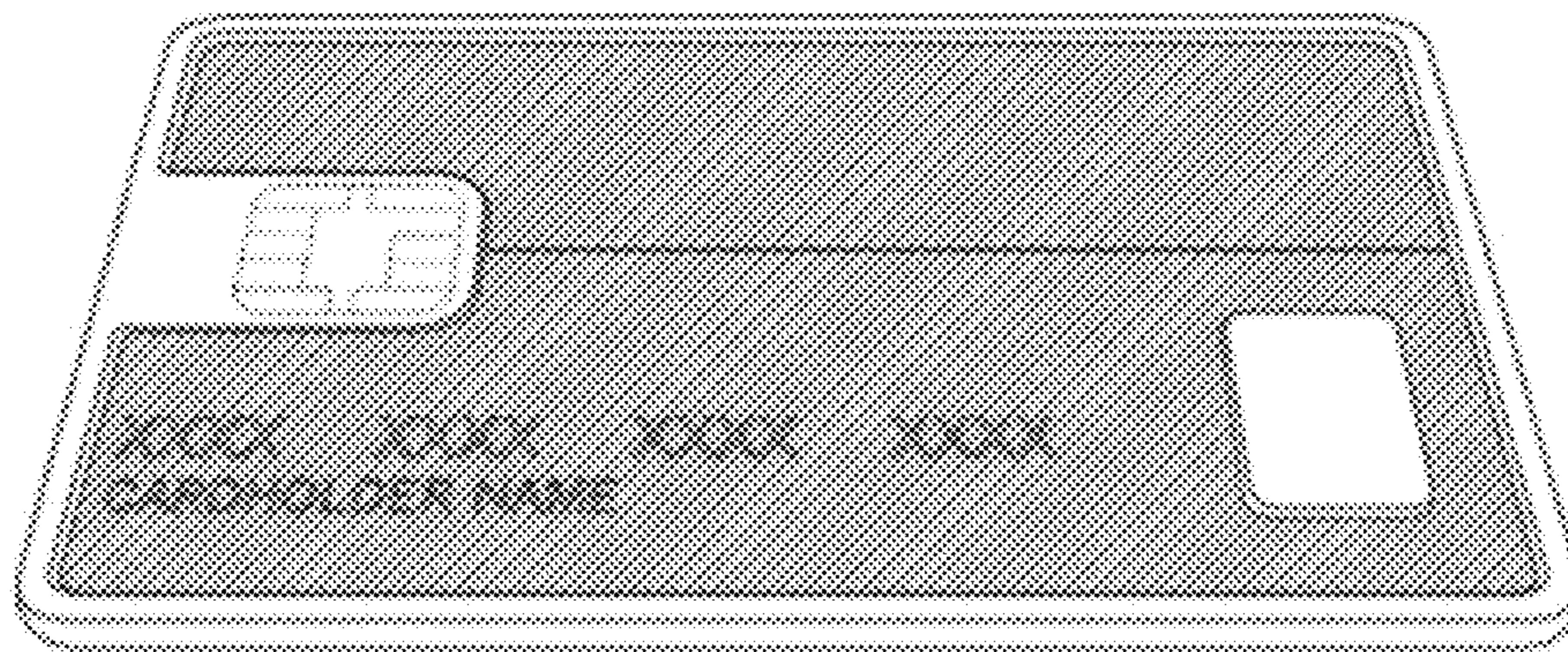

FIG. 32

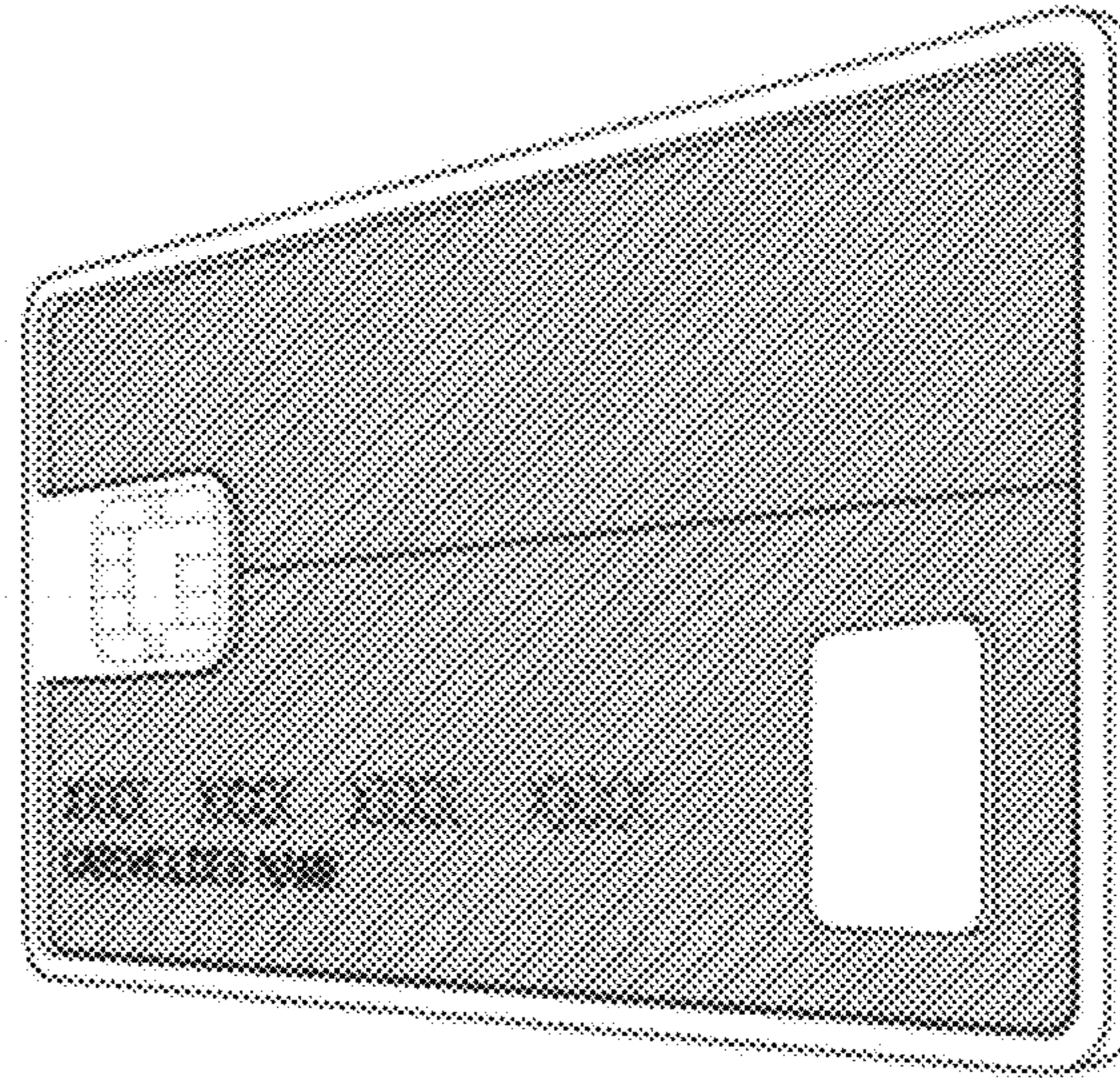

FIG. 33

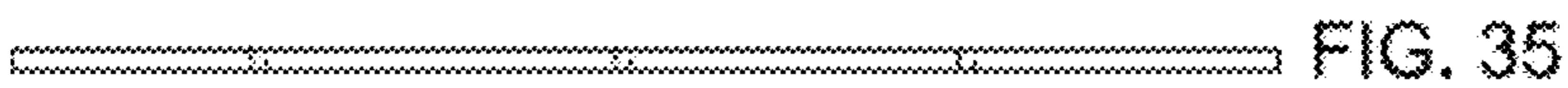

FIG. 35

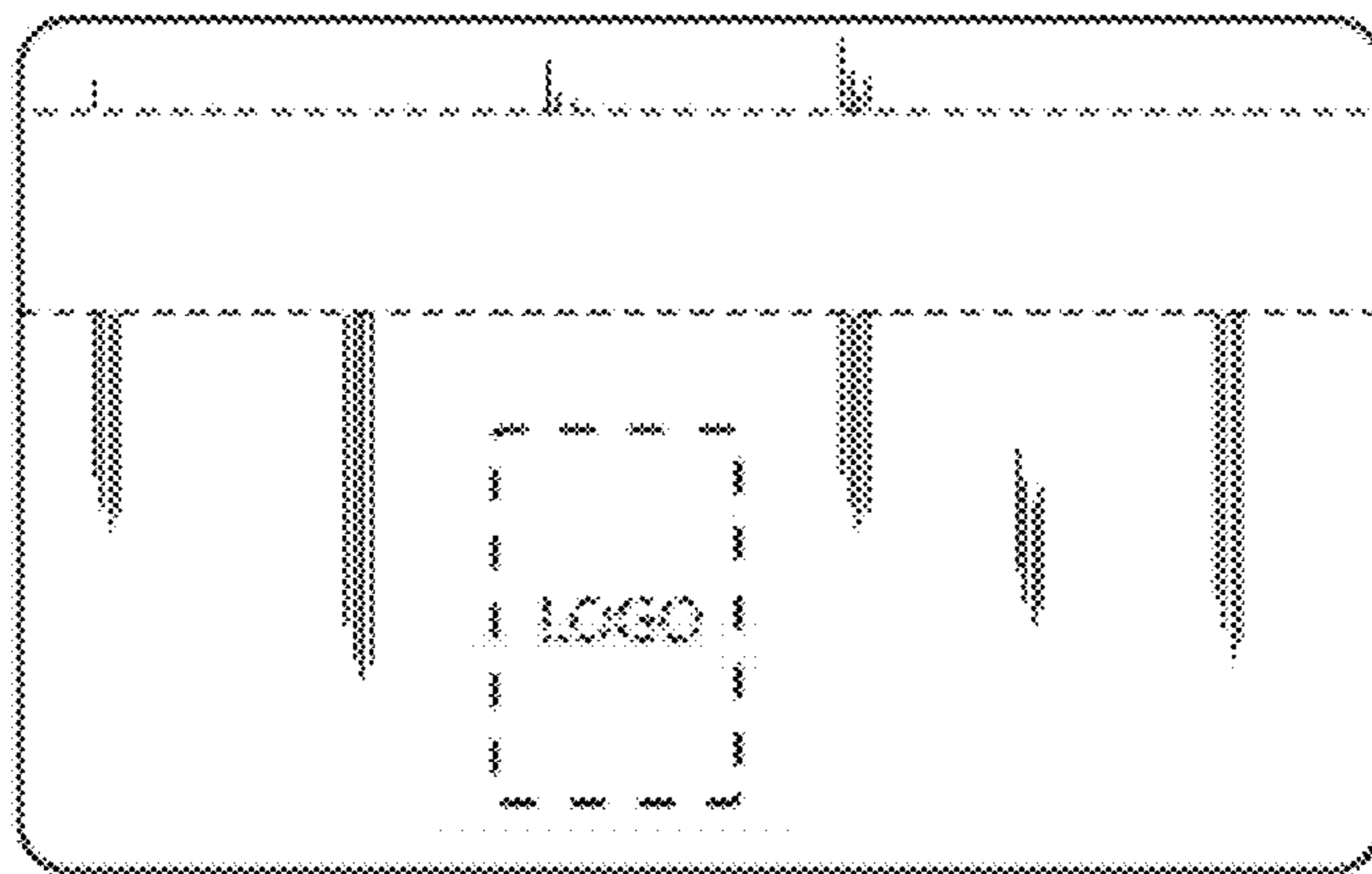

FIG. 34

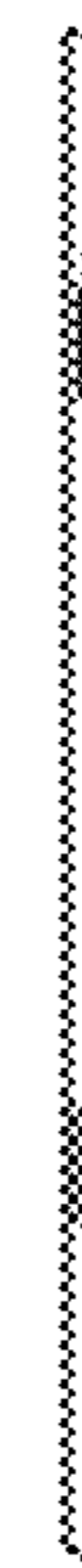

FIG. 36

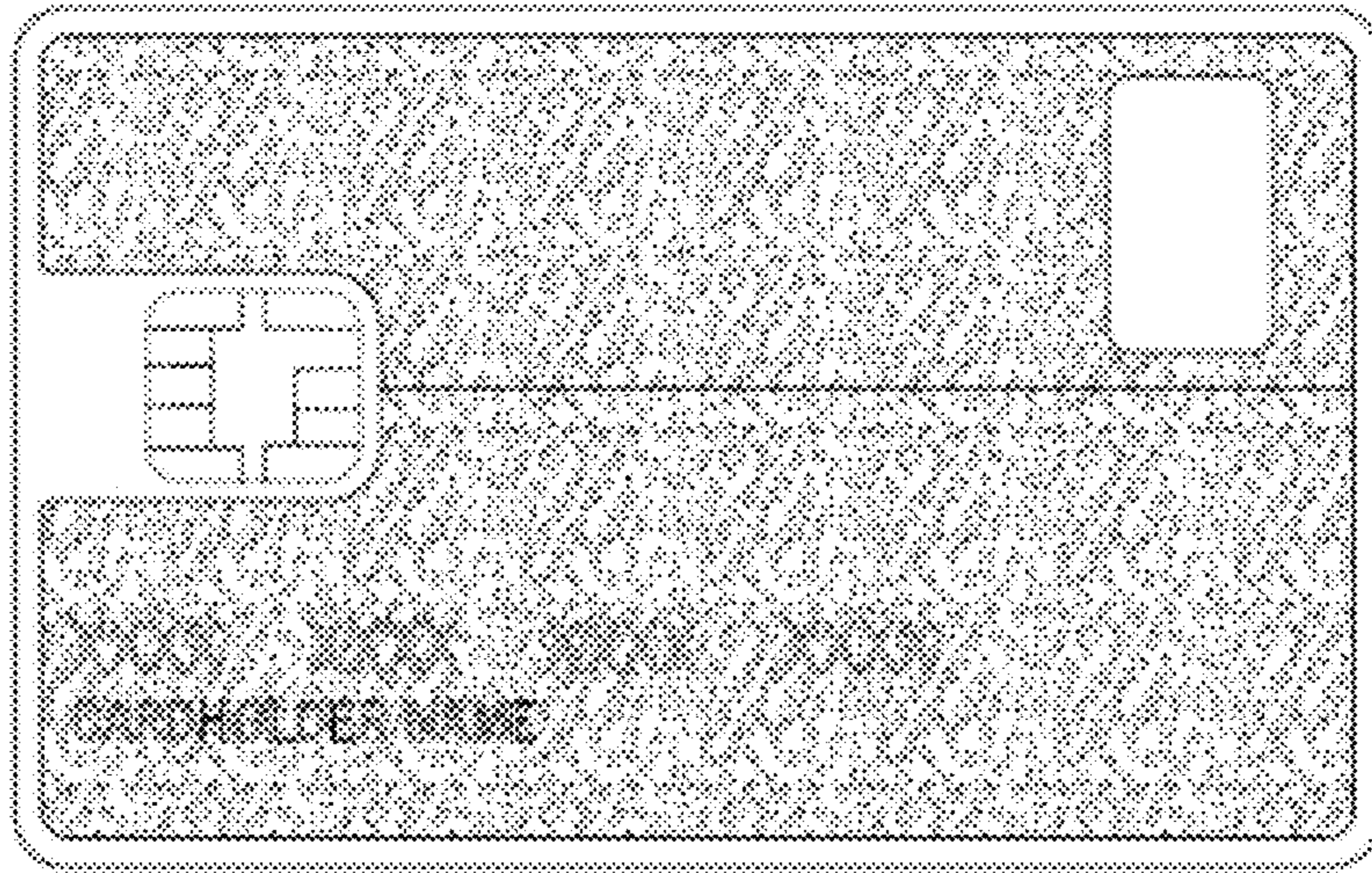

FIG. 37

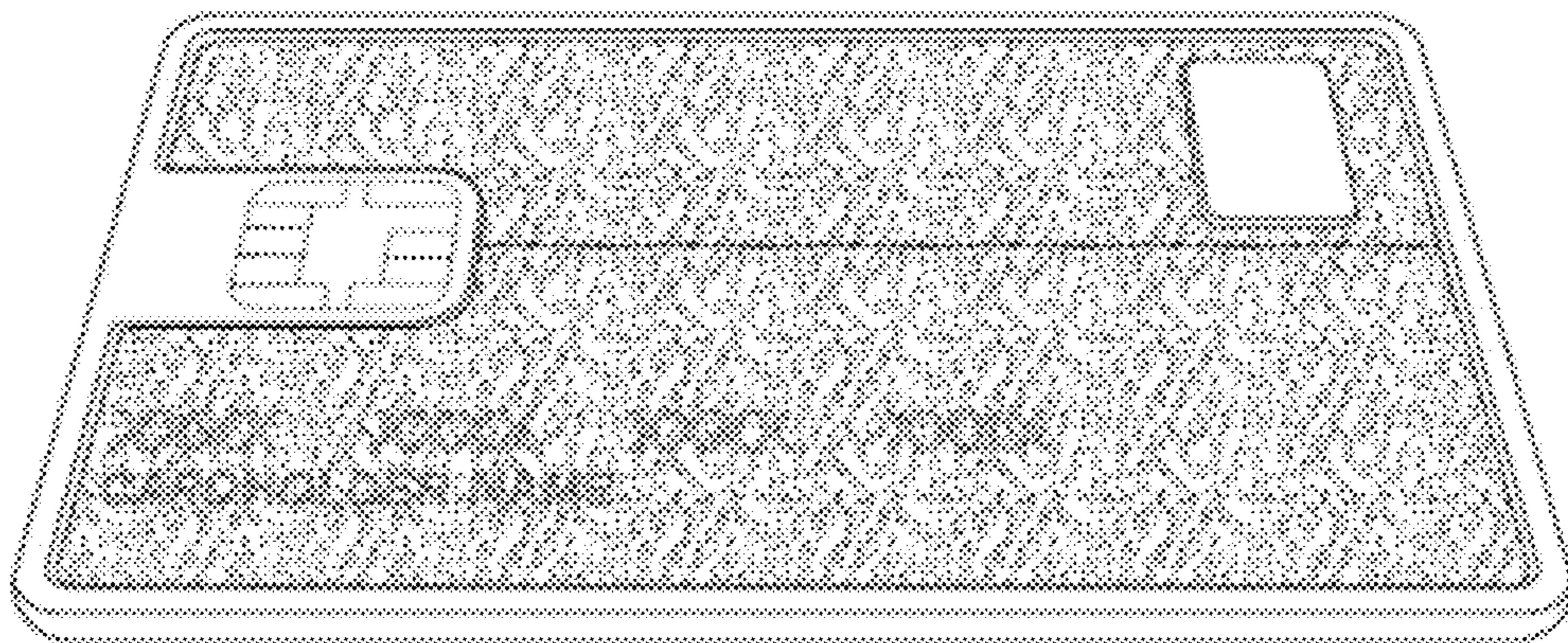

FIG. 38

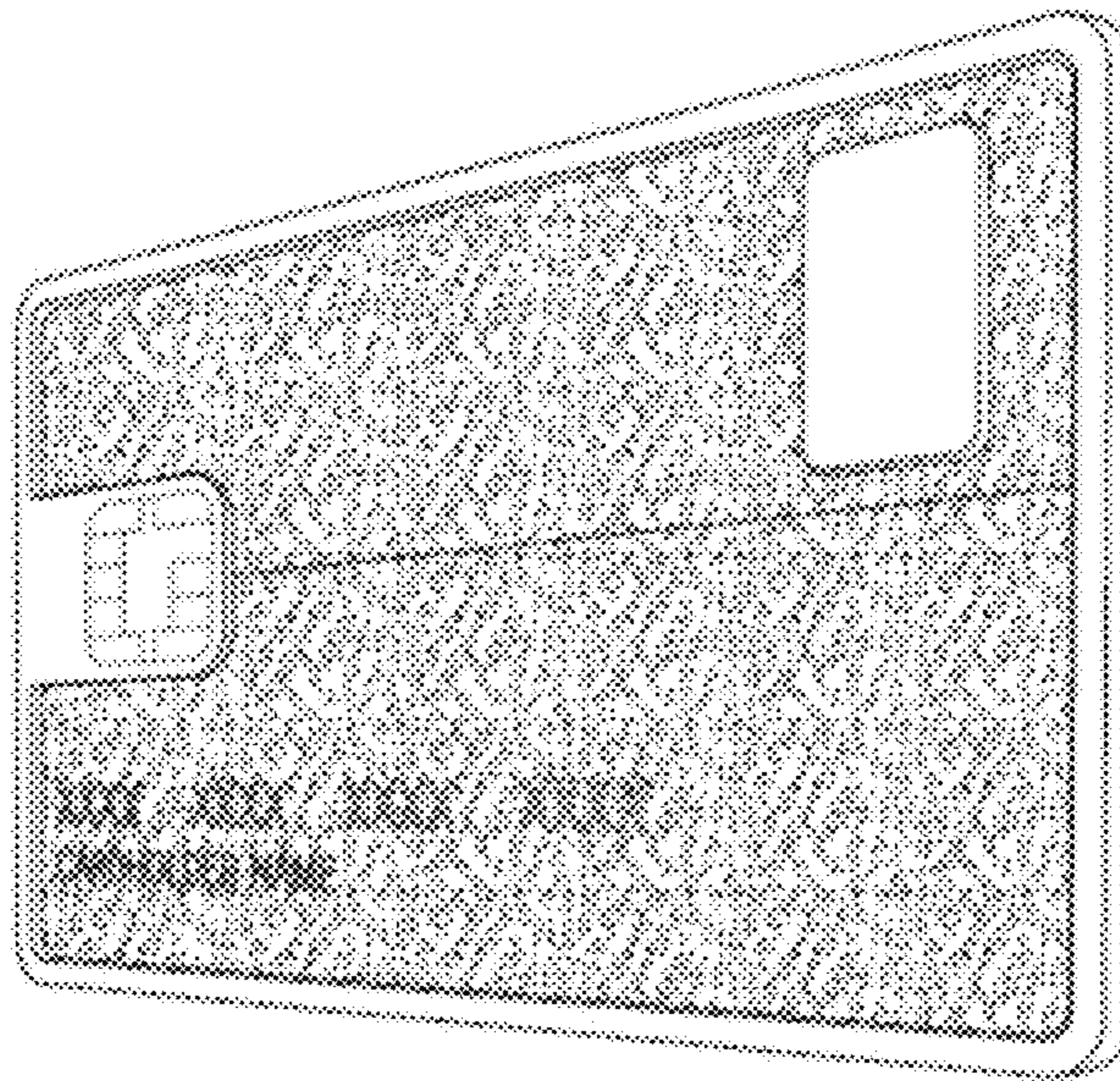

FIG. 39

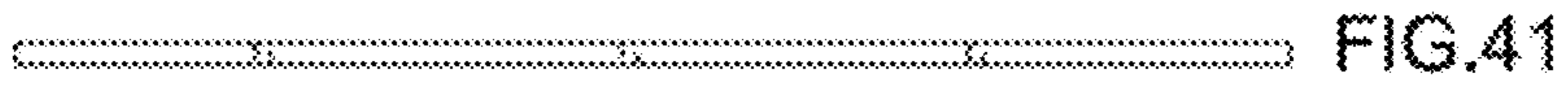

FIG. 41

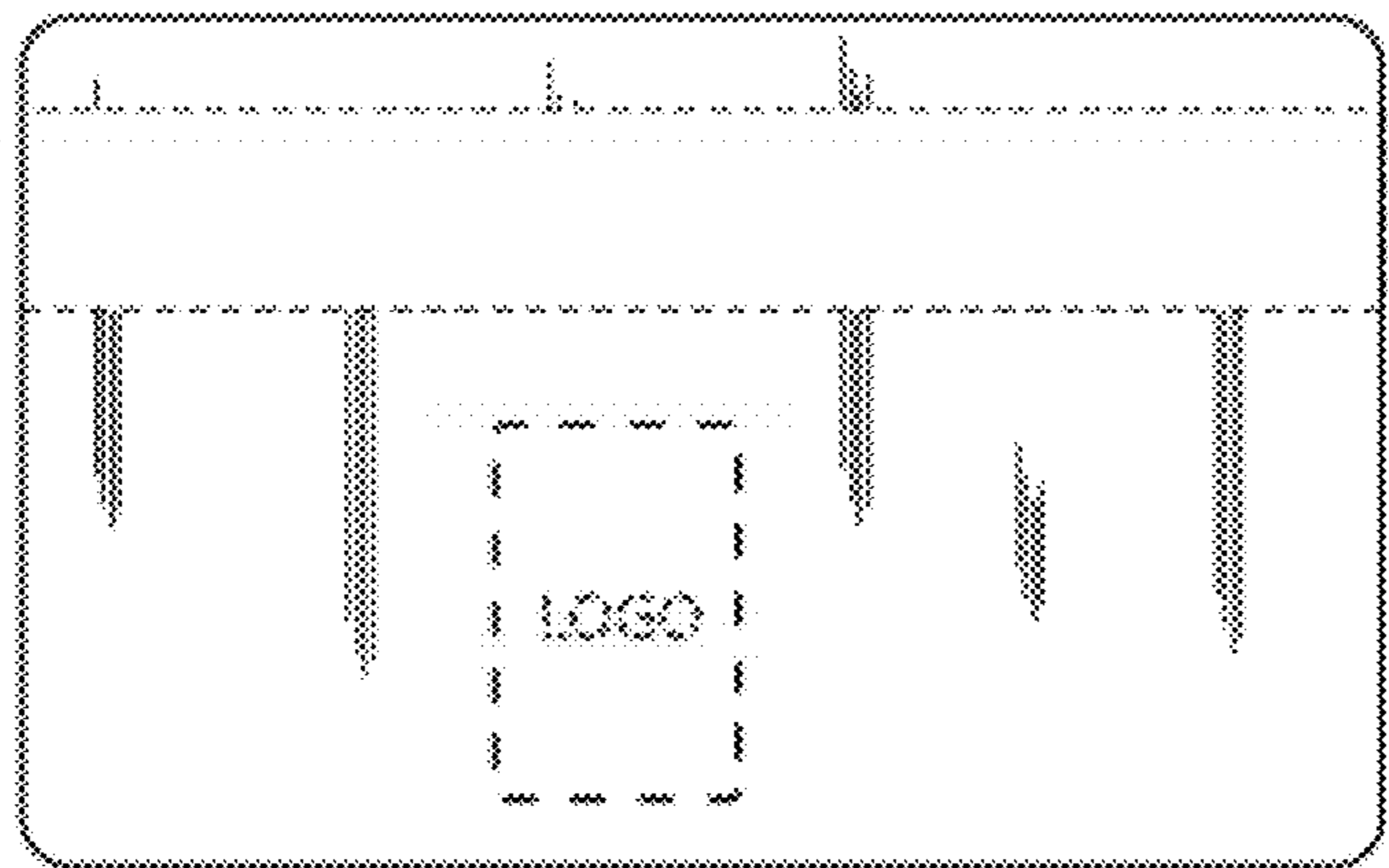

FIG. 40

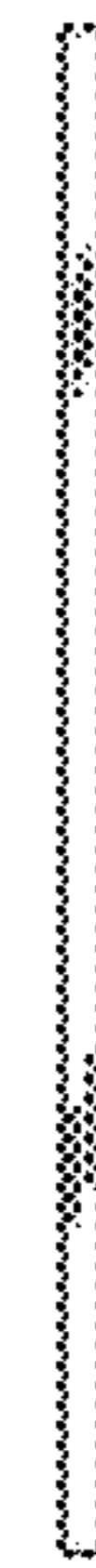

FIG. 42

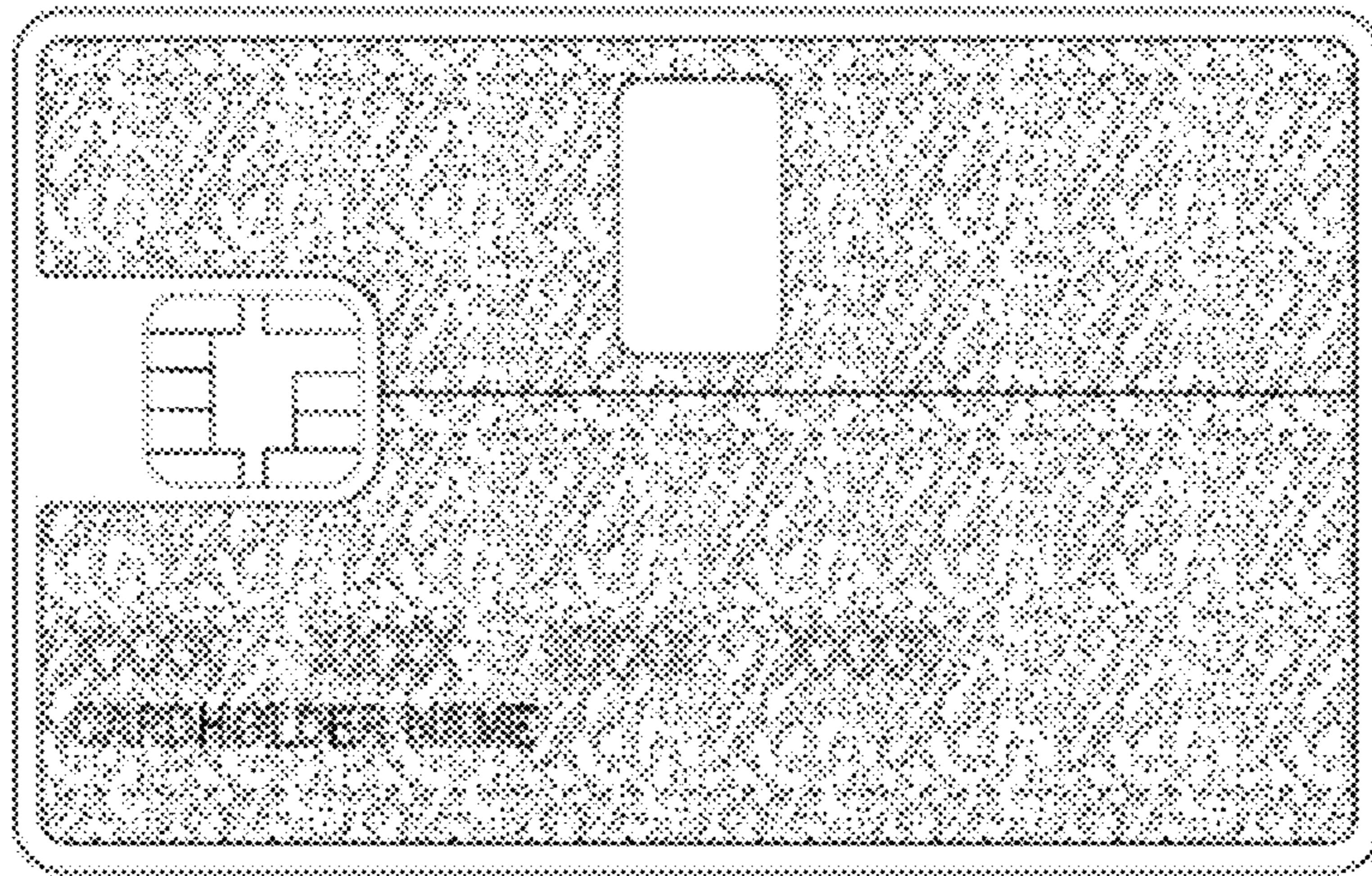

FIG. 43

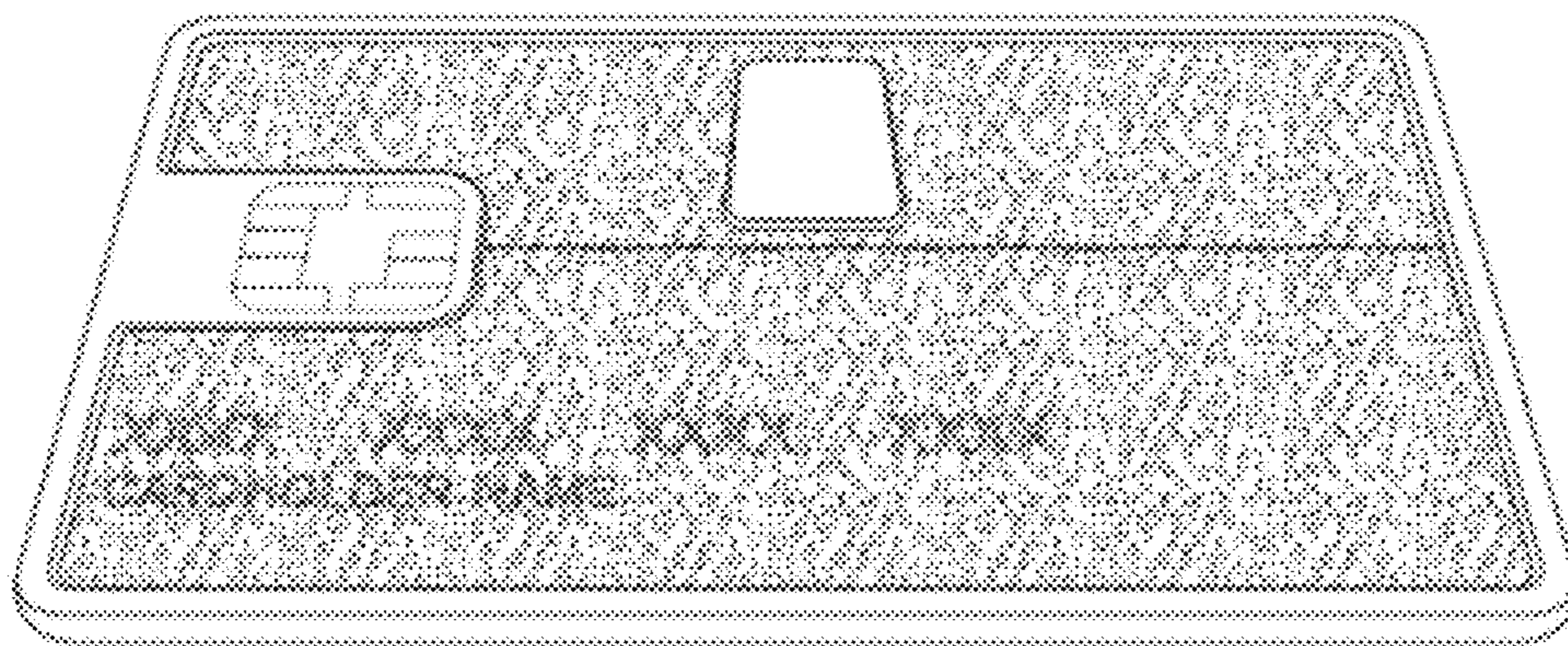

FIG. 44

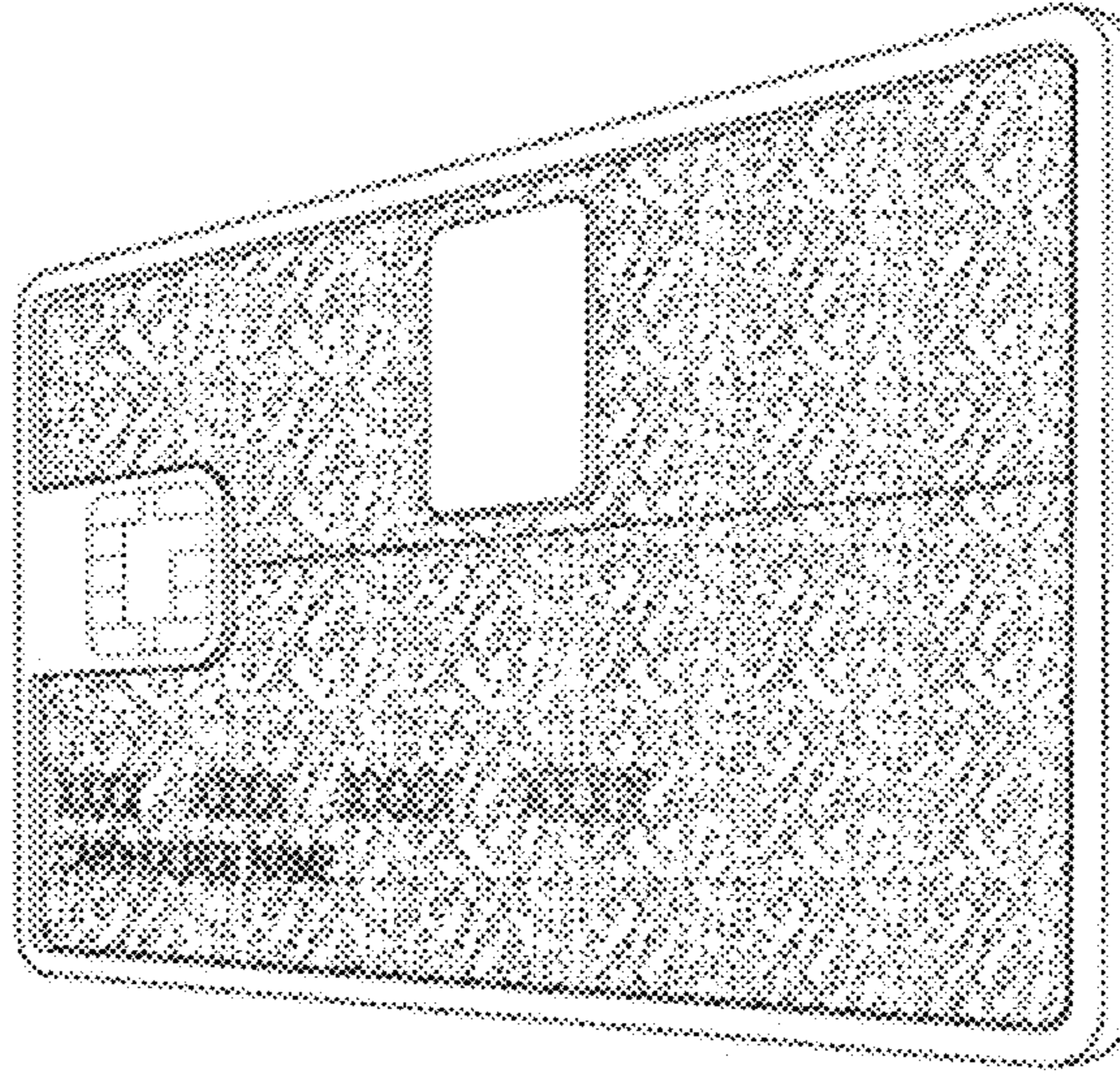

FIG. 45

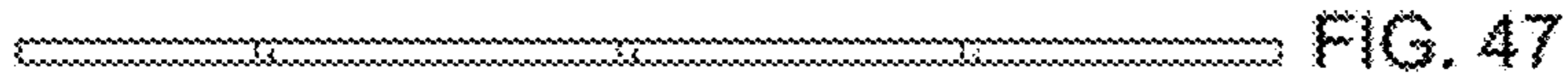

FIG. 47

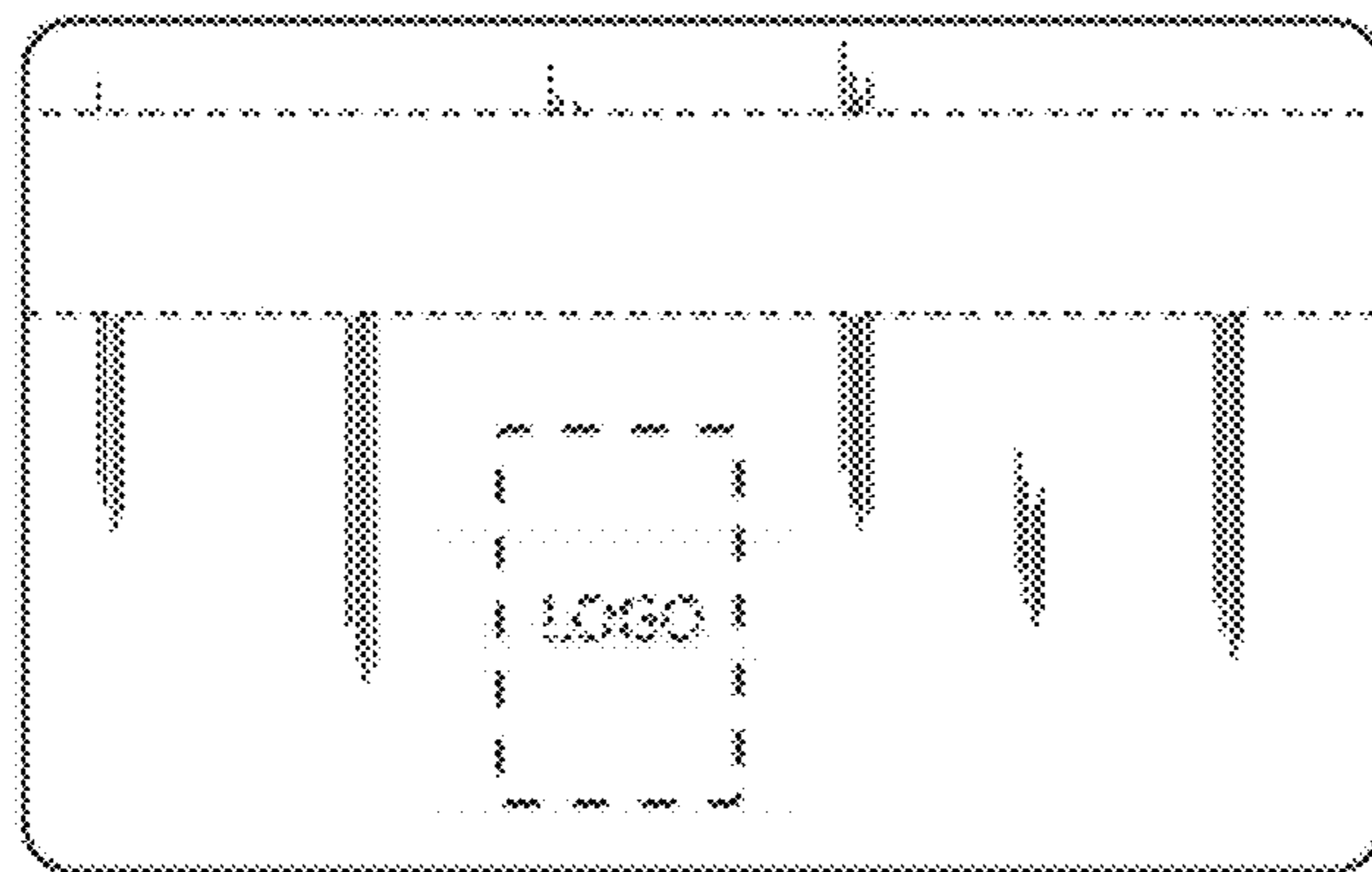

FIG. 46

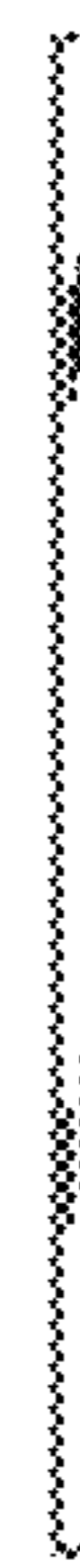

FIG. 48

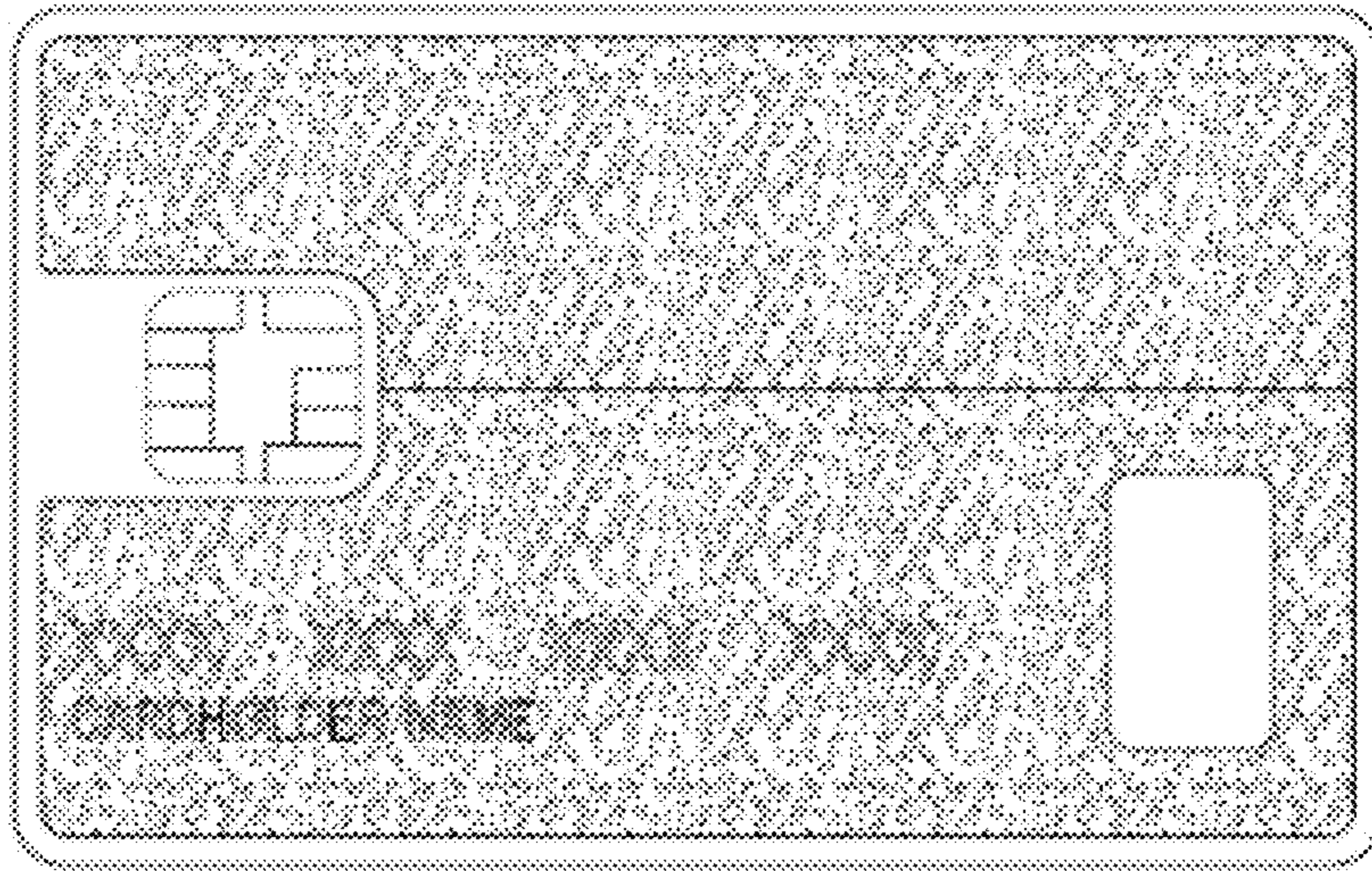

FIG. 49

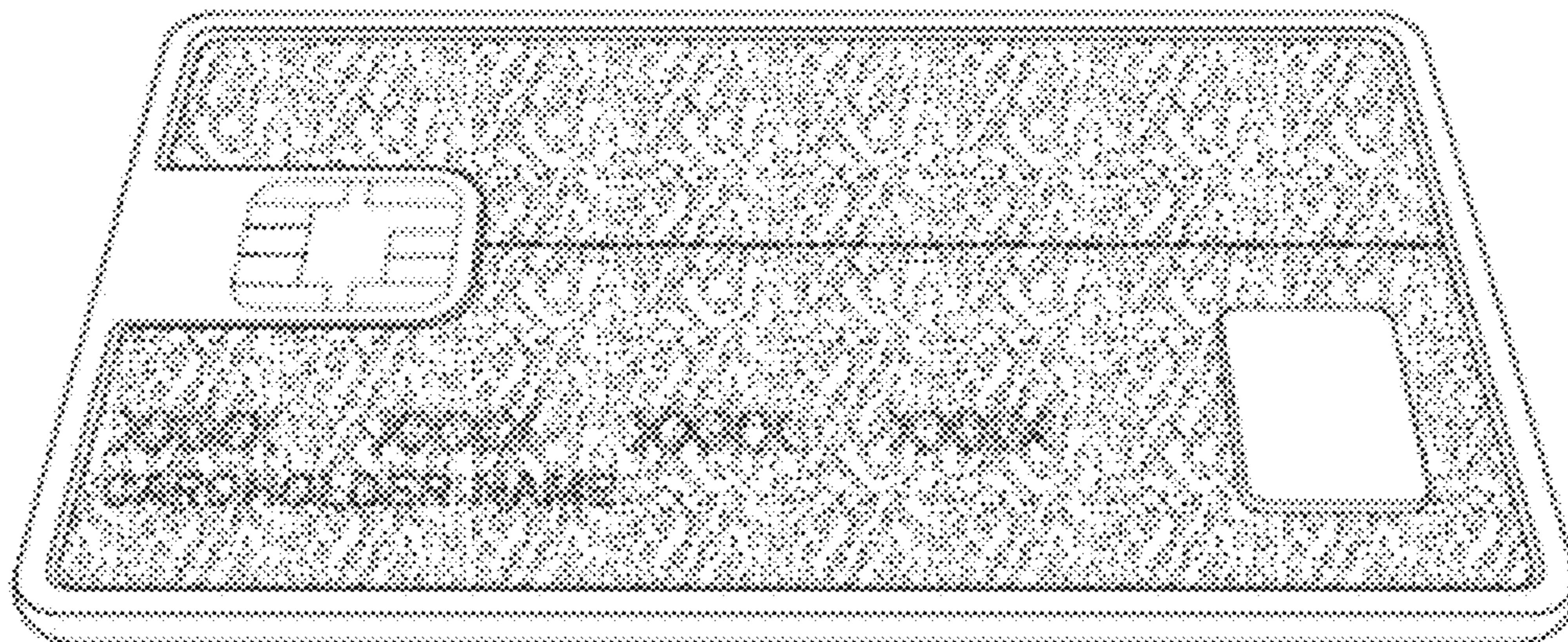

FIG. 50

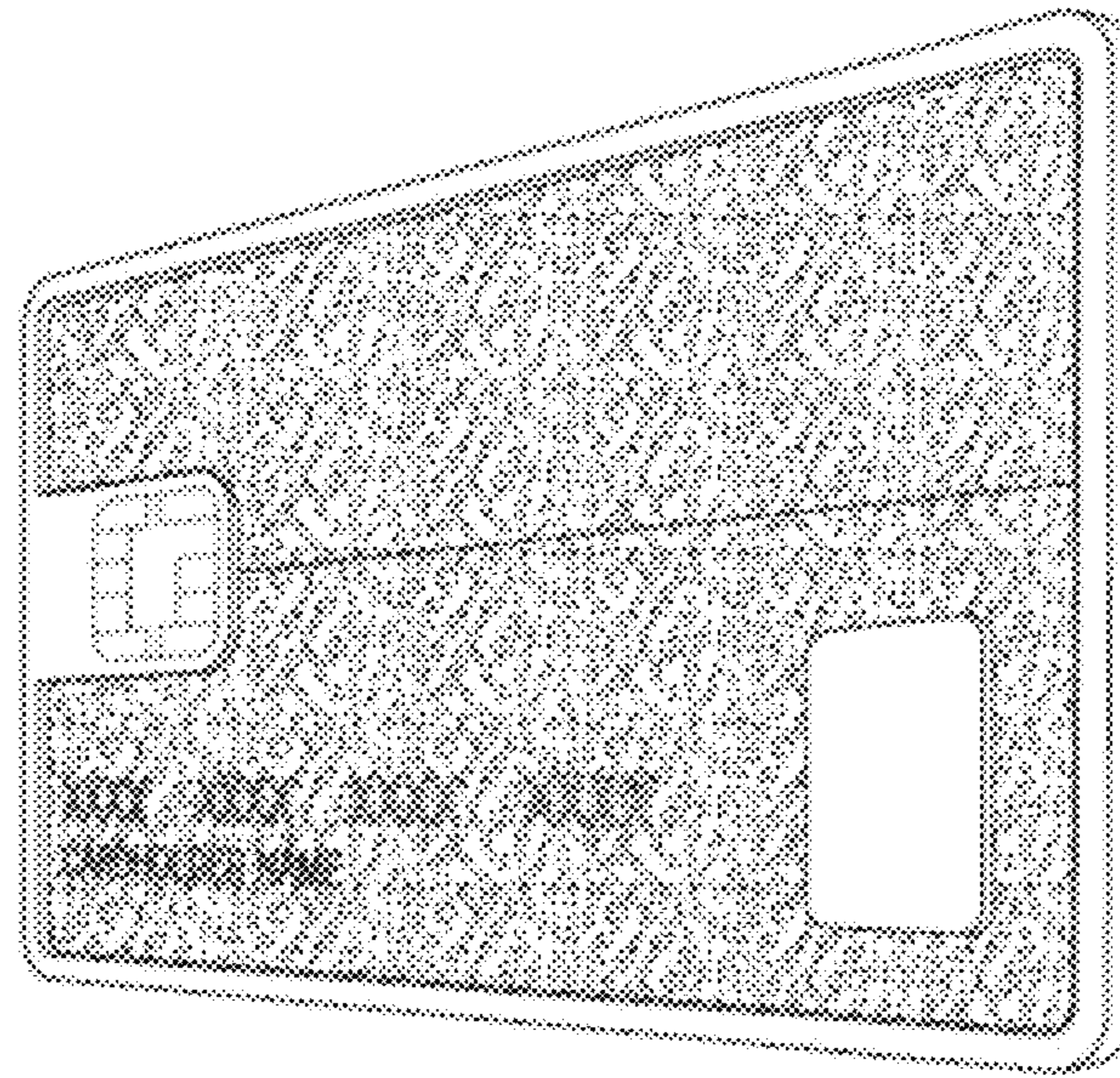

FIG. 51

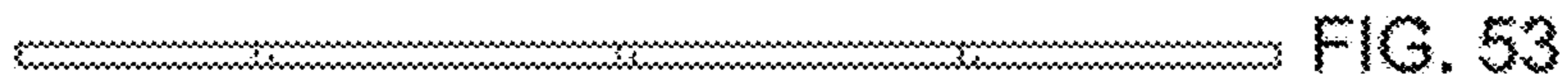

FIG. 53

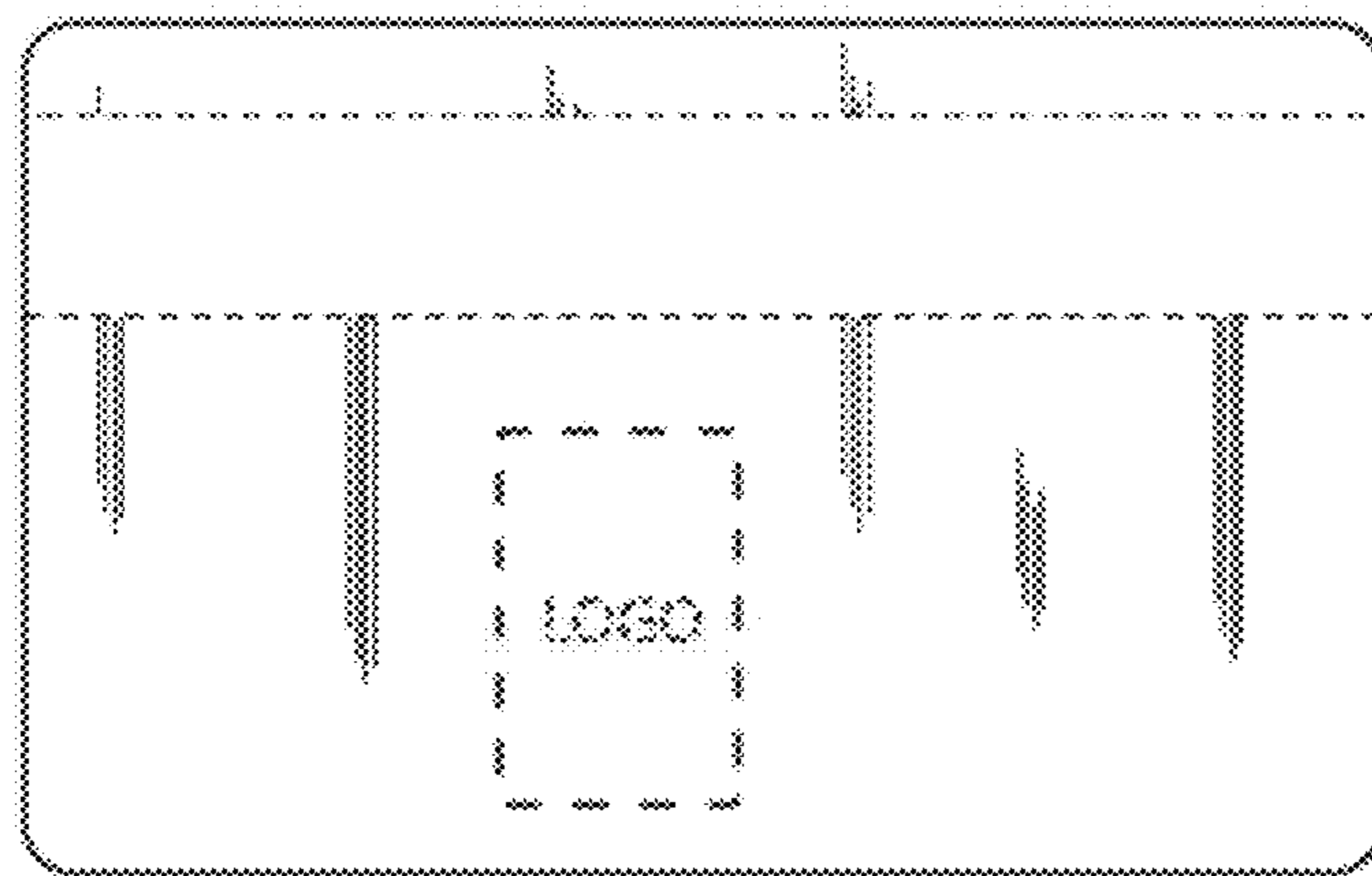

FIG. 52

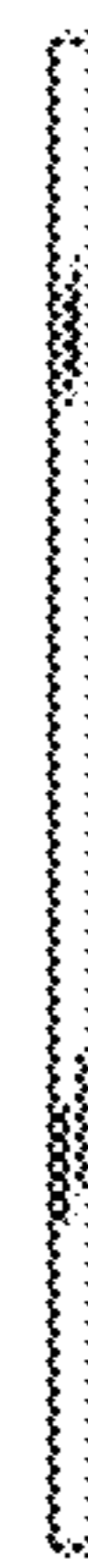

FIG. 54