

US00D672746S

(12) **United States Design Patent**
Birger

(10) **Patent No.:** **US D672,746 S**

(45) **Date of Patent:** **** Dec. 18, 2012**

(54) **HEADSET**

(75) Inventor: **Johan Birger**, Malmö (SE)

(73) Assignee: **GN Netcom A/S** (DK)

(**) Term: **14 Years**

(21) Appl. No.: **29/409,352**

(22) Filed: **Dec. 22, 2011**

(30) **Foreign Application Priority Data**

Jul. 22, 2011 (EM) 001894908-0001

(51) **LOC (9) Cl.** **14-01**

(52) **U.S. Cl.** **D14/206**

(58) **Field of Classification Search** D14/206,

D14/223, 205; 181/129, 130, 135; 379/430,

379/431; 381/380, 381, 374; 455/90.3, 575.2

See application file for complete search history.

(56) **References Cited**

U.S. PATENT DOCUMENTS

| | | | |
|--------------|---------|-----------------|---------|
| D366,486 S * | 1/1996 | Runquist et al. | D14/206 |
| D385,272 S * | 10/1997 | Jensen et al. | D14/142 |
| D403,327 S * | 12/1998 | Landreth et al. | D14/223 |
| D431,235 S * | 9/2000 | Lyman et al. | D14/142 |
| D439,890 S * | 4/2001 | Skulley et al. | D14/223 |
| D443,871 S * | 6/2001 | Hofstede et al. | D14/206 |
| D451,907 S * | 12/2001 | Amae et al. | D14/223 |
| D452,857 S * | 1/2002 | Hong | D14/223 |
| D455,417 S * | 4/2002 | Bey et al. | D14/223 |
| D455,732 S * | 4/2002 | Skulley et al. | D14/223 |
| D461,791 S * | 8/2002 | Ma | D14/206 |
| D462,943 S * | 9/2002 | Lucaci et al. | D14/206 |
| D464,943 S * | 10/2002 | Lai | D14/206 |
| D464,951 S * | 10/2002 | Skulley et al. | D14/223 |

| | | | |
|----------------|---------|----------------|------------|
| D468,728 S * | 1/2003 | Rath et al. | D14/223 |
| D470,835 S * | 2/2003 | Bey et al. | D14/223 |
| D472,231 S * | 3/2003 | Eisenbraun | D14/223 |
| D478,574 S * | 8/2003 | Ming | D14/223 |
| D480,711 S * | 10/2003 | Kuan | D14/223 |
| D485,549 S * | 1/2004 | Ma et al. | D14/223 |
| D487,078 S * | 2/2004 | Chen | D14/223 |
| 6,751,331 B2 * | 6/2004 | Eisenbraun | 381/375 |
| D494,569 S * | 8/2004 | Ma | D14/223 |
| D497,613 S * | 10/2004 | Gwee | D14/223 |
| D512,992 S * | 12/2005 | Murakami | D14/223 |
| D521,987 S * | 5/2006 | Ma et al. | D14/223 |
| 7,106,877 B1 * | 9/2006 | Linville | 381/381 |
| D581,900 S * | 12/2008 | Caddes et al. | D14/206 |
| D598,895 S * | 8/2009 | Bentley et al. | D14/206 |
| D604,718 S * | 11/2009 | Paterson | D14/206 |
| D622,694 S * | 8/2010 | Lascelles | D14/203.3 |
| D634,300 S * | 3/2011 | Yang et al. | D14/206 |
| D635,962 S * | 4/2011 | Kelley | D14/223 |
| D640,232 S * | 6/2011 | Brandis | D14/206 |
| 7,995,746 B2 * | 8/2011 | Rath et al. | 379/433.01 |

* cited by examiner

Primary Examiner — Paula Greene

(74) *Attorney, Agent, or Firm* — Altera Law Group, LLC

(57) **CLAIM**

The ornamental design for a headset, as shown and described.

DESCRIPTION

FIG. 1 is a perspective view of the headset.
FIG. 2 is a front plan view thereof.
FIG. 3 is a rear plan view thereof.
FIG. 4 is a side plan view thereof.
FIG. 5 is the other side plan view thereof.
FIG. 6 is a bottom plan view thereof; and,
FIG. 7 is the top plan view thereof.

1 Claim, 5 Drawing Sheets

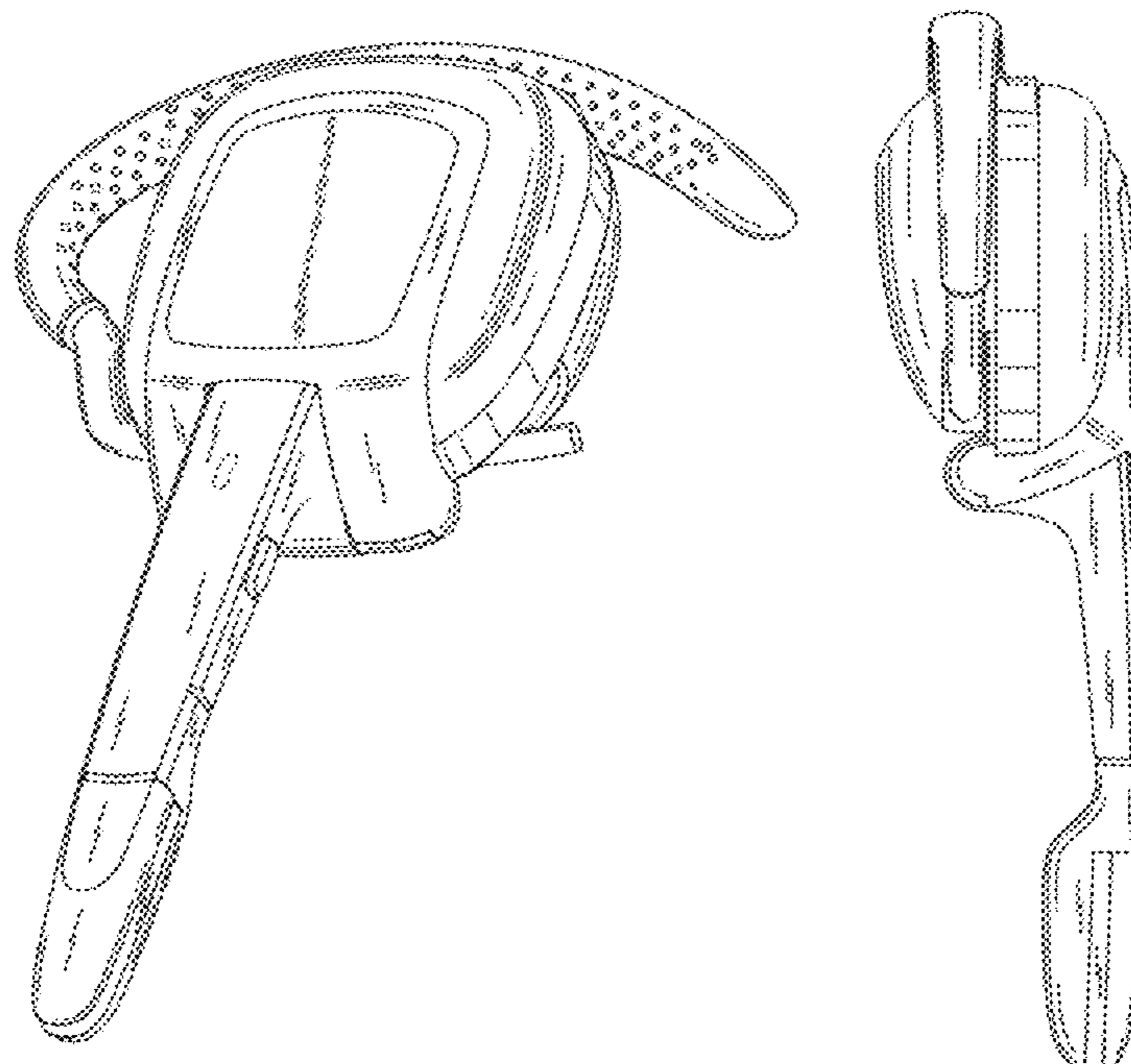



Fig. 1

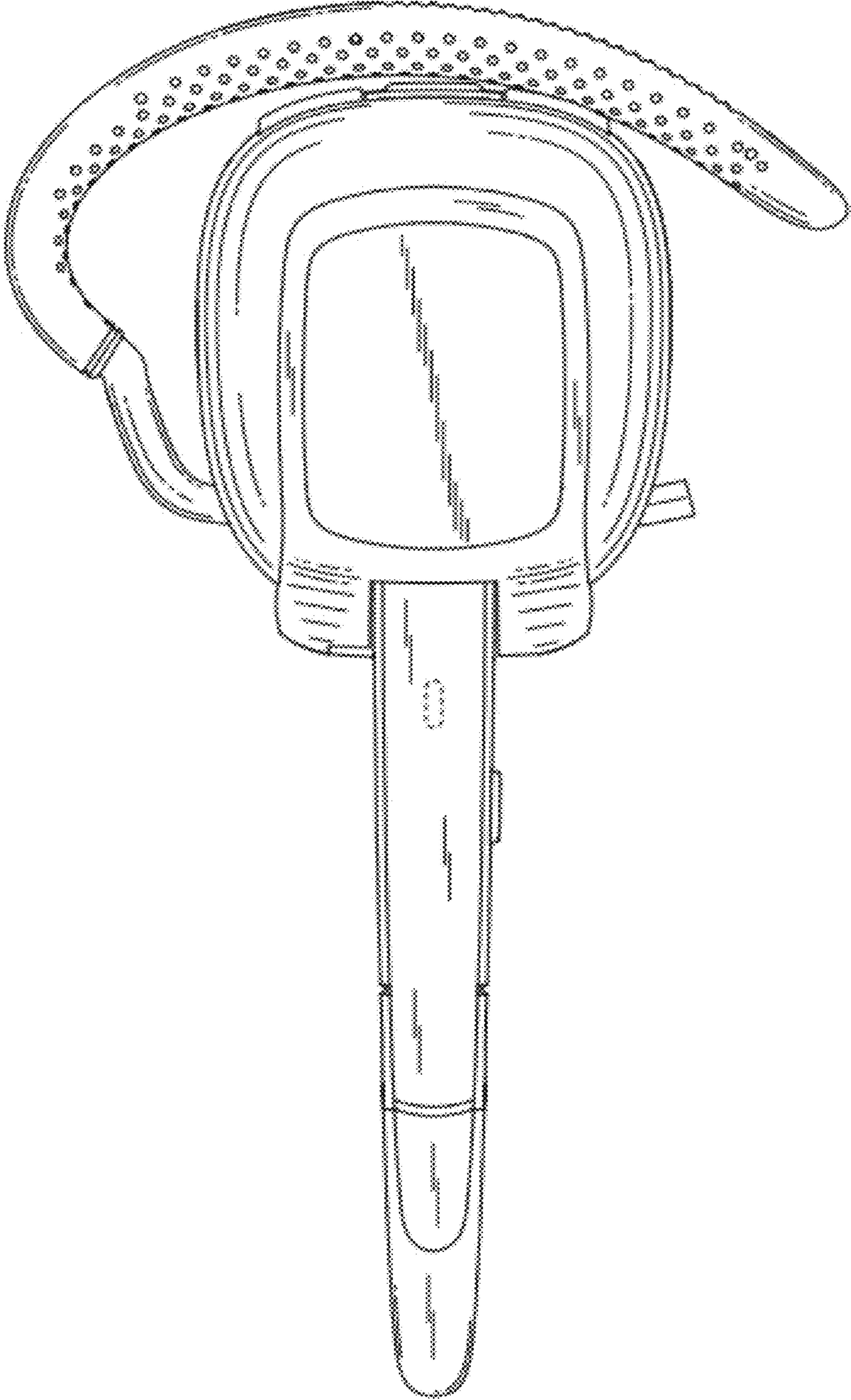

Fig. 2

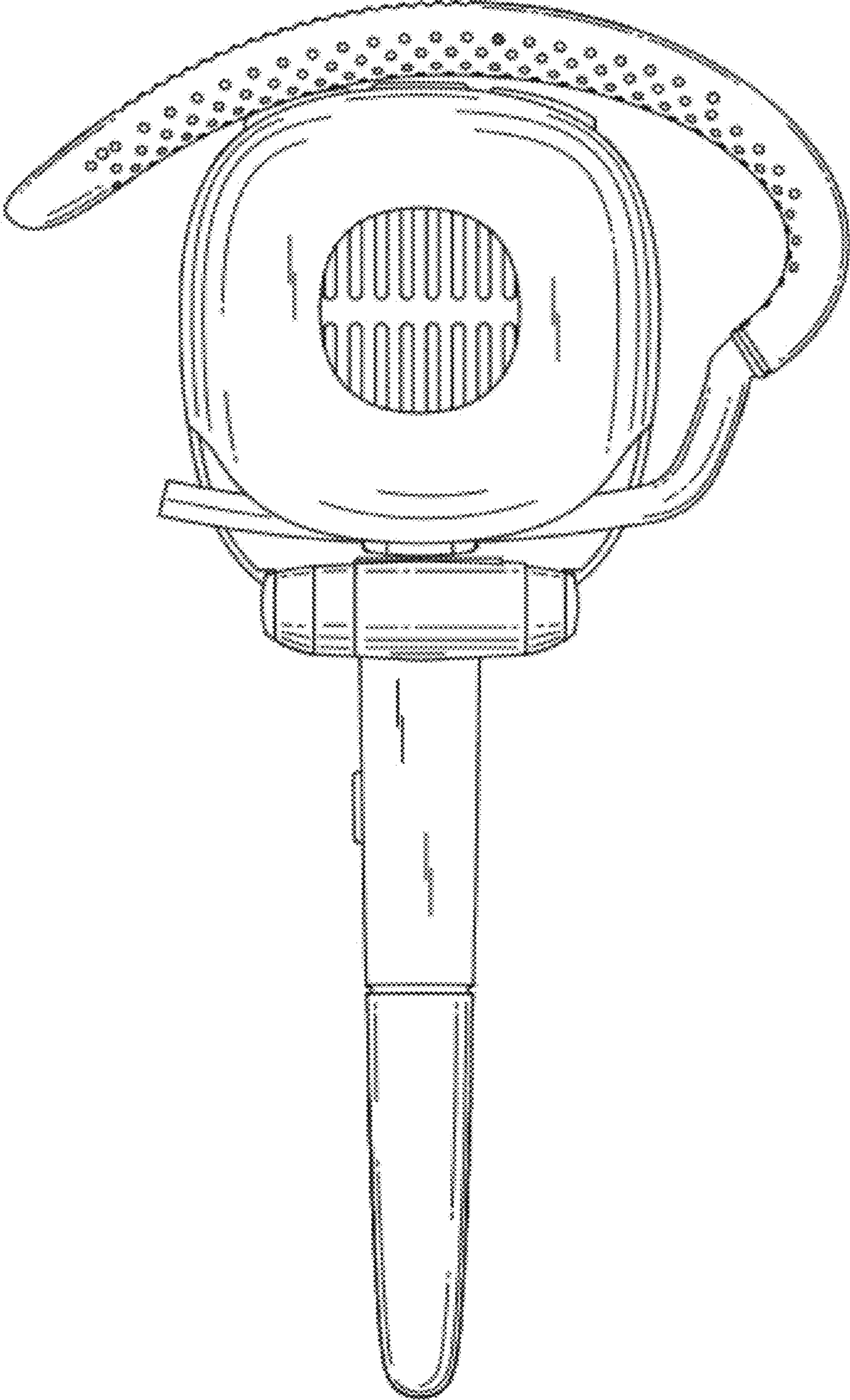

Fig. 3

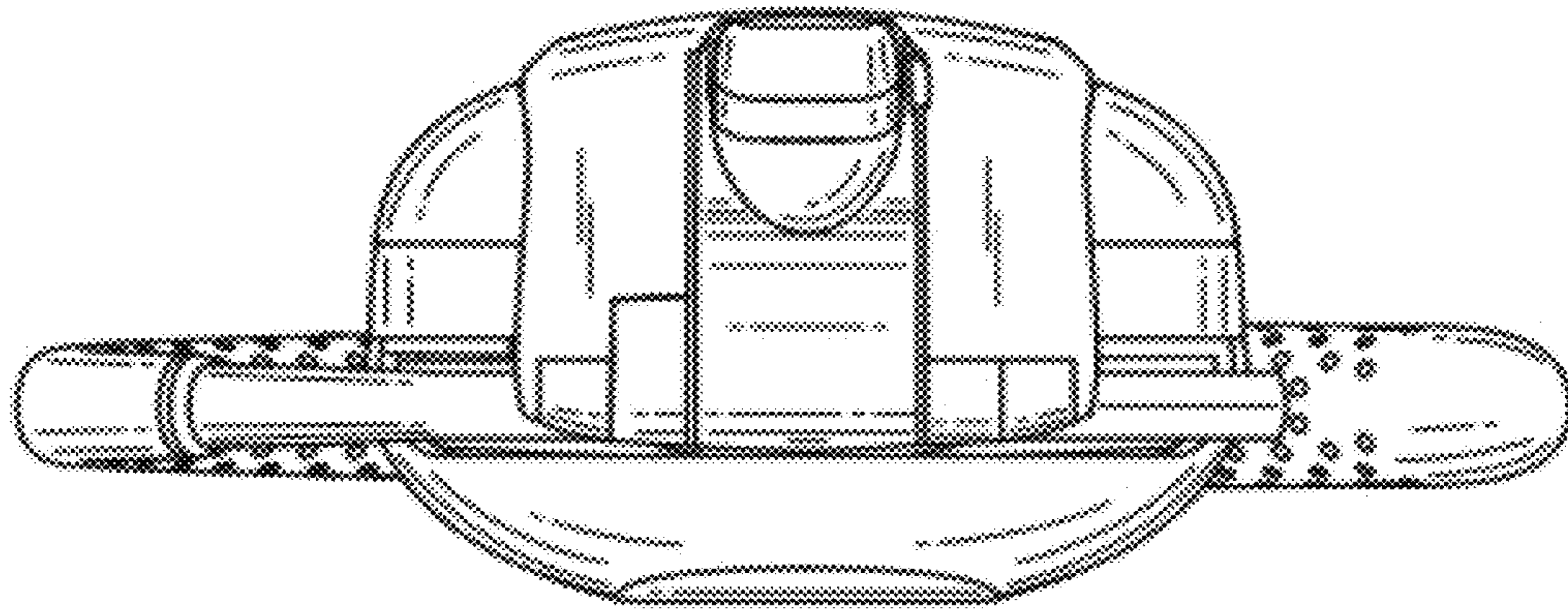

Fig. 4

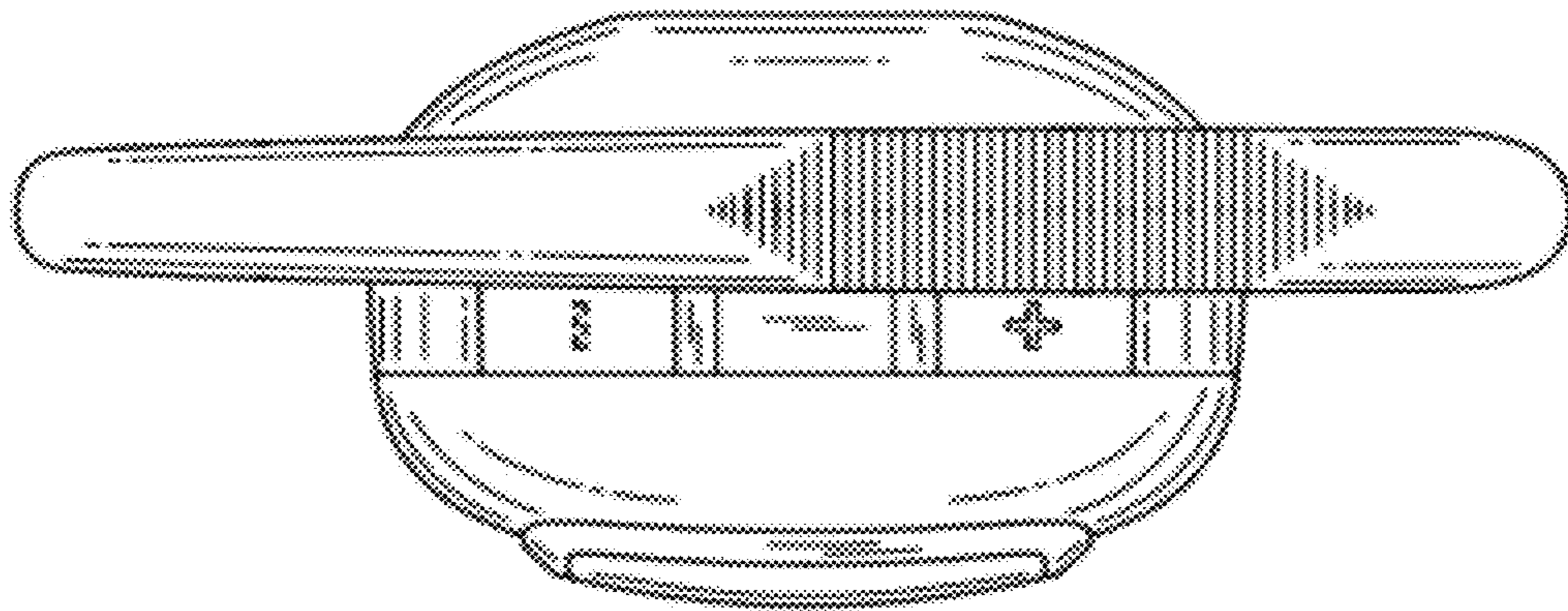

Fig. 5

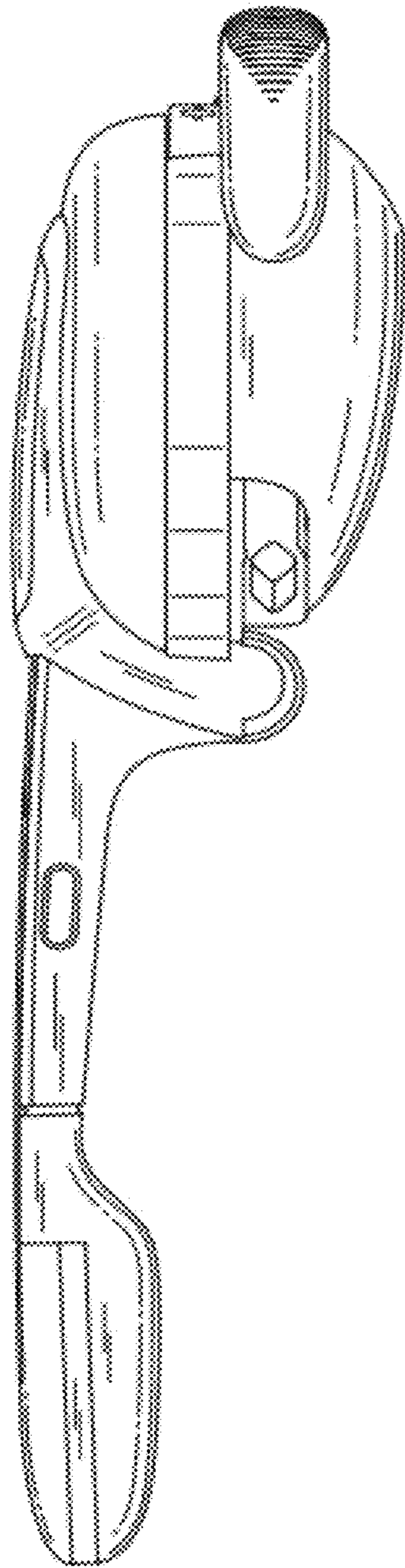

Fig. 6

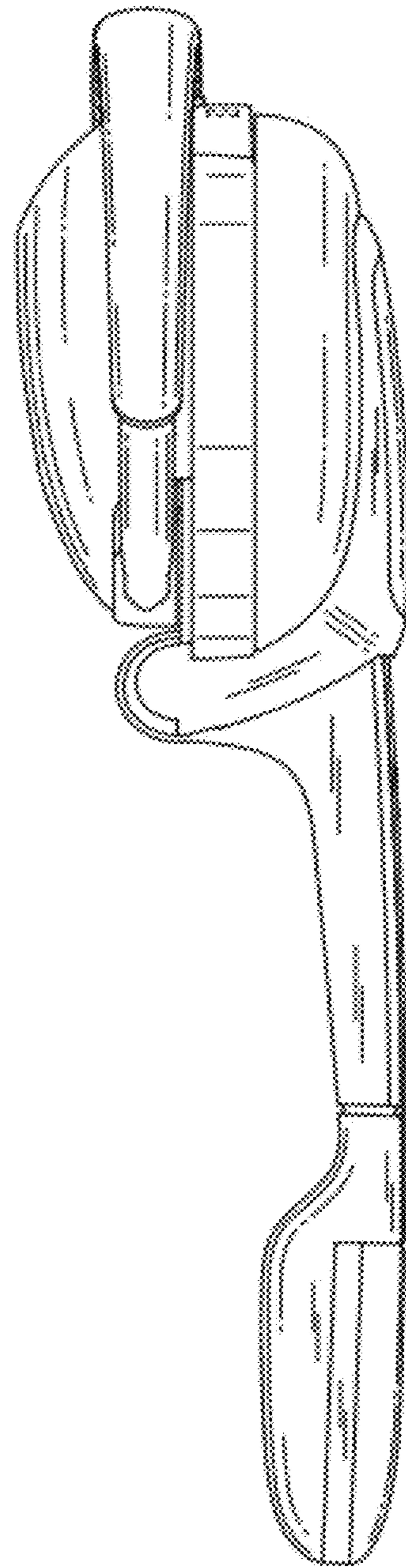

Fig. 7