



US00D672706S

(12) **United States Design Patent**  
**Okumura et al.**

(10) **Patent No.:** **US D672,706 S**

(45) **Date of Patent:** **\*\* Dec. 18, 2012**

(54) **CENTER CONSOLE FOR AUTOMOBILE**

(75) Inventors: **Yuuki Okumura**, Kanagawa (JP); **Ken Okabe**, Kanagawa (JP)

(73) Assignee: **Nissan Motor Co., Ltd.**, Yokohama (JP)

(\*\*) Term: **14 Years**

(21) Appl. No.: **29/411,345**

(22) Filed: **Jan. 19, 2012**

(51) **LOC (9) Cl.** ..... **12-16**

(52) **U.S. Cl.** ..... **D12/415**

(58) **Field of Classification Search** ..... D12/415,  
D12/416, 417, 418, 419, 420; 296/36; 22/539;  
224/404; 248/274.1, 284.1; D8/354; D9/423;  
D14/451-452

See application file for complete search history.

(56) **References Cited**

U.S. PATENT DOCUMENTS

D474,441	S	*	5/2003	Hill et al.	.....	D12/415
6,616,206	B2	*	9/2003	Luginbill et al.	.....	296/37.8
D522,957	S	*	6/2006	Miyashita	.....	D12/424
D530,660	S	*	10/2006	Norman et al.	.....	D12/415
D568,232	S	*	5/2008	Motozaki et al.	.....	D12/421
D571,280	S	*	6/2008	Nakajima et al.	.....	D12/415
D581,861	S	*	12/2008	Anttila et al.	.....	D12/421
D581,862	S	*	12/2008	Anttila et al.	.....	D12/421
D598,362	S	*	8/2009	Tan et al.	.....	D12/415
D624,869	S	*	10/2010	Corradi	.....	D12/415
D632,639	S	*	2/2011	Rosenbohm	.....	D12/415
D656,457	S	*	3/2012	Crepeau	.....	D12/419

\* cited by examiner

Primary Examiner — Katrina A Betton

(74) *Attorney, Agent, or Firm* — Global IP Counselors, LLP

(57) **CLAIM**

The ornamental design for a center console for an automobile, as shown and described.

**DESCRIPTION**

FIG. 1 is a front elevational view of a center console for an automobile in accordance with our new design;

FIG. 2 is a rear elevational view of the center console in accordance with our new design of FIG. 1;

FIG. 3 is a top plan view of the center console in accordance with our new design of FIGS. 1 and 2;

FIG. 4 is a left side elevational view of the center console in accordance with our new design of FIGS. 1 to 3;

FIG. 5 is a right side elevational view of the center console in accordance with our new design of FIGS. 1 to 4;

FIG. 6 is a front, left and top side perspective view of the center console in accordance with our new design of FIGS. 1 to 5;

FIG. 7 is a rear, right and top side perspective view of the center console in accordance with our new design of FIGS. 1 to 6; and,

FIG. 8 is a cross sectional view of the center console in accordance with our new design of FIGS. 1 to 7 as taken along a section line 8-8 in FIG. 4.

The bottom view of the center console forms no part of the claimed design.

The broken line showing of the center console is for purpose of illustrating environmental structure and forms no part of the claimed design.

The cross sectional view of FIG. 8 is provided to clarify the exact contour or configuration of the exterior surface of the center console, and no attempt is made to illustrate features of internal construction.

Our new design includes the mirror image of the center console shown in FIGS. 1 to 8.

**1 Claim, 8 Drawing Sheets**

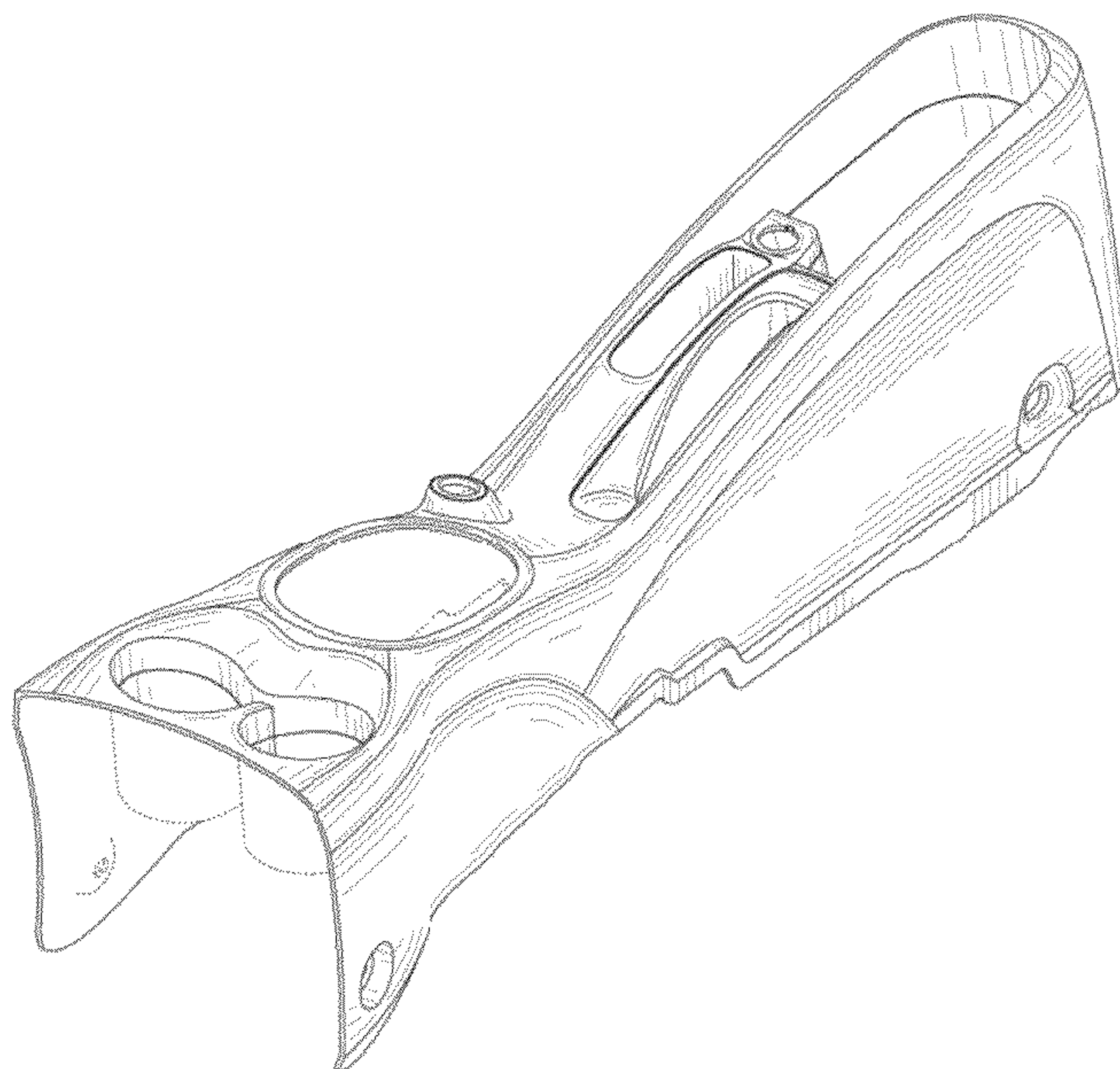

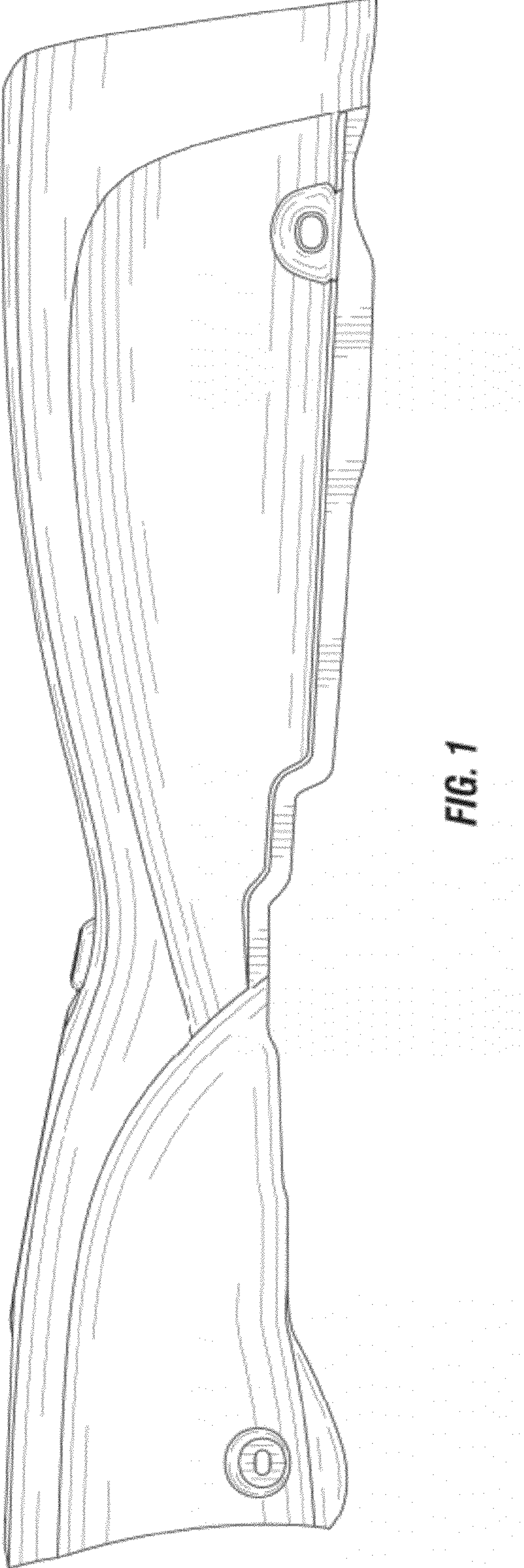

FIG. 1



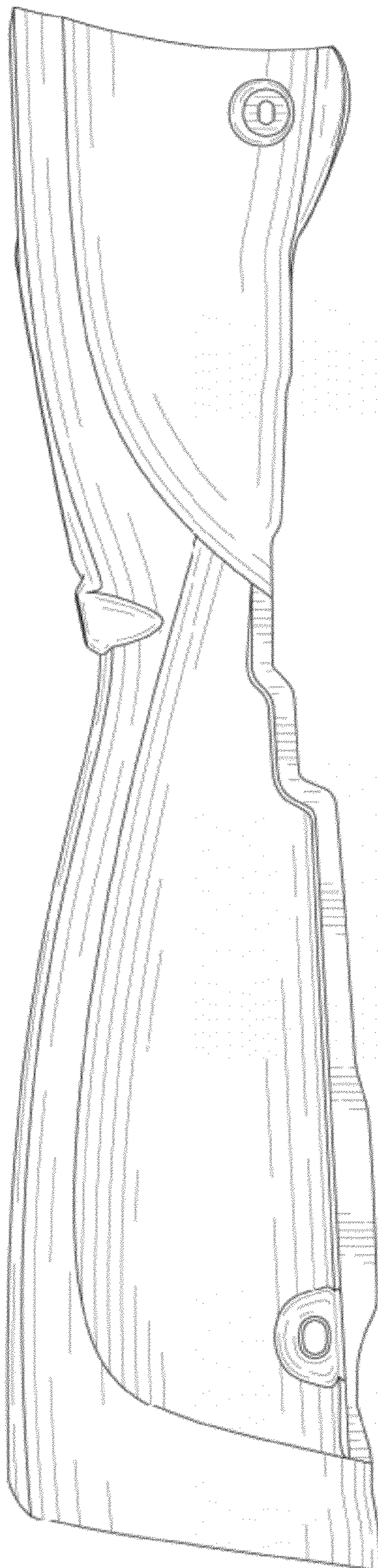

FIG. 2

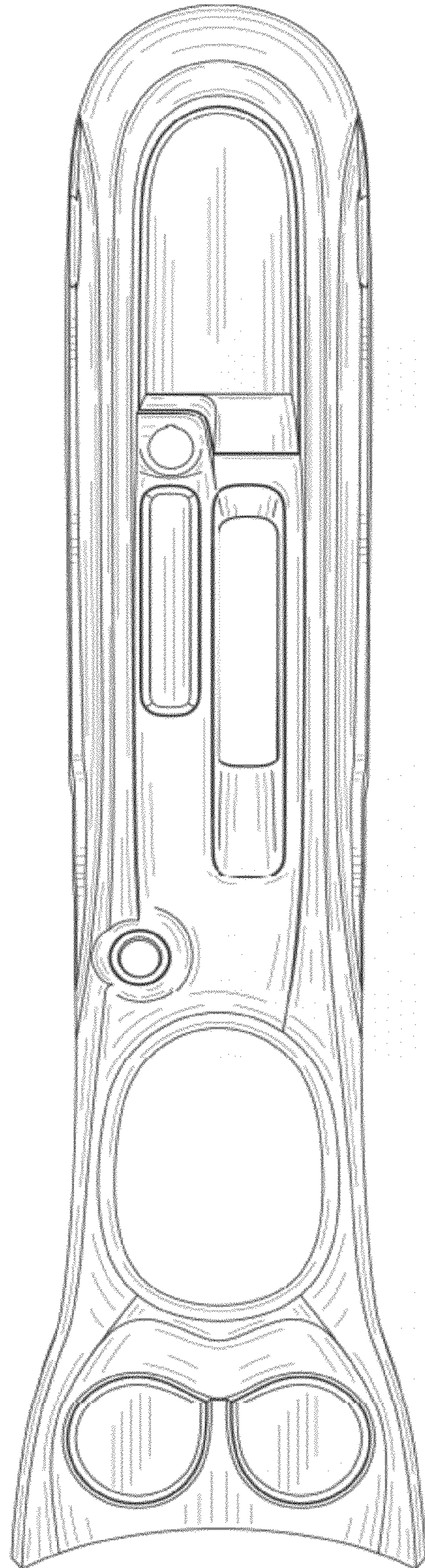
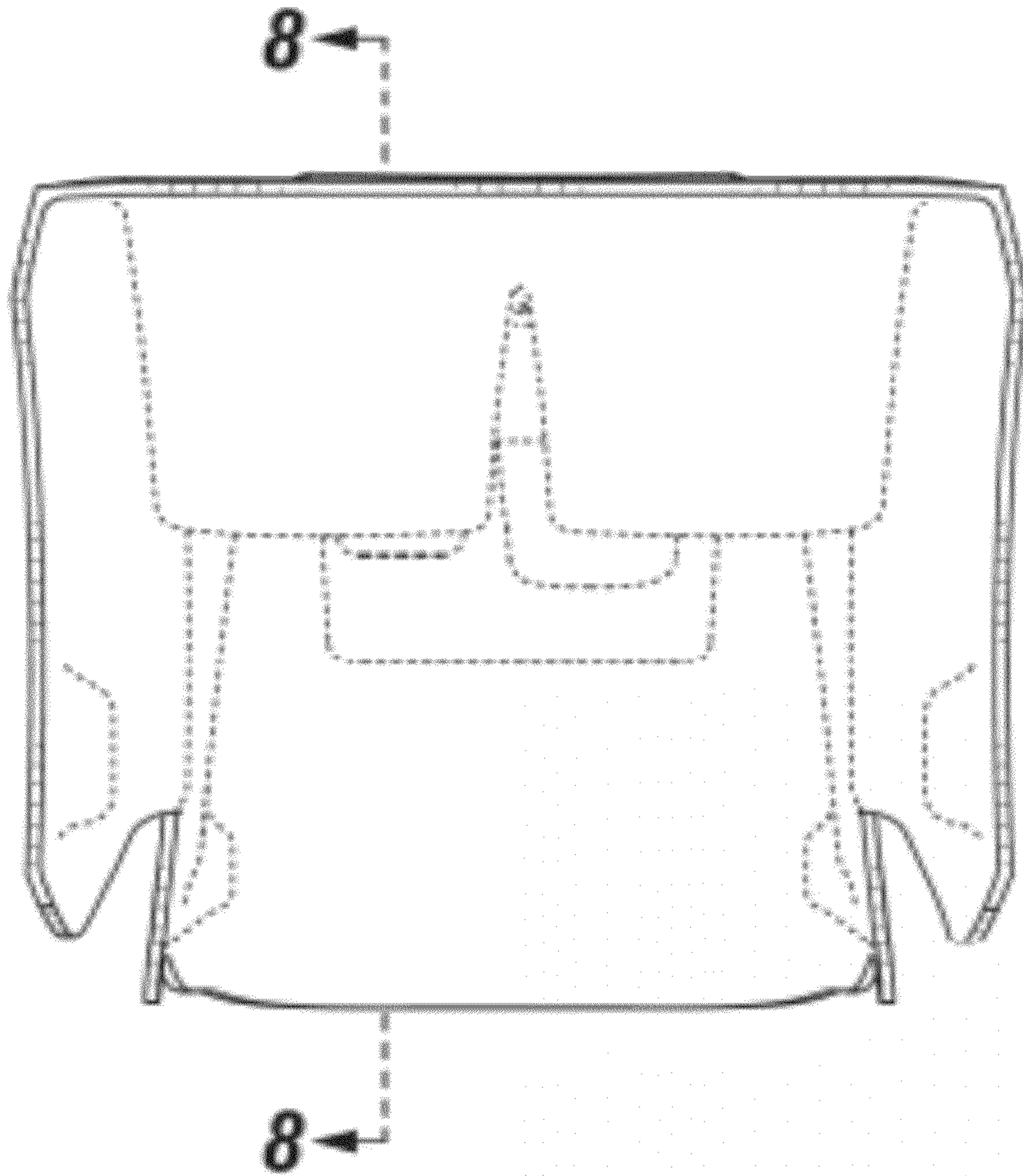
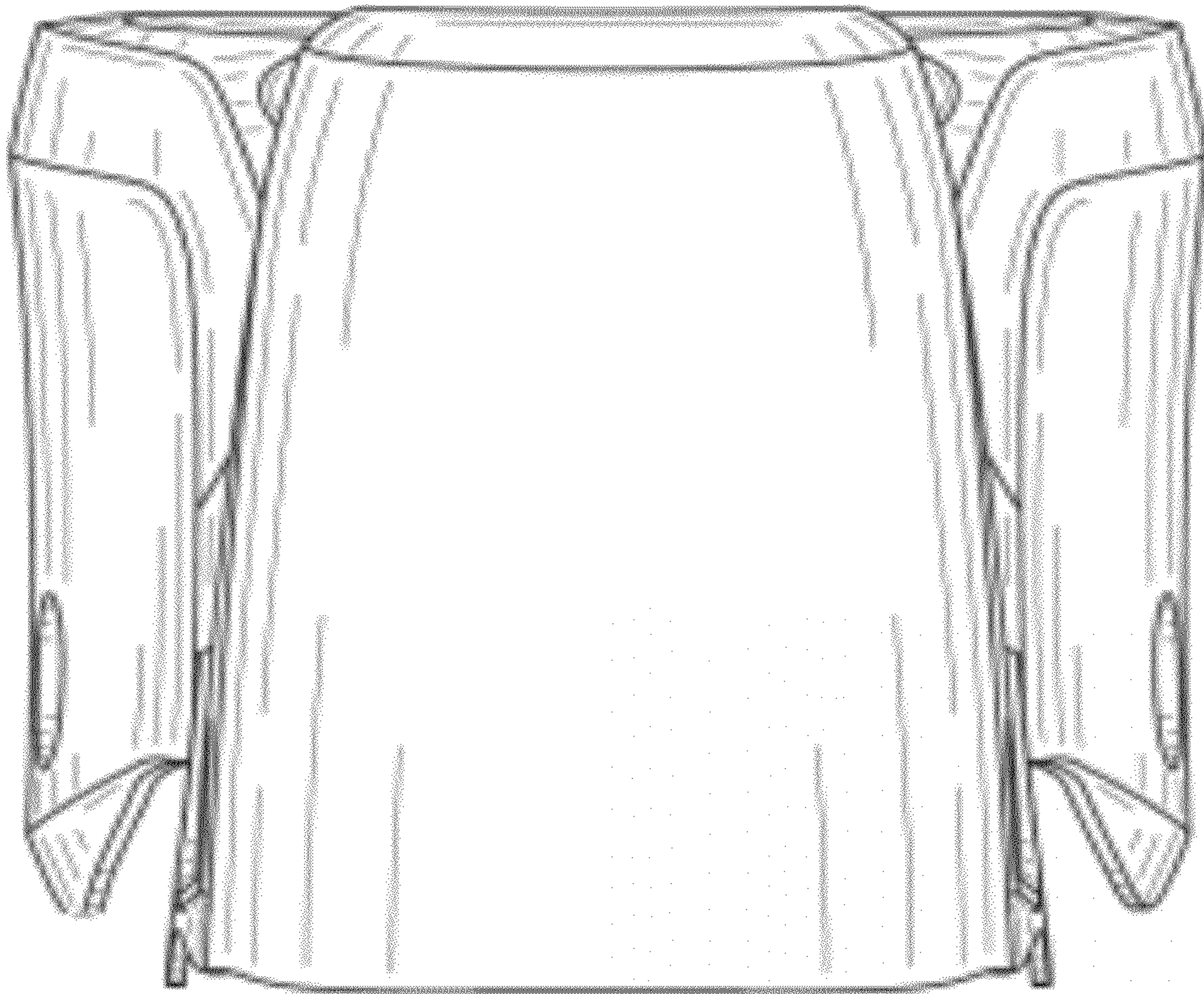

FIG. 3





**FIG. 4**



**FIG. 5**



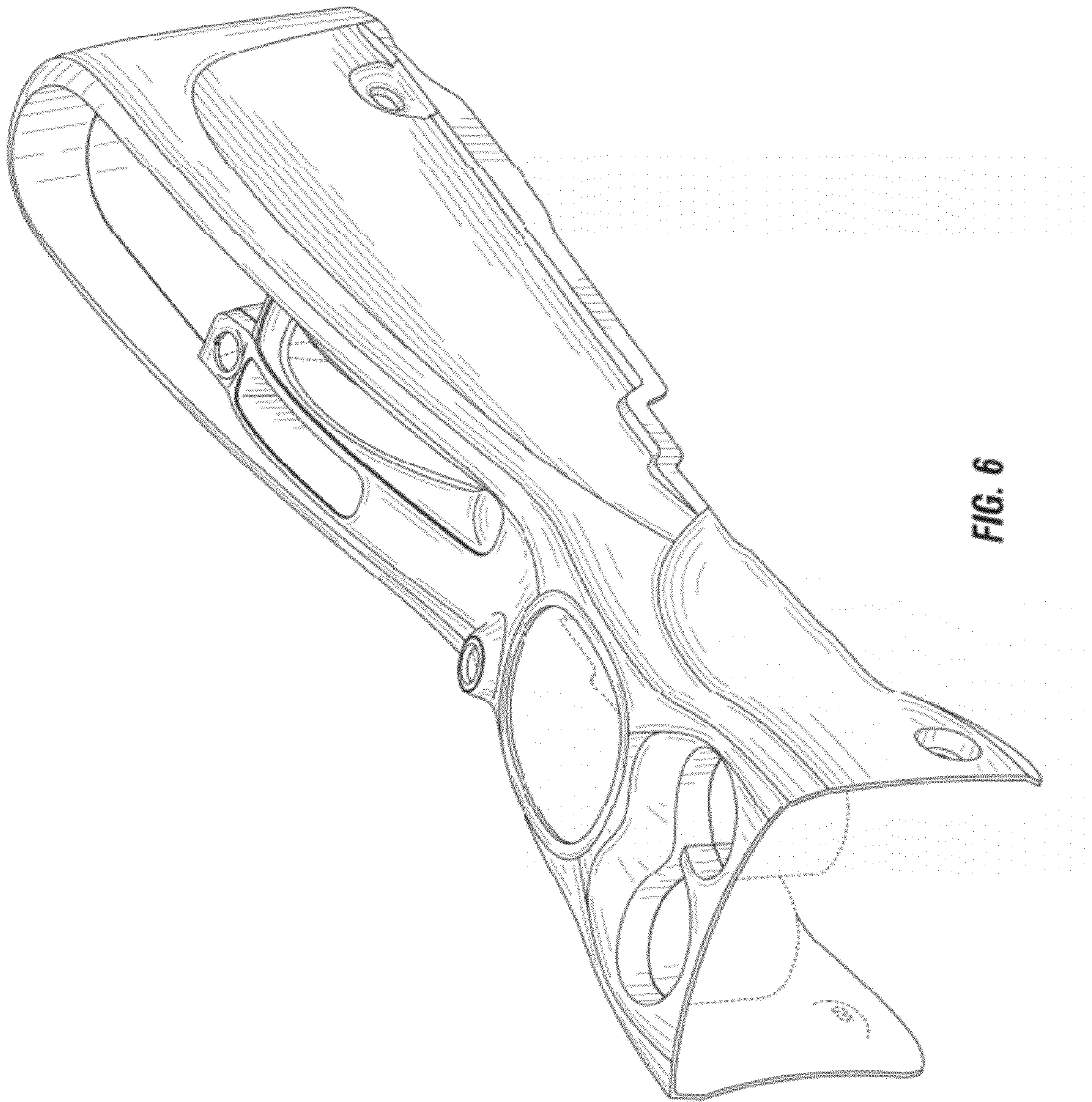

FIG. 6

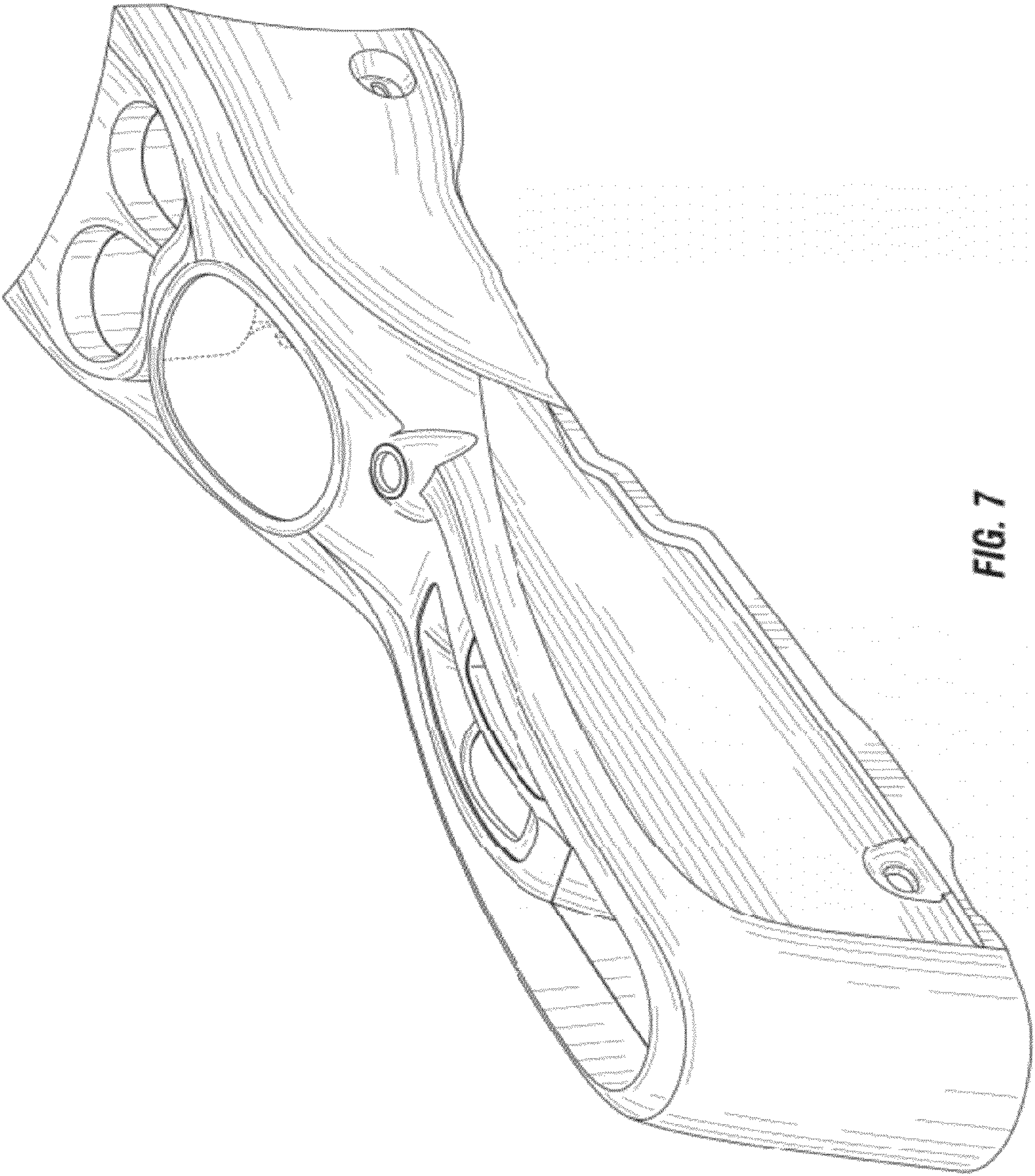

FIG. 7



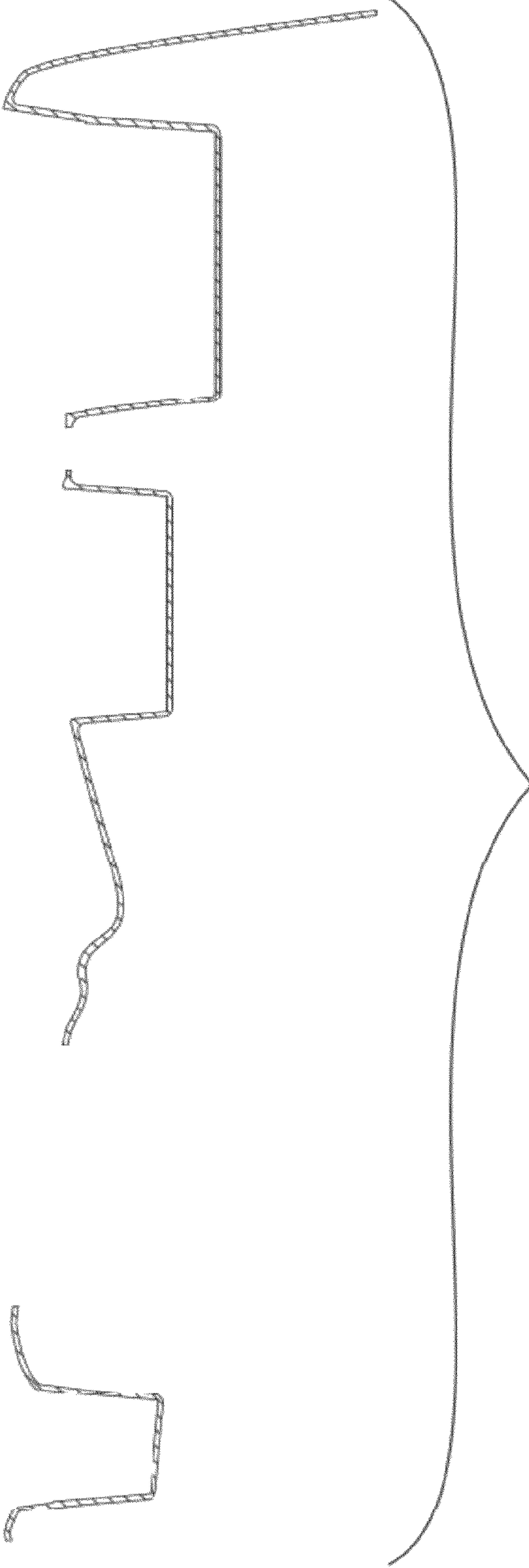

FIG. 8