



US00D672687S

(12) **United States Design Patent**  
**Himi**

(10) **Patent No.:** **US D672,687 S**

(45) **Date of Patent:** **\*\* Dec. 18, 2012**

(54) **CHAIN FOR A SLIDE FASTENER**

(75) Inventor: **Naoyuki Himi**, Cheshire (GB)

(73) Assignee: **YKK Corporation** (JP)

(\*\*) Term: **14 Years**

(21) Appl. No.: **29/412,853**

(22) Filed: **Feb. 8, 2012**

(30) **Foreign Application Priority Data**

Oct. 11, 2011 (CN) ..... 2011 3 0358959

(51) **LOC (9) Cl.** ..... **02-07**

(52) **U.S. Cl.** ..... **D11/221**

(58) **Field of Classification Search** ..... D11/200,  
D11/201, 221; 24/381-383, 385-387, 414-417,  
24/421-422, 427-431, 433, 403, 410; 2/265  
See application file for complete search history.

(56) **References Cited**

**U.S. PATENT DOCUMENTS**

2,526,600 A 10/1950 Bolton  
2,660,774 A \* 12/1953 Heimann et al. .... 24/412  
2,862,272 A 12/1958 Morin  
D252,896 S \* 9/1979 Jovin ..... D11/221

**FOREIGN PATENT DOCUMENTS**

WO 2010/082291 A1 7/2010  
WO 2011/023956 A2 3/2011

\* cited by examiner

*Primary Examiner* — Ralf Seifert

(74) *Attorney, Agent, or Firm* — Kilpatrick Townsend & Stockton LLP

(57) **CLAIM**

The ornamental design for a chain for a slide fastener, as shown and described.

**DESCRIPTION**

FIG. 1 is a perspective view of the top, front and right side of a chain for a slider fastener showing my (our) new design; FIG. 2 is a front view thereof; FIG. 3 is a rear view thereof; FIG. 4 is a left side view thereof; FIG. 5 is a right side view thereof; FIG. 6 is a top plan view thereof; and, FIG. 7 is a bottom view thereof.

**1 Claim, 5 Drawing Sheets**

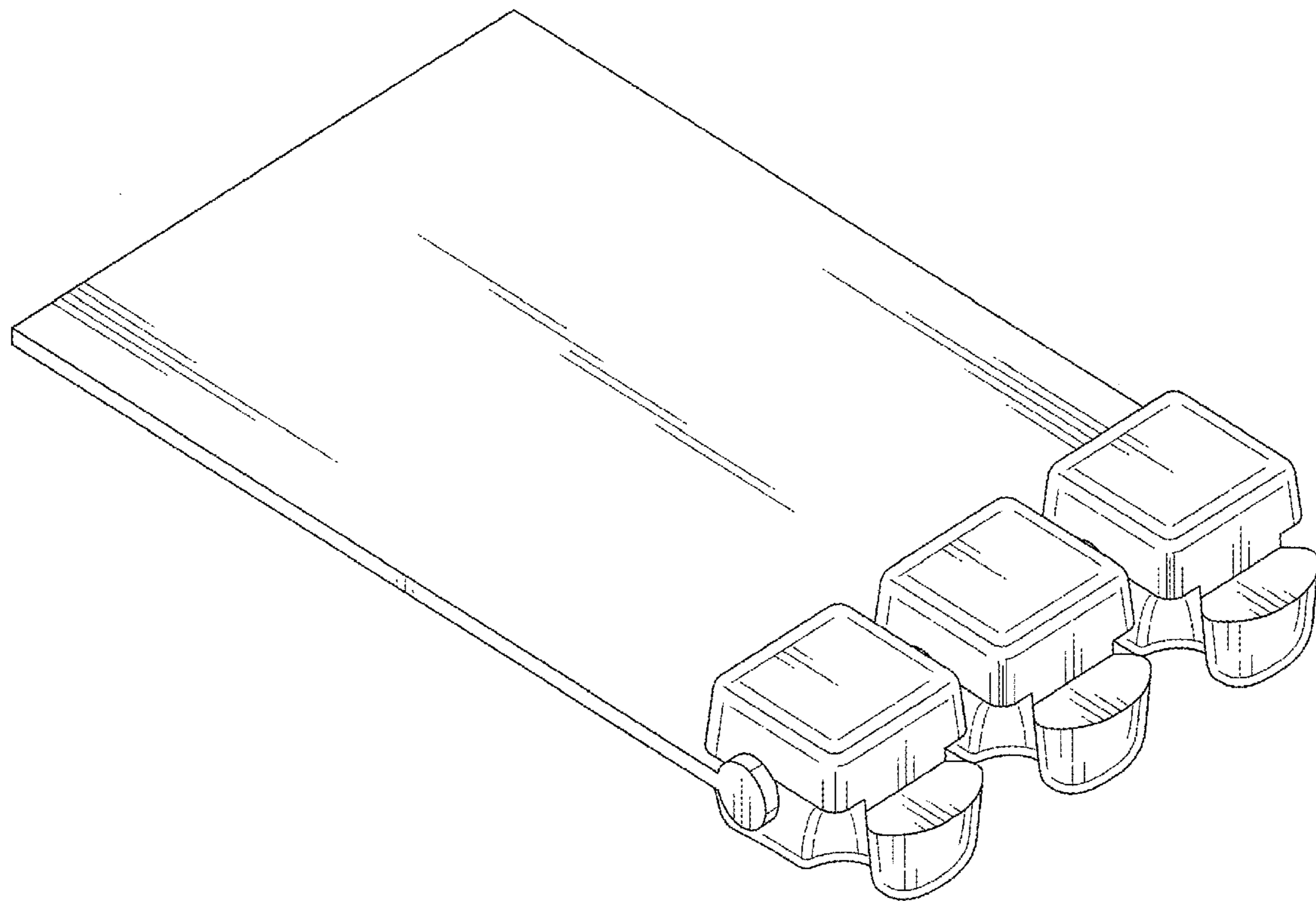

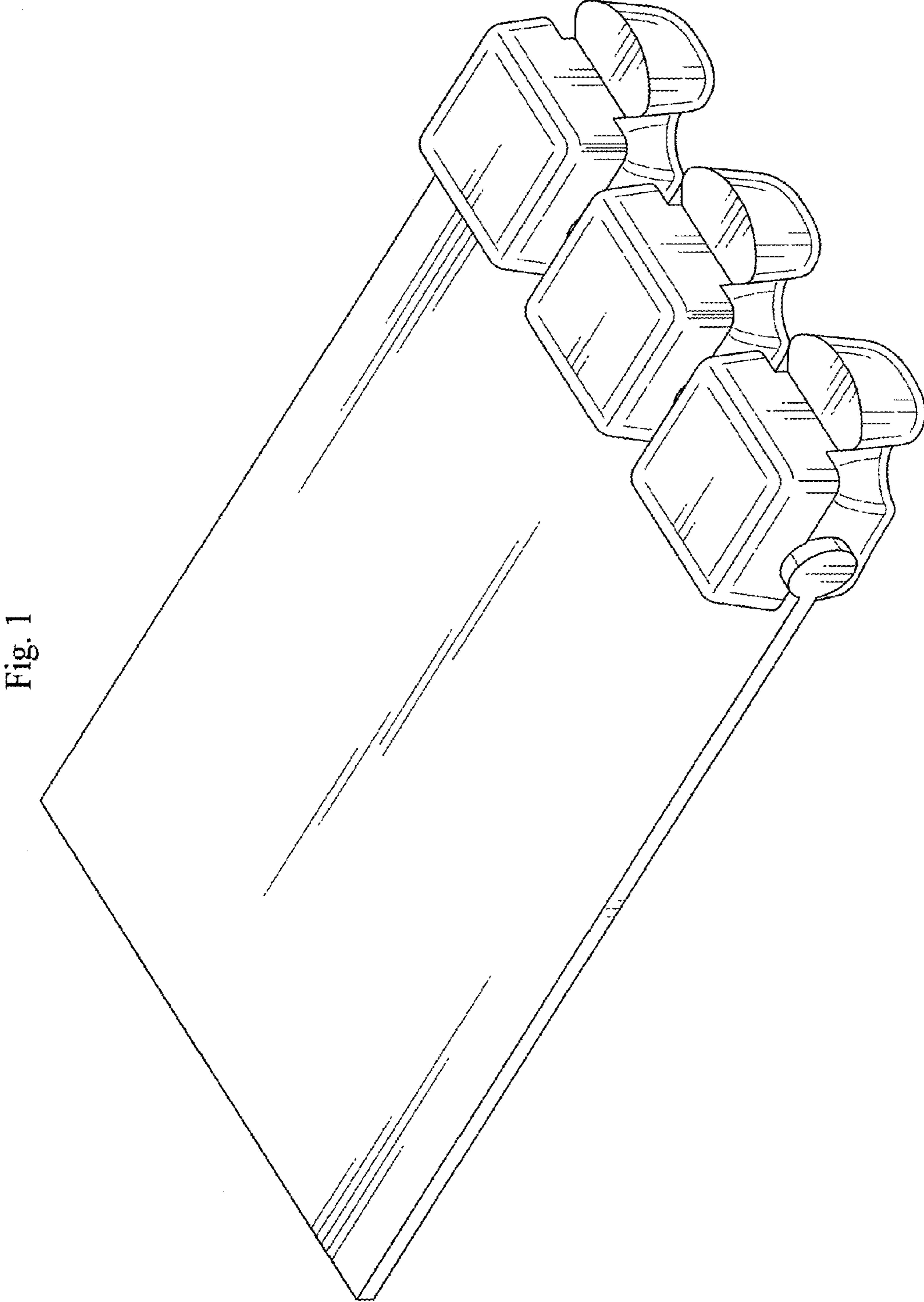

Fig. 1

Fig. 2

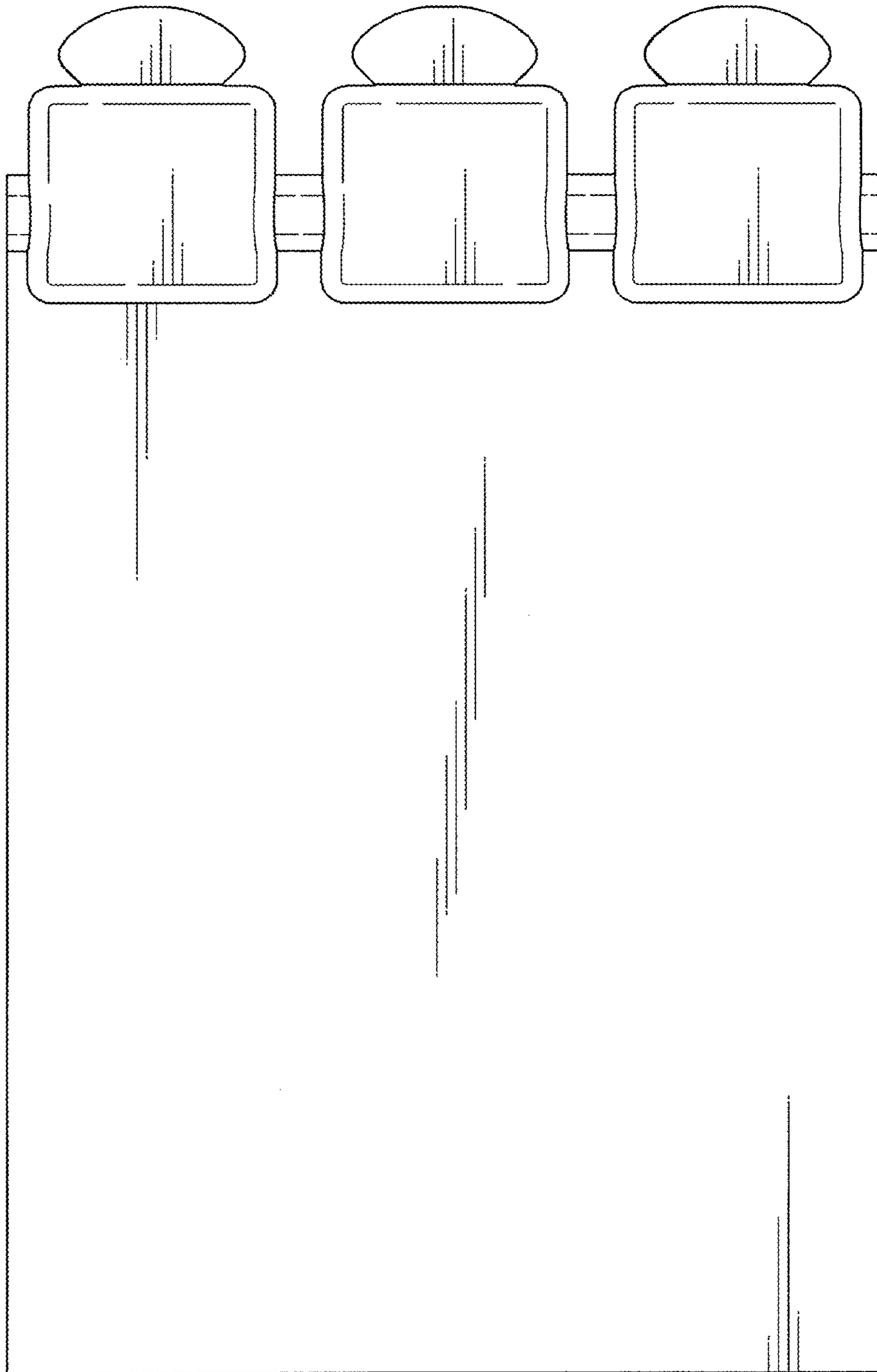

Fig. 3

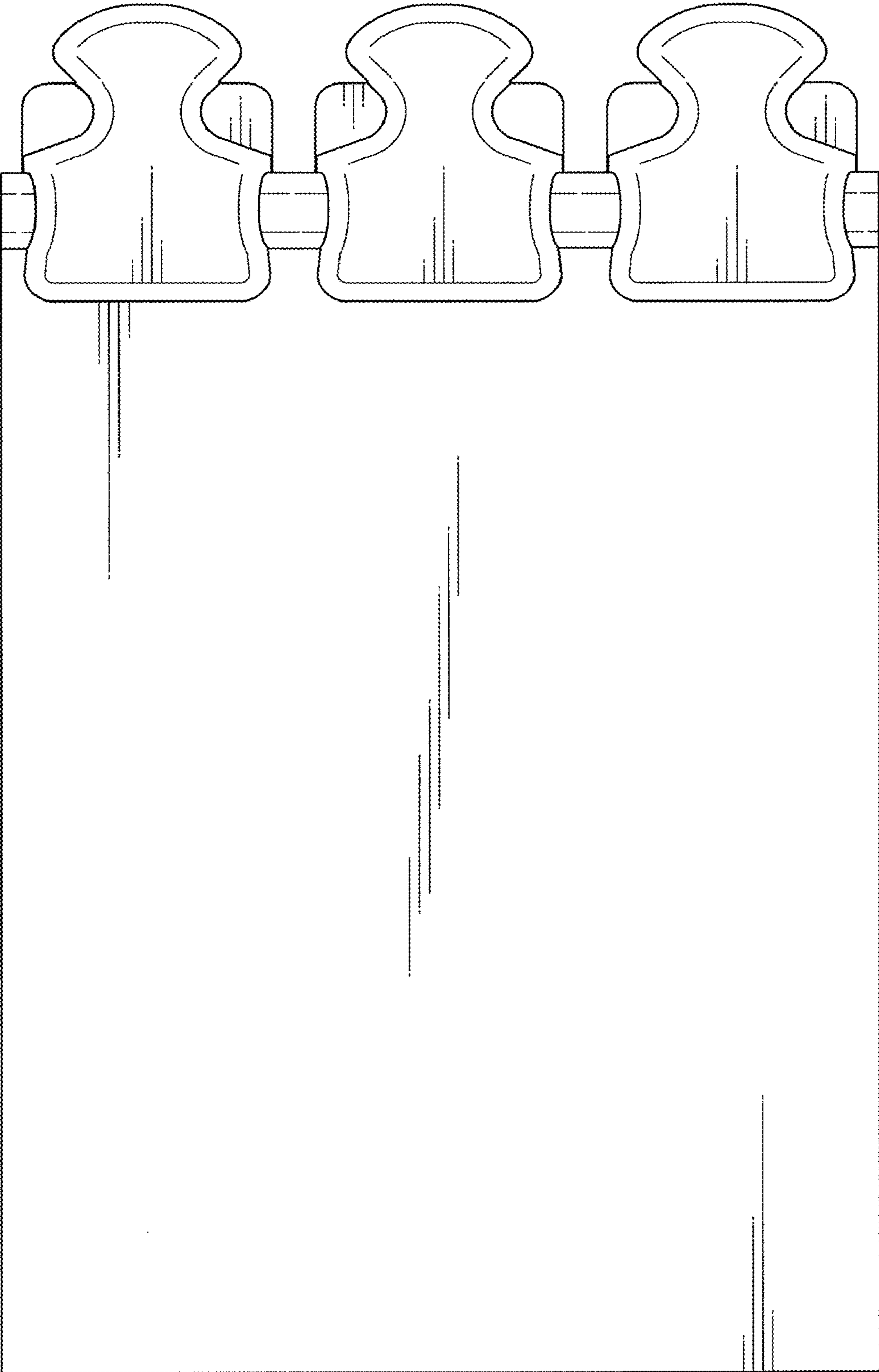

Fig. 4

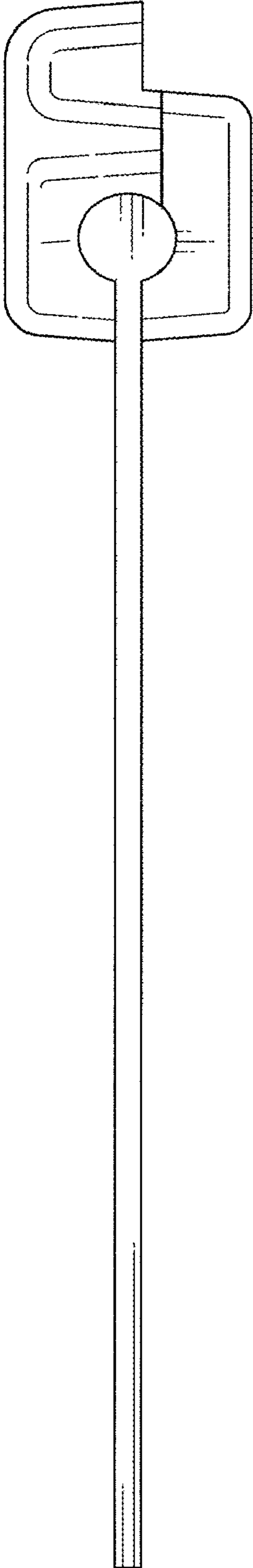

Fig. 5

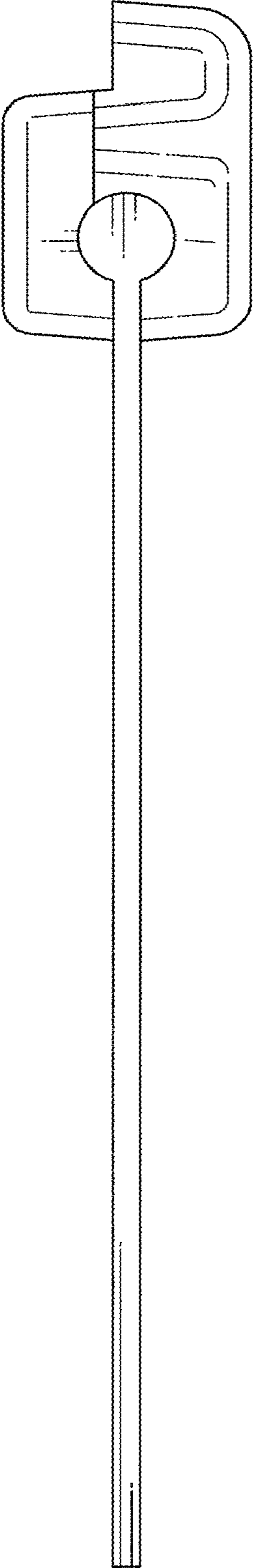

Fig. 6

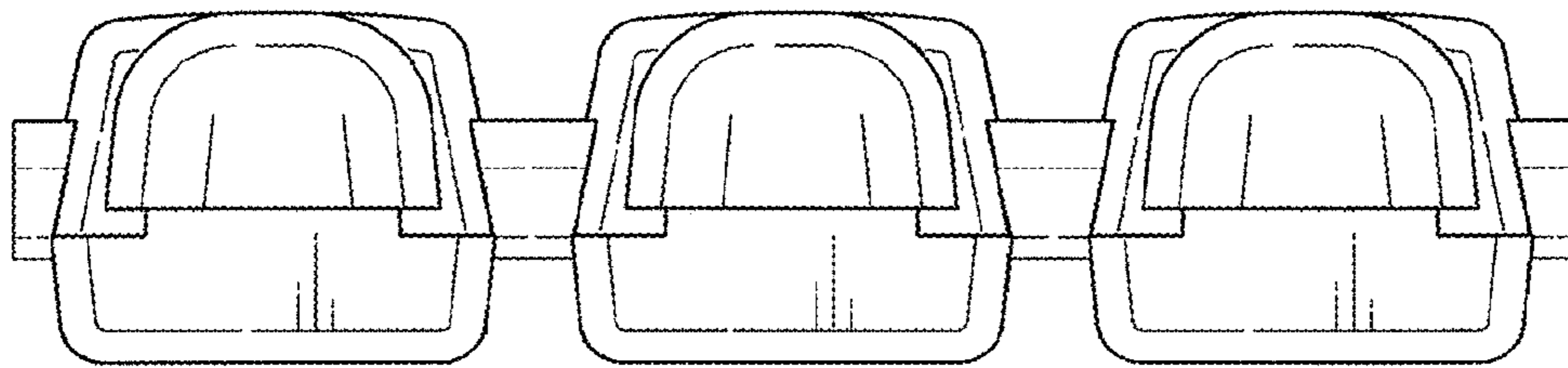

Fig. 7

