



US00D672617S

(12) **United States Design Patent**
Stamper et al.

(10) **Patent No.:** **US D672,617 S**

(45) **Date of Patent:** **** Dec. 18, 2012**

(54) **THREAD TOP CONTAINER**

(75) Inventors: **Leonard R. Stamper**, Anaheim Hills, CA (US); **Brian Sykes**, Mission Viejo, CA (US)

(73) Assignee: **Shye Worldwide, LLC, (CA Ltd Liability Co.)**, Tustin, CA (US)

(**) Term: **14 Years**

(21) Appl. No.: **29/402,991**

(22) Filed: **Sep. 30, 2011**

(51) **LOC (9) Cl.** **07-07**

(52) **U.S. Cl.** **D7/602**

(58) **Field of Classification Search** D7/601, D7/602, 629, 630, 538-542, 612-615; 220/708-802, 220/675, 574-575, 236, 324, 326, 4.23-4.25, 220/735, 23.83, 23.87, 771; D9/529, 549, D9/558, 537, 424, 428, 429

See application file for complete search history.

(56) **References Cited**

U.S. PATENT DOCUMENTS

5,310,074 A * 5/1994 Jochem et al. 220/296
5,356,026 A * 10/1994 Andress et al. 220/792
5,634,569 A * 6/1997 DeCoster 220/735

D508,187 S * 8/2005 Dais et al. D7/602
D508,188 S * 8/2005 Zettle et al. D7/629
D514,390 S * 2/2006 Palder D7/602
D522,319 S * 6/2006 Palder D7/602
D527,588 S * 9/2006 de Groote et al. D7/693
D542,591 S * 5/2007 Carlson D7/354
D601,857 S * 10/2009 Carlson D7/602

* cited by examiner

Primary Examiner — Terry Wallace

(74) *Attorney, Agent, or Firm* — Curtis L. Harrington; Harrington & Harrington

(57) **CLAIM**

The ornamental design for a thread top container, as shown and described.

DESCRIPTION

FIG. 1 is a perspective view of a thread top container; FIG. 2 is a front view, FIG. 3 is a rear view, FIG. 4 is a left side view; FIG. 5 is a right side view; FIG. 6 is a top view; and, FIG. 7 is a bottom view.

1 Claim, 1 Drawing Sheet

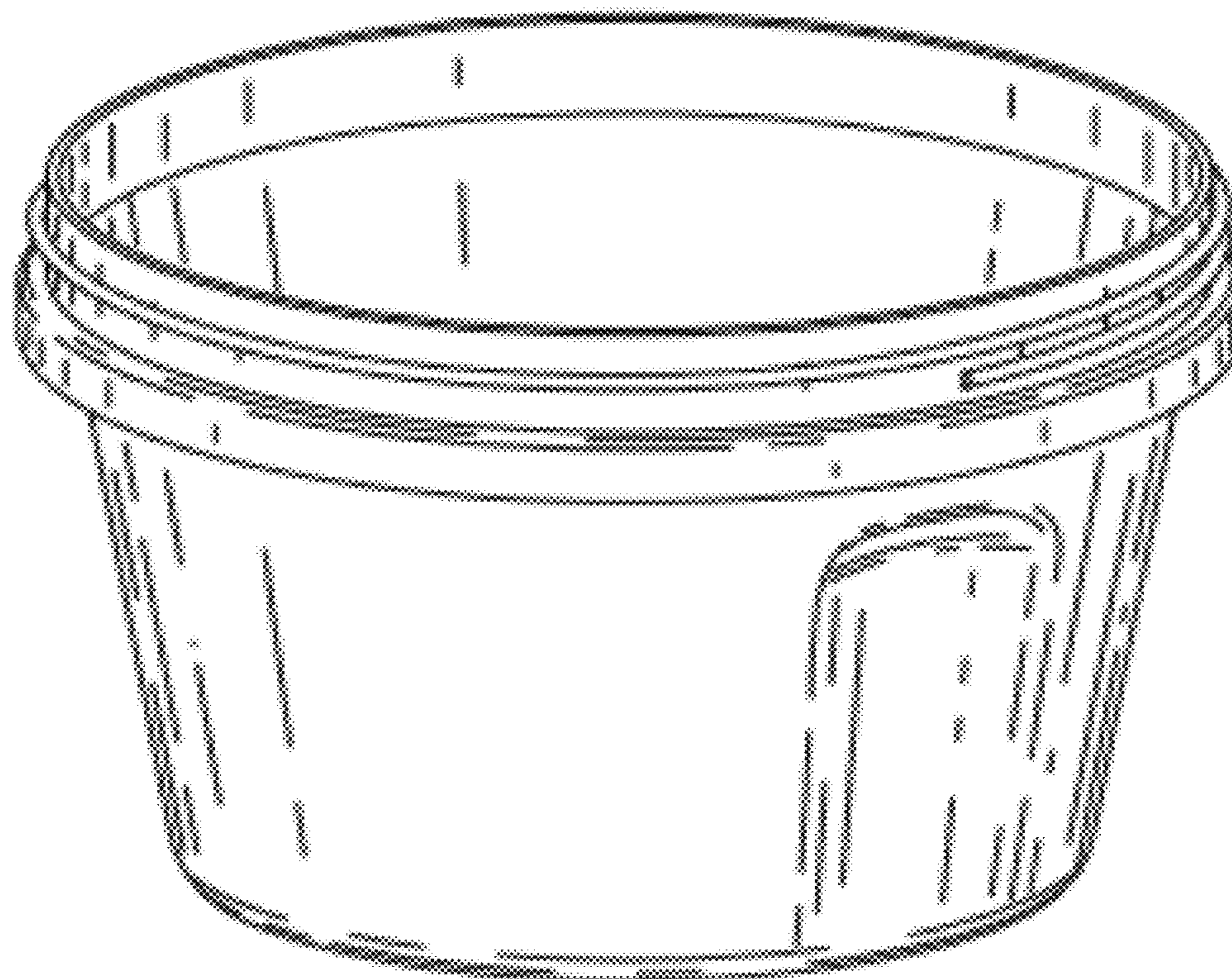

Fig. 1

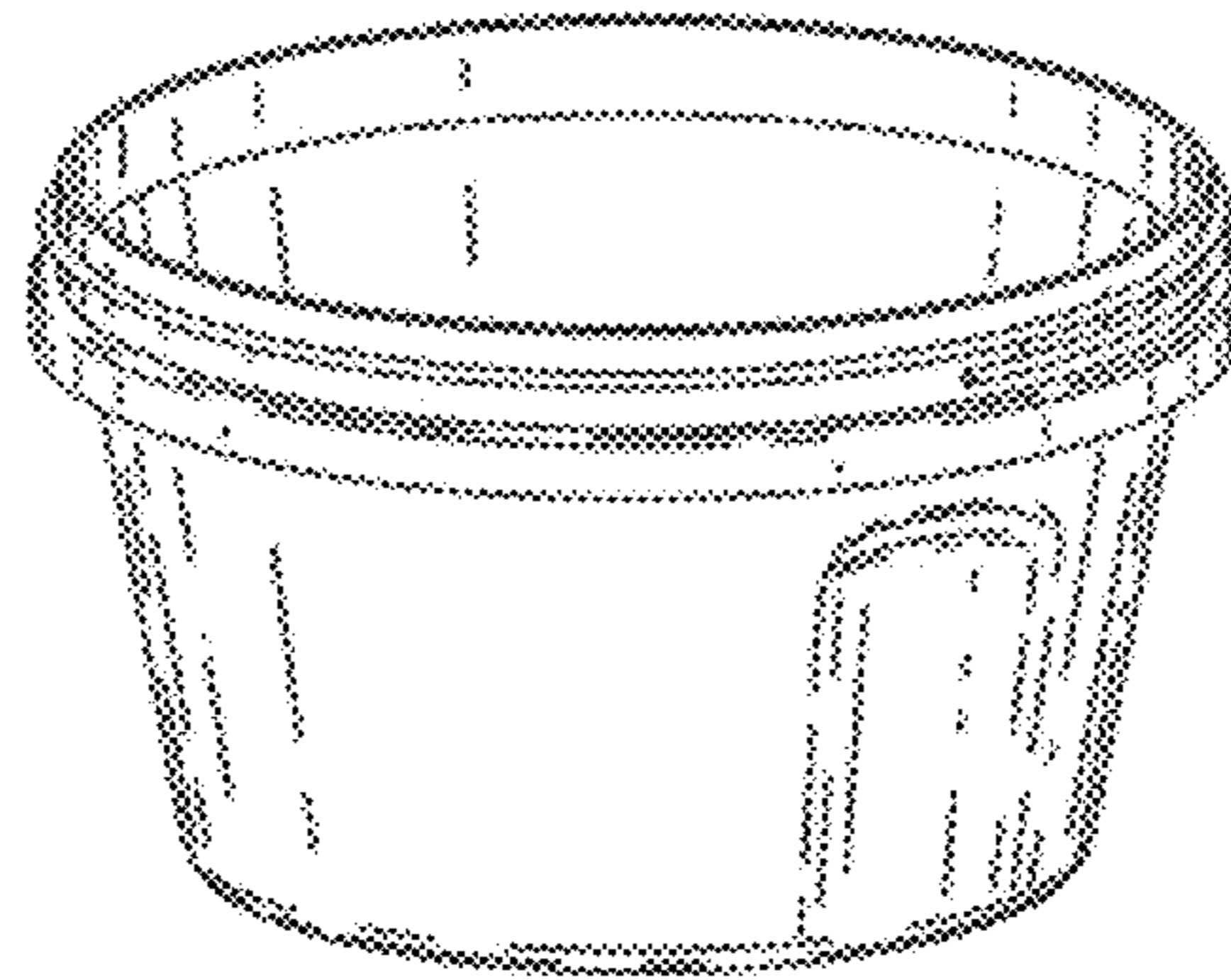

Fig. 2

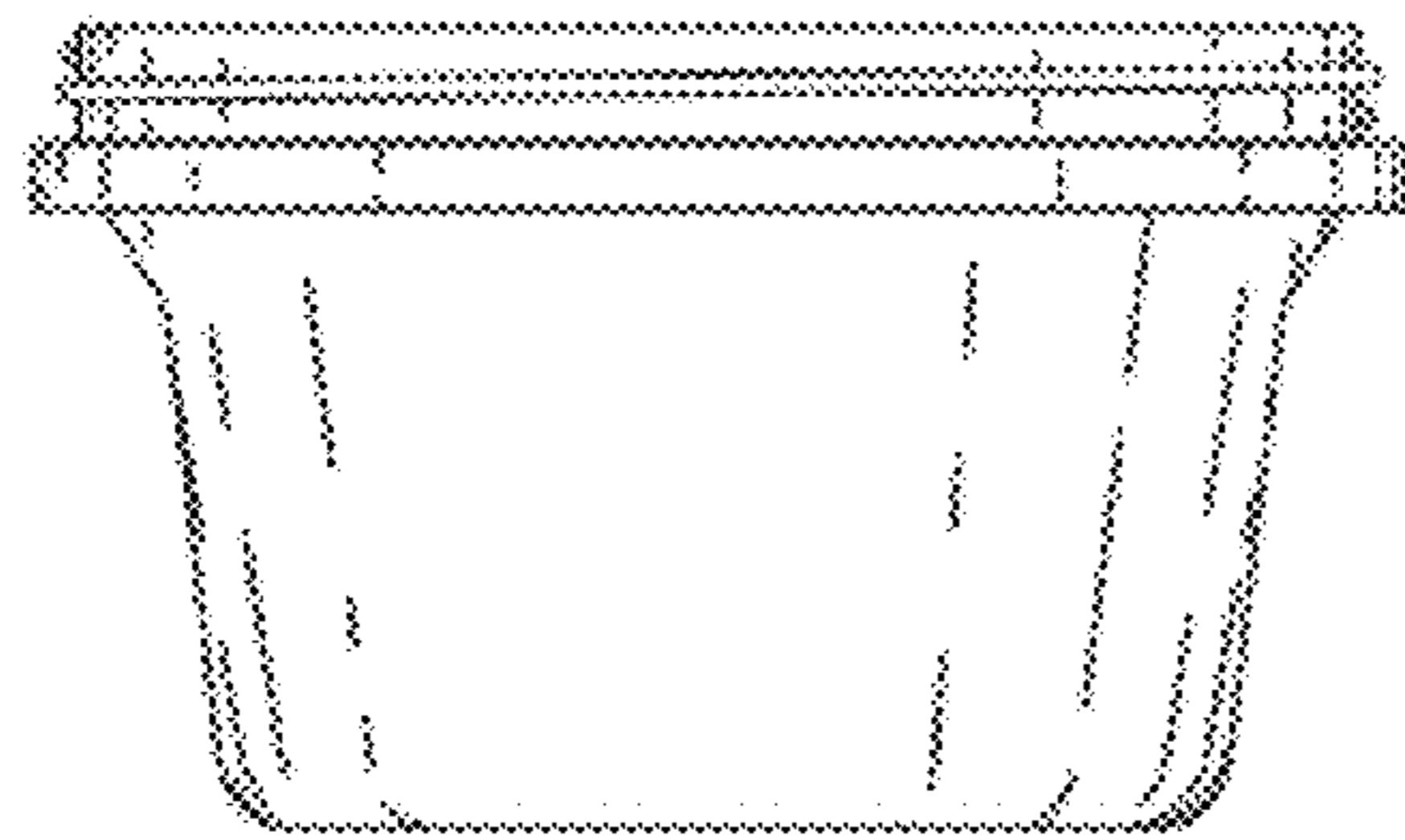

Fig. 3

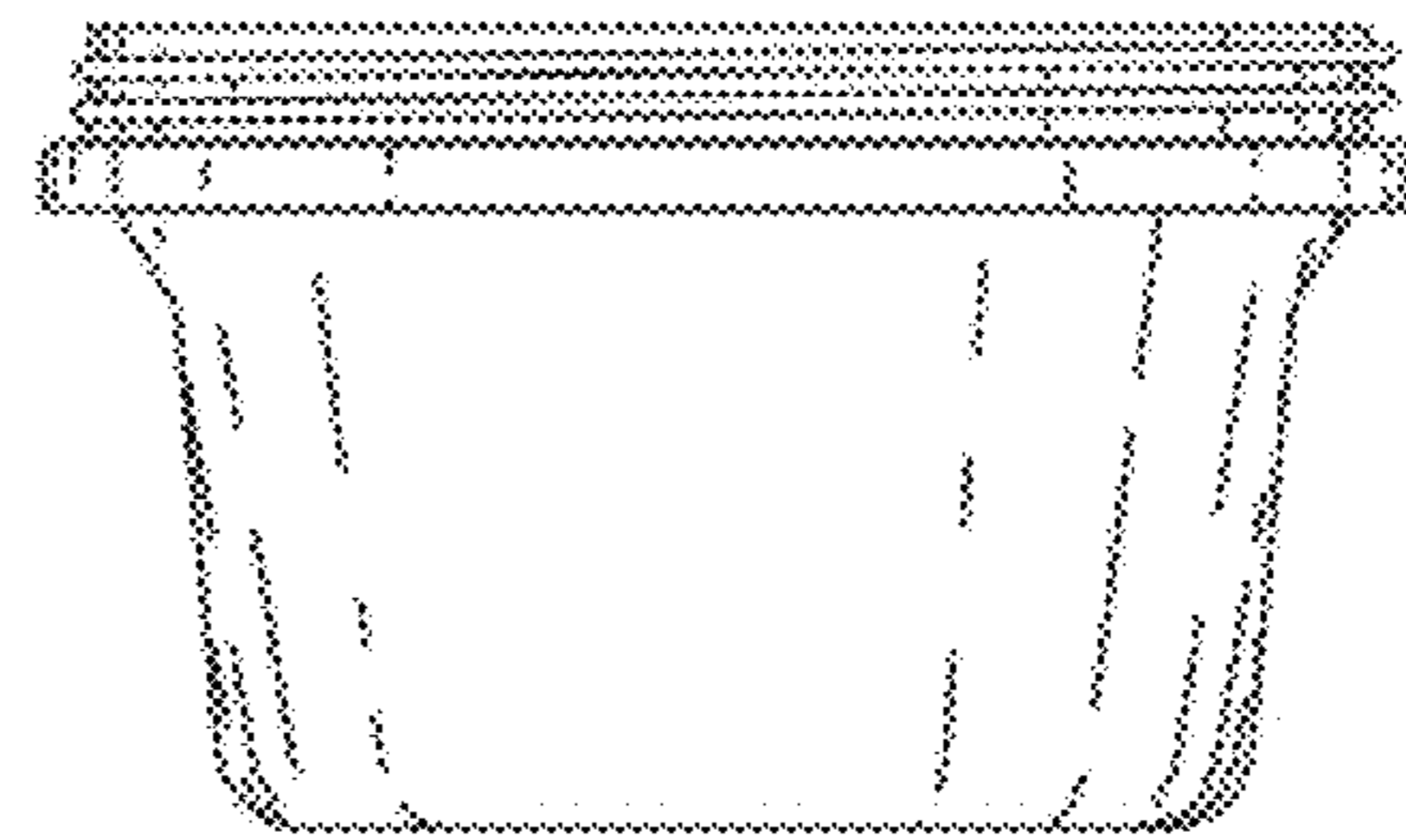

Fig. 4

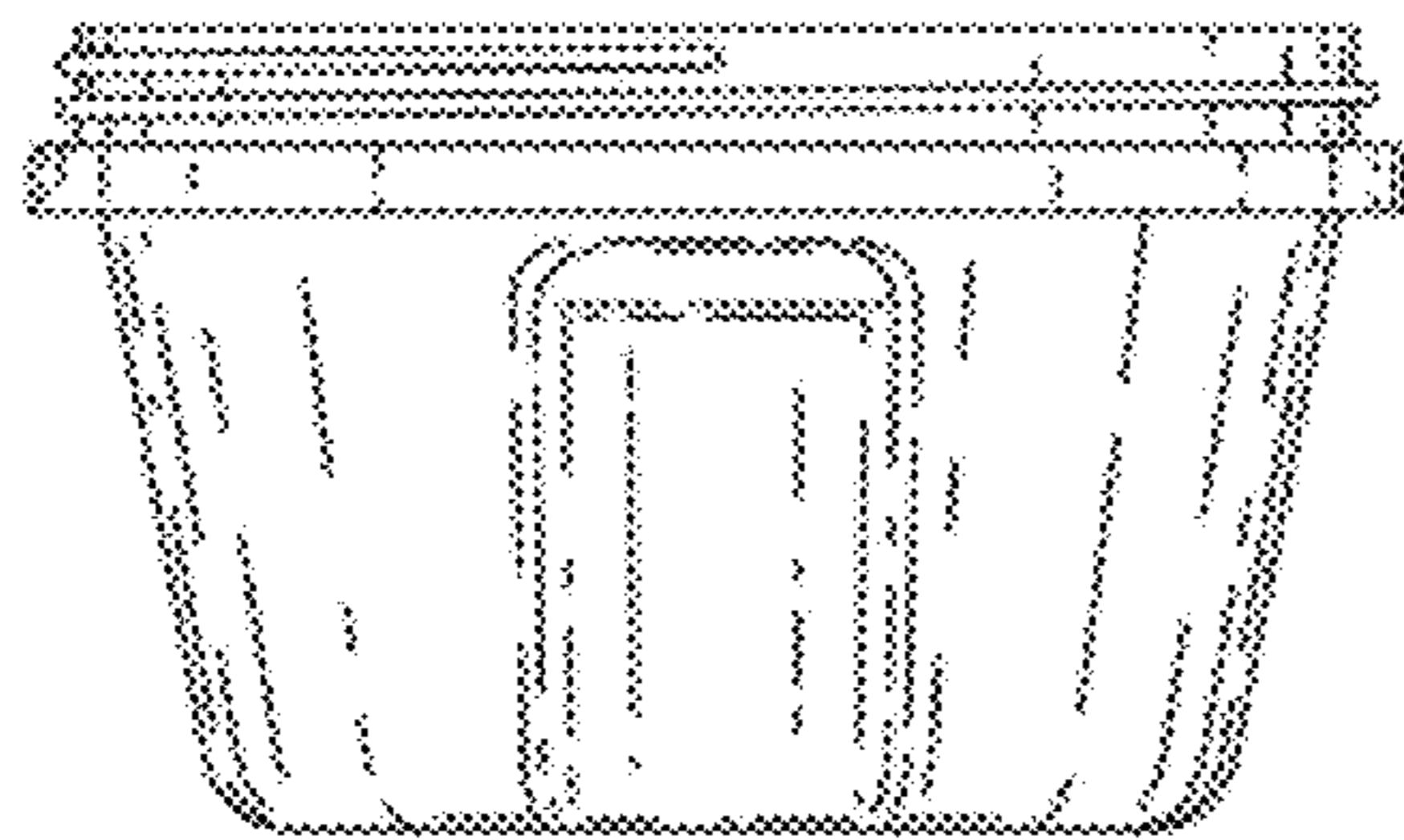

Fig. 5

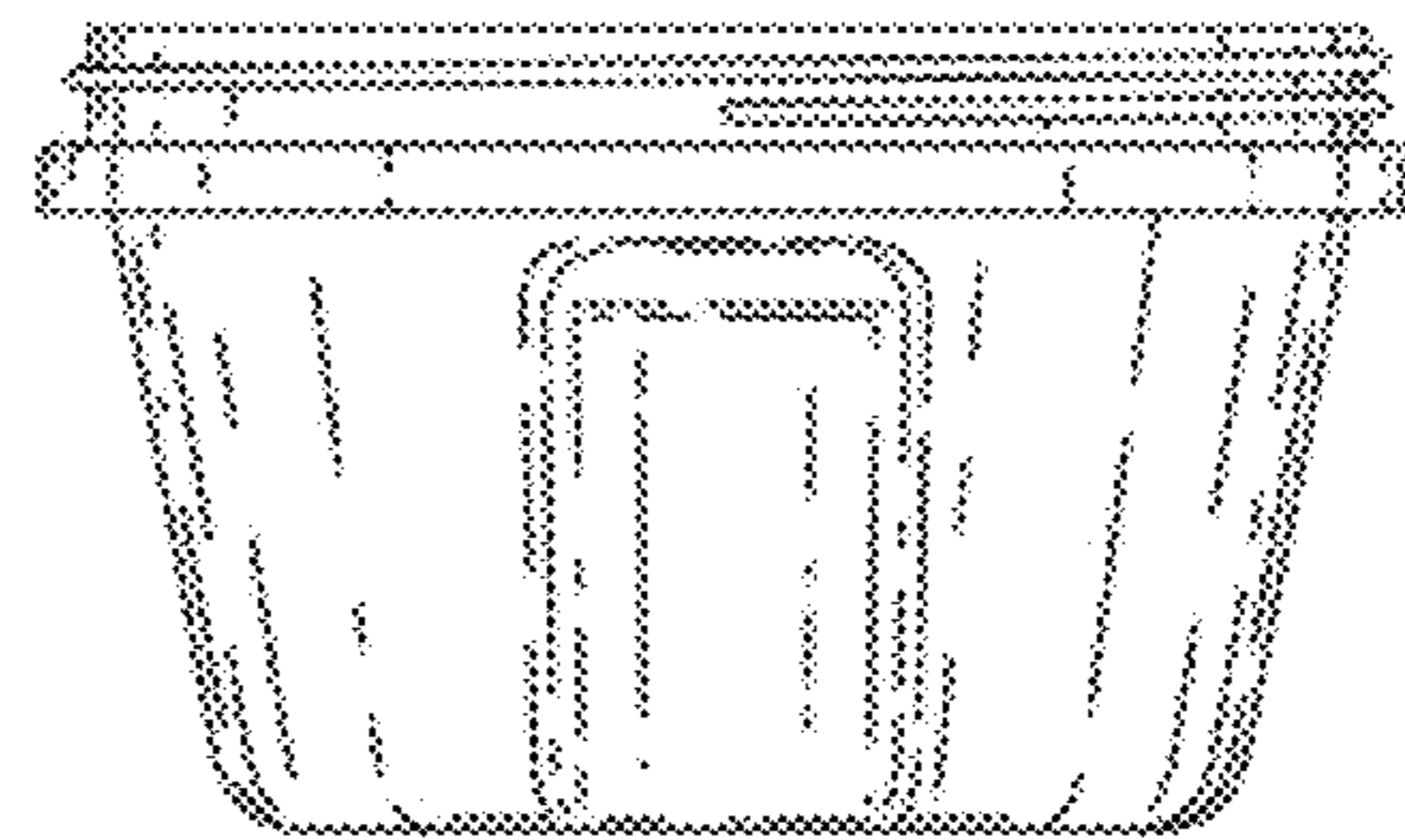

Fig. 6

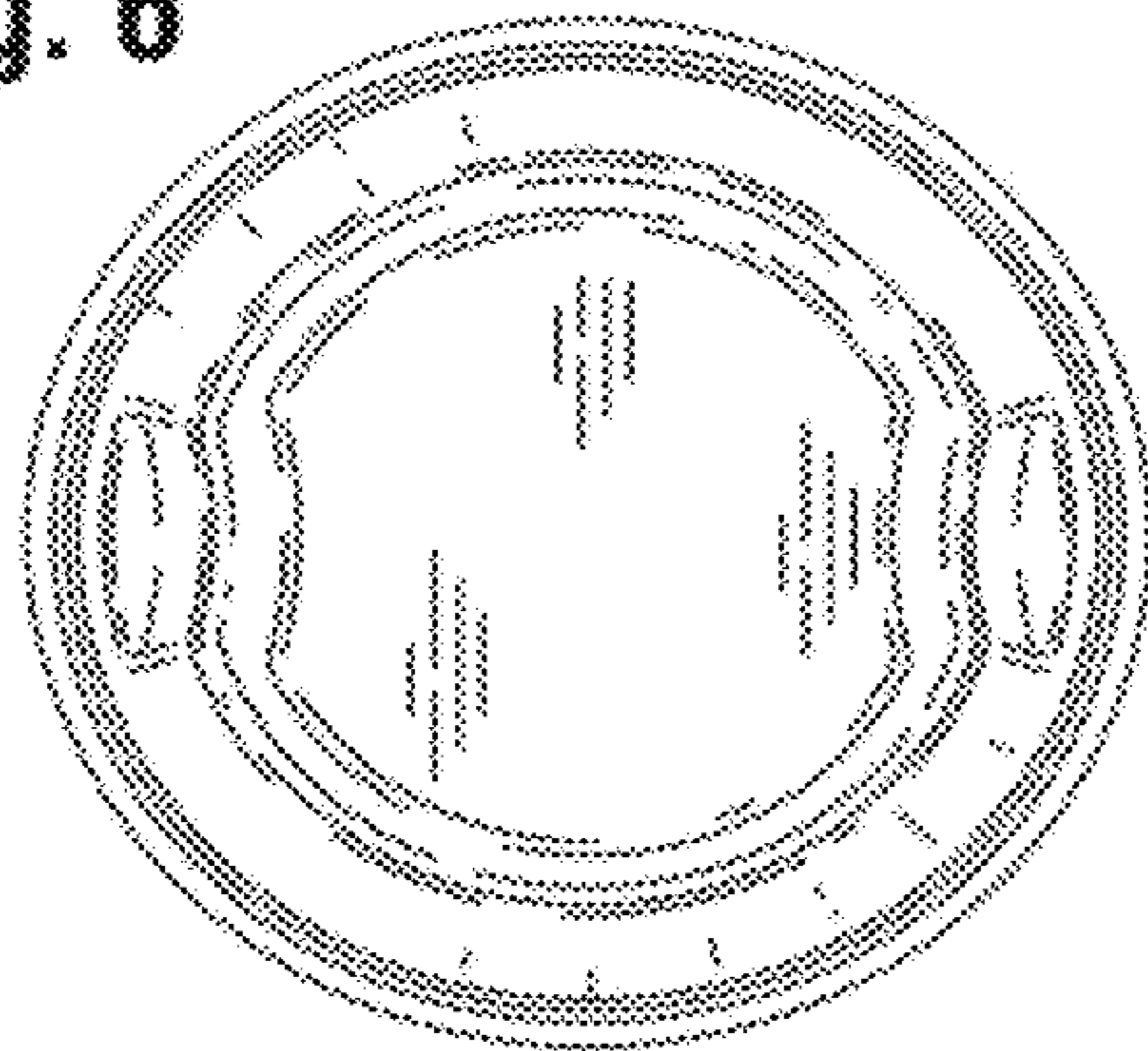

Fig. 7

