



US00D672574S

(12) **United States Design Patent**  
**Wilson, Jr.**

(10) **Patent No.:** **US D672,574 S**

(45) **Date of Patent:** **\*\* Dec. 18, 2012**

(54) **TOWEL CABINET**

(76) Inventor: **Sidney Wilson, Jr.**, Jackson, TN (US)

(\*\*) Term: **14 Years**

(21) Appl. No.: **29/408,997**

(22) Filed: **Dec. 19, 2011**

(51) **LOC (9) Cl.** ..... **06-04**

(52) **U.S. Cl.** ..... **D6/432**

(58) **Field of Classification Search** ..... D6/300,  
D6/309, 396, 420, 425, 432-448, 460-468,  
D6/474-479, 491-495, 509, 559, 561; D12/319;  
D13/184; 248/188, 188.1, 188.8; 312/107-109,  
312/138.1, 194, 198, 204-217, 224-237,  
312/257.1, 278-279

See application file for complete search history.

(56) **References Cited**

**U.S. PATENT DOCUMENTS**

D327,793 S *	7/1992	McGrory	.....	D6/448
D423,814 S *	5/2000	Belka et al.	.....	D6/432
D492,508 S *	7/2004	Anderson et al.	.....	D6/448
D492,509 S *	7/2004	Anderson et al.	.....	D6/448
D495,162 S *	8/2004	Anderson et al.	.....	D6/432
D505,568 S *	5/2005	Moon et al.	.....	D6/432
D505,806 S *	6/2005	Moon et al.	.....	D6/448
D509,081 S *	9/2005	Anderson et al.	.....	D6/432

D516,834 S *	3/2006	Masseth, Jr.	.....	D6/432
7,524,002 B2 *	4/2009	Punzel et al.	.....	312/217
D611,398 S *	3/2010	Tsuboi	.....	D12/319
D623,433 S *	9/2010	Richardson et al.	.....	D6/432
D663,134 S *	7/2012	Wu	.....	D6/432

\* cited by examiner

*Primary Examiner* — Ricky Pham

(74) *Attorney, Agent, or Firm* — QuickPatents, Inc.; Kevin Prince

(57) **CLAIM**

I claim the ornamental design for a towel cabinet, as shown and described.

**DESCRIPTION**

FIG. 1 is a perspective view of a towel cabinet showing my new design in a partially open position; FIG. 2 is a front elevational view of FIG. 1; FIG. 3 is a rear elevational view of FIG. 1; FIG. 4 is a left-side elevational view of FIG. 1; FIG. 5 is a top plan view of FIG. 1; FIG. 6 is a bottom plan view of FIG. 1; FIG. 7 is a right-side elevational view of FIG. 1; and, FIG. 8 is a perspective view thereof, illustrated in a closed position.

**1 Claim, 3 Drawing Sheets**

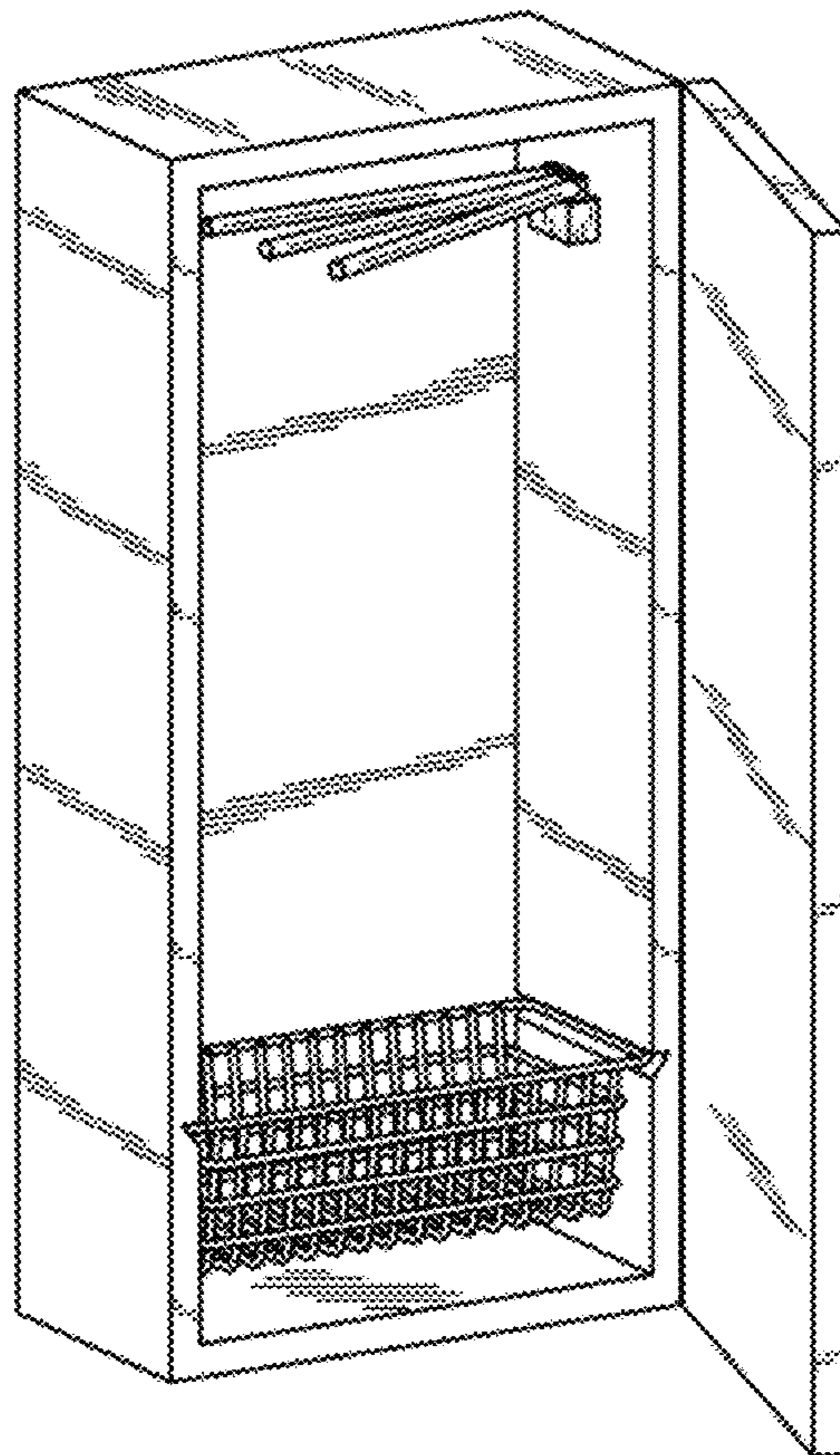

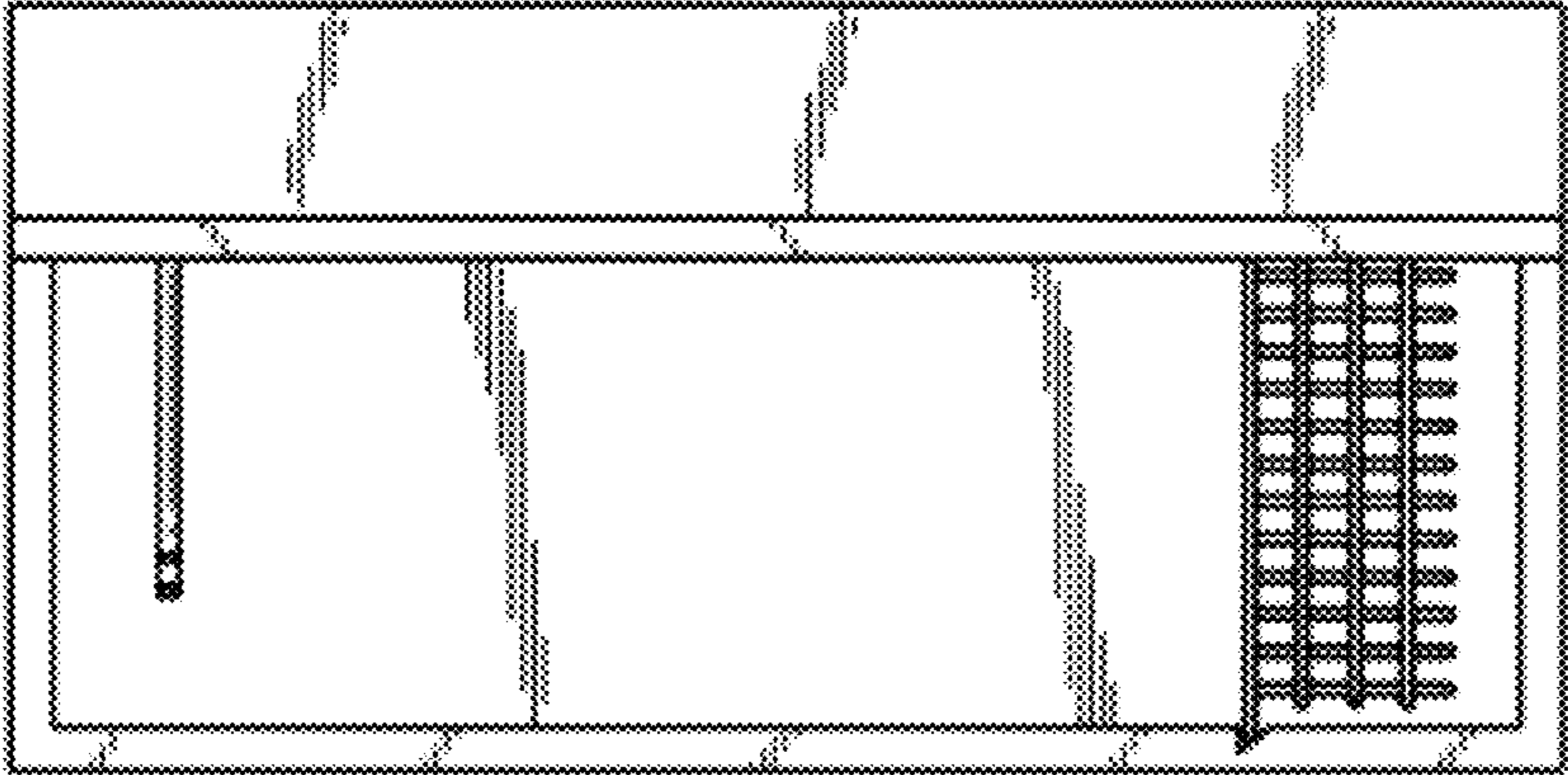

FIG. 2

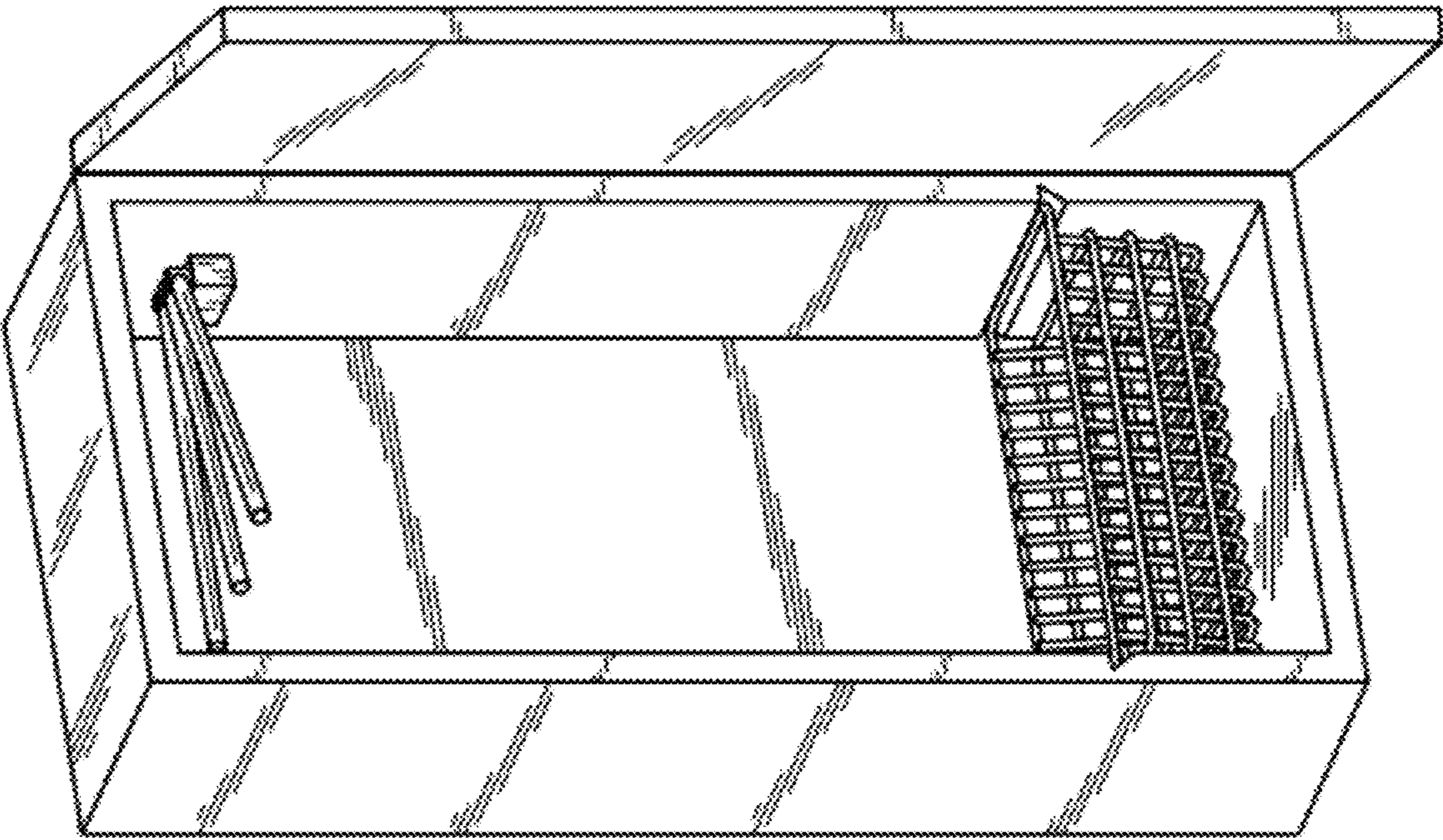

FIG. 1



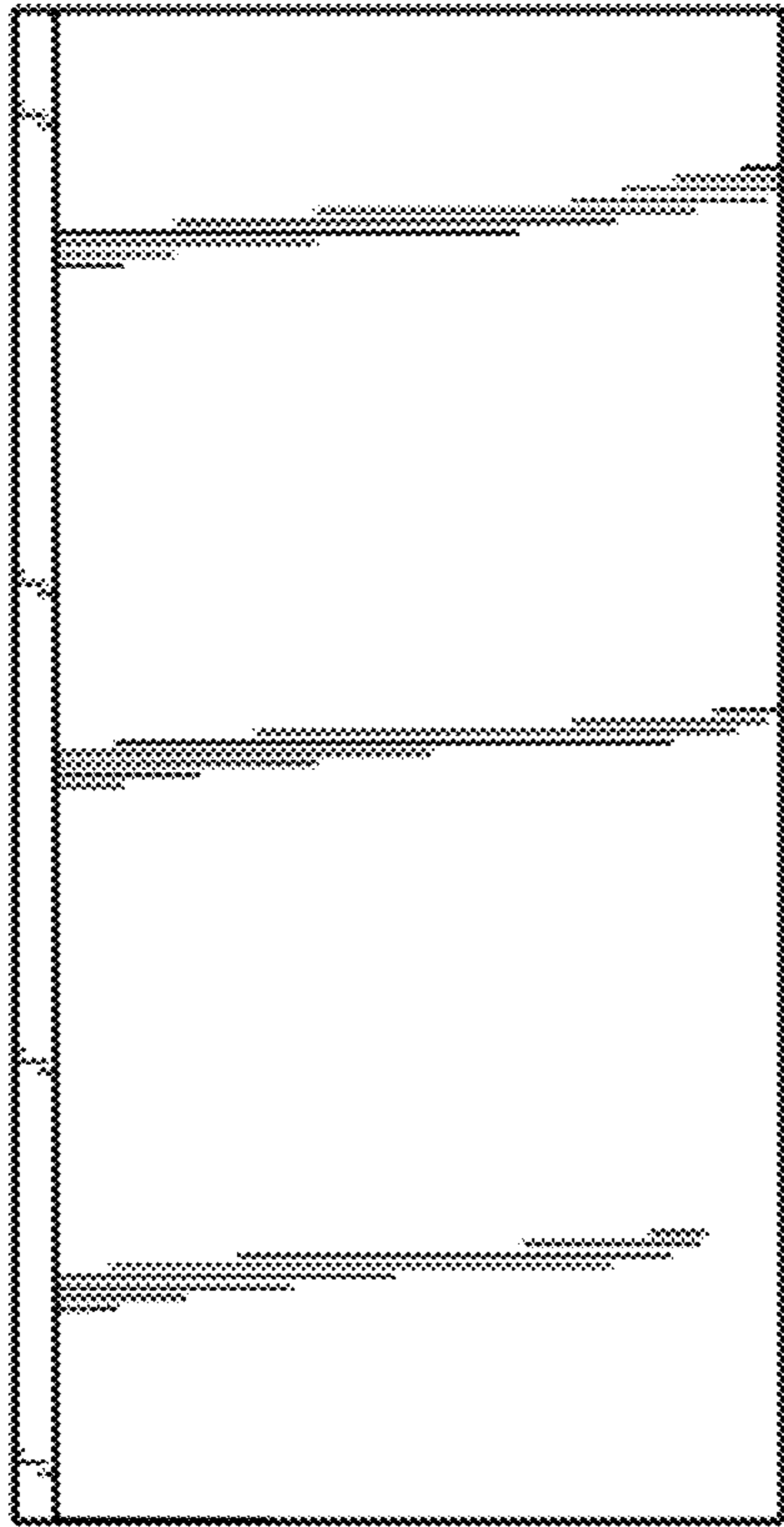

FIG. 3

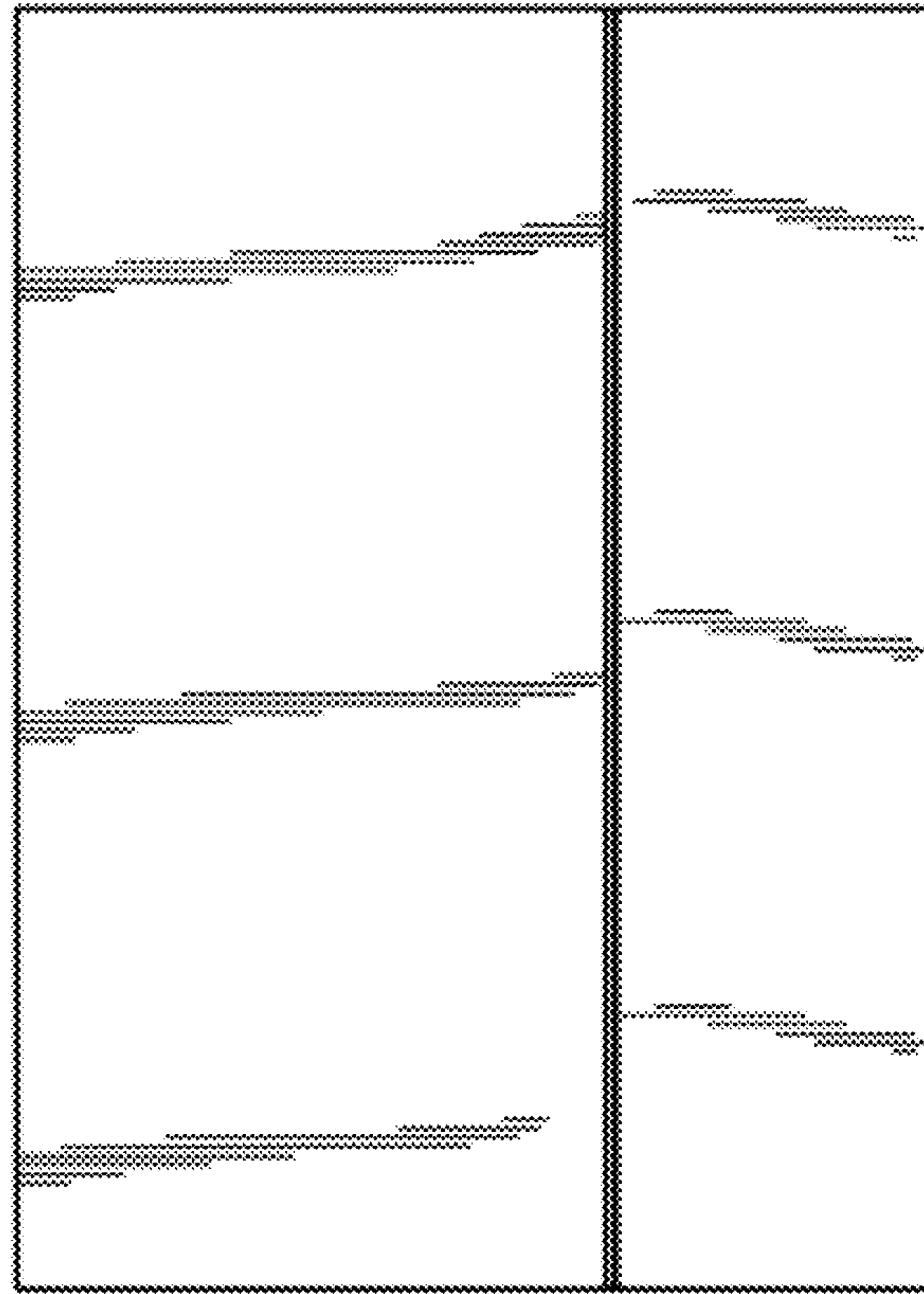

FIG. 4

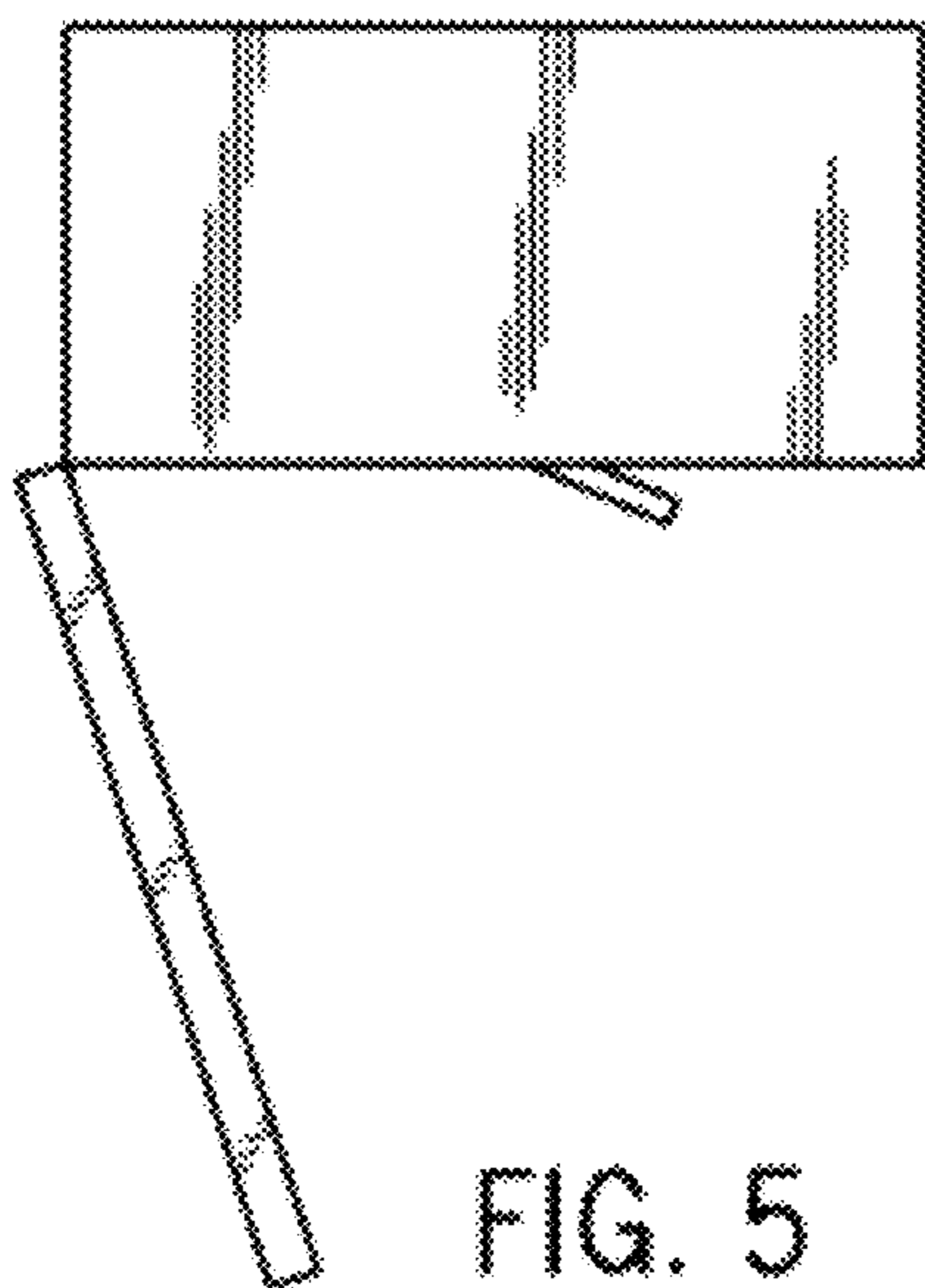

FIG. 5

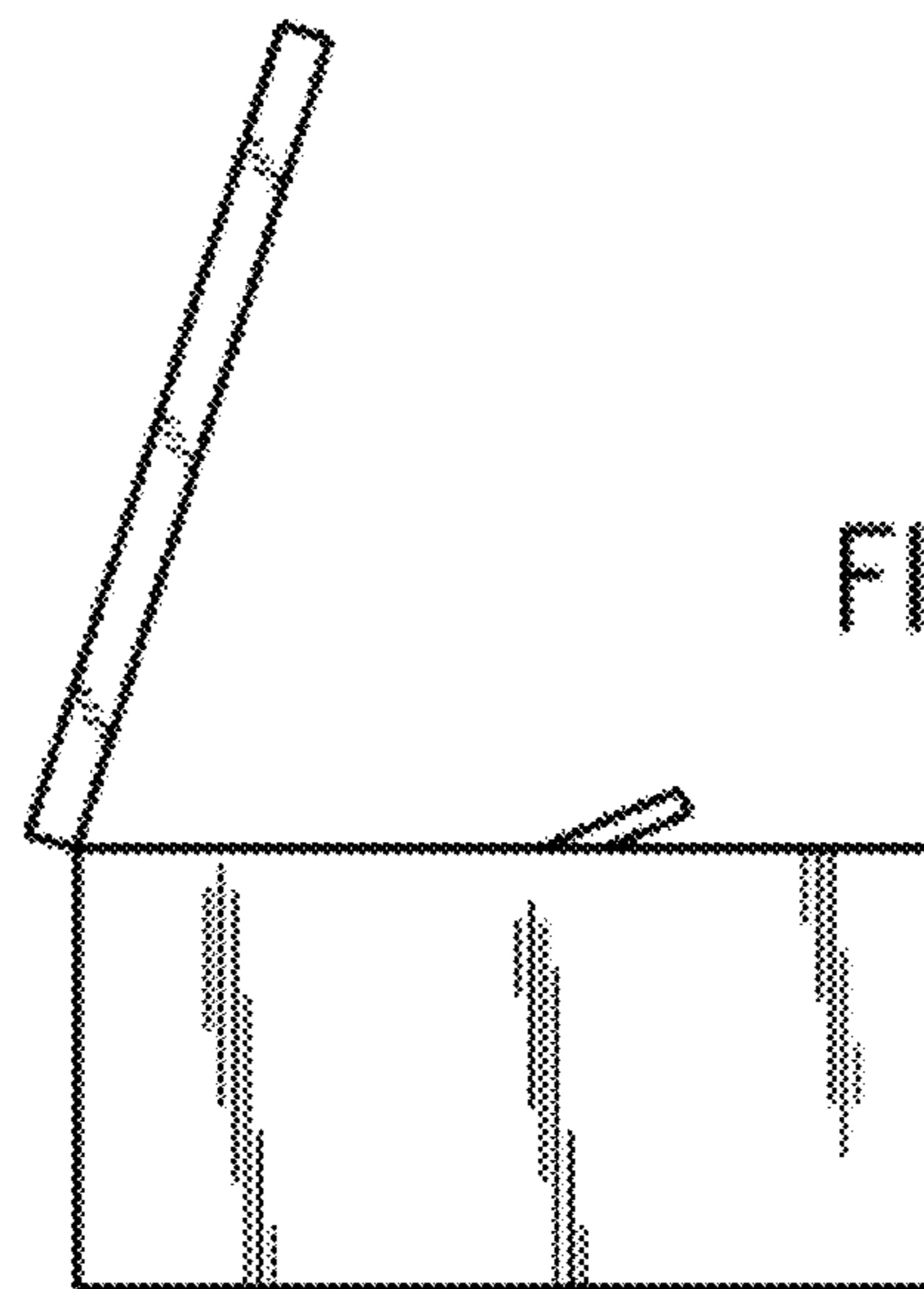

FIG. 6

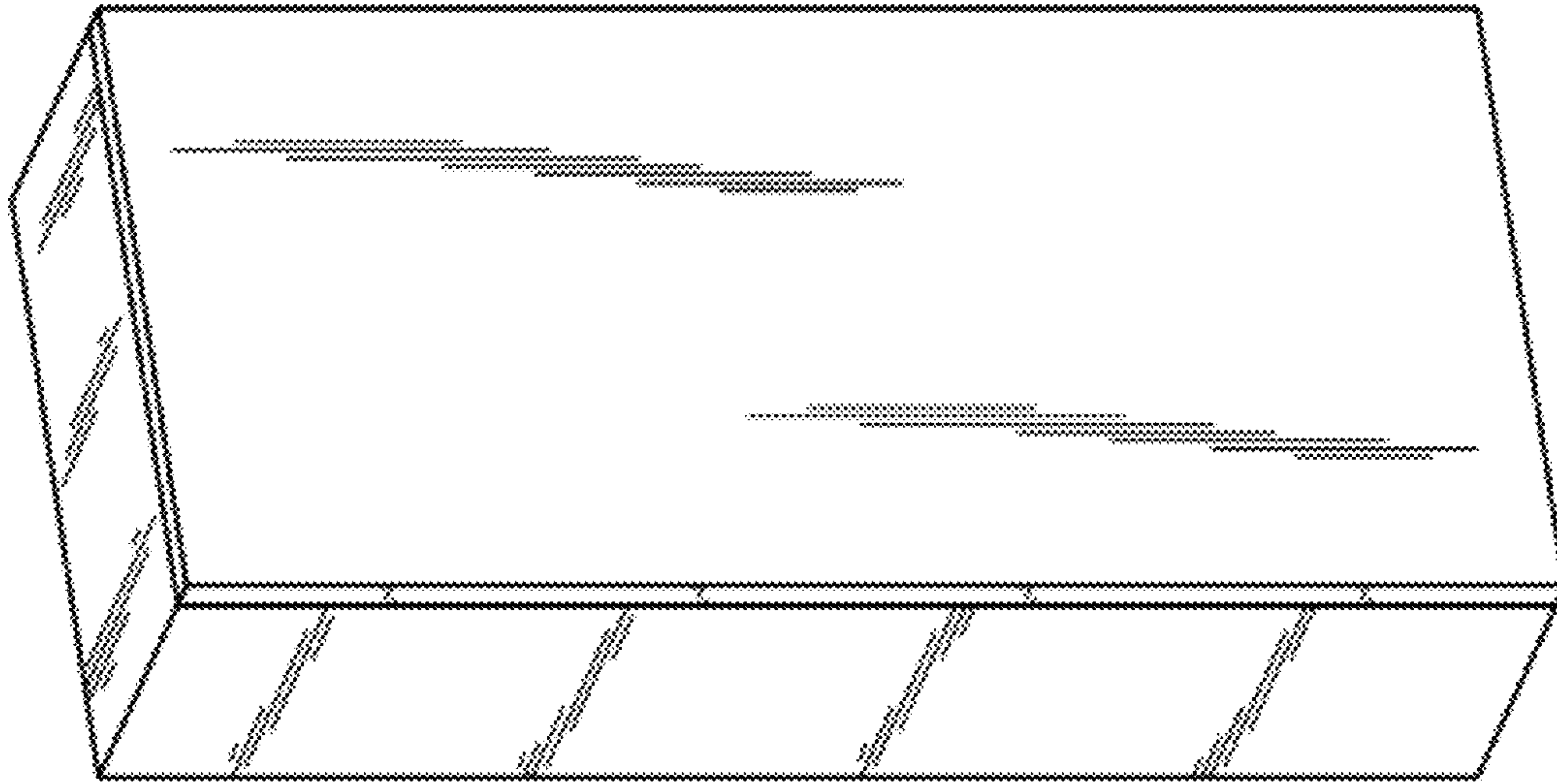

FIG. 8

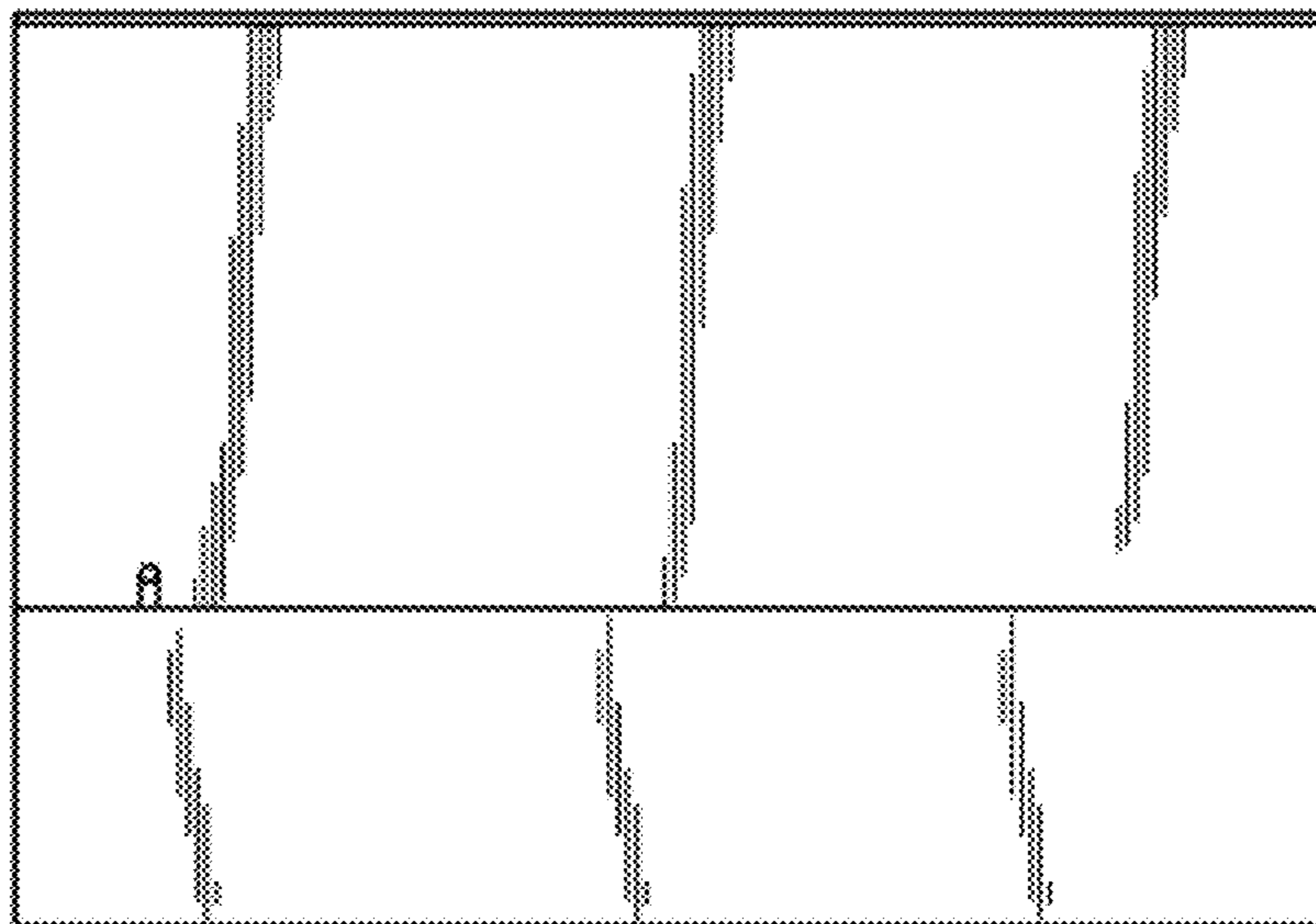

FIG. 7