



US00D672553S

(12) **United States Design Patent**
Devillier

(10) **Patent No.:** **US D672,553 S**

(45) **Date of Patent:** **** Dec. 18, 2012**

(54) **SATELLITE ENCLOSURE**

(76) Inventor: **Matt Devillier**, Breaux Bridge, LA (US)

(**) Term: **14 Years**

(21) Appl. No.: **29/388,171**

(22) Filed: **Mar. 24, 2011**

(51) **LOC (9) Cl.** **03-01**

(52) **U.S. Cl.** **D3/272; D3/274**

(58) **Field of Classification Search** D3/272,
D3/273, 274; D34/28, 38, 39; 206/386,
206/595, 596, 597, 598, 599, 600; 220/1.5
See application file for complete search history.

D580,170 S 11/2008 Klotzman et al.
D580,653 S * 11/2008 Robaina D3/272
D611,252 S 3/2010 Fiscus
D647,700 S * 11/2011 Sayag D3/272
2012/0103848 A1 * 5/2012 Allegretti et al. 206/386

* cited by examiner

Primary Examiner — Jennifer Rivard

(74) *Attorney, Agent, or Firm* — QuikPatents, Inc.; Kevin Prince

(57) **CLAIM**

I claim the ornamental design for a satellite enclosure, as shown and described.

(56) **References Cited**

U.S. PATENT DOCUMENTS

3,828,964	A *	8/1974	Bonnot	220/1.5
D245,319	S	8/1977	Wodell		
4,213,532	A *	7/1980	Eggert et al.	206/504
D277,042	S	1/1985	Carter et al.		
D289,108	S	4/1987	Guibault		
D414,333	S *	9/1999	Barber et al.	D3/272
D422,770	S *	4/2000	Schmitt	D34/38
D431,358	S	10/2000	Willemsen		
D453,603	S	2/2002	Bray et al.		
D466,300	S	12/2002	Walsh		
D466,690	S	12/2002	Walsh		
D467,730	S	12/2002	Ekerot et al.		
D473,052	S	4/2003	Dehenau		
D492,835	S	7/2004	Michaels et al.		
D522,769	S	6/2006	Davis		
D580,169	S *	11/2008	Gibson	D3/272

DESCRIPTION

FIG. 1 is a perspective view of a satellite enclosure, showing my new design;
FIG. 2 is a front elevational view thereof;
FIG. 3 is a rear elevational view thereof;
FIG. 4 is a right-side elevational view thereof;
FIG. 5 is a left-side elevational view thereof;
FIG. 6 is a top plan view thereof; and,
FIG. 7 is a bottom plan view thereof.
The broken lines showing a crane hook and cables in FIG. 1 and interior features in FIG. 7 depict environmental matter while the invention is in use, and form no part of the claimed design.

1 Claim, 3 Drawing Sheets

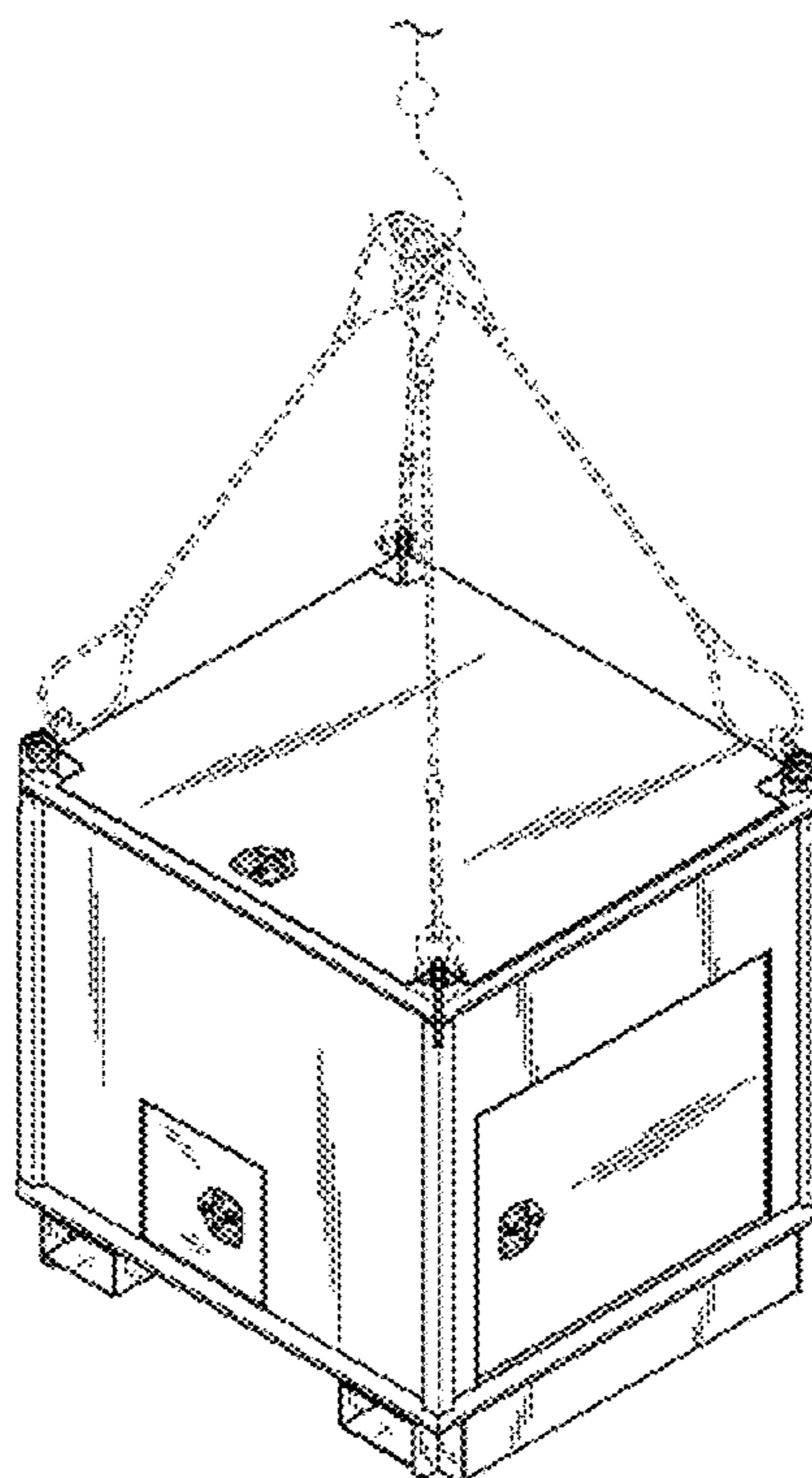

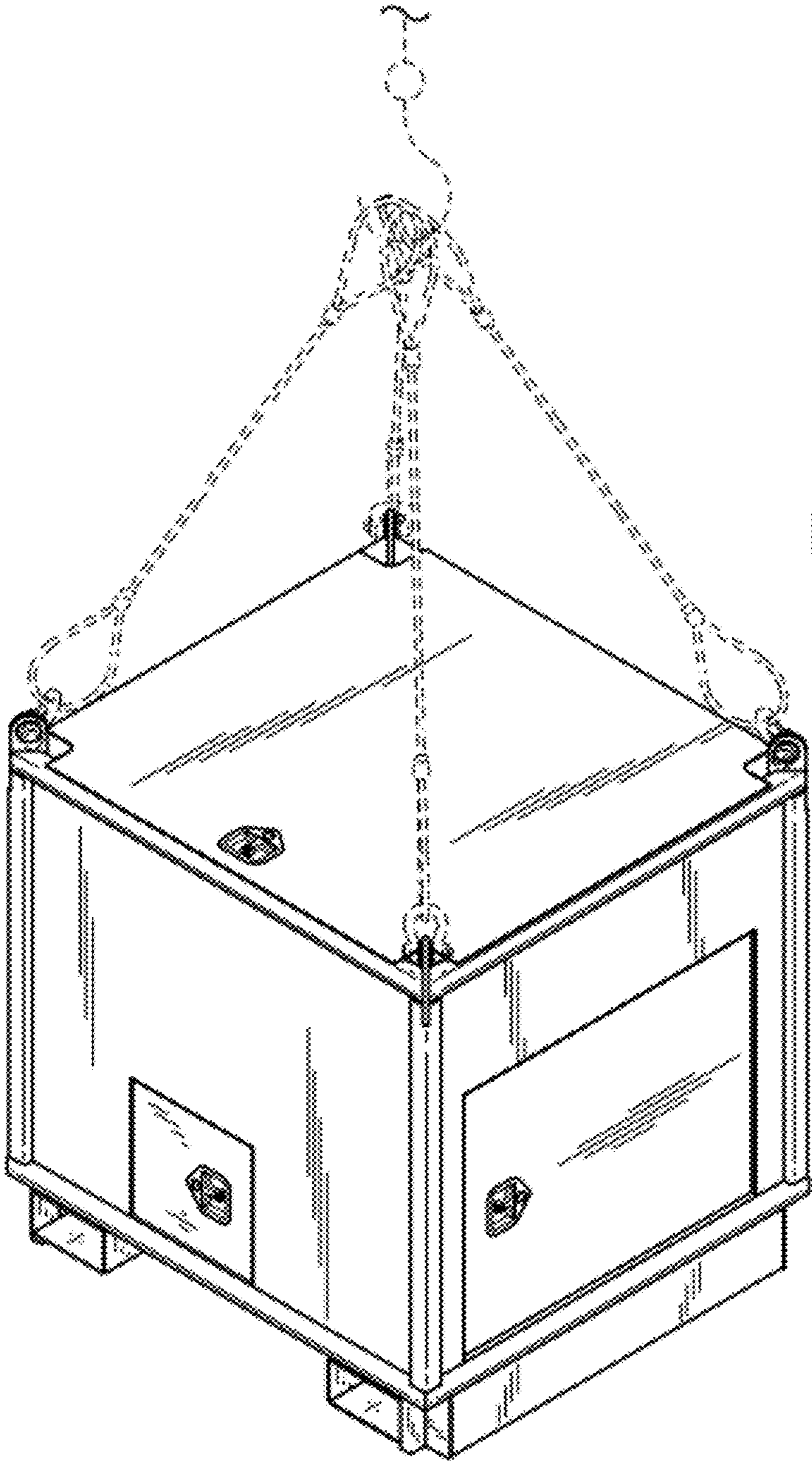

FIG. 1

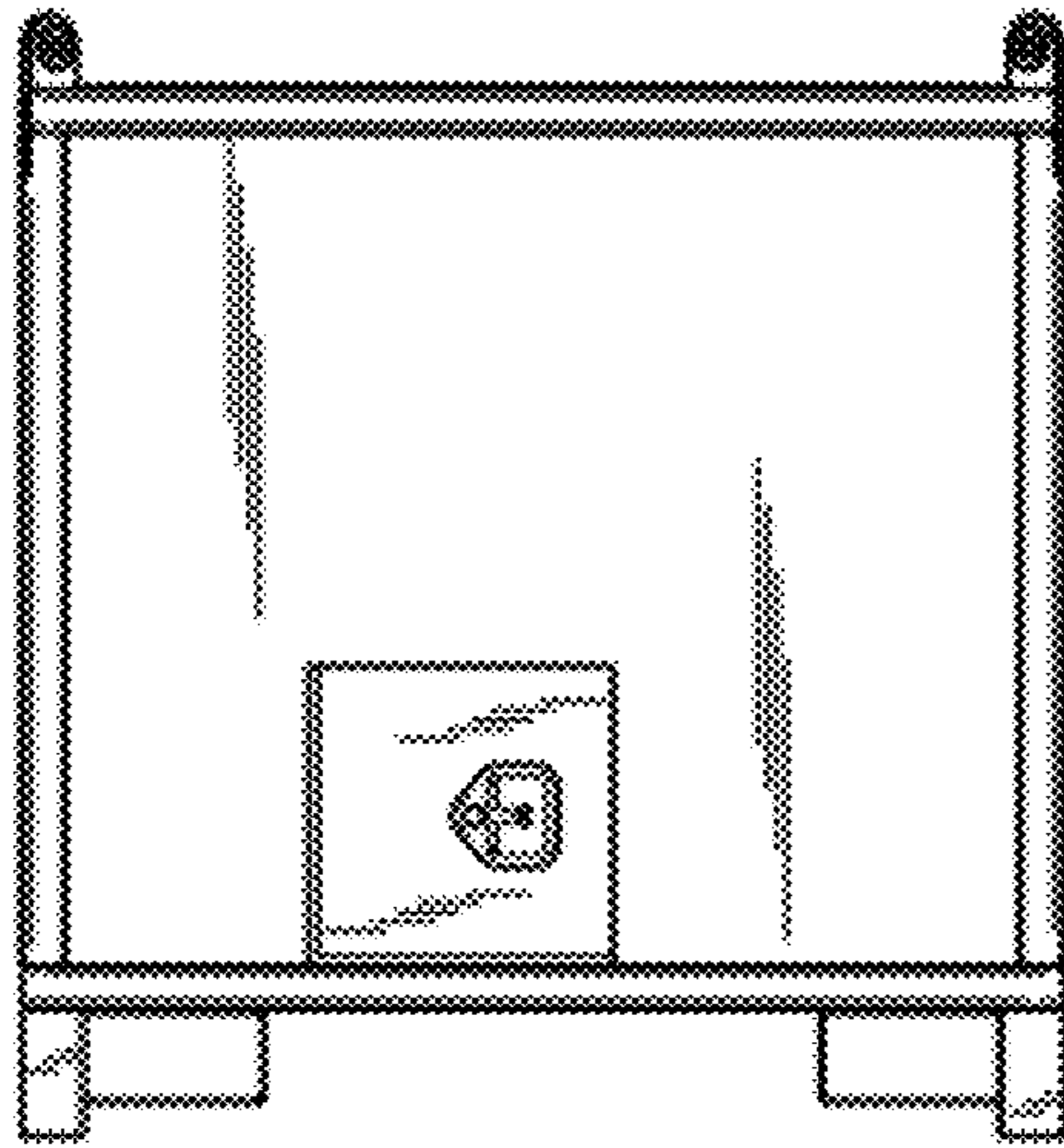

FIG. 2

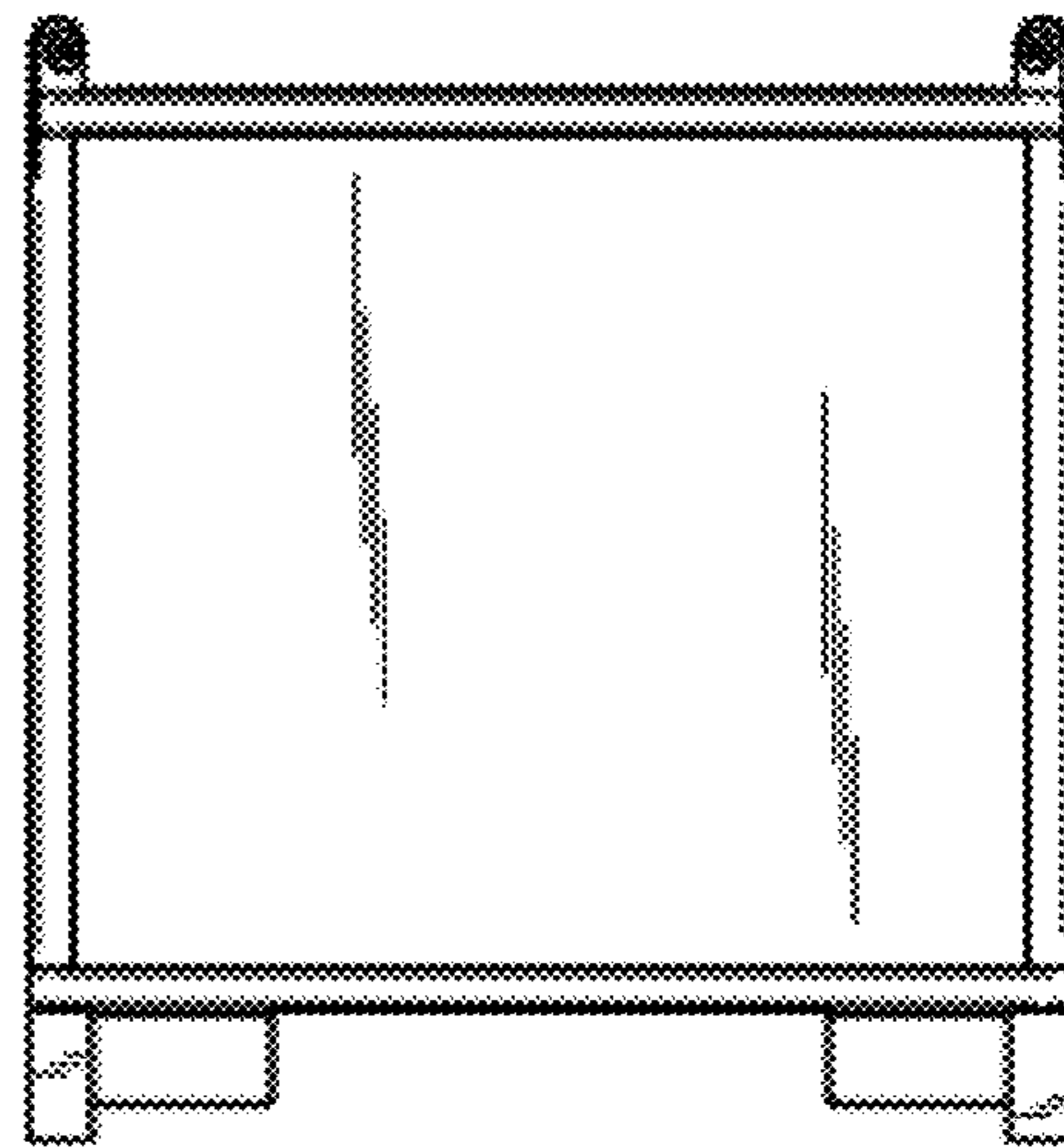

FIG. 3

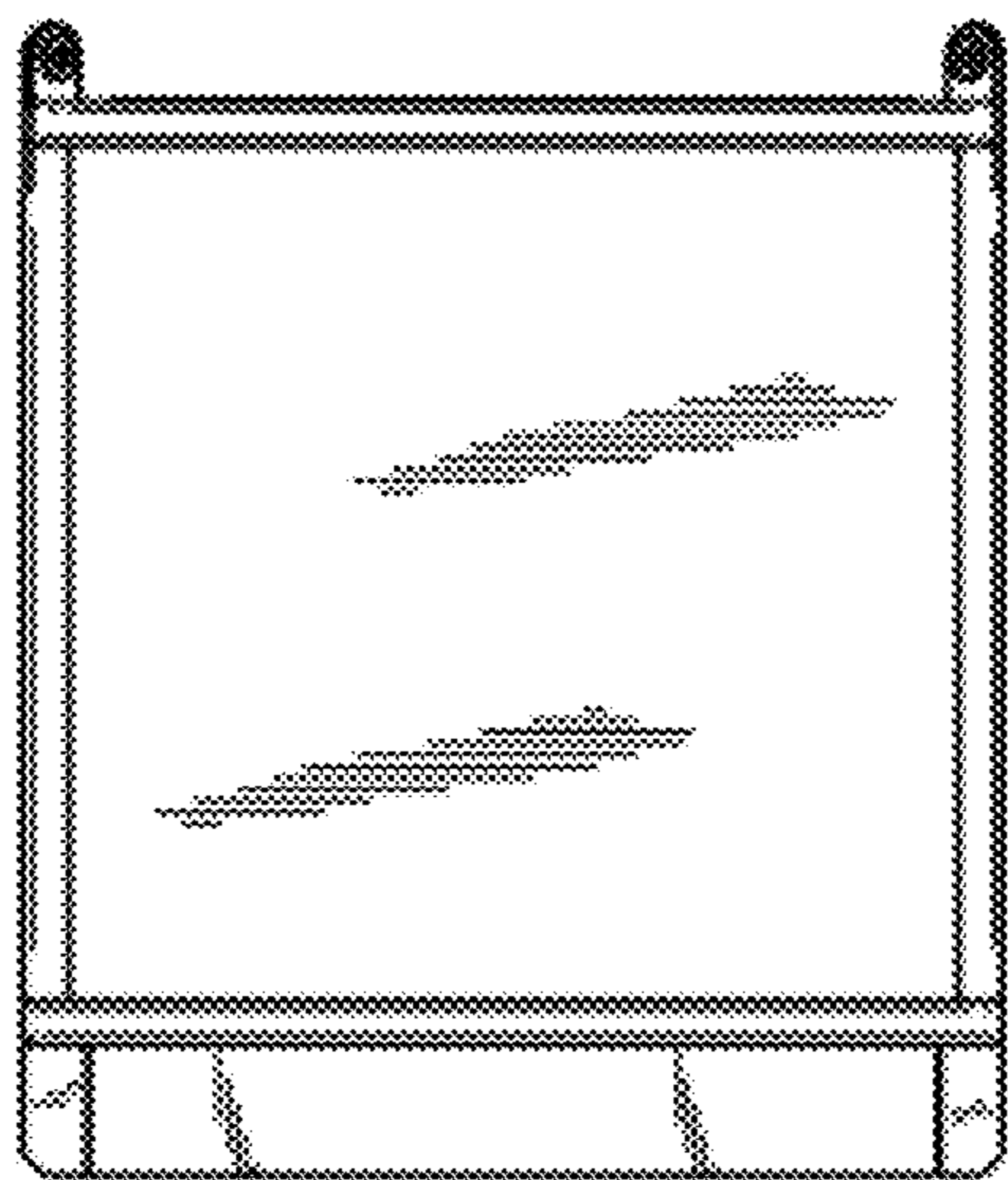

FIG. 4

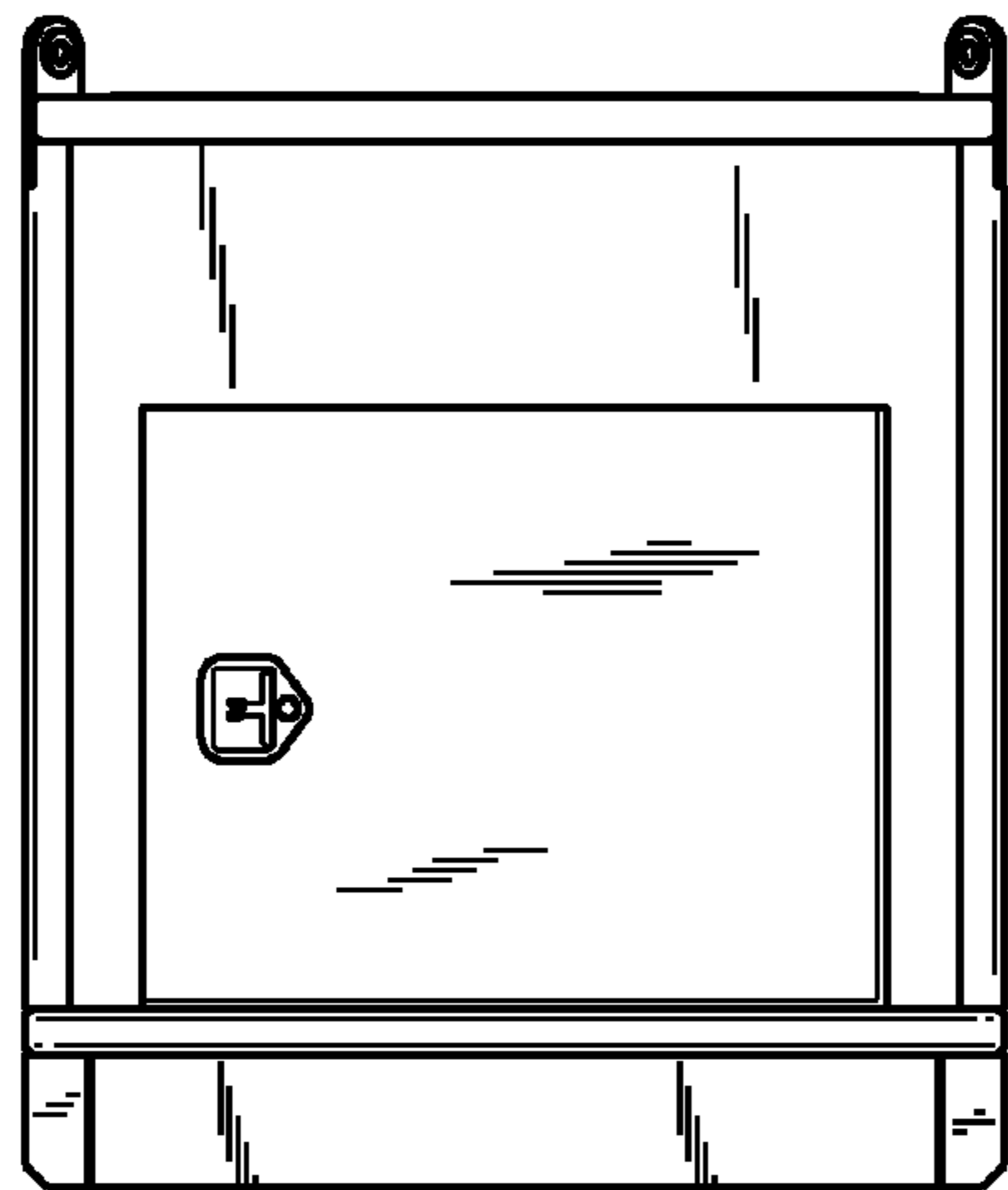

FIG. 5

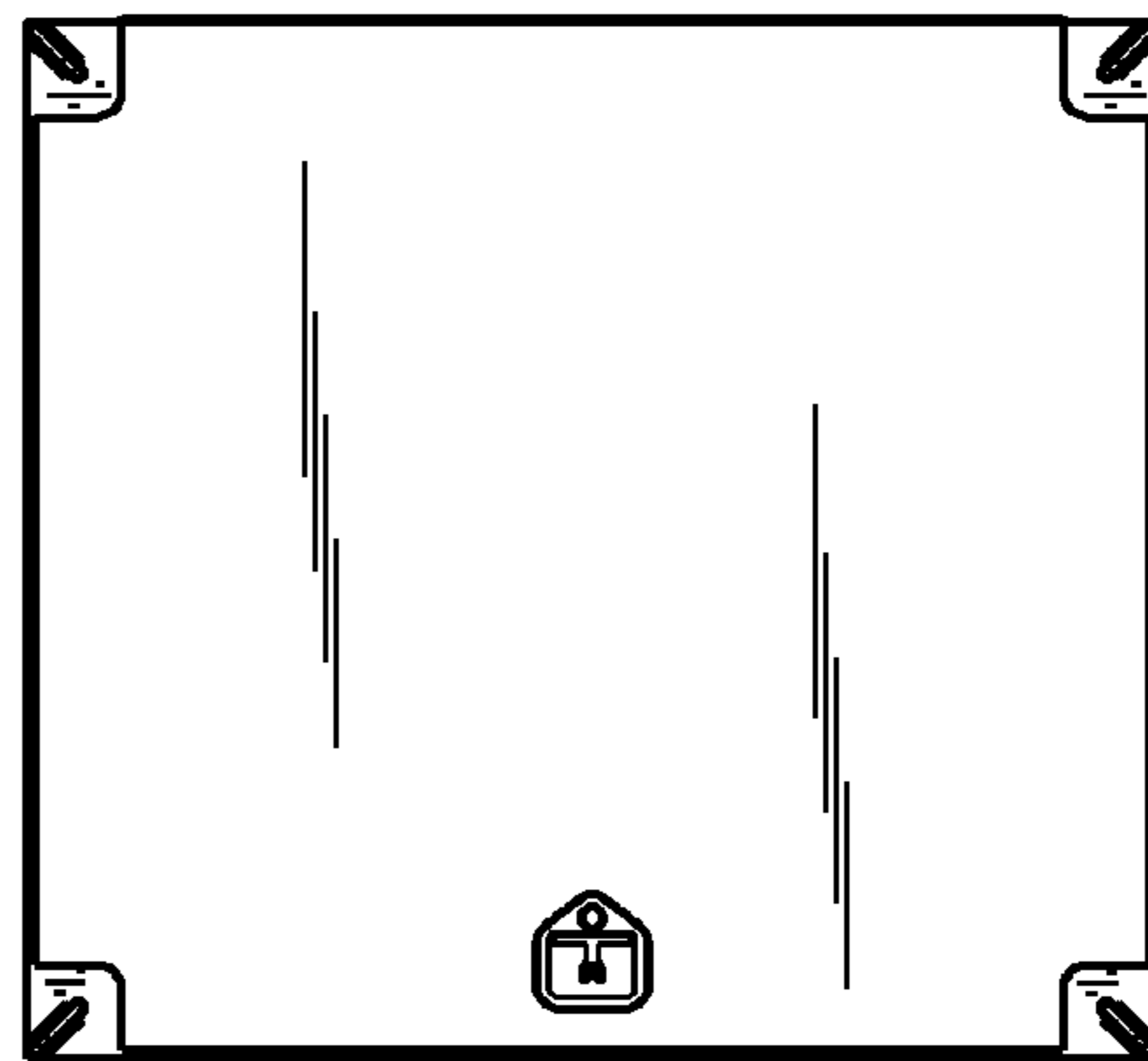

FIG. 6

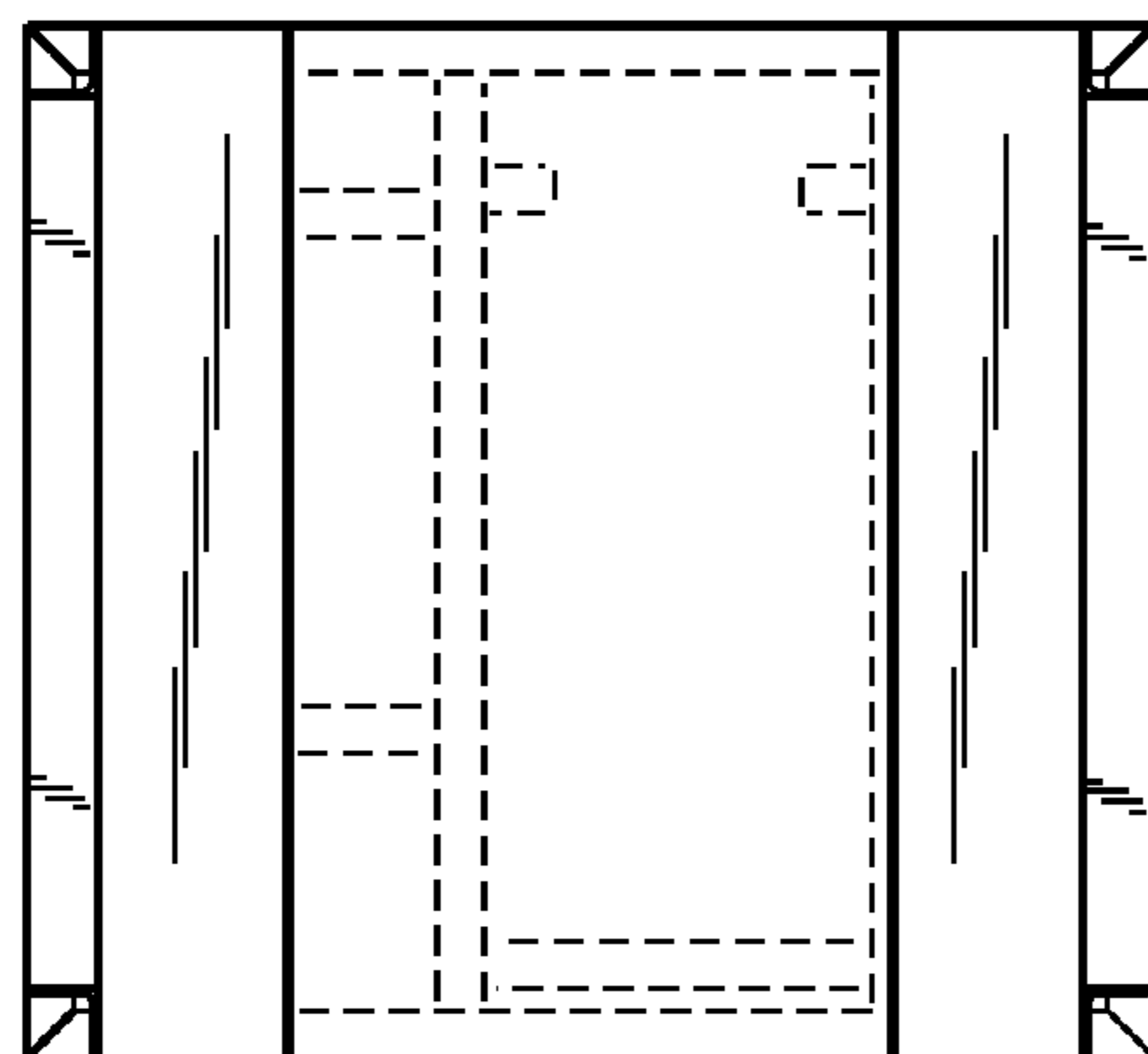

FIG. 7