



US00D672498S

(12) **United States Design Patent**
Kim

(10) **Patent No.:** **US D672,498 S**

(45) **Date of Patent:** **** Dec. 11, 2012**

(54) **HAIR IRON**

(75) Inventor: **Hae Jin Kim**, Seoul (KR)

(73) Assignee: **B2Y, Inc.** (KR)

(**) Term: **14 Years**

(21) Appl. No.: **29/417,191**

(22) Filed: **Mar. 30, 2012**

(30) **Foreign Application Priority Data**

Feb. 22, 2012 (KR) 30-2012-0008147

(51) **LOC (9) Cl.** **28-03**

(52) **U.S. Cl.** **D28/35**

(58) **Field of Classification Search** D28/35-38;
132/223-272; 219/222, 225-226
See application file for complete search history.

(56) **References Cited**

U.S. PATENT DOCUMENTS

4,284,091	A *	8/1981	Ehmann	132/252
D306,357	S *	2/1990	Scorgie	D28/35
D441,138	S *	4/2001	Micinilio et al.	D28/37
6,554,000	B2 *	4/2003	Lin	132/232

D537,202	S *	2/2007	Shin	D28/35
D610,306	S *	2/2010	Koenemann	D28/35
D646,023	S *	9/2011	Kim	D28/35
2005/0172980	A1 *	8/2005	Julemont	132/231
2011/0061672	A1 *	3/2011	Schmider	132/226
2011/0192417	A1 *	8/2011	Catini	132/229
2012/0111354	A1 *	5/2012	Cafaro et al.	132/211

* cited by examiner

Primary Examiner — Jennifer Rivard

(74) *Attorney, Agent, or Firm* — Brinks Hofer Gilson & Lione

(57) **CLAIM**

The ornamental design for a hair iron, as shown and described.

DESCRIPTION

FIG. 1 is a perspective view of the hair iron;
FIG. 2 is a front elevational view thereof;
FIG. 3 is a left side elevational view thereof;
FIG. 4 is a right side elevational view thereof;
FIG. 5 is a top plan view thereof;
FIG. 6 is a bottom plan view thereof; and,
FIG. 7 is a rear perspective view thereof.

1 Claim, 6 Drawing Sheets

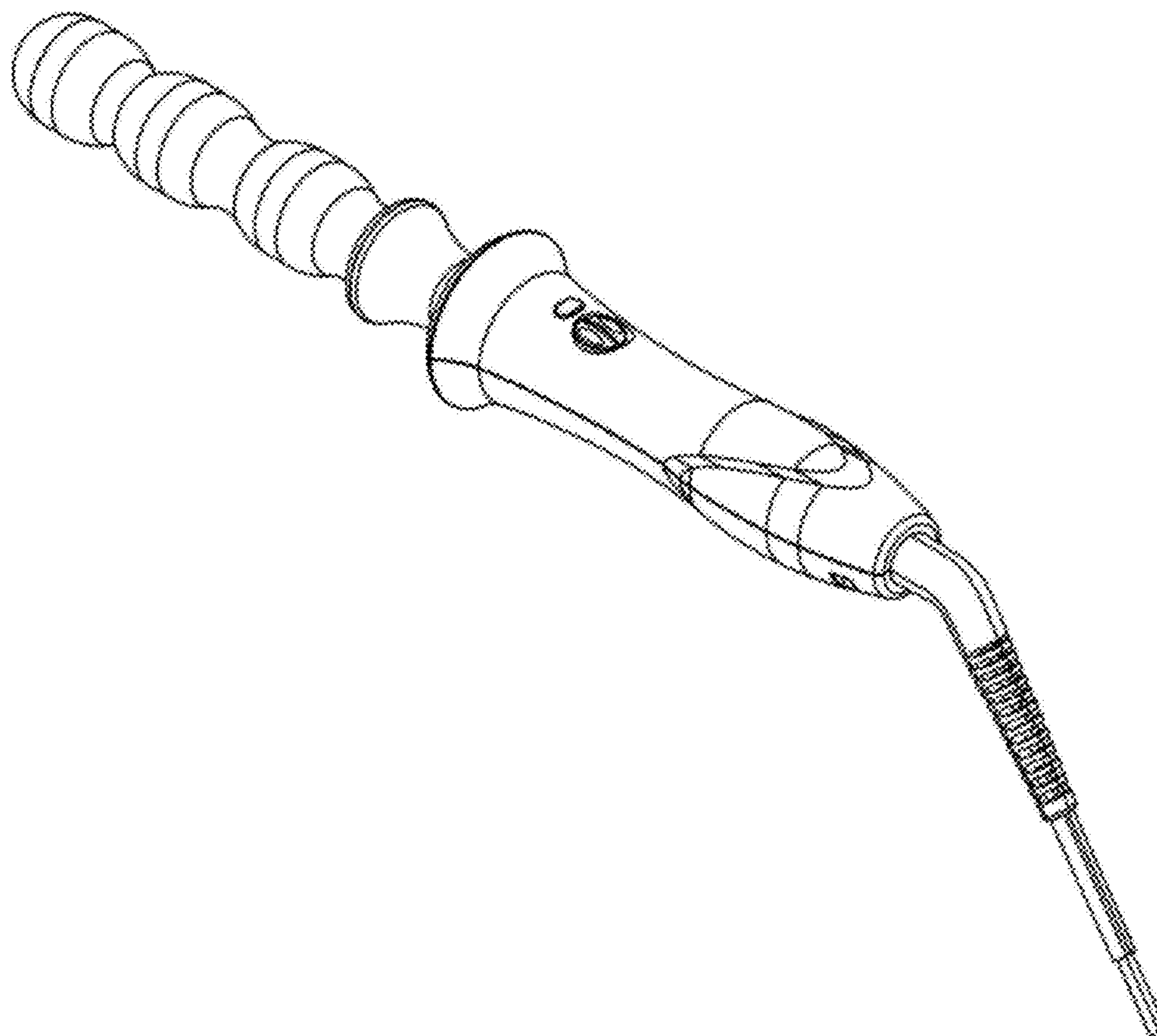

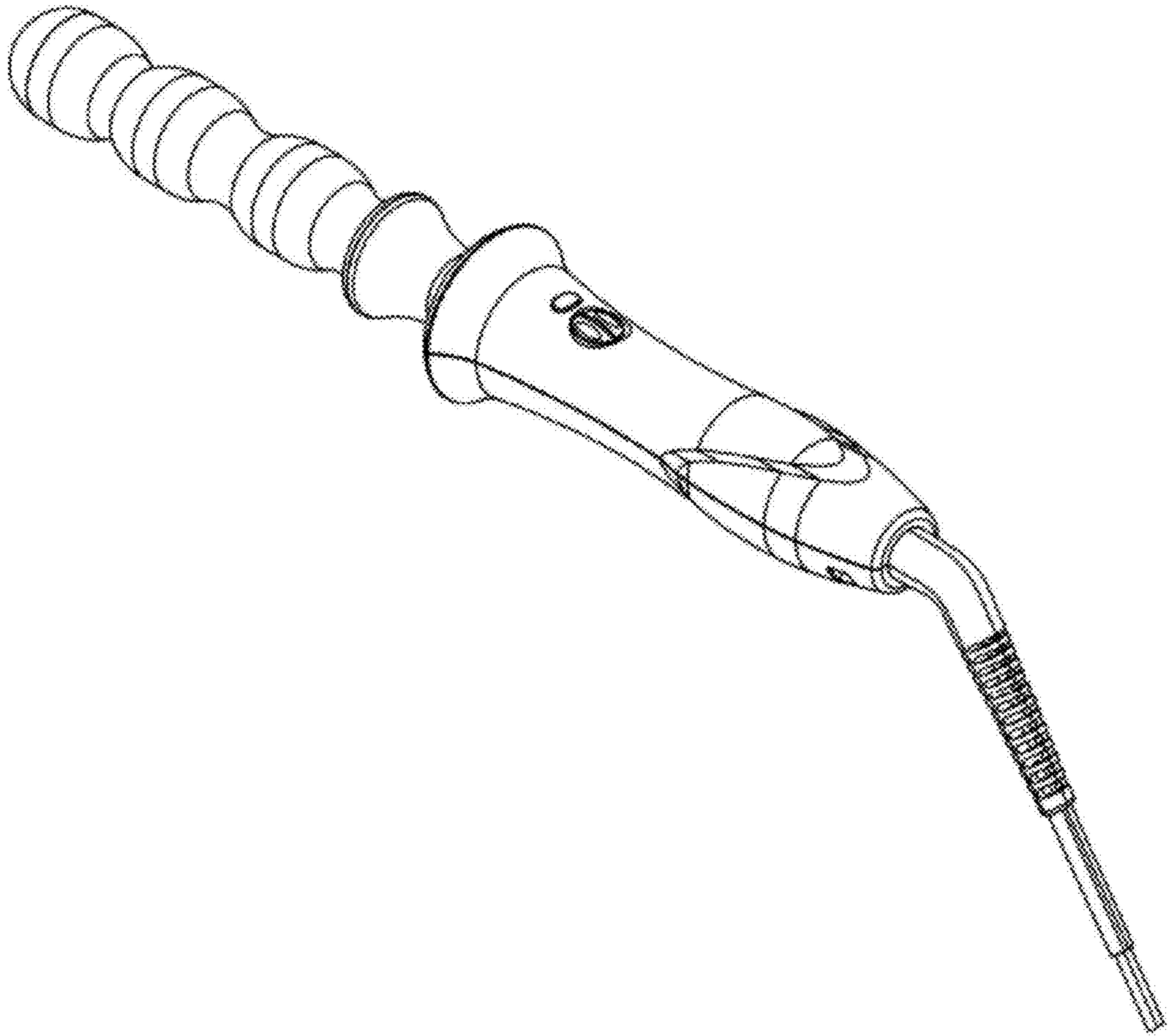

FIG. 1

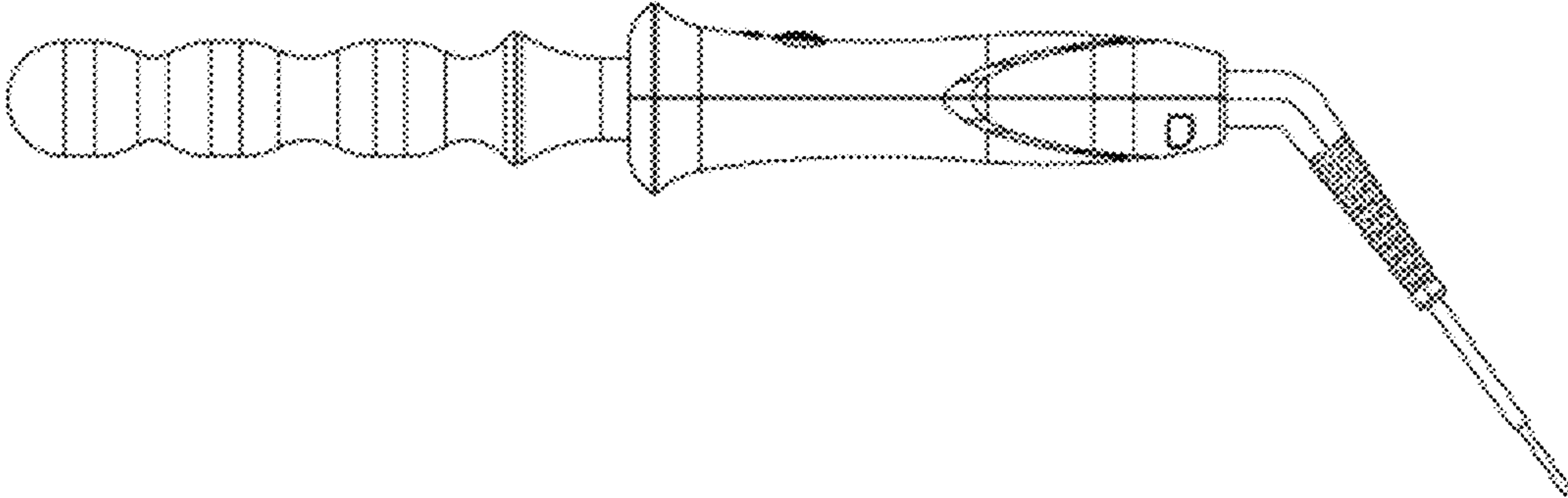

FIG. 2

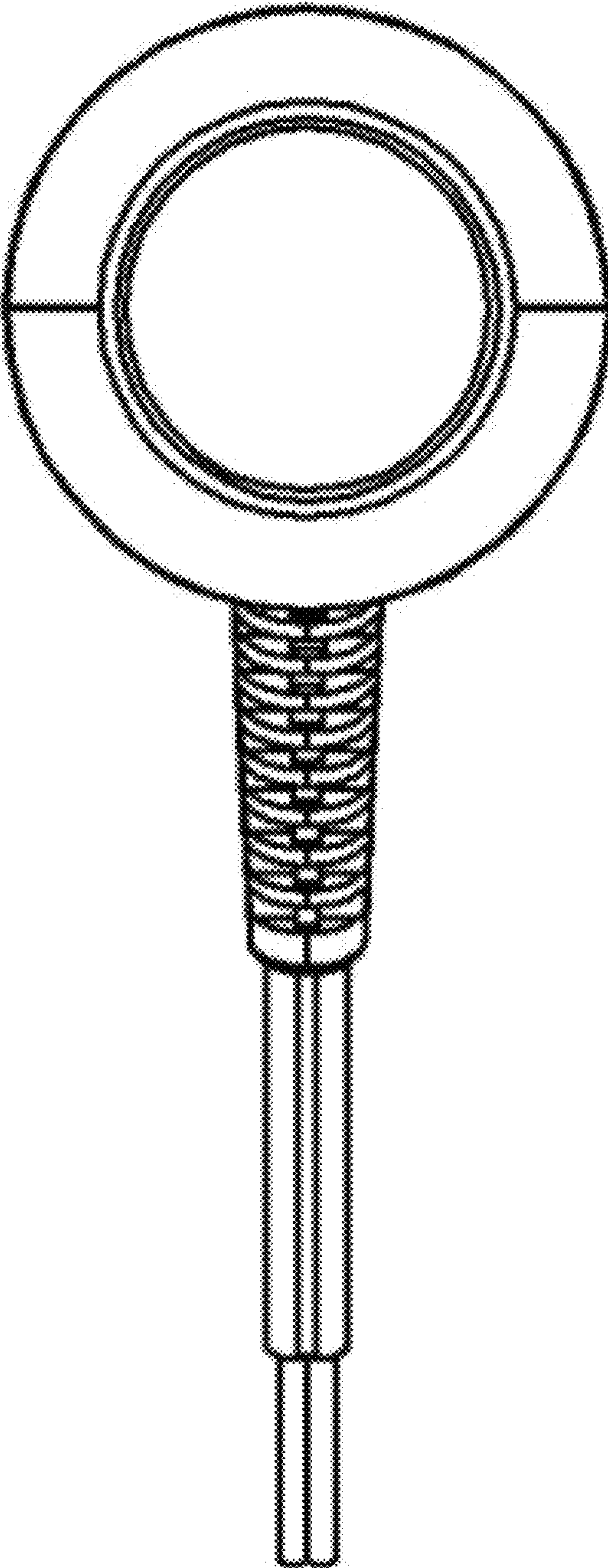

FIG. 3

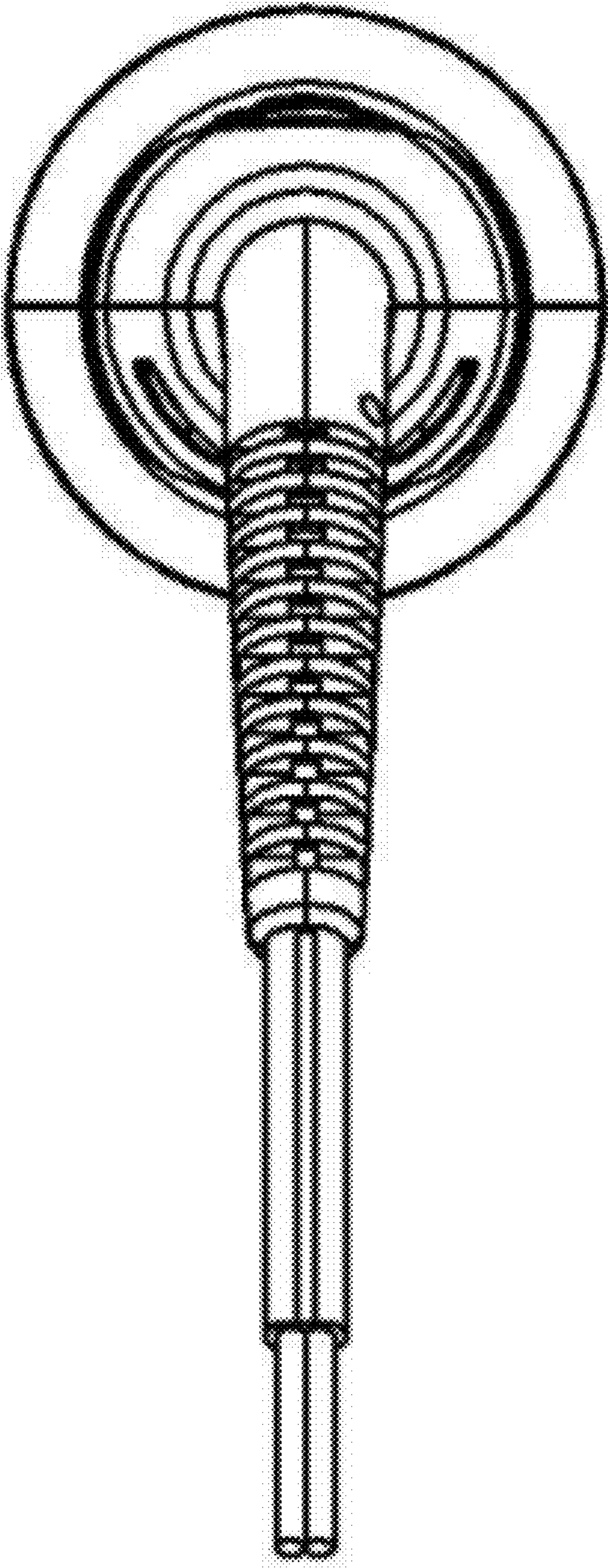

FIG. 4

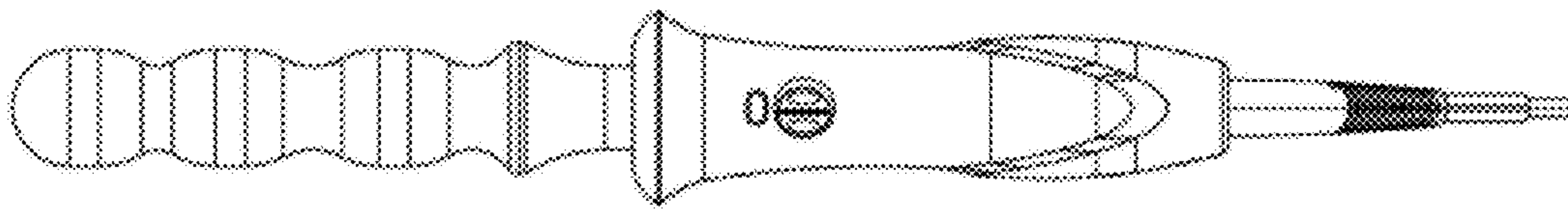

FIG. 5

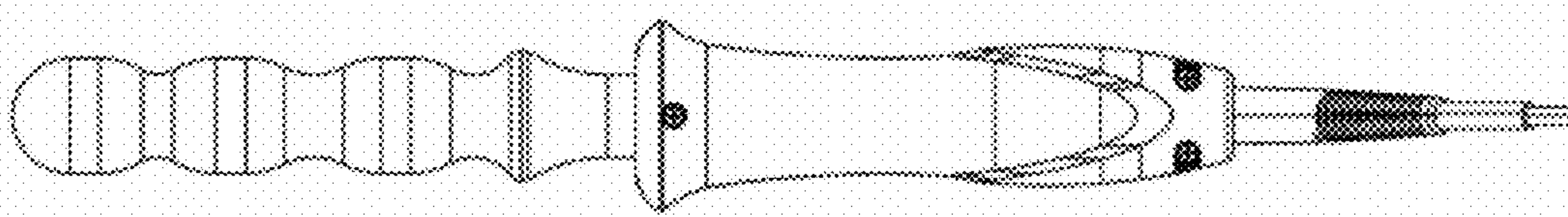

FIG. 6

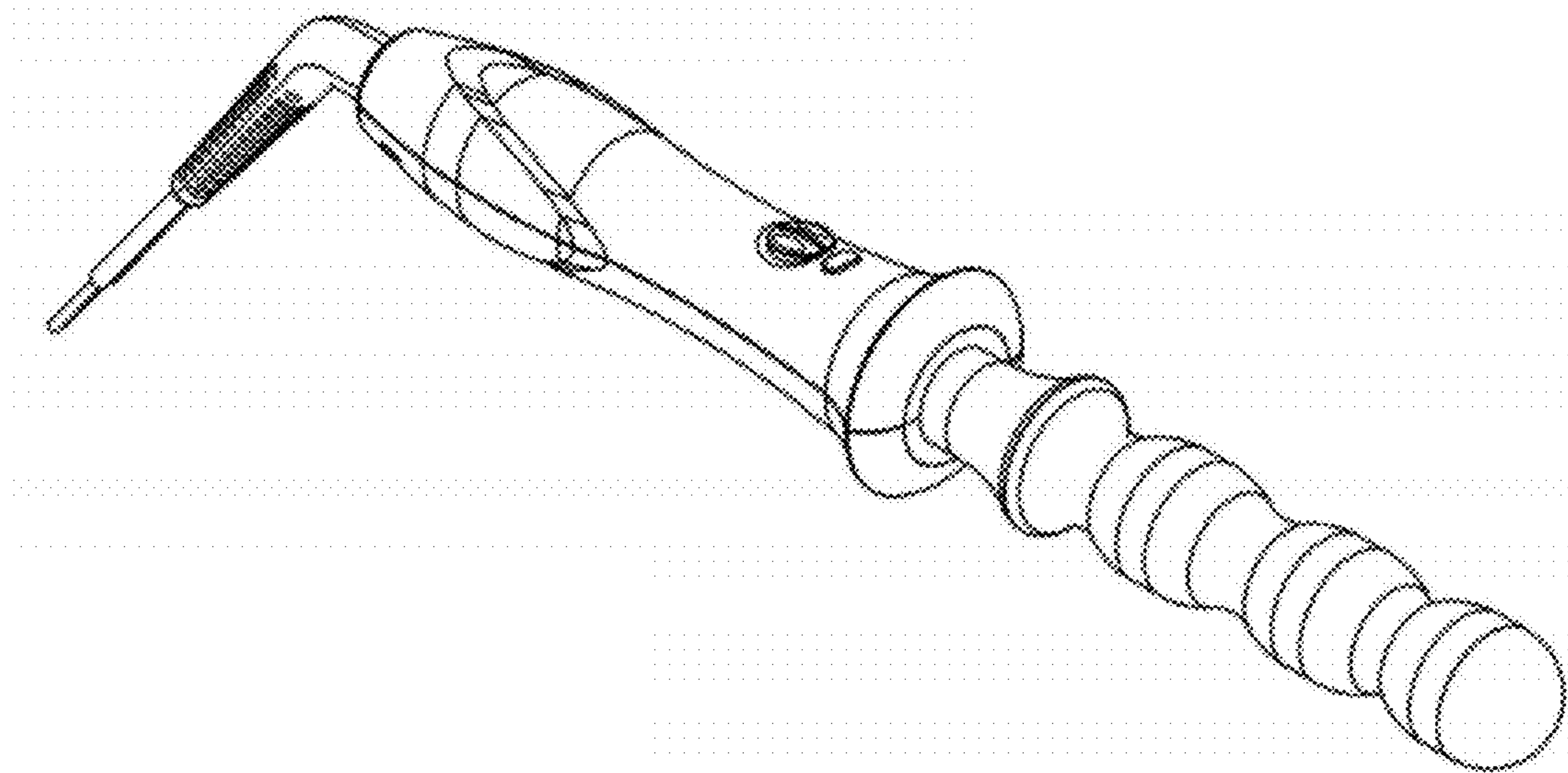

FIG. 7