



US00D672491S

(12) **United States Design Patent**
Shin et al.

(10) **Patent No.:** **US D672,491 S**
(45) **Date of Patent:** **** Dec. 11, 2012**

(54) **HEAD FOR STREETLIGHT**

(75) Inventors: **Daekee Shin**, Seoul (KR); **Yongduk Cha**, Gyeonggi-do (KR); **Jeewook Ha**, Seoul (KR)

(73) Assignee: **LG Electronics Inc.**, Seoul (KR)

(**) Term: **14 Years**

(21) Appl. No.: **29/418,213**

(22) Filed: **Apr. 13, 2012**

(30) **Foreign Application Priority Data**

Oct. 21, 2011 (KR) 30-2011-0043990

(51) **LOC (9) Cl.** **26-05**

(52) **U.S. Cl.** **D26/71**

(58) **Field of Classification Search** D26/61,
D26/63, 65, 67-71, 85, 92; 362/249.01-249.06,
362/294, 373, 431

See application file for complete search history.

(56) **References Cited**

U.S. PATENT DOCUMENTS

2,916,609 A * 12/1959 Freier et al. 362/374
D195,583 S * 7/1963 Phillips D26/71
D209,081 S * 10/1967 Netland D26/71
D323,897 S * 2/1992 Compton D26/24

D468,046 S * 12/2002 Bernard et al. D26/85
D608,040 S * 1/2010 Guercio D26/71
D609,381 S * 2/2010 Laporte D26/71
7,922,372 B2 * 4/2011 Li 362/373
8,007,142 B2 * 8/2011 Ku et al. 362/368
D648,473 S * 11/2011 Lin et al. D26/71
D648,884 S * 11/2011 Tortel D26/71
D660,496 S * 5/2012 Akdag et al. D26/71

* cited by examiner

Primary Examiner — Clare E Heflin

(74) *Attorney, Agent, or Firm* — Morgan, Lewis & Bockius LLP

(57) **CLAIM**

The ornamental design for a head for streetlight, as shown and described.

DESCRIPTION

FIG. 1 is a perspective view of a head for streetlight showing our new design;
FIG. 2 is a front view thereof;
FIG. 3 is a rear view thereof;
FIG. 4 is a left side view thereof where the right side view is a mirror image;
FIG. 5 is a top plan view thereof;
FIG. 6 is a bottom plan view thereof; and,
FIG. 7 is a perspective view showing an example of the usage of the subject design.

The broken lines are for illustrative purposes only and form no part of the claimed design.

1 Claim, 6 Drawing Sheets

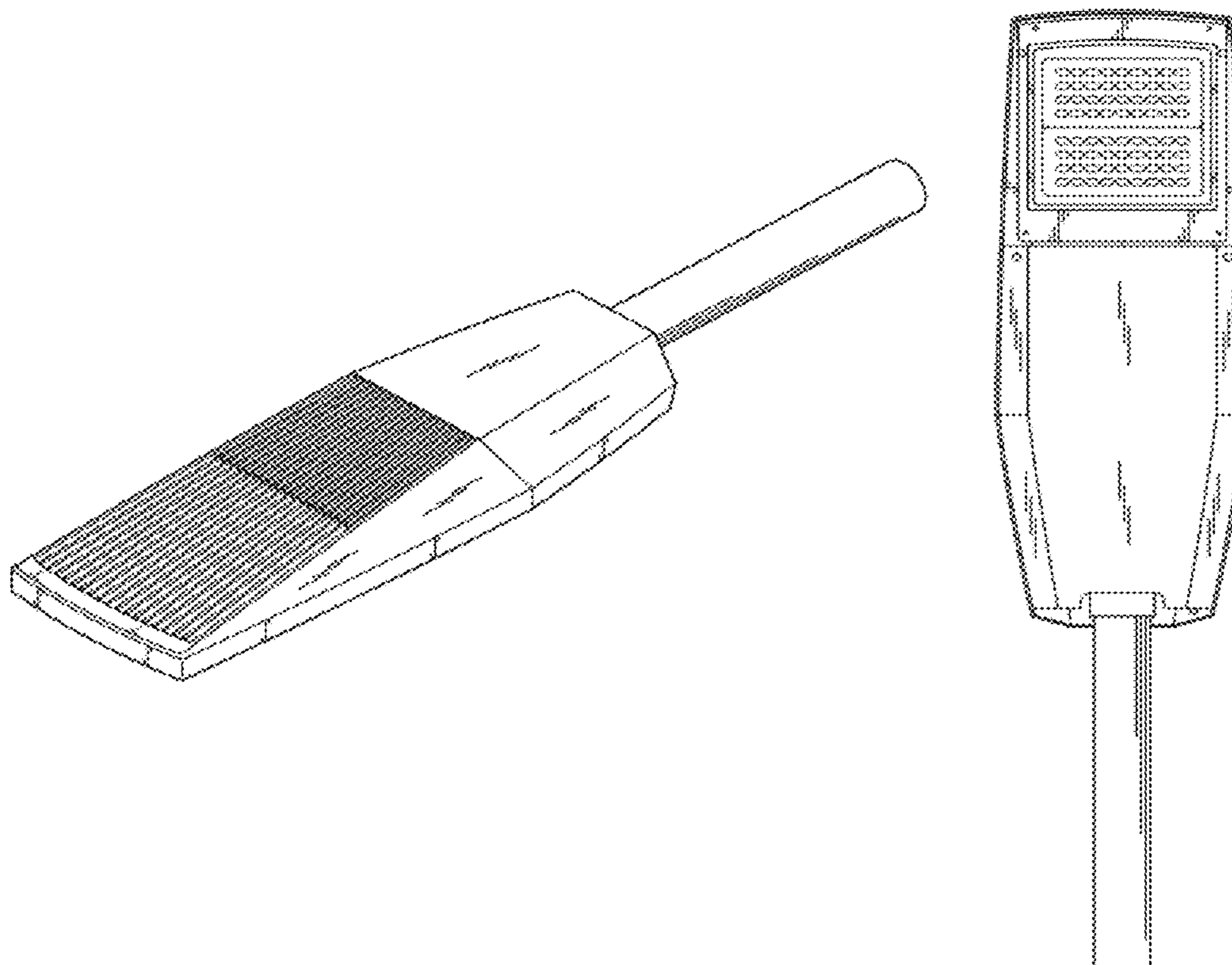

FIG. 1

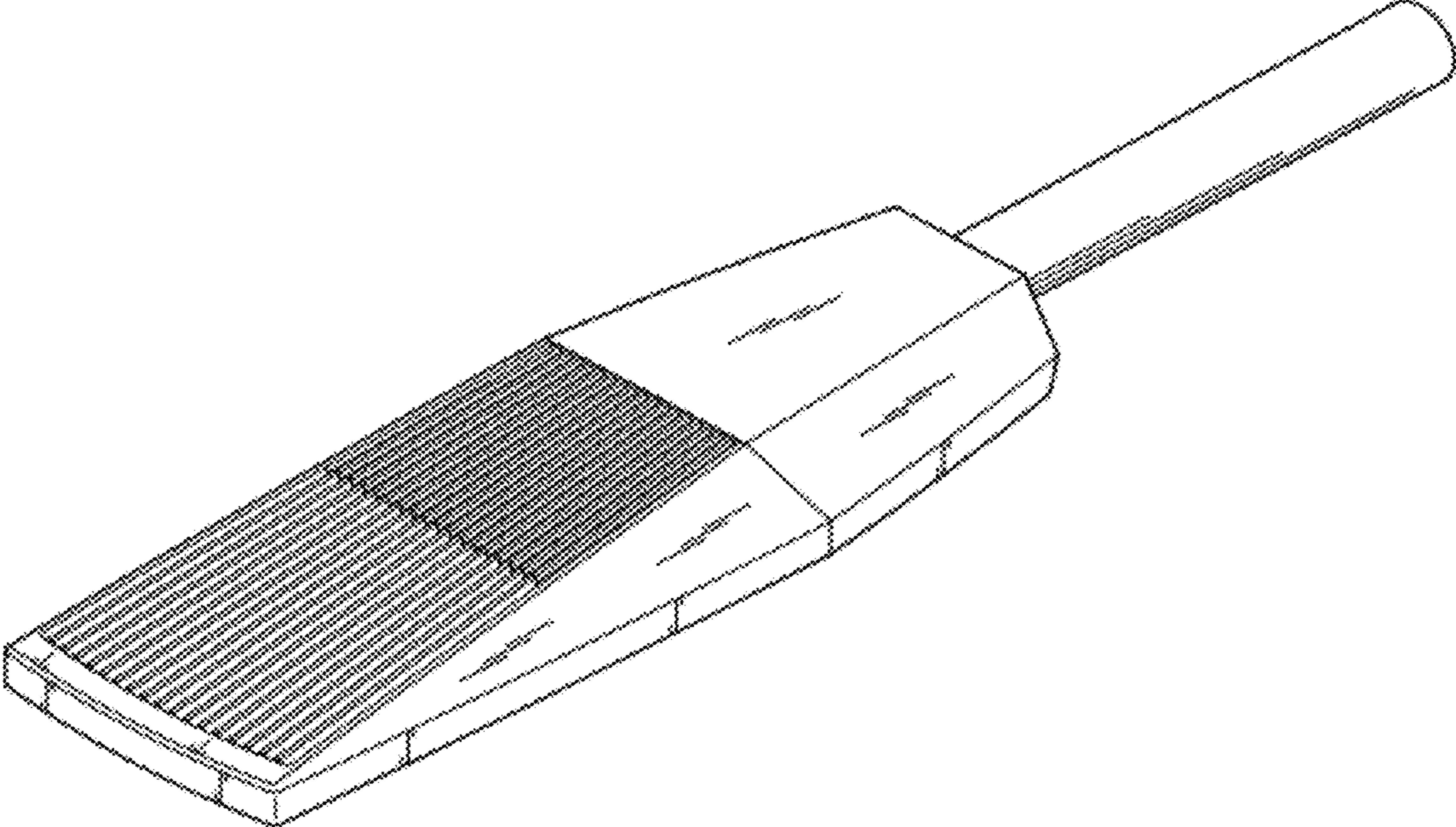

FIG. 2

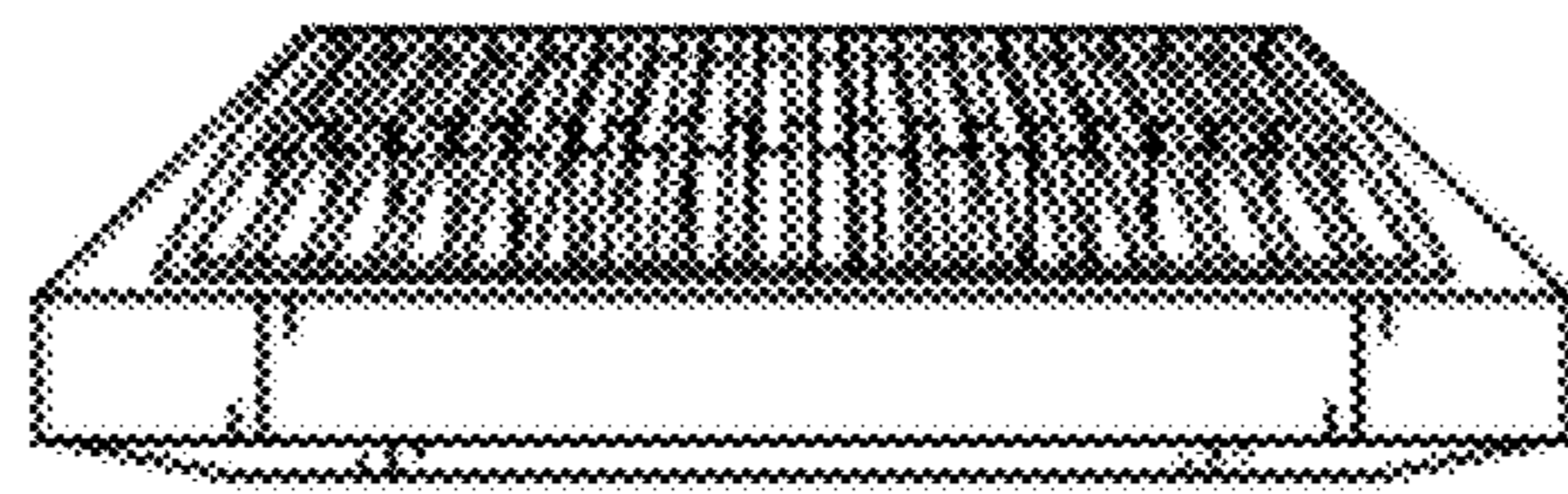

FIG. 3

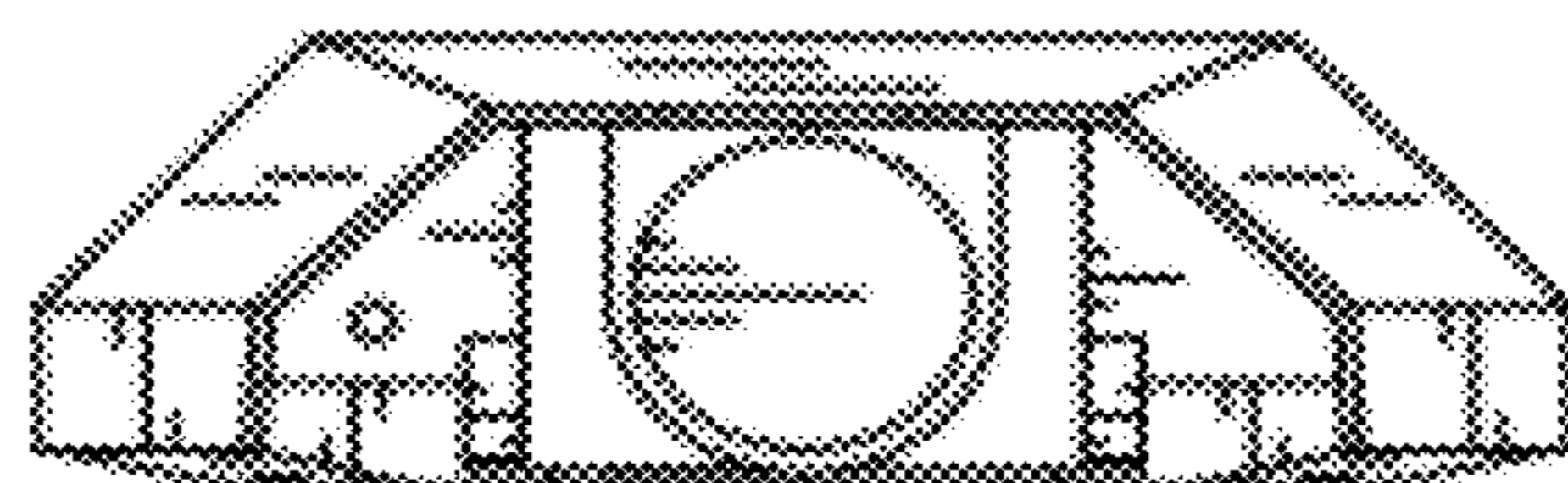

FIG. 4

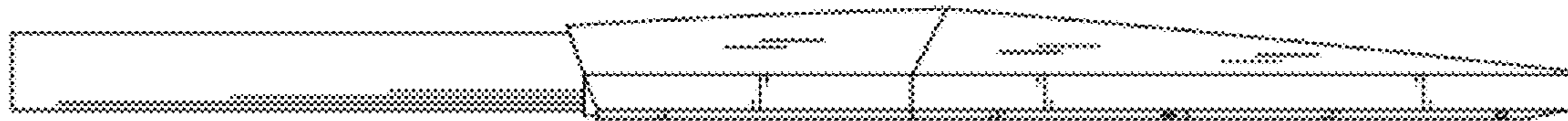

FIG. 5

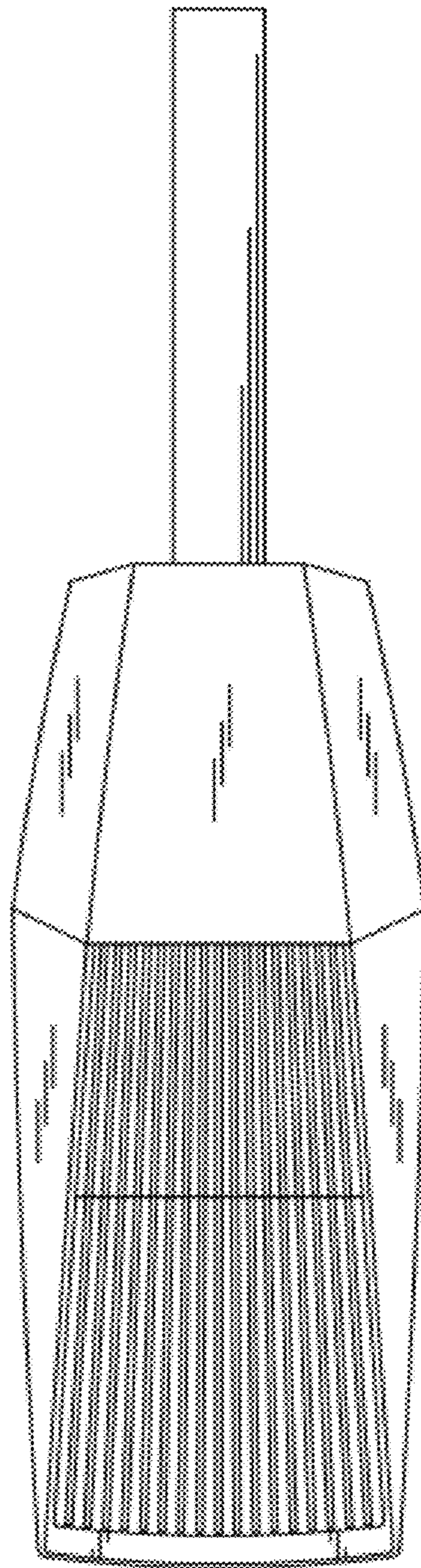

FIG. 6

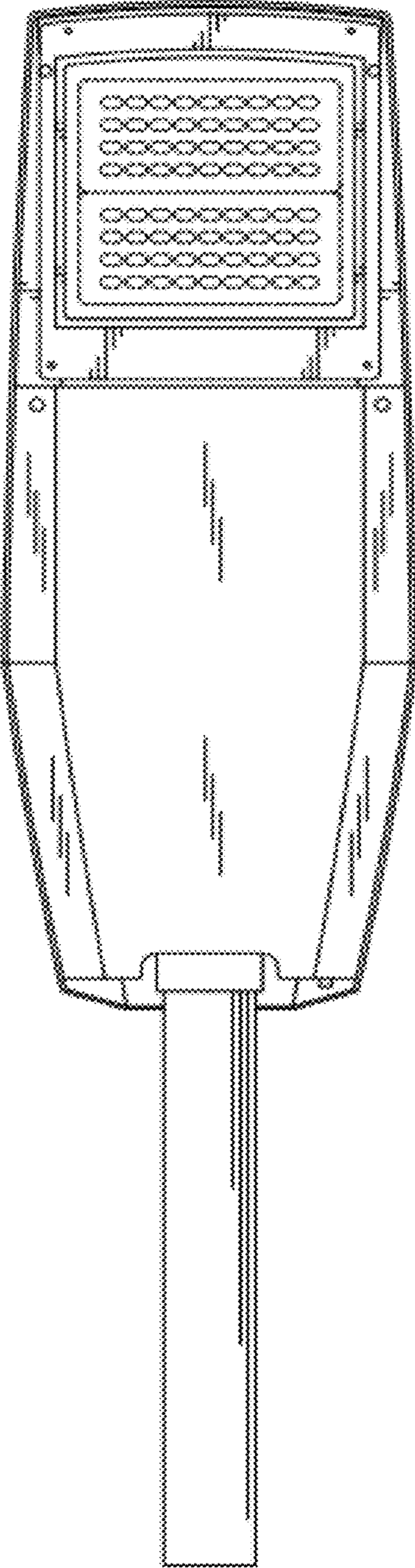

FIG. 7

