



US00D672420S

(12) **United States Design Patent**
Rominger

(10) **Patent No.:** **US D672,420 S**

(45) **Date of Patent:** **** Dec. 11, 2012**

(54) **WATER HAMMOCK**

(75) Inventor: **Patrick L. Rominger**, Wichita Falls, TX
(US)

(73) Assignee: **TRC Recreation, LP**, Wichita Falls, TX
(US)

(**) Term: **14 Years**

(21) Appl. No.: **29/416,985**

(22) Filed: **Mar. 29, 2012**

(51) **LOC (9) Cl.** **29-02**

(52) **U.S. Cl.** **D21/803**

(58) **Field of Classification Search** D21/769-770,
D21/801, 803, 809; 114/253, 345-346; 441/35,
441/66, 40-42, 129-132; 472/128-129;
D12/5, 6, 316; D6/595-601

See application file for complete search history.

(56) **References Cited**

U.S. PATENT DOCUMENTS

3,161,897	A	12/1964	Hill	
4,286,344	A	9/1981	Ikeda	
D273,966	S	5/1984	Piel	
4,634,393	A	1/1987	Wood	
D296,348	S	* 6/1988	Terrien	D21/809
D306,473	S	* 3/1990	Scheurer	D21/809
D315,187	S	* 3/1991	Thomas	D21/809
D315,188	S	* 3/1991	Thomas	D21/809

D315,189	S	* 3/1991	Thomas	D21/809
5,273,473	A	12/1993	Allen	
D353,494	S	12/1994	Beger	
D370,956	S	6/1996	Pery	
D389,359	S	* 1/1998	Nowak	D6/601
D466,749	S	* 12/2002	O'Quinn	D6/601
D485,724	S	* 1/2004	Morikawa	D6/601
D494,128	S	* 8/2004	Berger	D12/416
6,971,715	B2	* 12/2005	Hankins	297/219.11
D576,439	S	* 9/2008	Yaroshenko	D6/601
D604,549	S	* 11/2009	Yaroshenko	D6/601

* cited by examiner

Primary Examiner — Zenia Bennett

(74) *Attorney, Agent, or Firm* — Scott T. Griggs; Griggs
Bergen LLP

(57) **CLAIM**

The ornamental design for a water hammock, as shown and
described.

DESCRIPTION

FIG. 1 is a front perspective view of a water hammock which
illustrates my new design;

FIG. 2 is a top plan view thereof;

FIG. 3 is a bottom plan view thereof;

FIG. 4 is a left side elevational view thereof;

FIG. 5 is a right side elevational view thereof;

FIG. 6 is a front elevation view thereof; and,

FIG. 7 is a rear elevation view thereof.

1 Claim, 5 Drawing Sheets

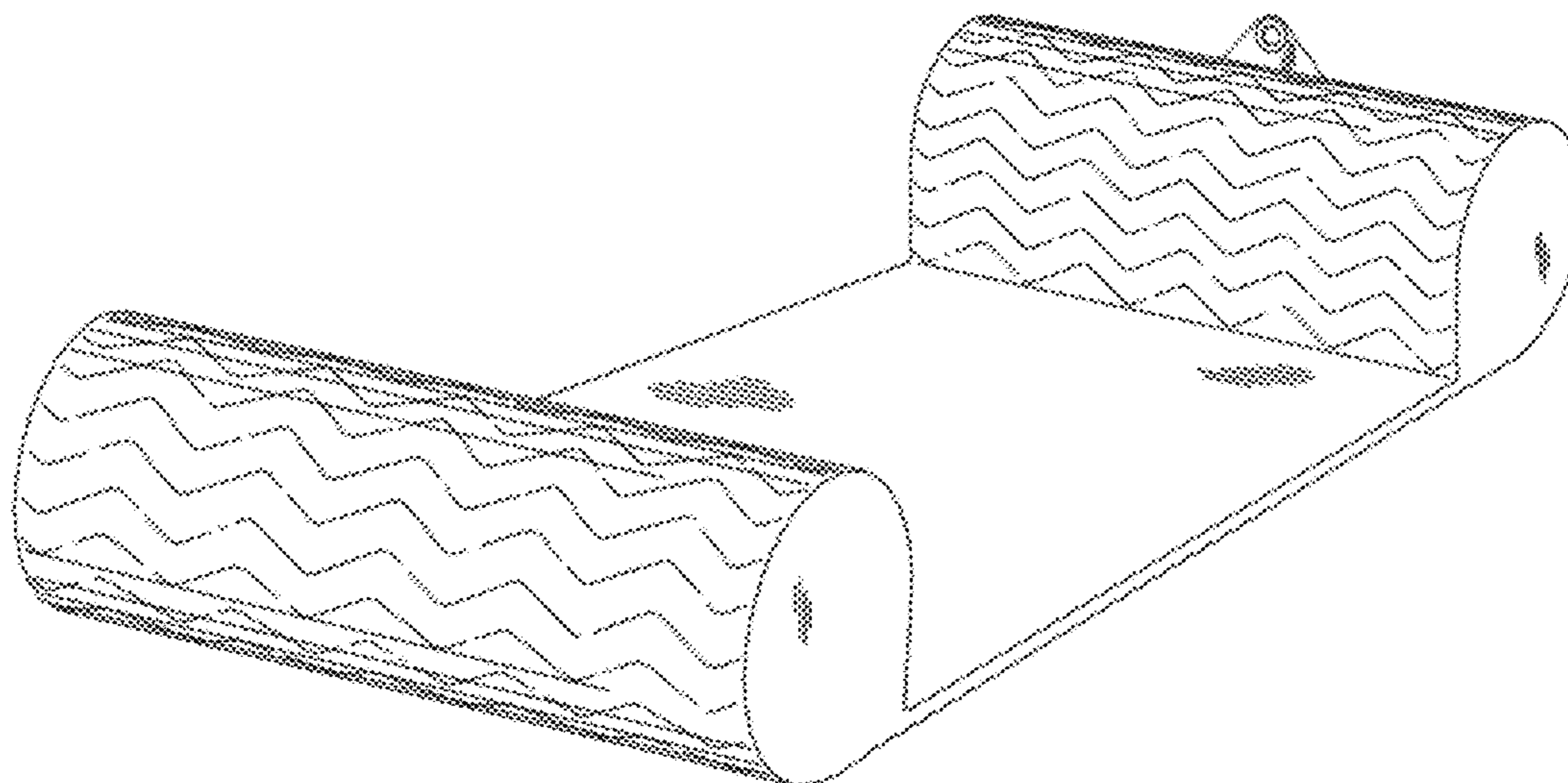

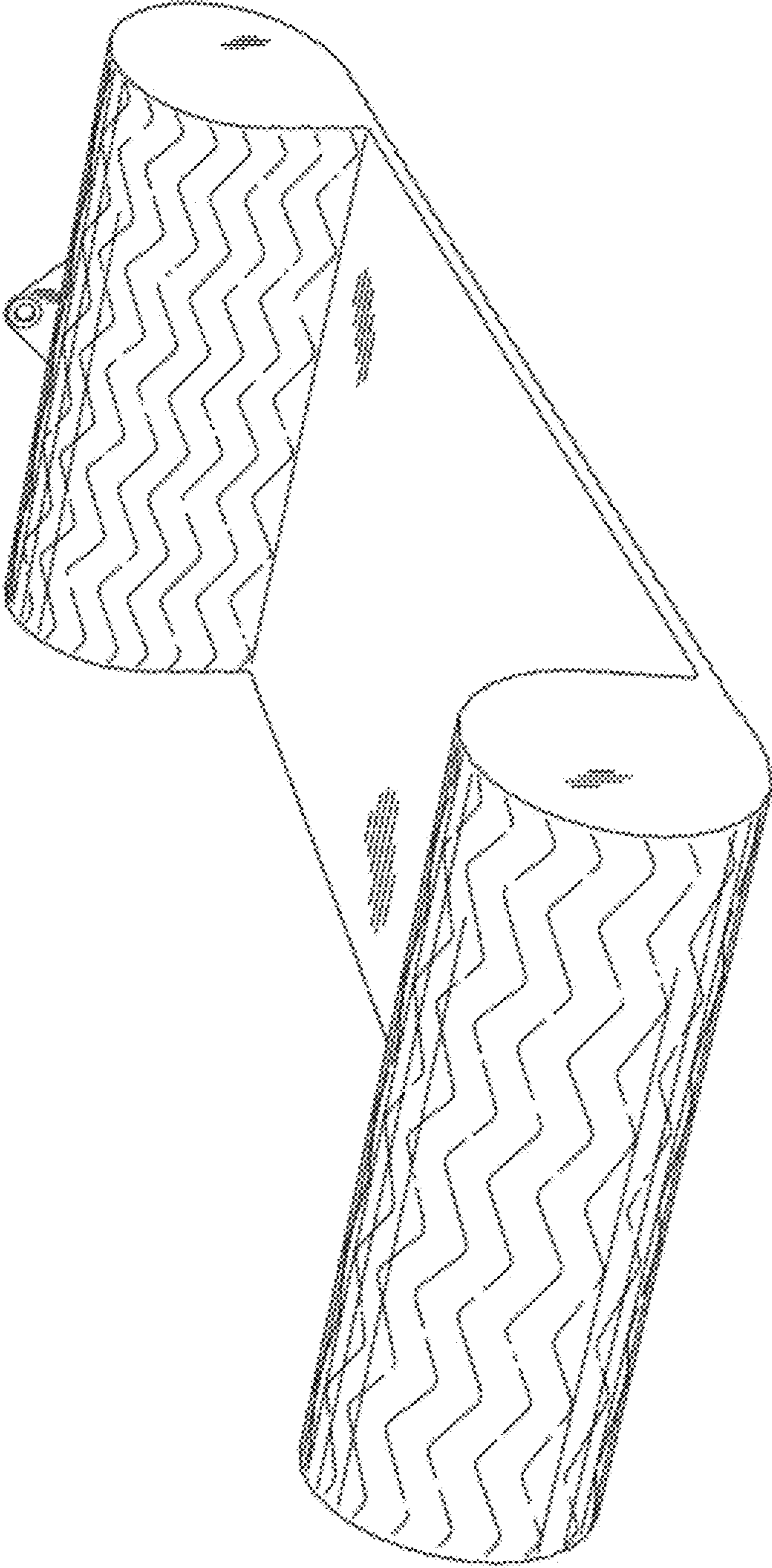

FIG. 1

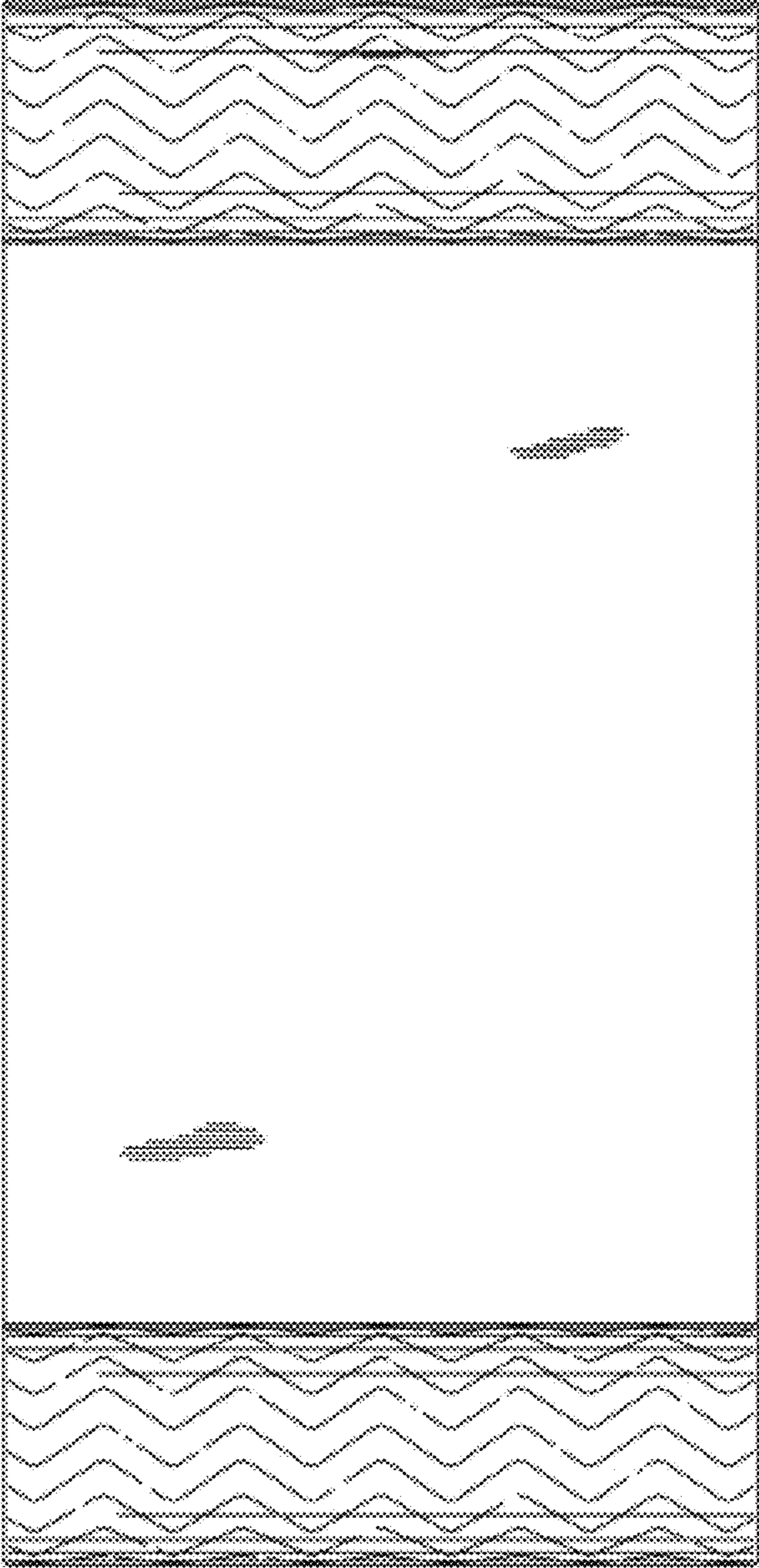

FIG. 2

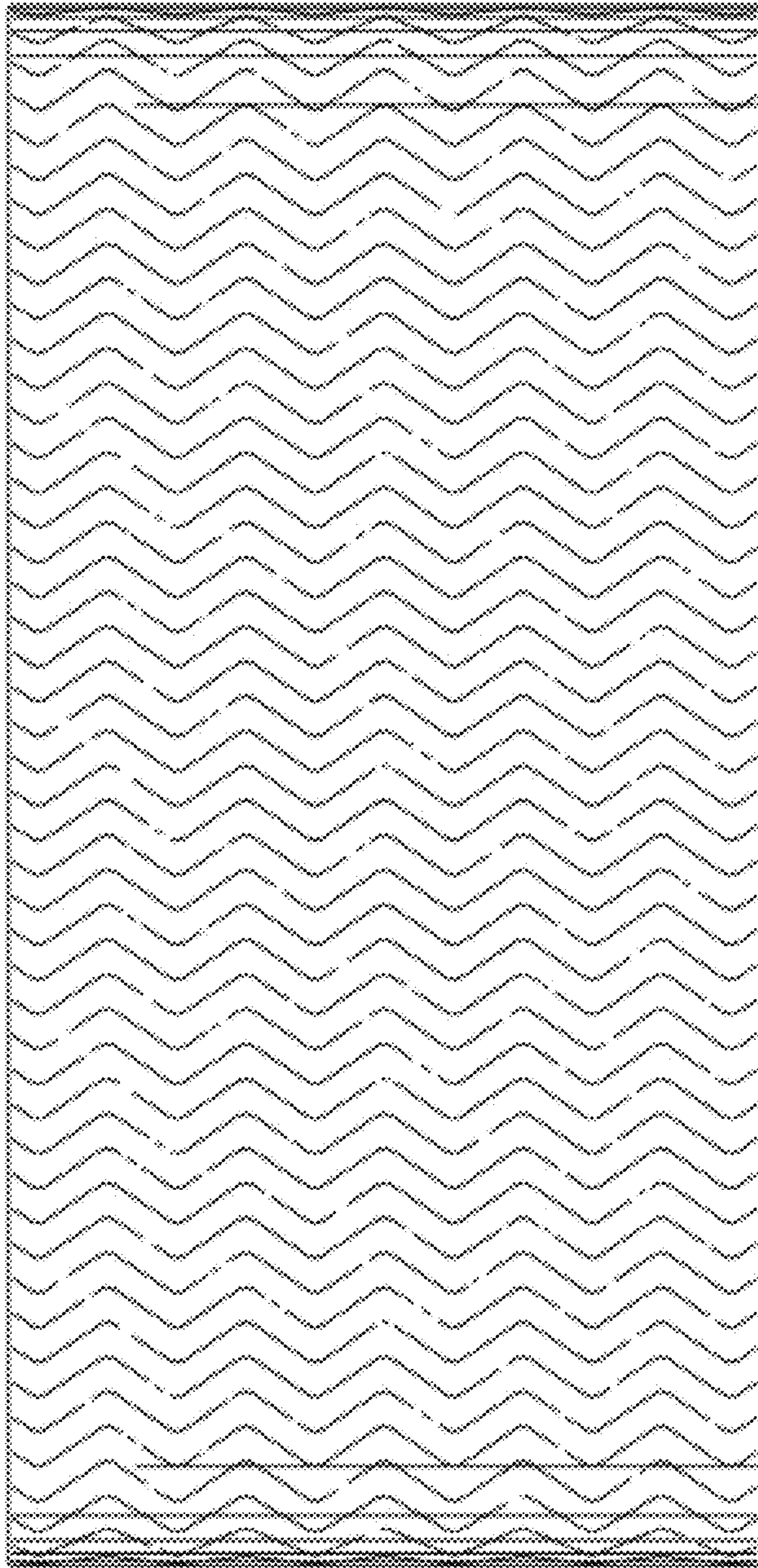

FIG. 3

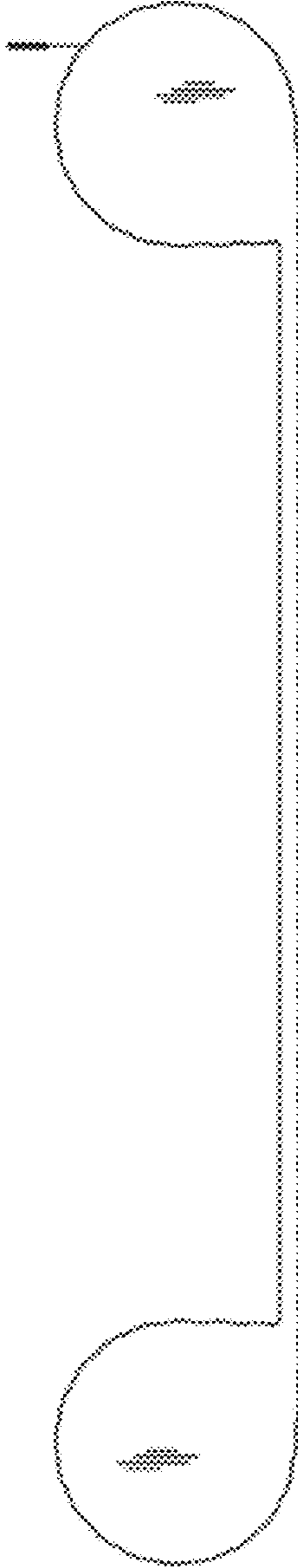

FIG. 4

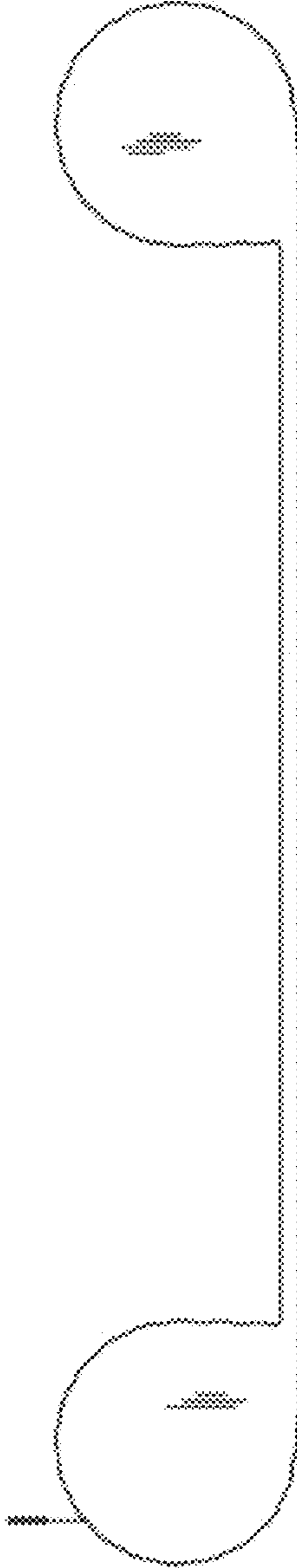

FIG. 5

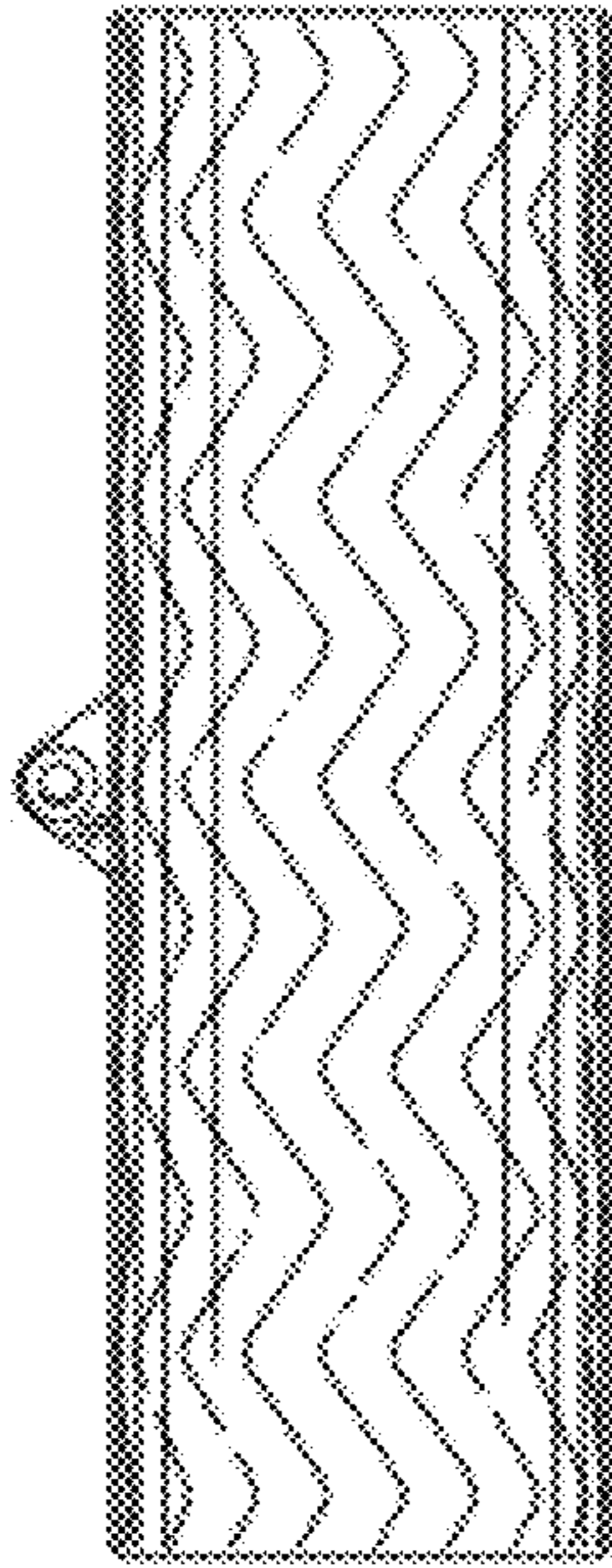

FIG. 6

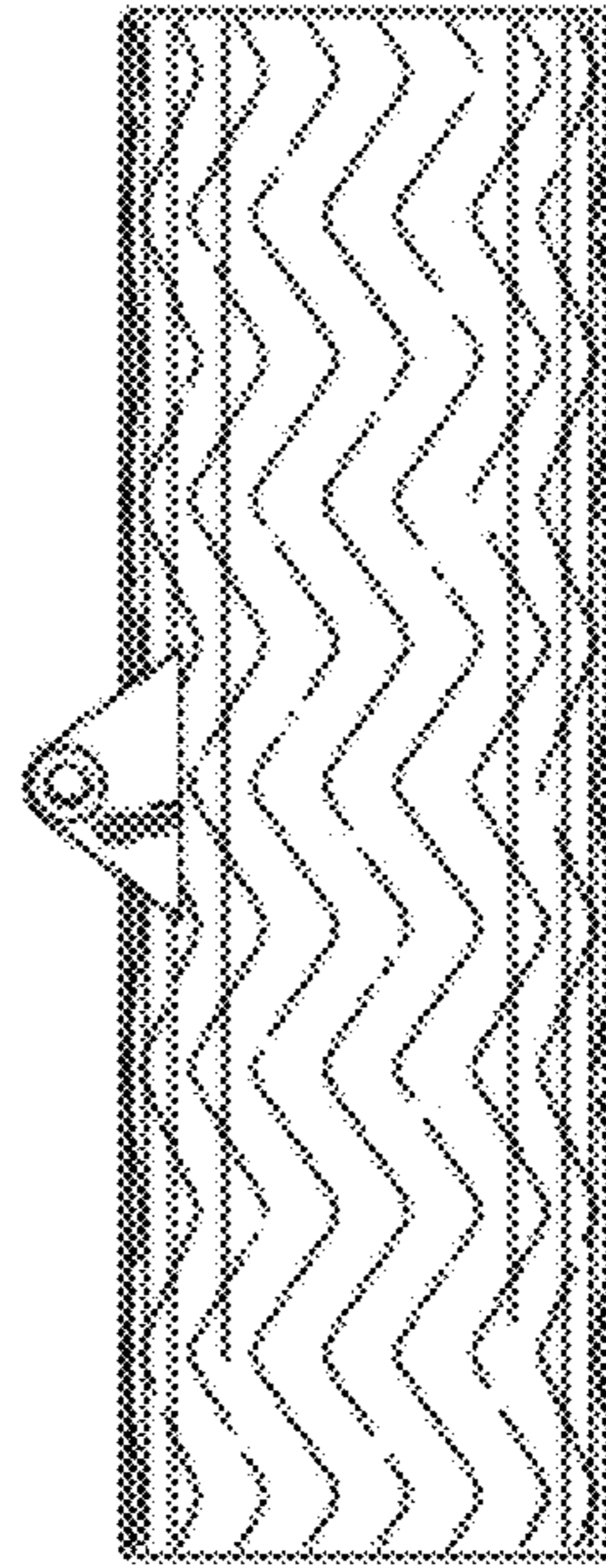

FIG. 7