



US00D672375S

(12) **United States Design Patent**
Lee et al.

(10) **Patent No.:** **US D672,375 S**
(45) **Date of Patent:** **** Dec. 11, 2012**

(54) **REFRIGERATOR**

(75) Inventors: **Hangbok Lee**, Gyeonggi-do (KR);
Hyokku Kwon, Seoul (KR); **Eunjoon Lee**, Gyeonggi-do (KR); **Hyosung Kim**, Seoul (KR)

(73) Assignee: **LG Electronics Inc.**, Seoul (KR)

(**) Term: **14 Years**

(21) Appl. No.: **29/405,480**

(22) Filed: **Nov. 2, 2011**

(30) **Foreign Application Priority Data**

May 4, 2011 (KR) 30-2011-0018450

(51) **LOC (9) Cl.** **21-02**

(52) **U.S. Cl.** **D15/86**

(58) **Field of Classification Search** D15/79,
D15/81, 85-88, 91; 62/3.6-3.64, 293, 331,
62/371, 440-445, 468; 312/112-119, 236,
312/400-408

See application file for complete search history.

(56) **References Cited**

U.S. PATENT DOCUMENTS

D190,453 S * 5/1961 Munz et al. D15/86
D615,564 S * 5/2010 Kristiansen et al. D15/86

D629,021 S * 12/2010 Cho et al. D15/85
D647,927 S * 11/2011 Lee et al. D15/85
D655,321 S * 3/2012 Lee et al. D15/86
D657,804 S * 4/2012 Lee et al. D15/86
D657,805 S * 4/2012 Cho et al. D15/86
D658,215 S * 4/2012 Seo et al. D15/86

* cited by examiner

Primary Examiner — Mitchell Siegel

(74) *Attorney, Agent, or Firm* — Birch, Stewart, Kolasch & Birch, LLP

(57) **CLAIM**

The ornamental design for a refrigerator, as shown and described.

DESCRIPTION

FIG. 1 is a perspective view of a refrigerator showing our new design;
FIG. 2 is a front view thereof;
FIG. 3 is a rear view thereof;
FIG. 4 is a left side view thereof;
FIG. 5 is a right side view thereof;
FIG. 6 is a top plan view thereof;
FIG. 7 is a bottom plan view thereof;
FIG. 8 is a bottom perspective view thereof; and,
FIG. 9 is a fragmented enlarged front elevational view showing a transparent portion around the periphery of each door, shown for clarity of illustration.

1 Claim, 9 Drawing Sheets

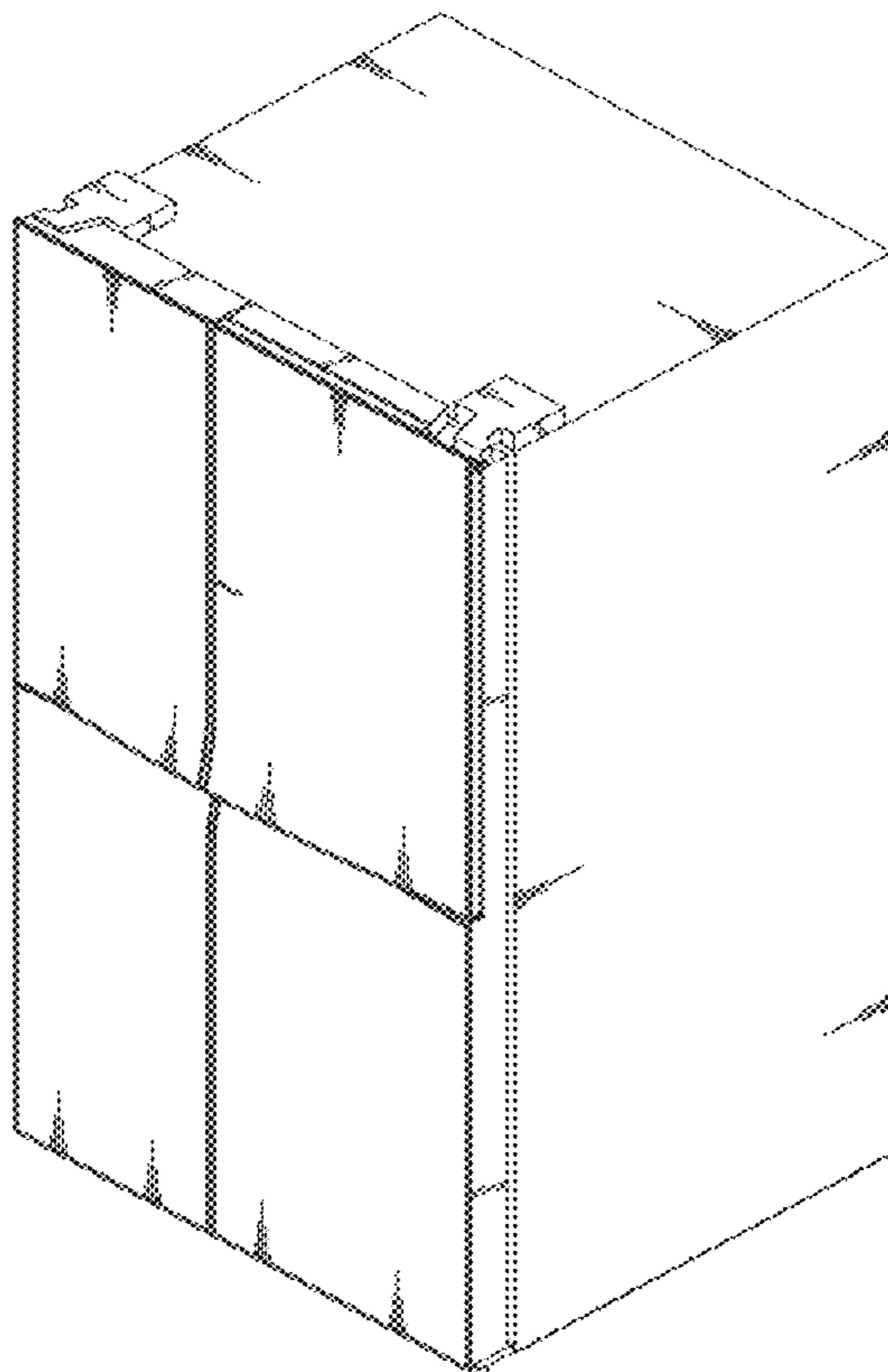

FIG. 1

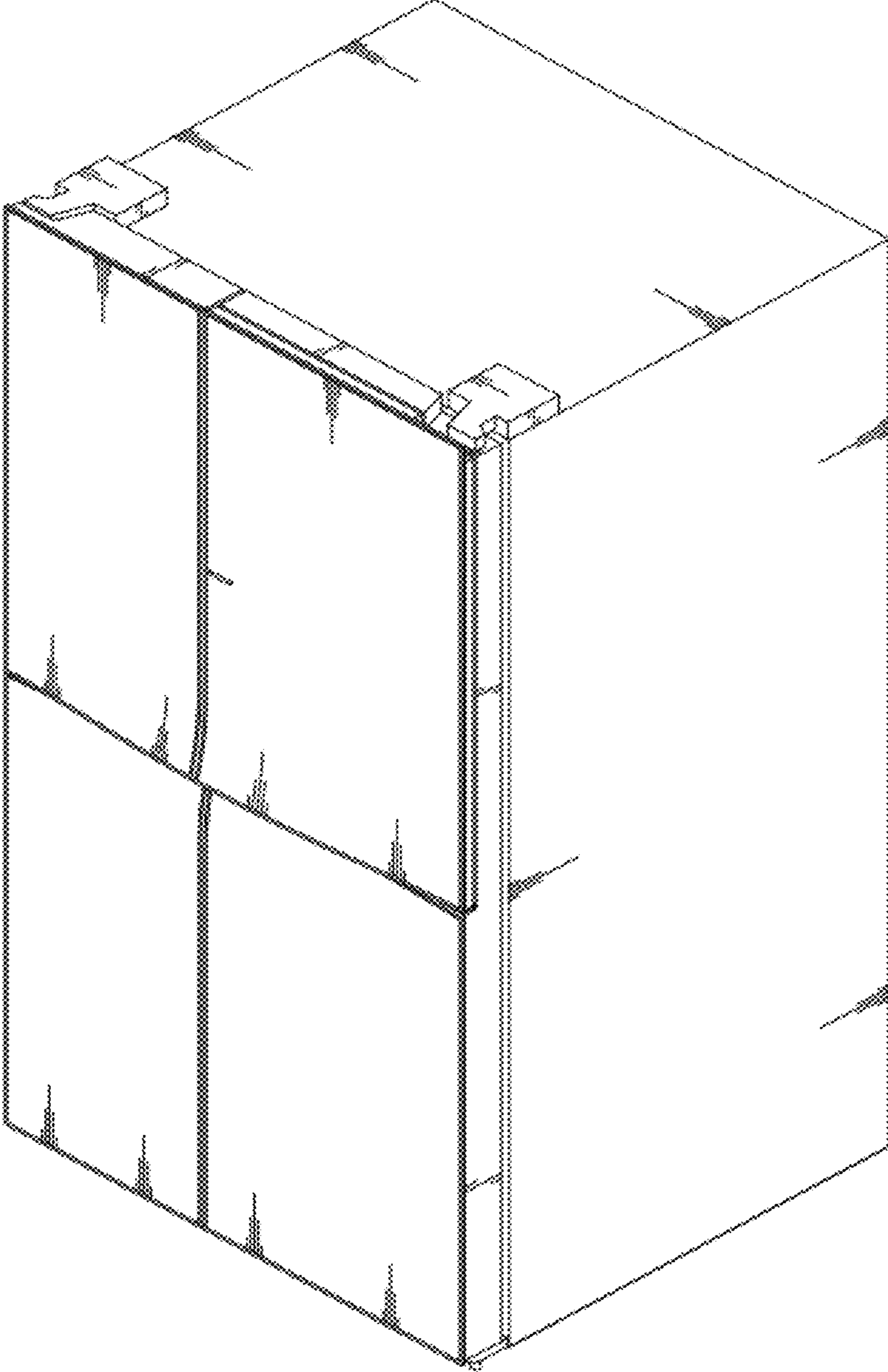

FIG. 2

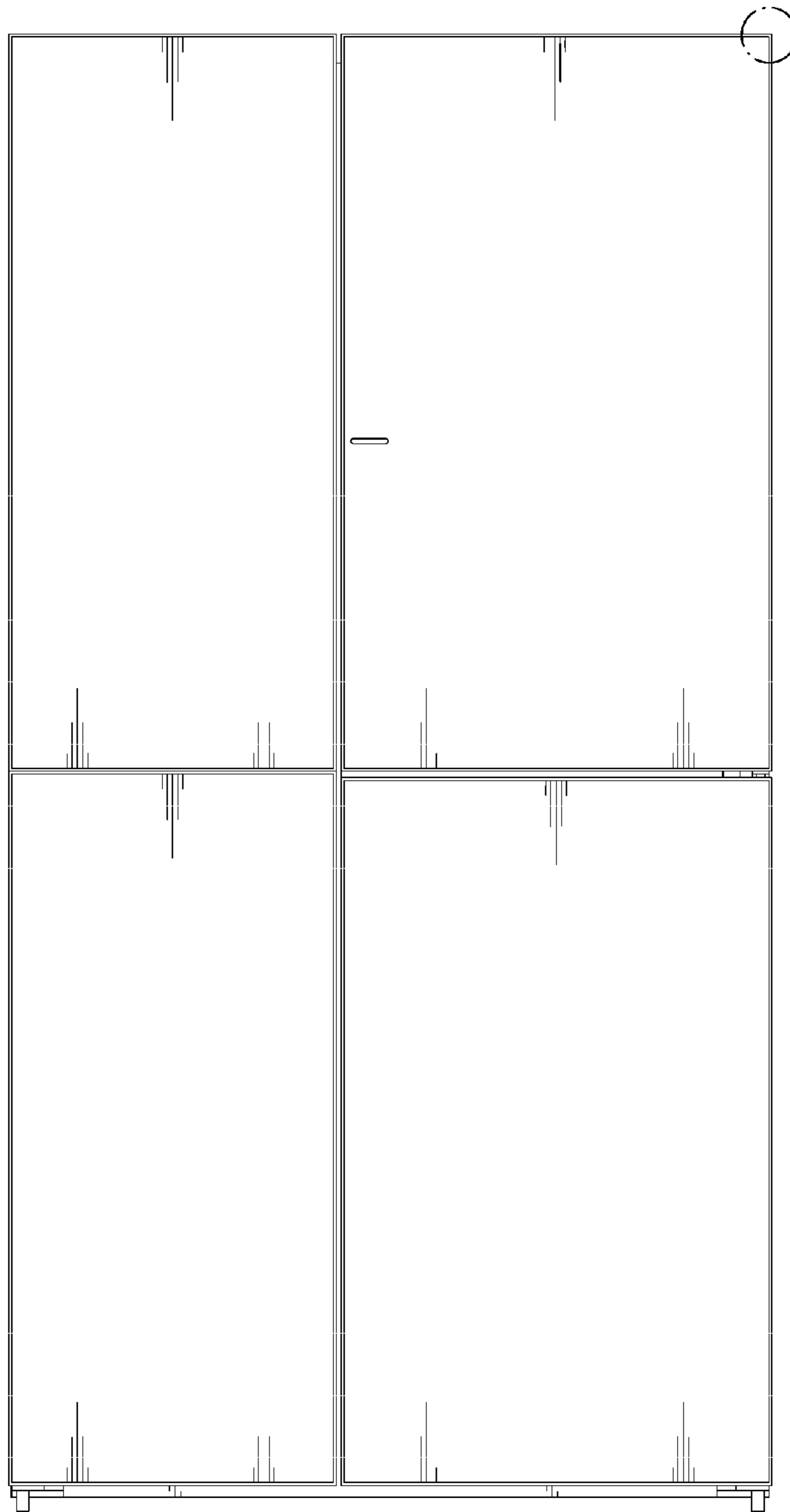

FIG. 3

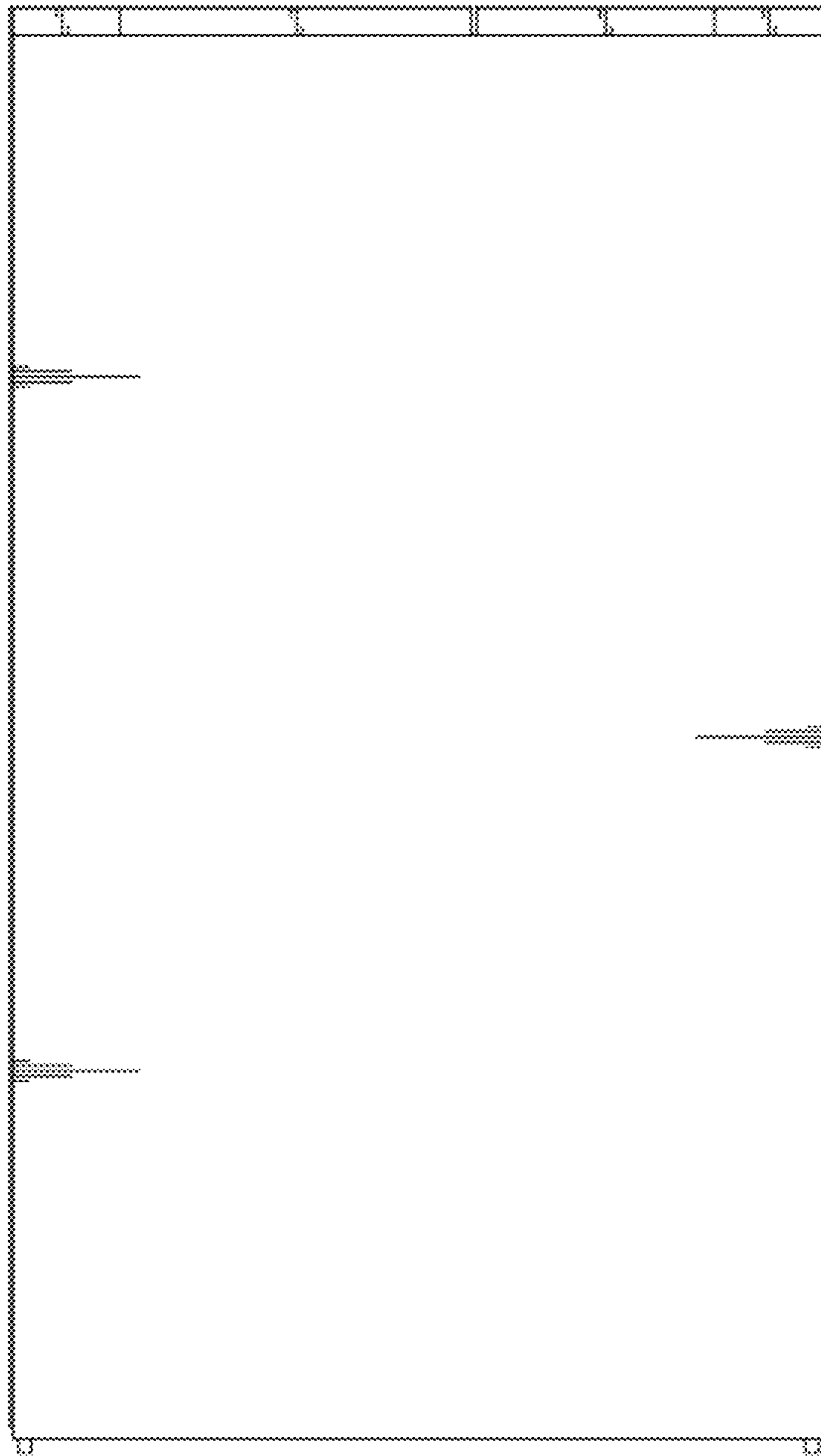

FIG. 4

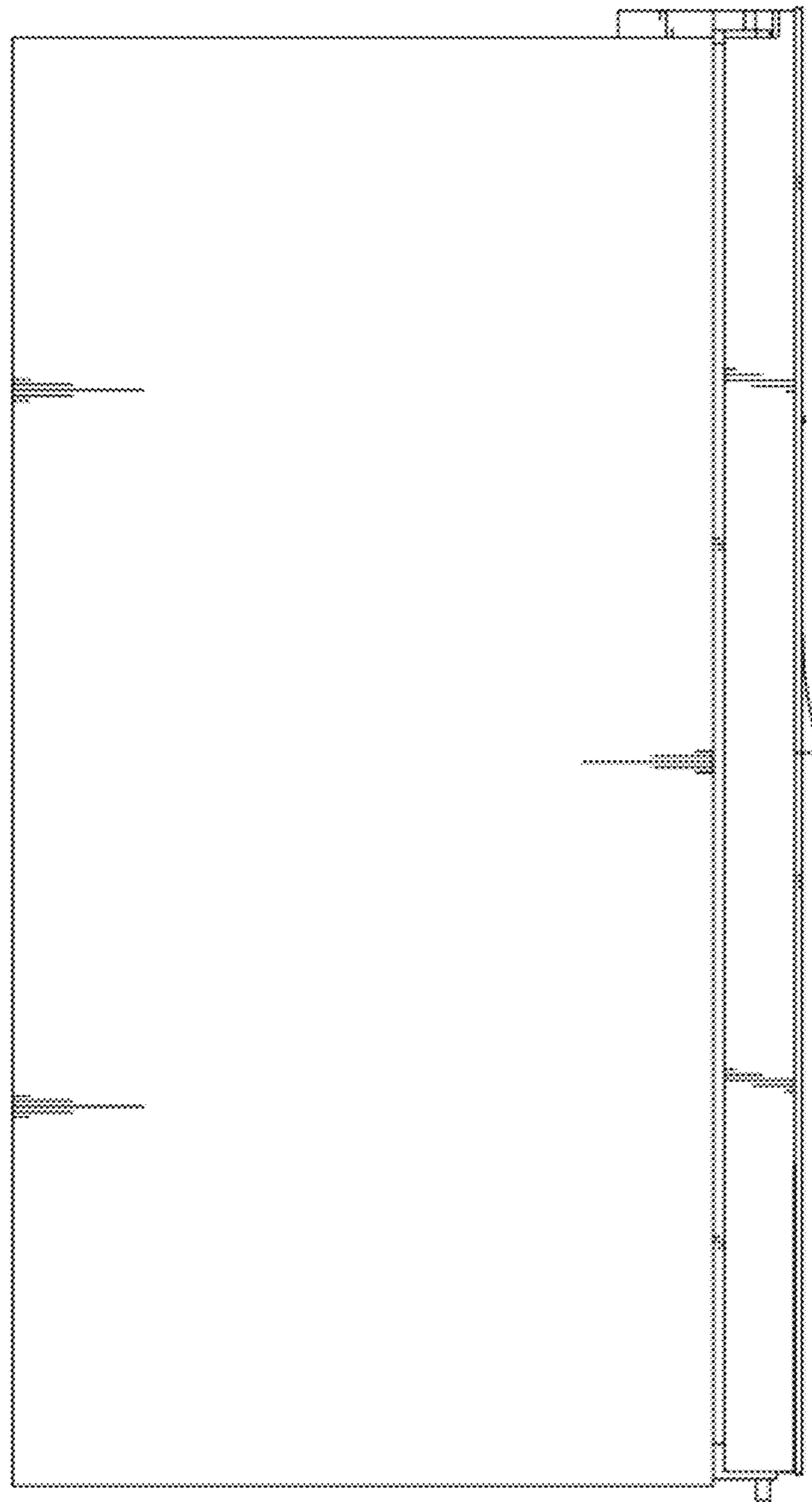

FIG. 5

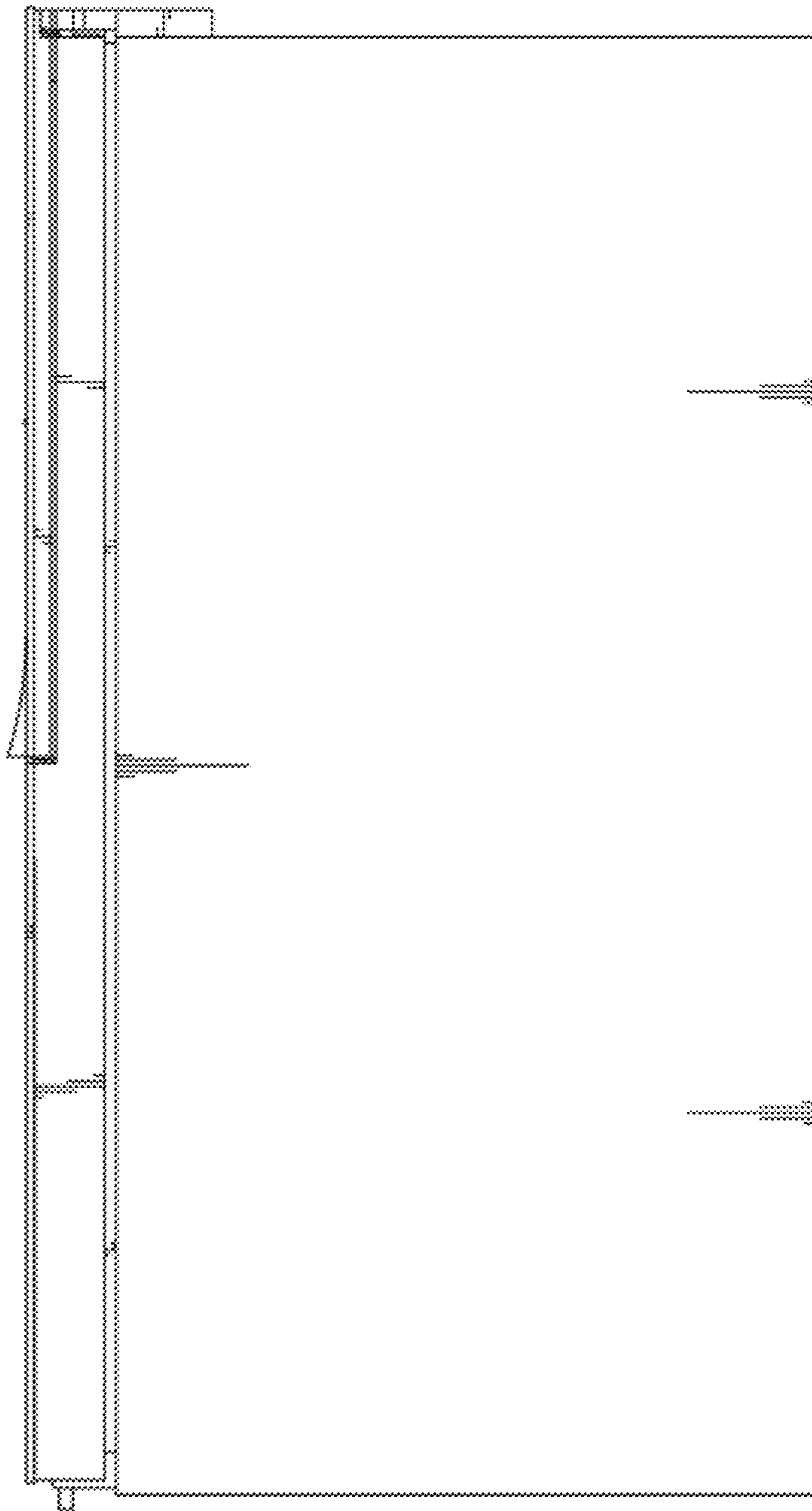

FIG. 6

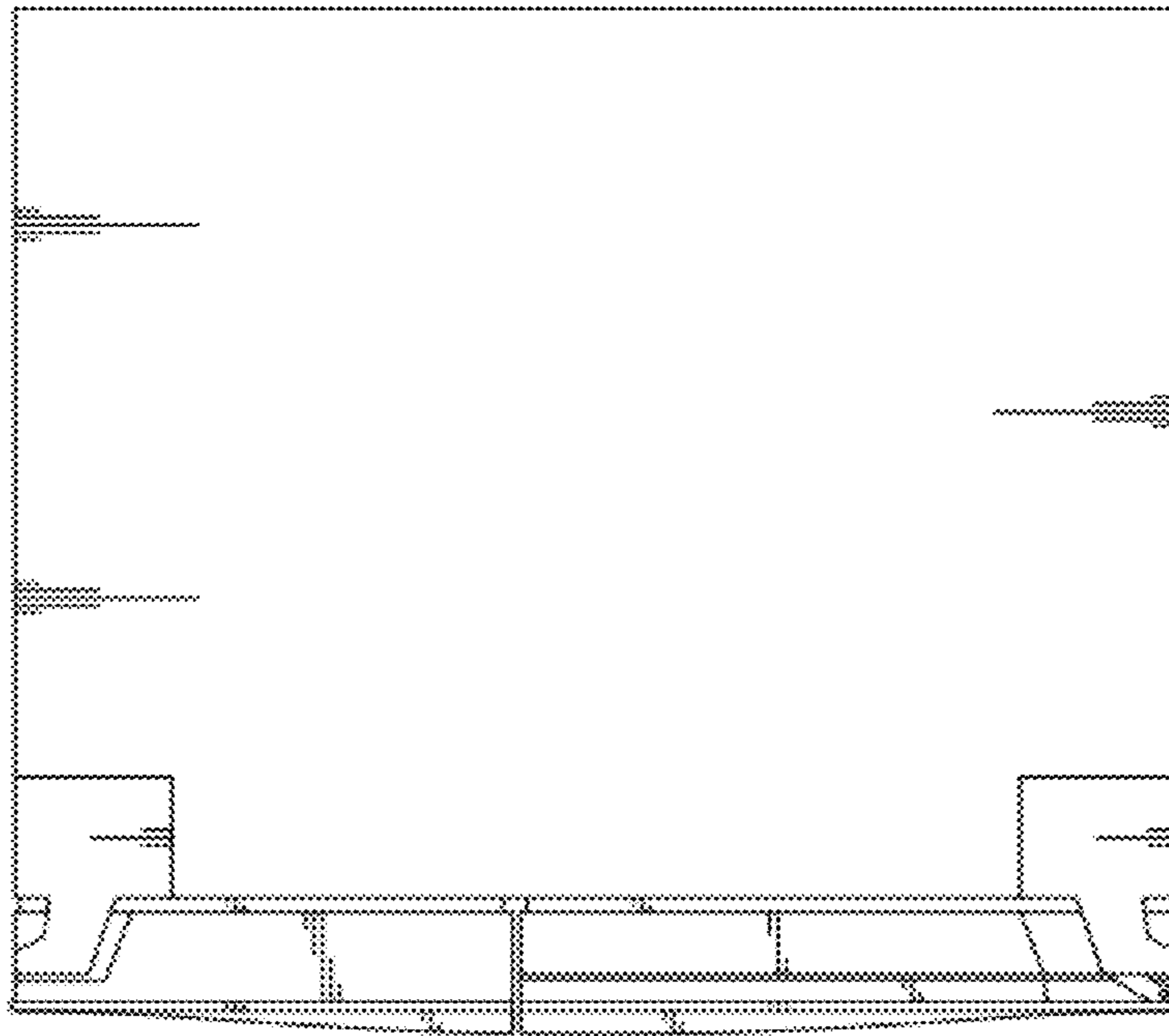

FIG. 7

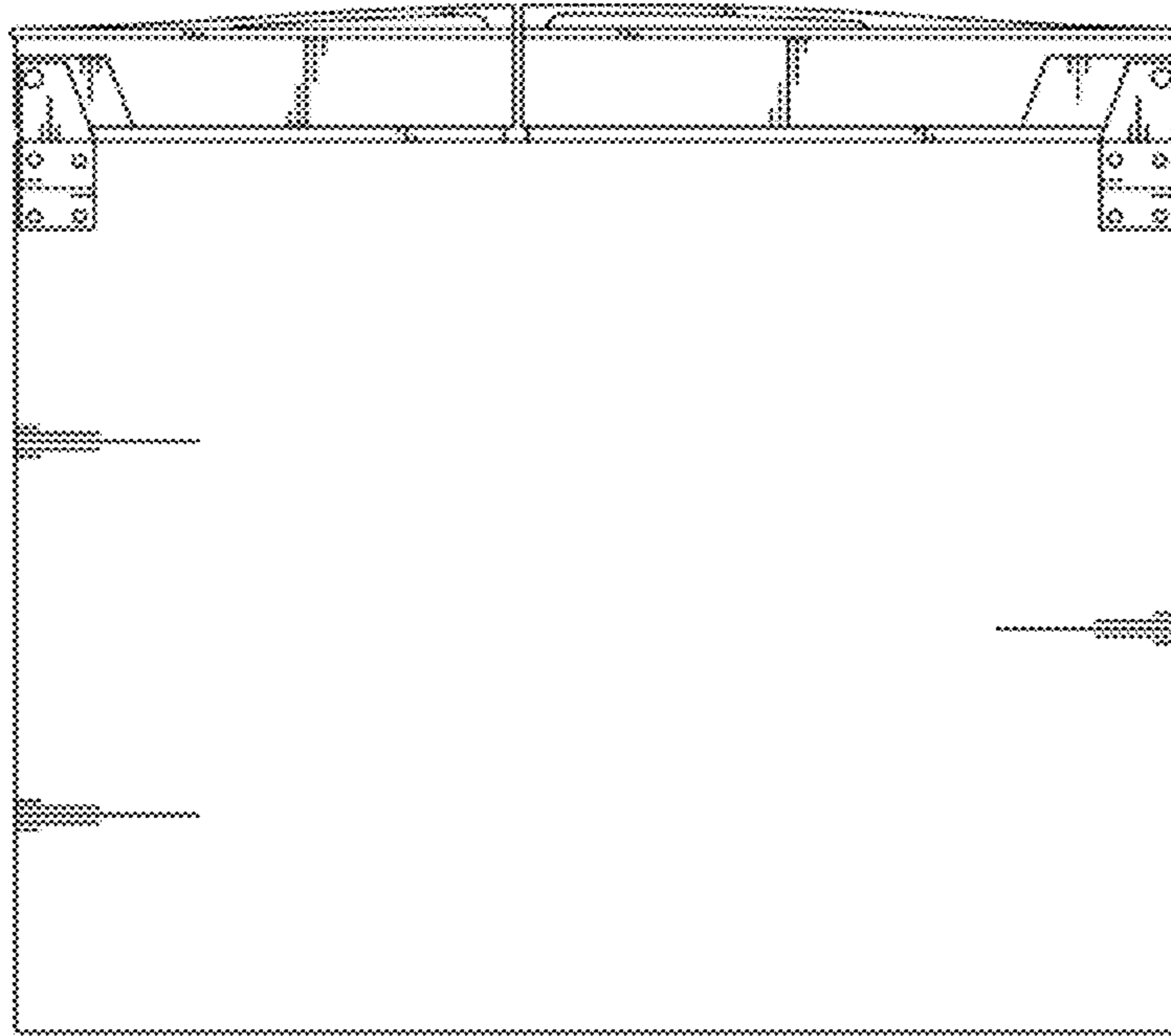

FIG. 8

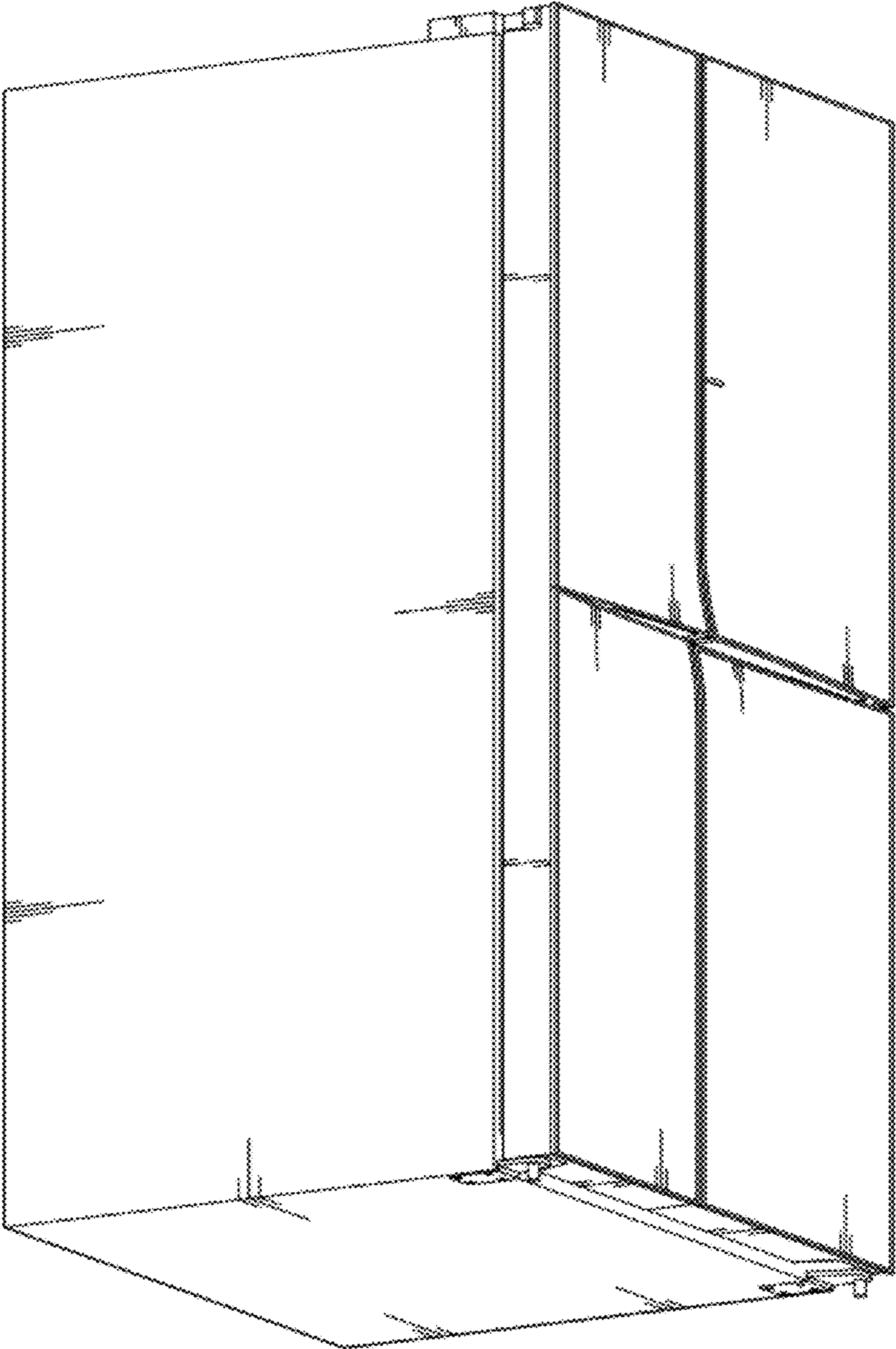

FIG. 9

