



US00D672279S

(12) **United States Design Patent**
Kalbach

(10) **Patent No.:** **US D672,279 S**
(45) **Date of Patent:** **** Dec. 11, 2012**

(54) **LEASH DEVICE HOLDER**

(75) Inventor: **Edward Van Lee Kalbach**, Nibley, UT (US)

(73) Assignee: **EK Ekcessories, Inc.**, Logan, UT (US)

(**) Term: **14 Years**

(21) Appl. No.: **29/416,036**

(22) Filed: **Mar. 16, 2012**

(51) **LOC (9) Cl.** **02-07**

(52) **U.S. Cl.** **D11/201**

(58) **Field of Classification Search** D11/1-2,
D11/200-201, 206-210, 214-218; 24/163 R,
24/169-171, 173, 177-179, 191, 194-195,
24/197, 200, 614-616, 625, 198
See application file for complete search history.

(56) **References Cited**

U.S. PATENT DOCUMENTS

452,830	A	5/1891	Bowie et al.	
652,891	A	7/1900	Cochran	
D49,184	S *	6/1916	Helm	D3/215
1,270,207	A	6/1918	Preston	
1,509,781	A	9/1924	Roth	
1,803,214	A *	4/1931	Siegel	24/698.3
1,819,738	A	8/1931	Daniel	
2,481,946	A	9/1949	Pendleton	
2,539,922	A	1/1951	Nyberg	
2,572,889	A	10/1951	Strykower	
2,660,092	A	11/1953	Bloom	

(Continued)

OTHER PUBLICATIONS

“J.A.M. Plastics, Inc. Catalog” Oct. 1, 1996, Anaheim California.

(Continued)

Primary Examiner — Ralf Seifert

(74) *Attorney, Agent, or Firm* — TraskBritt, P.C.

(57) **CLAIM**

The ornamental design for a leash device holder, as shown and described.

DESCRIPTION

FIG. 1 is a perspective view of a leash device holder showing my new design;

FIG. 2 is a rear view of the leash device holder shown in FIG. 1;

FIG. 3 is a front view of the leash device holder shown in FIG. 1;

FIG. 4 is a first side view of the leash device holder shown in FIG. 1;

FIG. 5 is a second side view of the leash device holder shown in FIG. 1;

FIG. 6 is a perspective view of a second embodiment of a leash device holder showing my new design;

FIG. 7 is a rear view of the leash device holder shown in FIG. 6;

FIG. 8 is a front view of the leash device holder shown in FIG. 6;

FIG. 9 is a first side view of the leash device holder shown in FIG. 6;

FIG. 10 is a second side view of the leash device holder shown in FIG. 6;

FIG. 11 is a perspective view of a third embodiment of a leash device holder showing my new design;

FIG. 12 is an exploded perspective view of the leash device holder shown in FIG. 11;

FIG. 13 is a rear view of the leash device holder shown in FIG. 11;

FIG. 14 is a front view of the leash device holder shown in FIG. 11;

FIG. 15 is a first side view of the leash device holder shown in FIG. 11; and,

FIG. 16 is a second side view of the leash device holder shown in FIG. 11.

1 Claim, 10 Drawing Sheets

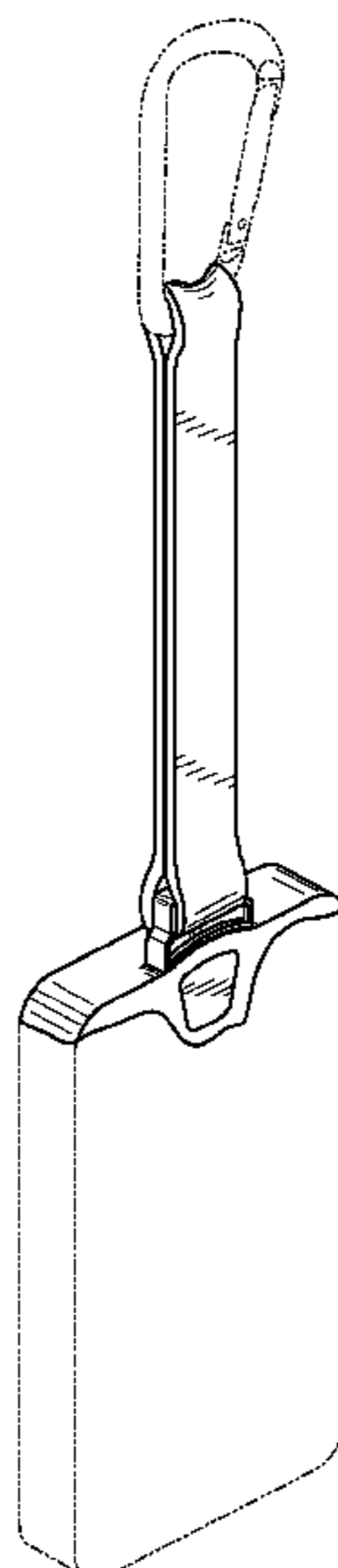

U.S. PATENT DOCUMENTS

2,704,961 A 3/1955 Weil
 2,775,804 A 1/1957 Ayoub
 2,783,926 A 3/1957 Wise
 2,947,456 A 8/1960 Seron
 3,397,026 A 8/1968 Spina
 3,450,467 A 6/1969 Phillips
 D216,075 S 11/1969 D'Elia et al.
 D222,150 S 10/1971 McCarty
 3,874,776 A 4/1975 Seron
 3,879,804 A 4/1975 Lawrence
 D237,845 S 12/1975 Saji
 3,927,808 A 12/1975 Steen
 D245,728 S 9/1977 Rials
 4,133,604 A 1/1979 Fuller
 4,156,574 A 5/1979 Boden
 4,171,555 A 10/1979 Bakker et al.
 D265,638 S 8/1982 Barr
 D273,440 S 4/1984 Fulwiler
 D278,369 S 4/1985 Pringle et al.
 4,541,696 A 9/1985 Wnger et al.
 D285,865 S 9/1986 Gamble
 4,657,364 A 4/1987 Murrell
 D290,964 S 7/1987 Kalbach
 D291,894 S 9/1987 Weisenfeld et al.
 4,696,556 A 9/1987 Perry, III
 D292,543 S 11/1987 Smith
 D292,750 S 11/1987 Smith
 D293,043 S * 12/1987 Zamboni D2/624
 D309,619 S 7/1990 Kalbach
 D310,305 S 9/1990 Scognamillo et al.
 D310,448 S 9/1990 Scognamillo et al.
 4,976,531 A 12/1990 Kahaney
 4,978,210 A 12/1990 Lundbeck
 5,002,381 A 3/1991 Murrell
 5,015,085 A 5/1991 May
 5,027,477 A 7/1991 Seron
 D320,367 S 10/1991 Kalbach
 5,092,668 A 3/1992 Welch et al.
 D328,186 S 7/1992 Hanke
 D328,908 S 8/1992 Kalbach
 5,151,778 A 9/1992 Conley
 5,157,425 A 10/1992 Liu
 5,215,237 A 6/1993 Wu
 5,369,452 A 11/1994 Williams
 D354,759 S 1/1995 Wolff
 D354,760 S 1/1995 Wolff
 5,414,903 A 5/1995 Porteous
 D366,007 S 1/1996 Colpo
 D371,154 S 6/1996 Kalbach
 5,575,042 A 11/1996 Kalbach
 5,582,337 A 12/1996 McPherson et al.
 D377,562 S 1/1997 Wolfram
 D382,503 S 8/1997 Kalbach
 5,654,787 A 8/1997 Barison
 D383,993 S 9/1997 Kalbach
 D385,415 S 10/1997 Turbide
 D386,310 S 11/1997 Smith
 D386,610 S 11/1997 Wright
 D392,583 S 3/1998 Hoffman
 D393,183 S * 4/1998 Kurtzman D7/633
 5,842,256 A 12/1998 Anscher
 5,860,191 A 1/1999 Sieger
 D416,038 S 11/1999 Kalbach
 6,000,795 A 12/1999 Van Rysselberghe
 D418,774 S 1/2000 Kalbach
 D423,783 S 5/2000 Steurer
 6,092,897 A 7/2000 Smerdon, Jr.
 D432,401 S 10/2000 Kalbach

6,182,334 B1 2/2001 Davancens
 D446,109 S 8/2001 Kalbach
 D462,513 S 9/2002 Holzhaus et al.
 D462,523 S 9/2002 Kalbach
 D467,416 S 12/2002 Kalbach
 D472,798 S 4/2003 Kalbach
 D477,709 S 7/2003 Natividad
 D485,209 S * 1/2004 Tracy et al. D11/216
 D486,511 S 2/2004 Kalbach
 D487,015 S 2/2004 Kalbach
 6,709,100 B2 3/2004 Kalbach
 6,711,785 B1 3/2004 Hicks et al.
 6,752,305 B2 6/2004 Shattuck
 D507,110 S 7/2005 Hicks et al.
 D520,241 S 5/2006 Hicks et al.
 7,056,028 B2 6/2006 Hosoda et al.
 D532,201 S 11/2006 Esch
 D536,173 S 2/2007 Hicks et al.
 D536,364 S 2/2007 Kalbach
 D539,697 S 4/2007 Mackay
 D541,190 S 4/2007 Plzak
 D541,523 S 5/2007 Zoullas et
 D544,400 S 6/2007 Yoshiguchi
 D557,008 S 12/2007 Stiller
 D567,704 S 4/2008 Martin
 D601,916 S 10/2009 Moss
 D619,495 S 7/2010 Herman
 D621,606 S 8/2010 Marquardt
 D628,797 S 12/2010 Kalbach
 D628,798 S 12/2010 Kalbach
 D629,331 S 12/2010 Kalbach
 D634,232 S 3/2011 Kelly et al.
 D637,478 S 5/2011 Kalbach
 D638,330 S 5/2011 Fahrendorff et al.
 D639,642 S 6/2011 Kalbach
 D644,139 S 8/2011 Kalbach
 2004/0001179 A1 1/2004 Kalbach

OTHER PUBLICATIONS

“Shockers Eyewear Retainers & Sports Accessories Catalog,” 1989-1999, Newberg, Oregon.
 “Shockers Eyewear Retainers & Sports Accessories Catalog,” 1997, Portland, Oregon.
 “SnugZ USA Catalog” Jan. 1, 1997.
 “SnugZ USA Catalog” Jan. 1, 2000.
 CIPI—Products—Neckwear & Wristwear—Lanyards, 1997.
 CIPI—Products—Neckwear & Wristwear—Lanyards, Feb. 13, 1998, Website.
 CIPI Product Line website visited Dec. 27, 2001.
 CWA Lanyards, p. 1, Website, at least as early as Feb. 1999.
 EK Ekcessories Catalog@ ASI Promotion Products, Jan. 1999.
 EK Ekcessories Catalog@ Aug. 1997.
 EK Ekcessories Catalog@ Jan. 1998.
 EK Ekcessories Pamphlet@ Industrial and Security, at least as early as Mar. 2002.
 EK Ekcessories, Inc. Product Catalog@ Aug. 1993, pp. 16 and 17.
 EK Ekcessories, Inc. Product Catalog@ Aug. 1994, pp. 8 and 9.
 EK Keycessories Catalog@ at least as early as Mar. 2002.
 IRIS Catalog, Lanyards, at least as early as Feb. 1999.
 Neon Lanyards . . . Braided nylon lanyards with . . . , 1995-98, Website.
 Shockers, 1997, Dealer Price List.
 The Logo Shop Catalog, Logo Watch Co., p. 2, 1997, Logan Utah.
 XTROS USA@ products flyer. , at least as early as Mar. 2002.

* cited by examiner

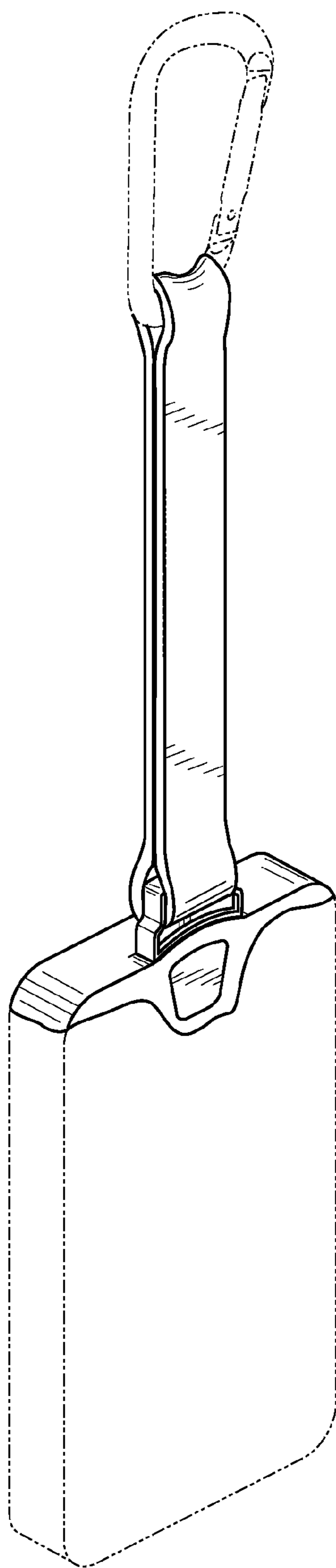

FIG. 1

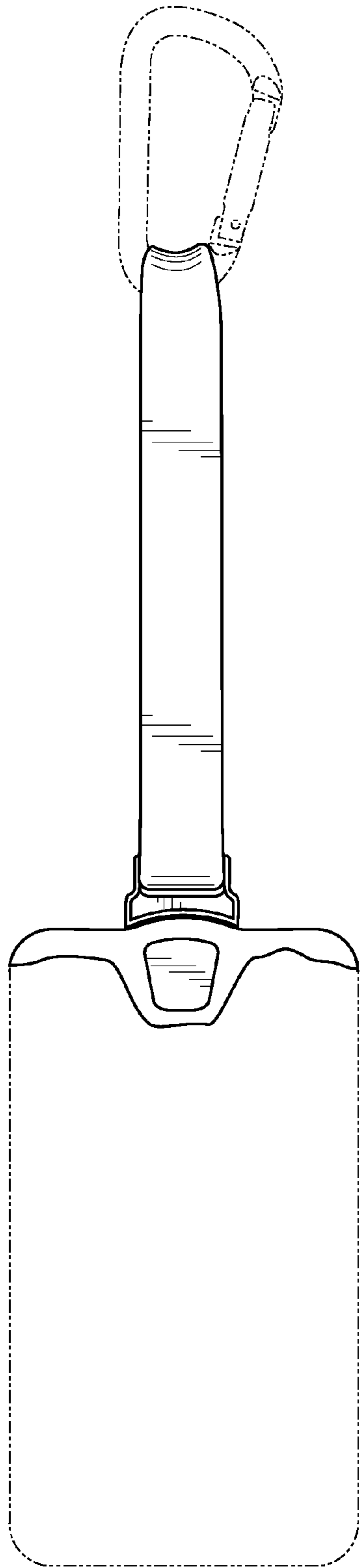

FIG. 2

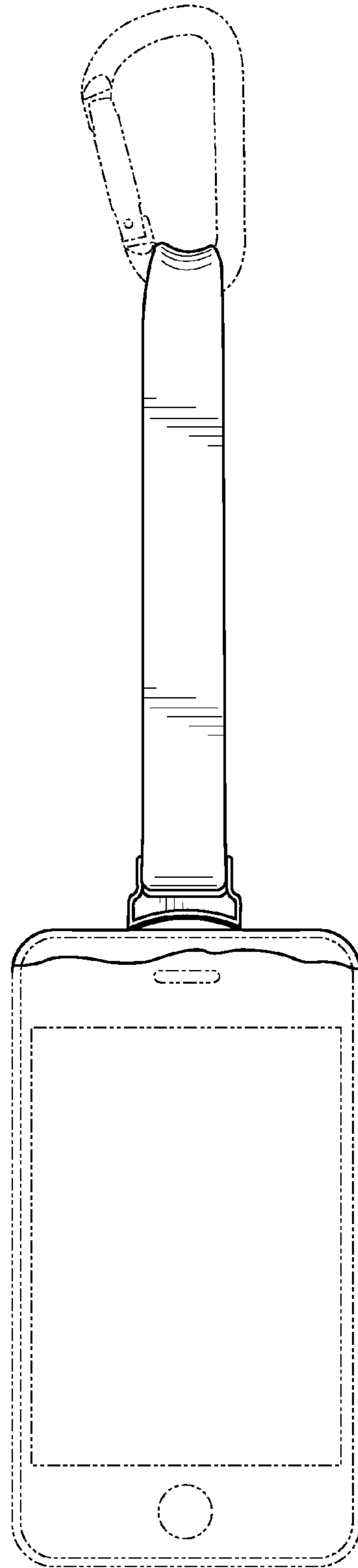

FIG. 3

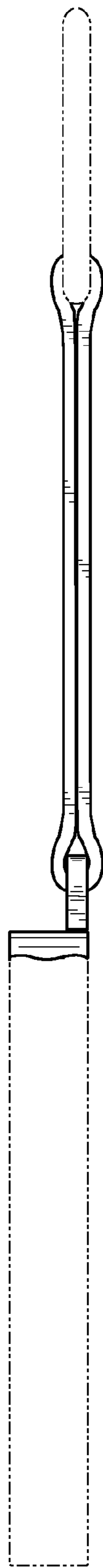

FIG. 4

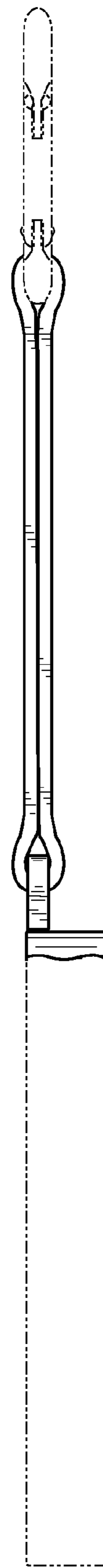

FIG. 5

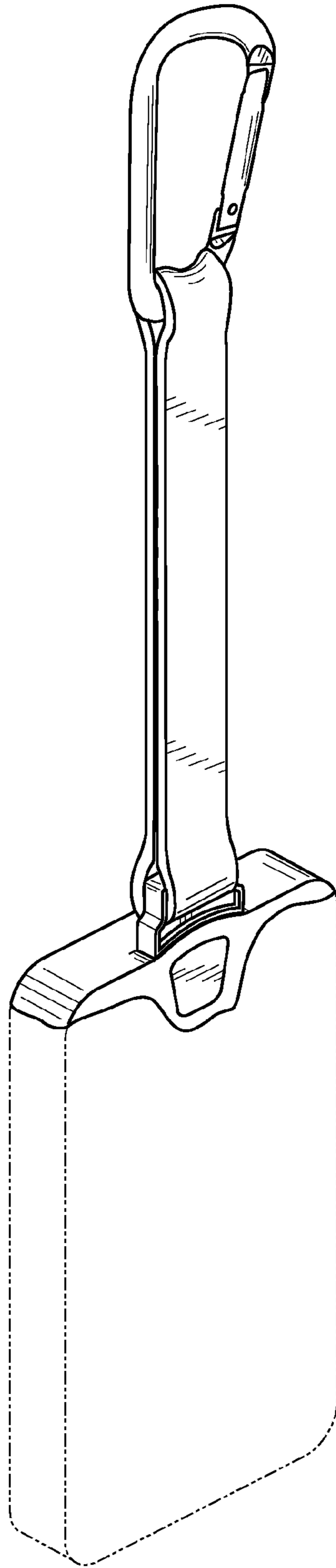

FIG. 6

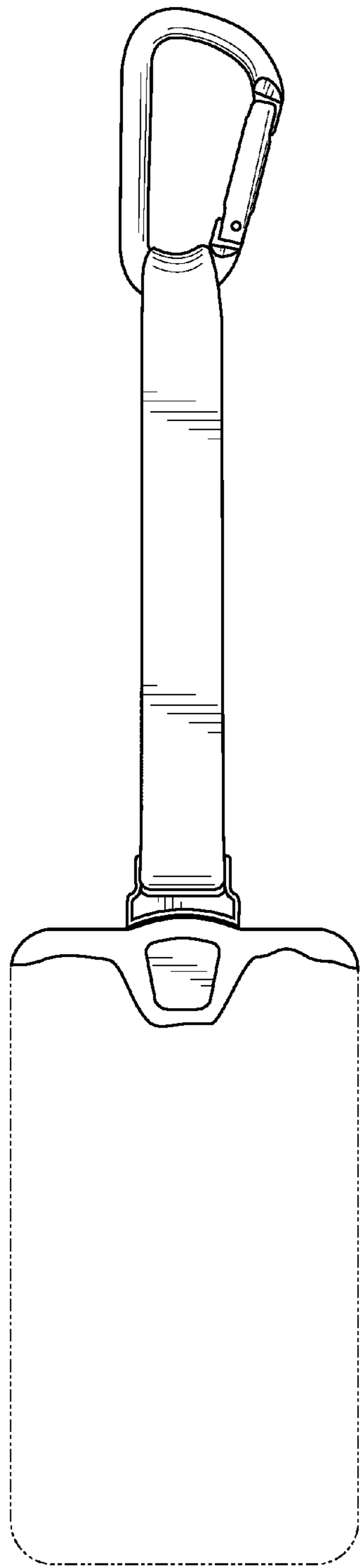

FIG. 7

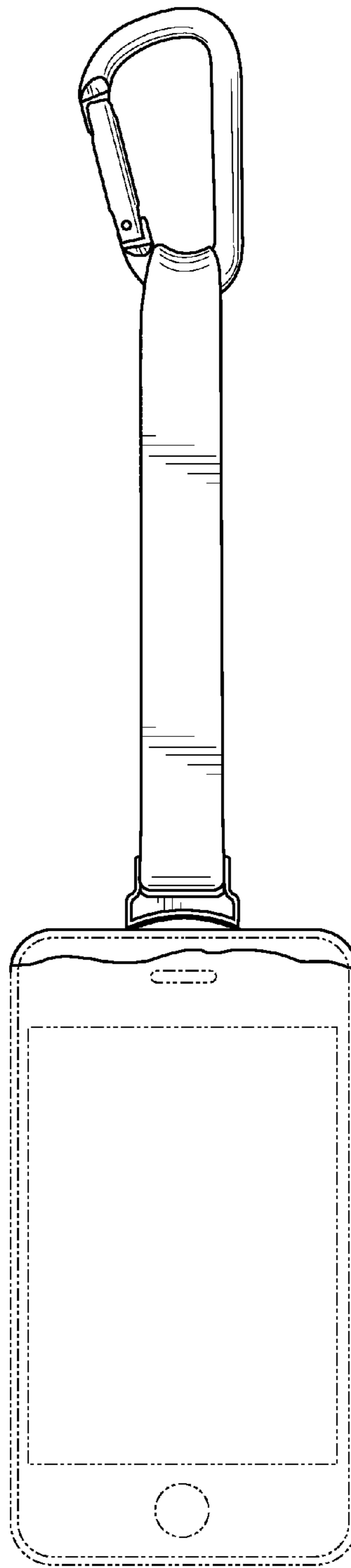

FIG. 8

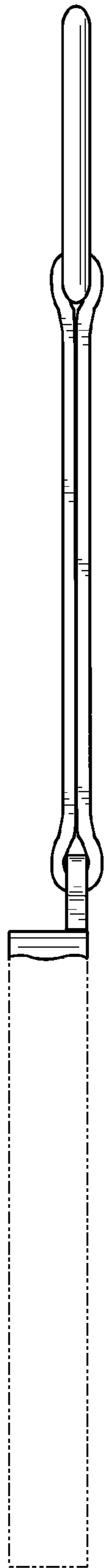

FIG. 9

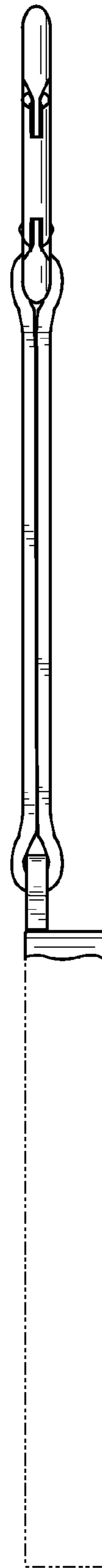

FIG. 10

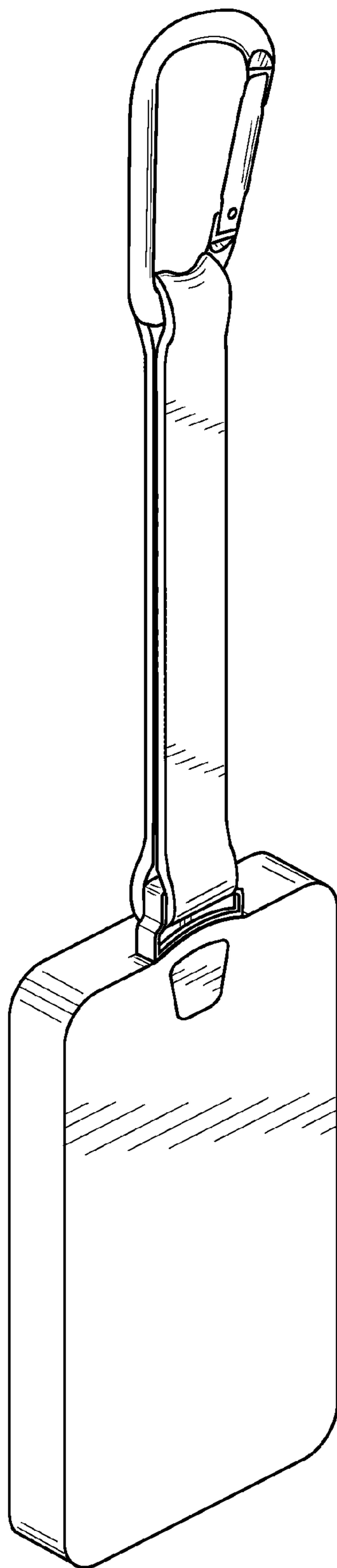

FIG. 11

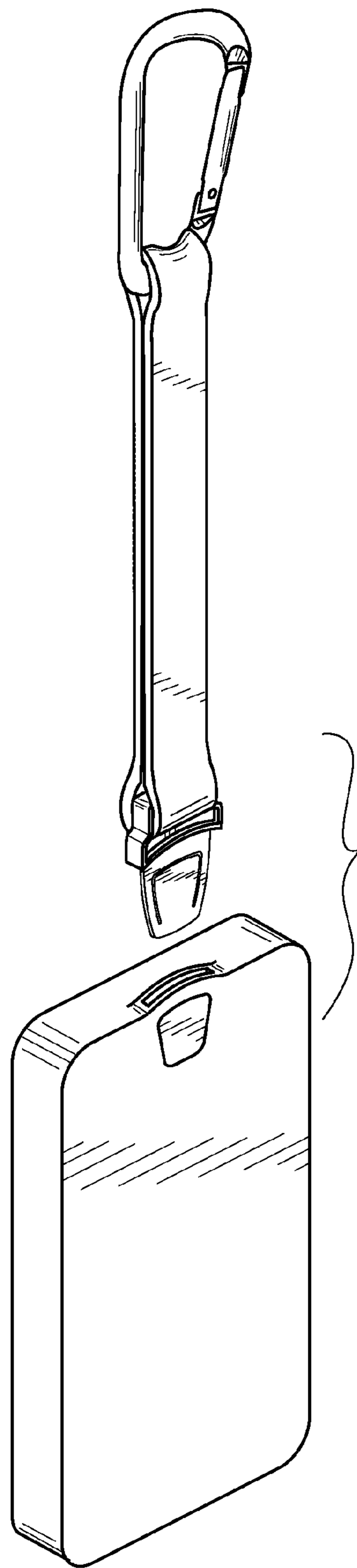

FIG. 12

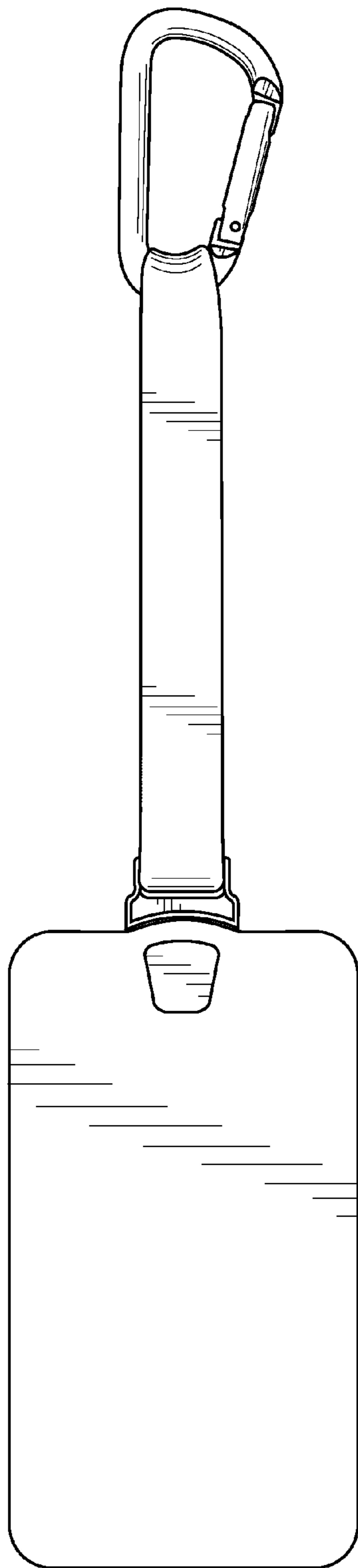

FIG. 13

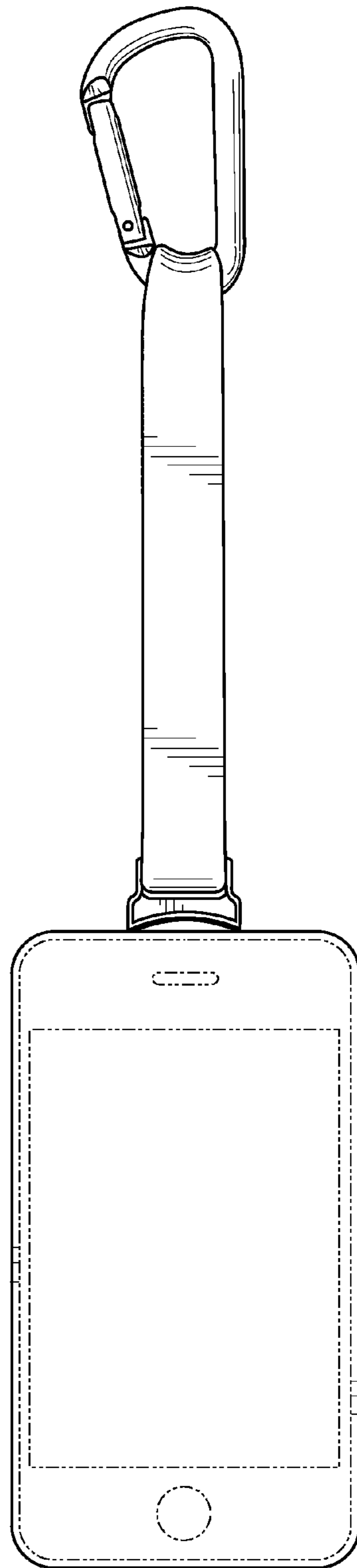

FIG. 14

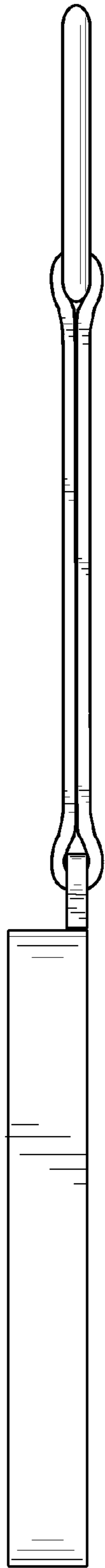

FIG. 15

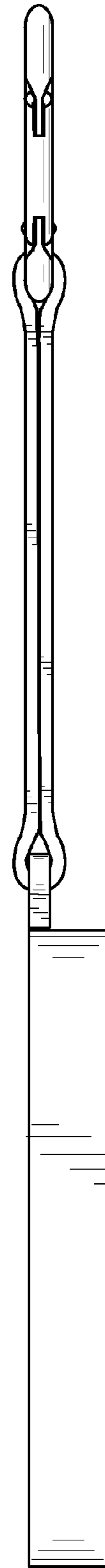

FIG. 16