



US00D672091S

(12) **United States Design Patent**
Dyson et al.

(10) **Patent No.:** **US D672,091 S**
(45) **Date of Patent:** **** Dec. 4, 2012**

(54) **HAND DRYER**

(75) Inventors: **James Dyson**, Malmesbury (GB); **Peter David Gammack**, Malmesbury (GB); **Leigh Michael Ryan**, Malmesbury (GB)

(73) Assignee: **Dyson Limited**, Malmesbury (GB)

(**) Term: **14 Years**

(21) Appl. No.: **29/412,985**

(22) Filed: **Feb. 9, 2012**

(30) **Foreign Application Priority Data**

Aug. 17, 2011 (EM) 001905449-0002

(51) **LOC (9) Cl.** **28-03**

(52) **U.S. Cl.** **D28/54.1**

(58) **Field of Classification Search** D28/12,
D28/54.1, 58; 34/266, 201, 202; 392/381,
392/380; D23/357, 361, 385

See application file for complete search history.

(56) **References Cited**

U.S. PATENT DOCUMENTS

D220,180 S * 3/1971 Griffin D28/54.1

D334,998 S * 4/1993 Warner et al. D28/58
D428,204 S * 7/2000 Elliott D28/54.1
D483,152 S * 12/2003 Martinuzzo et al. D28/54.1
D533,305 S * 12/2006 Takahashi et al. D28/54.1
D622,908 S * 8/2010 Sau Clerch D28/54.1

* cited by examiner

Primary Examiner — Zenia Bennett

(74) *Attorney, Agent, or Firm* — Morrison & Foerster LLP

(57) **CLAIM**

We claim the ornamental design for a hand dryer, as shown and described.

DESCRIPTION

FIG. 1 is a perspective view of a hand dryer showing our new design;

FIG. 2 is a front view thereof;

FIG. 3 is a side view thereof;

FIG. 4 is a side view of the opposite side of FIG. 3;

FIG. 5 is a back view thereof;

FIG. 6 is a top view thereof; and,

FIG. 7 is a bottom view thereof.

The broken lines in the drawing are for illustrative purposes only and form no part of the claimed design.

1 Claim, 7 Drawing Sheets

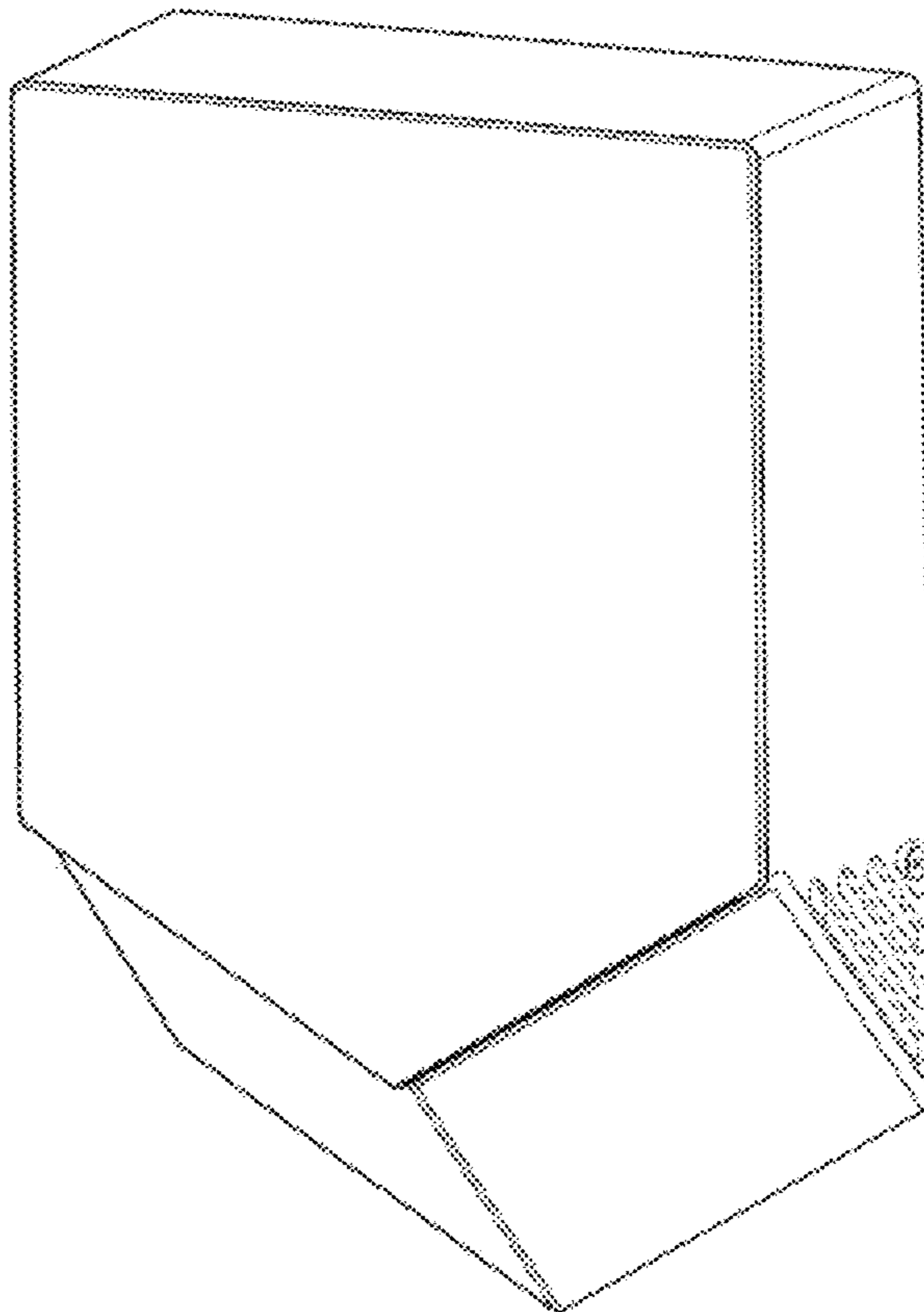

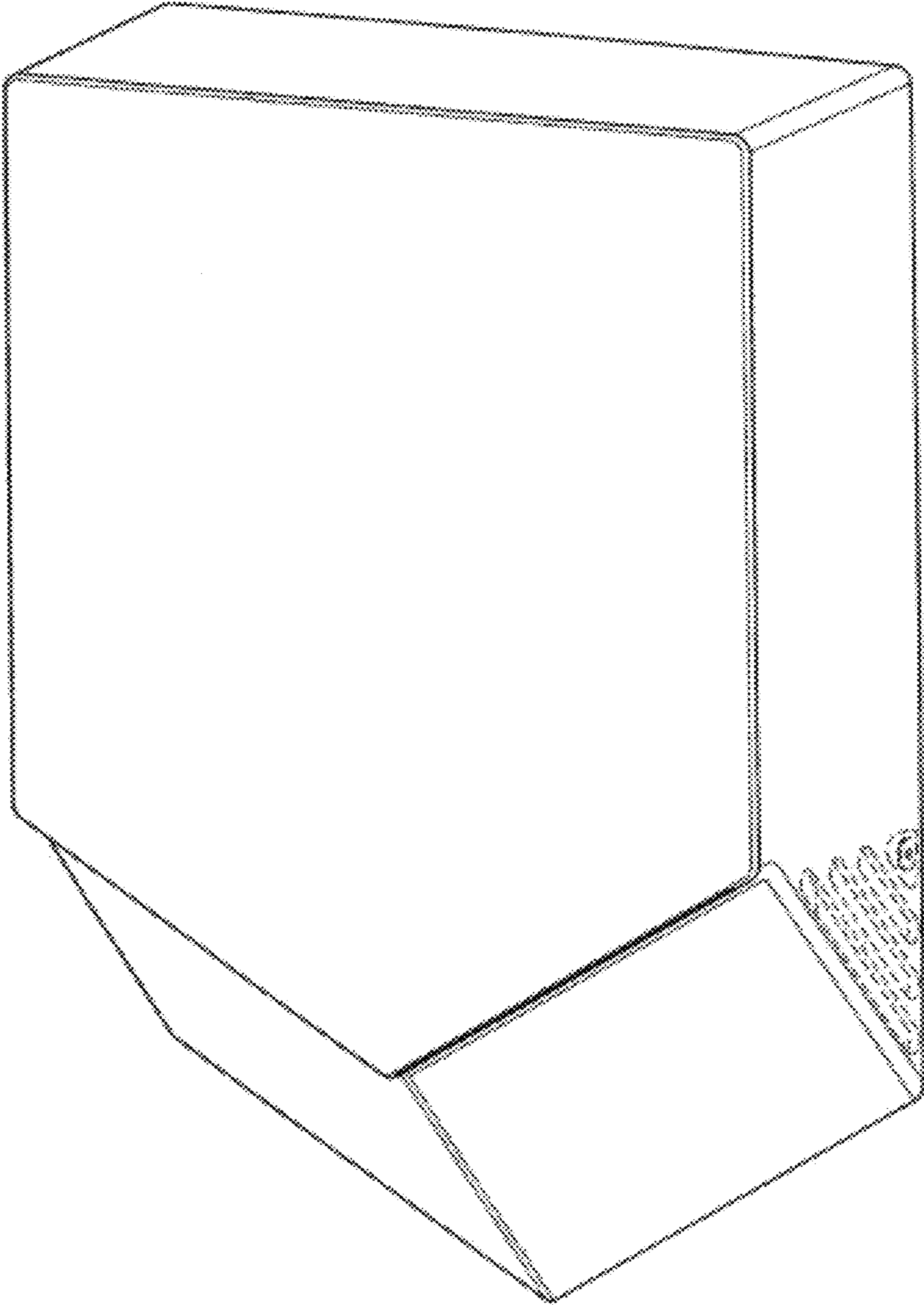

FIG. 1

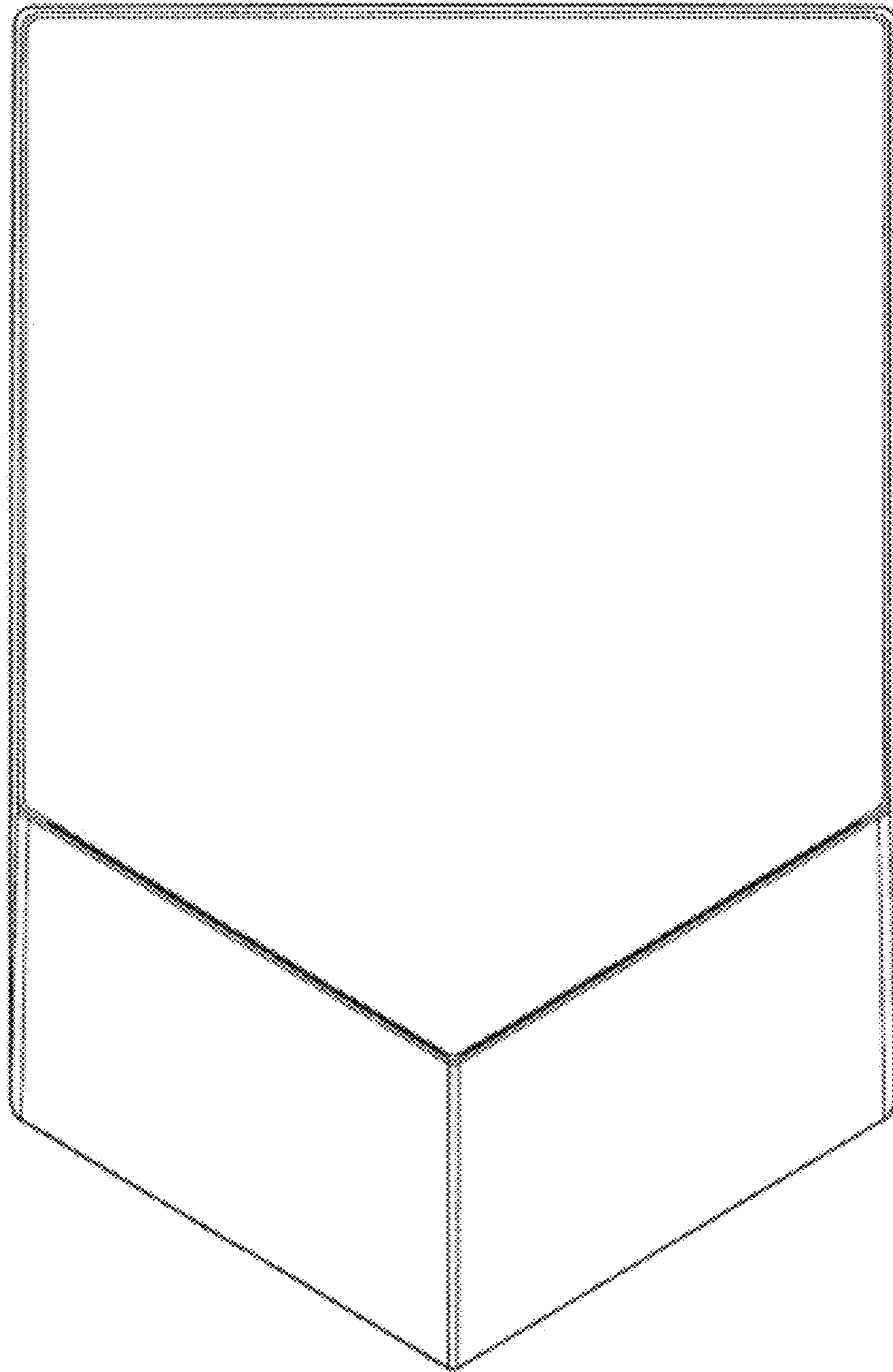

FIG. 2

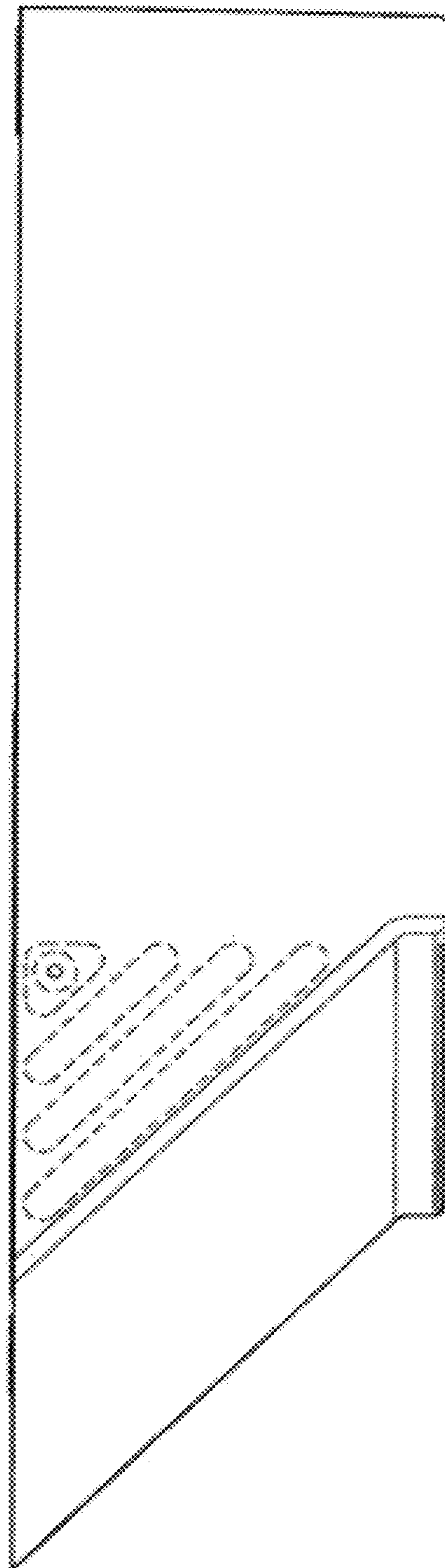

FIG. 3

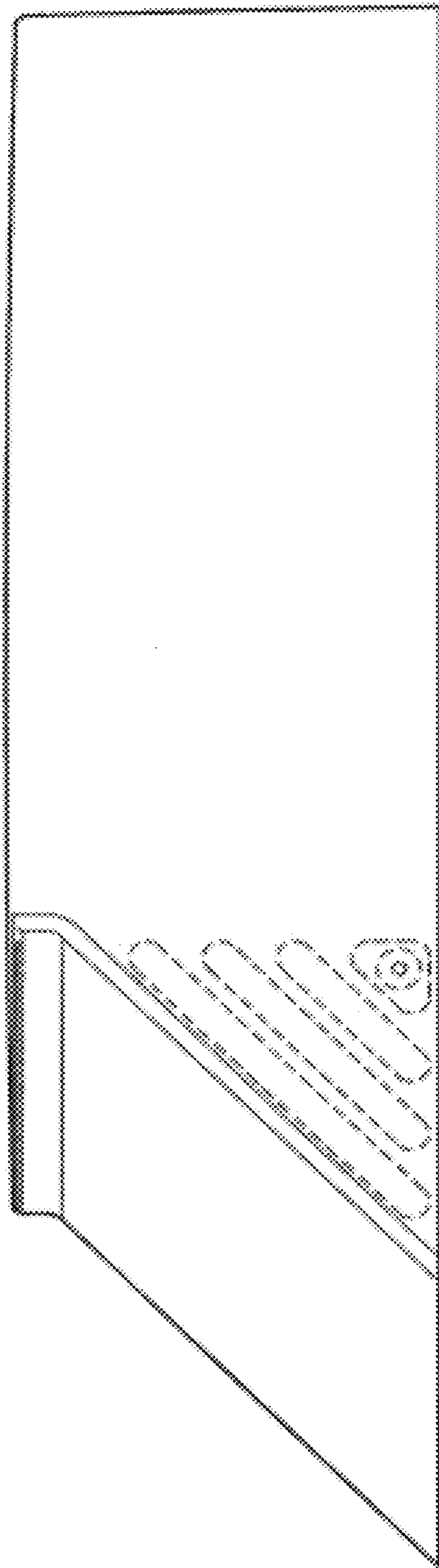

FIG. 4

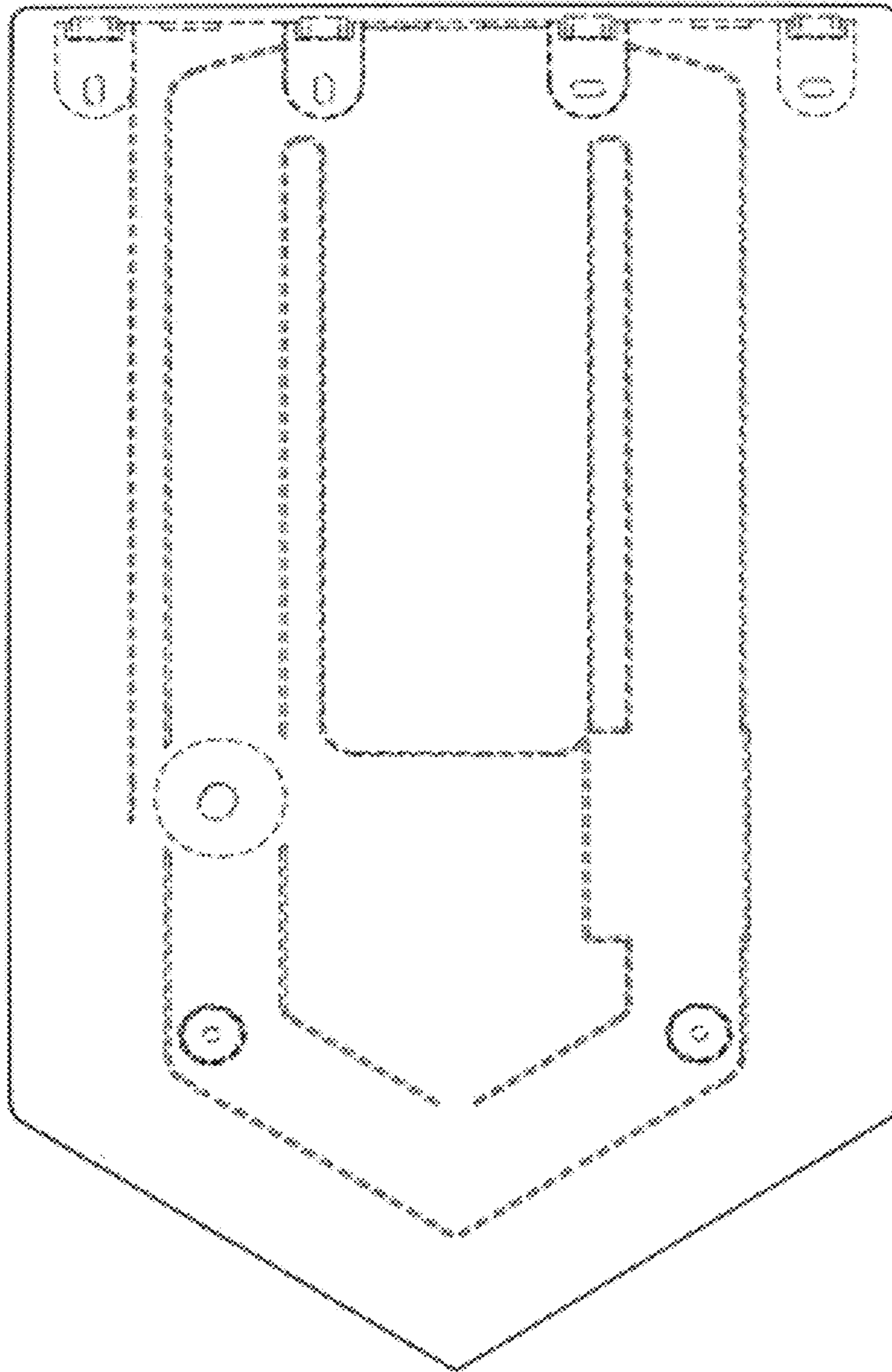

FIG. 5

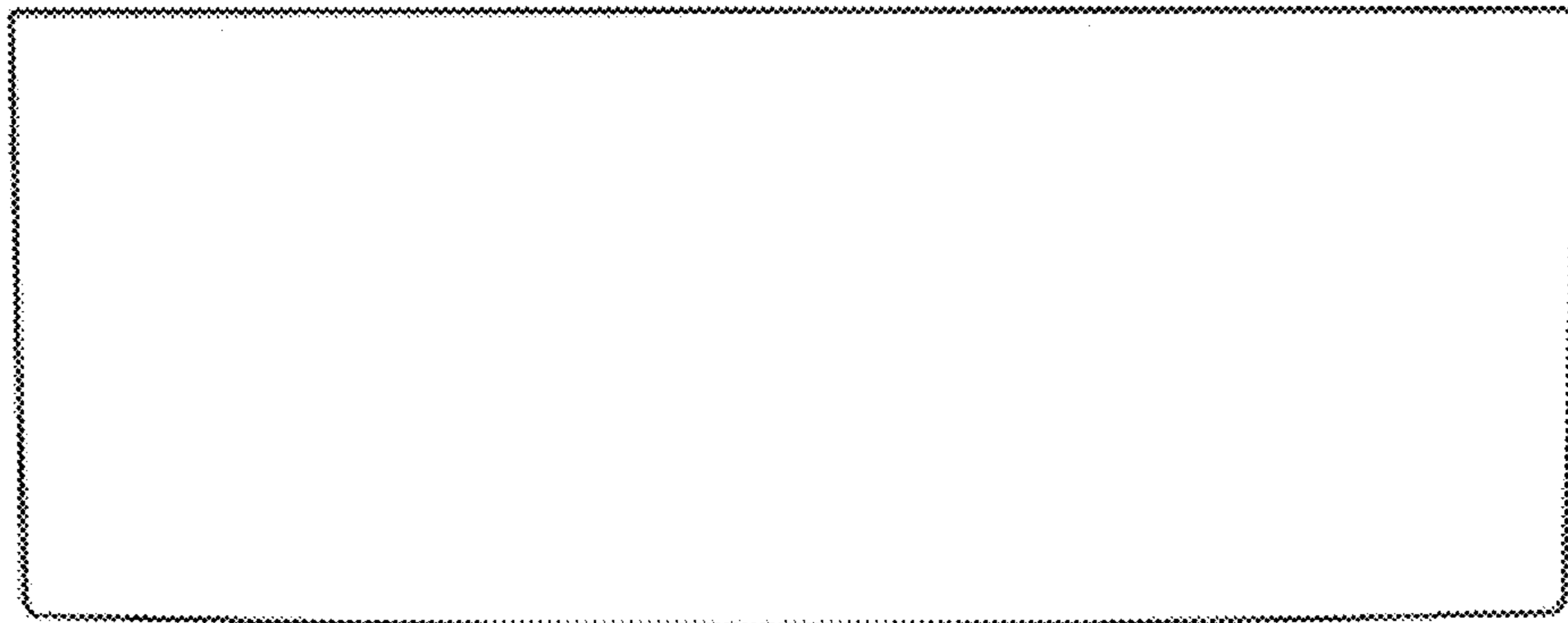

FIG. 6

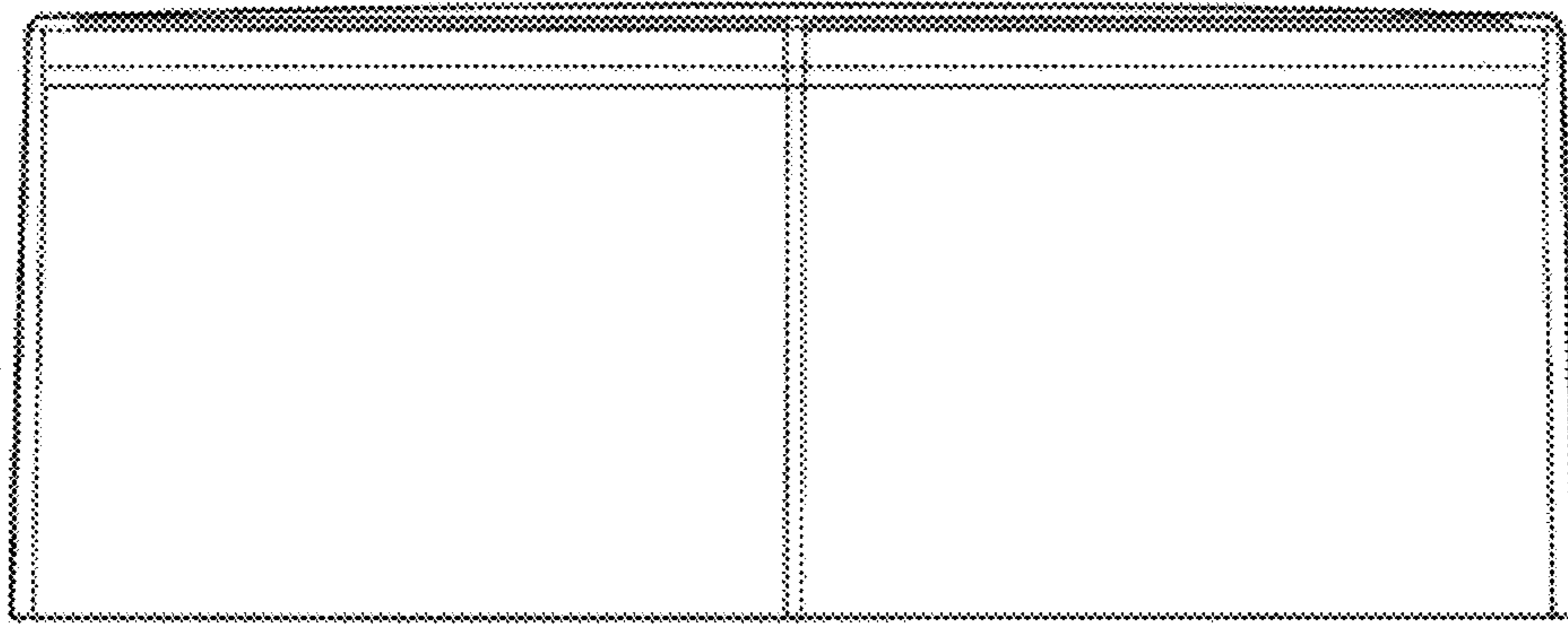

FIG. 7