



US00D671994S

(12) **United States Design Patent**  
**Wojtkiewicz**

(10) **Patent No.:** **US D671,994 S**  
(45) **Date of Patent:** **\*\* Dec. 4, 2012**

- (54) **CHILDREN’S PLAY TABLE**
- (75) Inventor: **Mark A. Wojtkiewicz**, Lancaster, NY (US)
- (73) Assignee: **Mattel, Inc.**, El Segundo, CA (US)
- (\*\*) Term: **14 Years**
- (21) Appl. No.: **29/397,001**
- (22) Filed: **Jul. 11, 2011**
- (51) **LOC (9) Cl.** ..... **21-01**
- (52) **U.S. Cl.** ..... **D21/522; D6/485**
- (58) **Field of Classification Search** ..... D21/484, D21/485, 493, 494, 519, 522; D6/349, 397, D6/422, 436, 451, 480, 484, 485, 490; 446/71, 446/73, 75, 77, 85, 91, 102–128; 108/11, 108/12, 13, 14, 25, 26  
See application file for complete search history.

D398,453 S *	9/1998	Stead	.....	D6/349
D406,964 S *	3/1999	Lewis	.....	D6/485
D463,166 S *	9/2002	Russell et al.	.....	D6/485
D508,803 S *	8/2005	Anderson	.....	D6/480
D549,492 S *	8/2007	Sheppard	.....	D6/485
D565,331 S *	4/2008	Miller	.....	D6/485
D567,536 S *	4/2008	Paterson	.....	D6/436
D611,734 S *	3/2010	Stukenberg et al.	.....	D6/484
D614,889 S *	5/2010	Van Duysen	.....	D6/484

\* cited by examiner

*Primary Examiner* — Cynthia M Chin

(74) *Attorney, Agent, or Firm* — Edell, Shapiro & Finnan, LLC

(57) **CLAIM**

The ornamental design for a children’s play table, as shown and described.

**DESCRIPTION**

FIG. 1 is a front perspective view of a children’s play table product according to the present invention;  
 FIG. 2 is front view of the children’s play table of FIG. 1;  
 FIG. 3 is a rear view of the children’s play table of FIG. 1;  
 FIG. 4 is a right side view of the children’s play table of FIG. 1;  
 FIG. 5 is a left side view of the children’s play table of FIG. 1;  
 FIG. 6 is a top view of the children’s play table of FIG. 1; and,  
 FIG. 7 is a bottom view of the children’s play table of FIG. 1.

**1 Claim, 4 Drawing Sheets**

(56) **References Cited**

**U.S. PATENT DOCUMENTS**

D139,325 S *	10/1944	Gass	.....	D6/349
D228,857 S *	10/1973	Allsop	.....	D6/480
D269,196 S *	5/1983	Appel et al.	.....	D21/522
4,886,326 A *	12/1989	Kuzyk	.....	D6/422
D330,475 S *	10/1992	Bennett	.....	D6/485
D371,701 S *	7/1996	Jolly	.....	D6/484

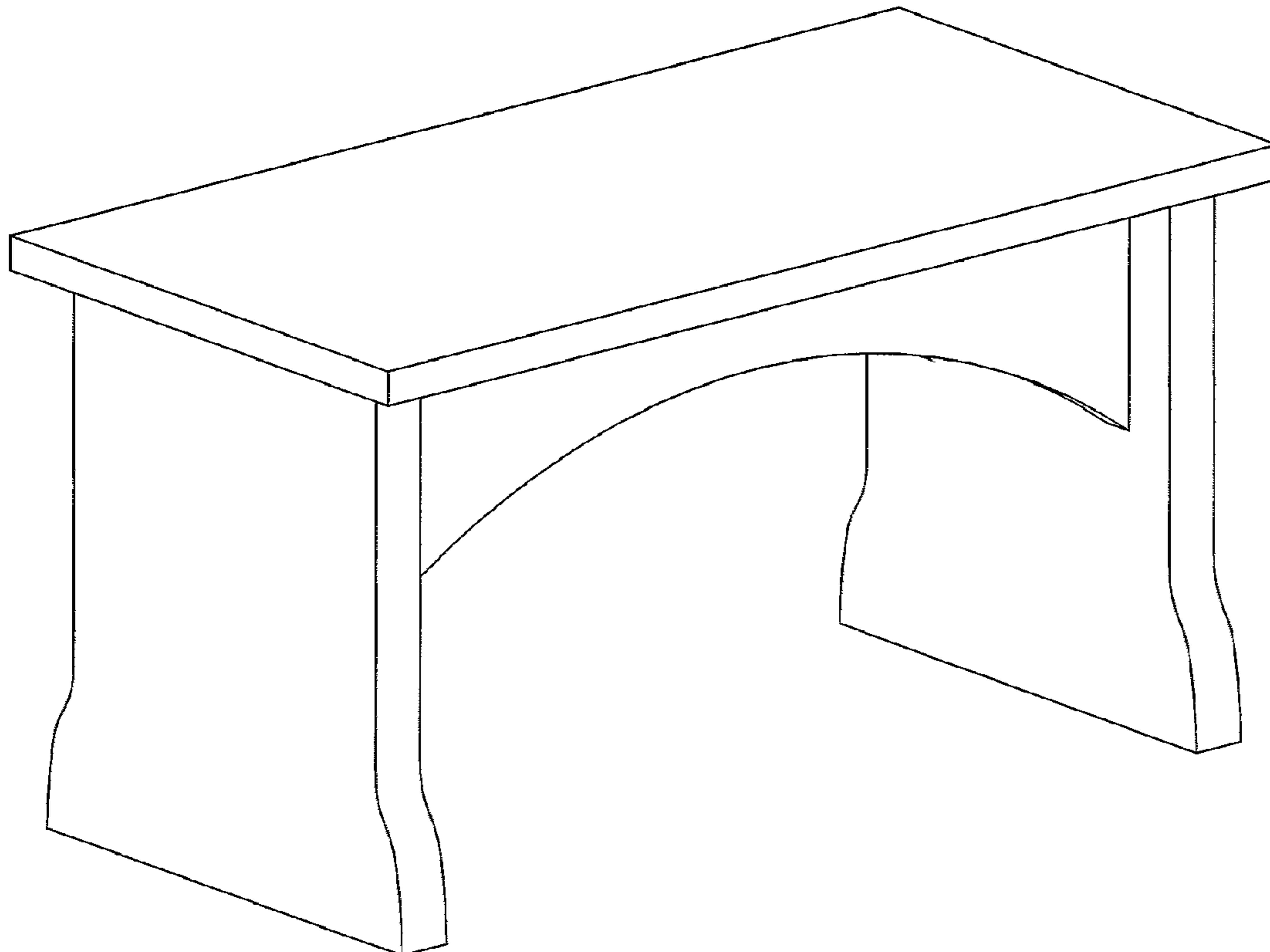

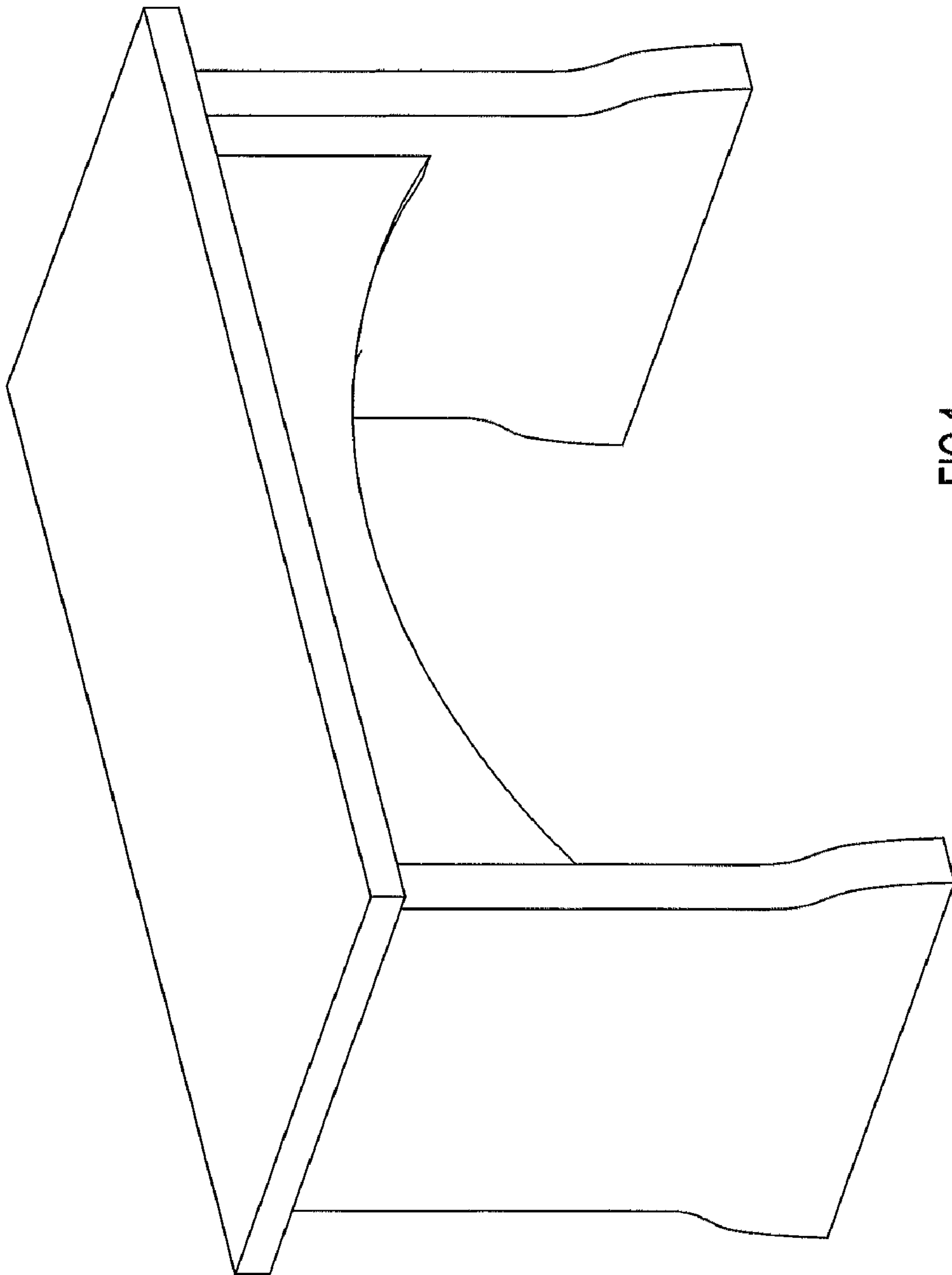

FIG. 1

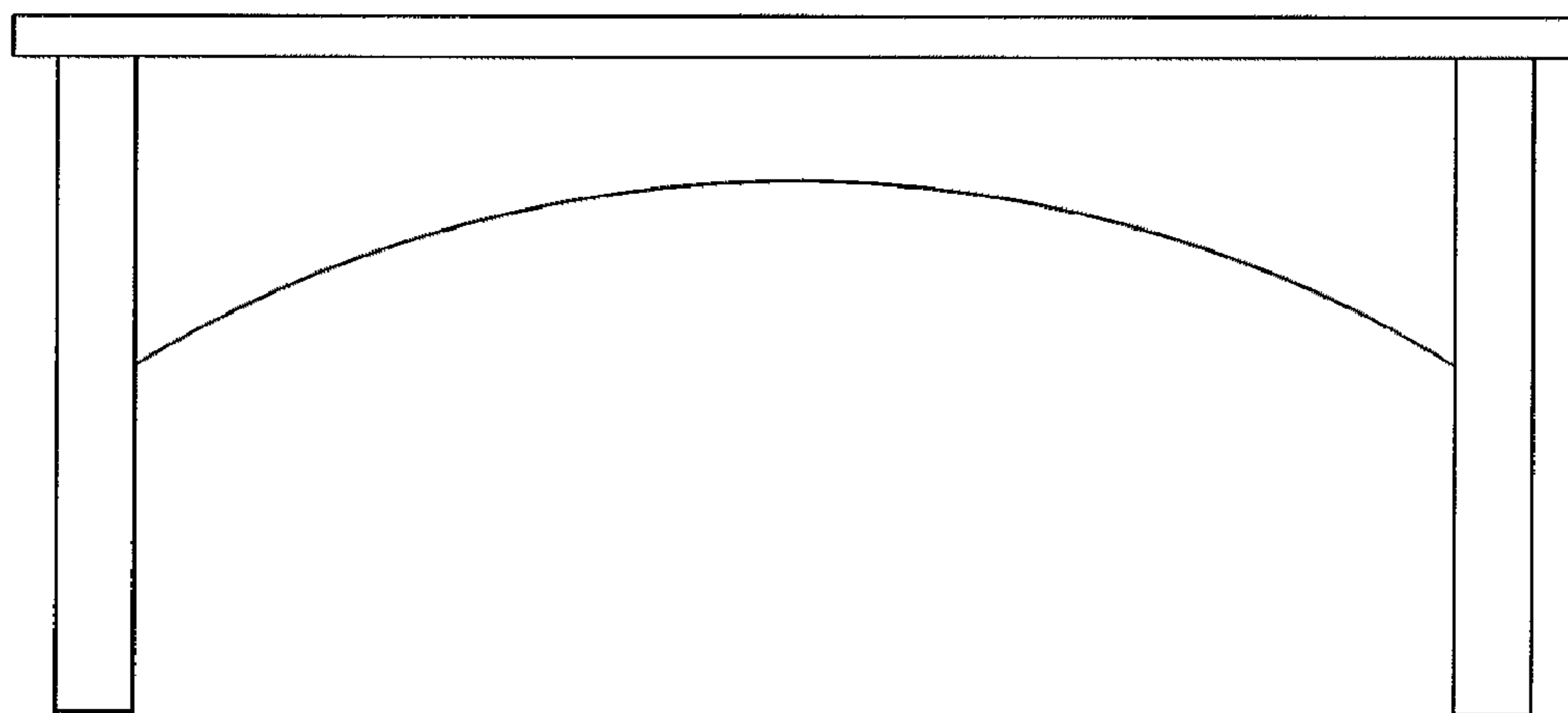

FIG.2

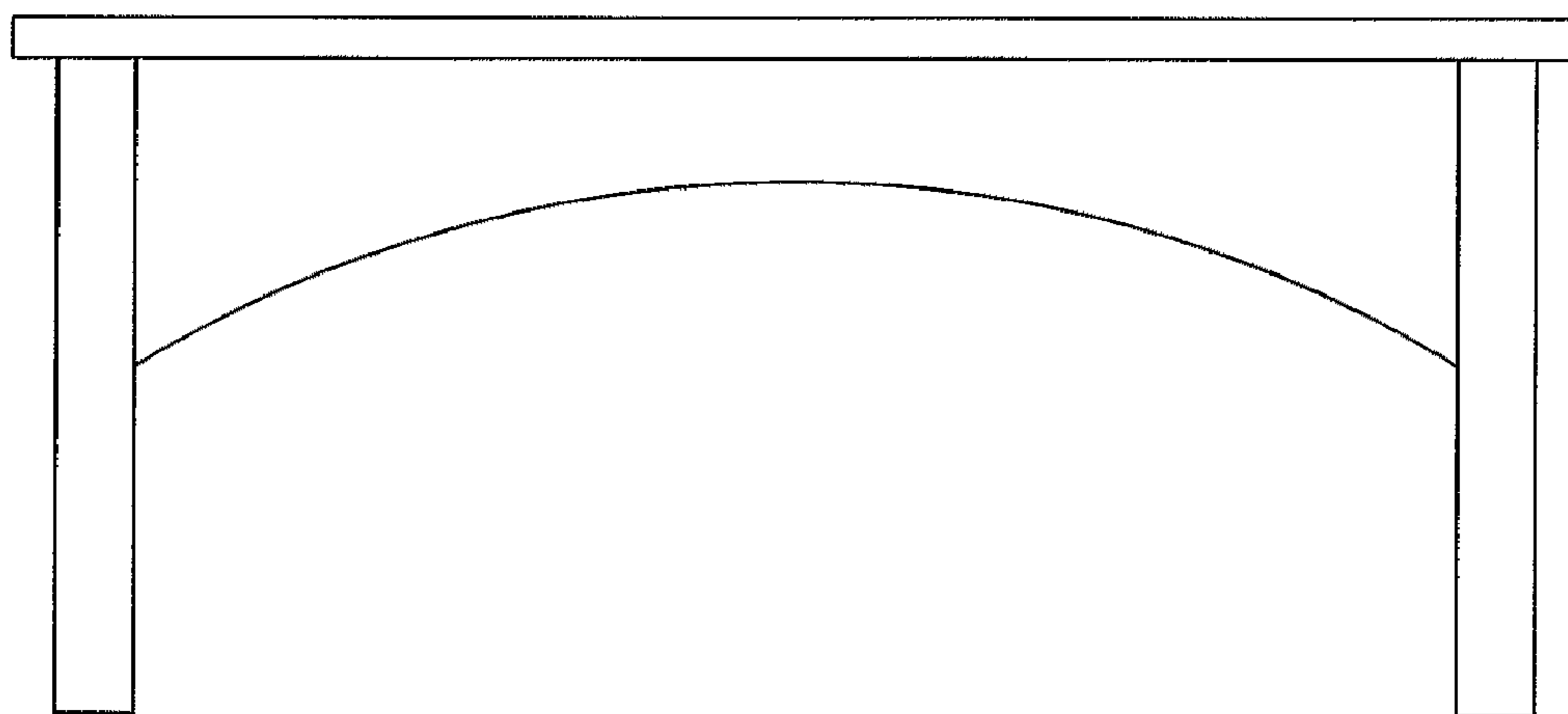

FIG.3

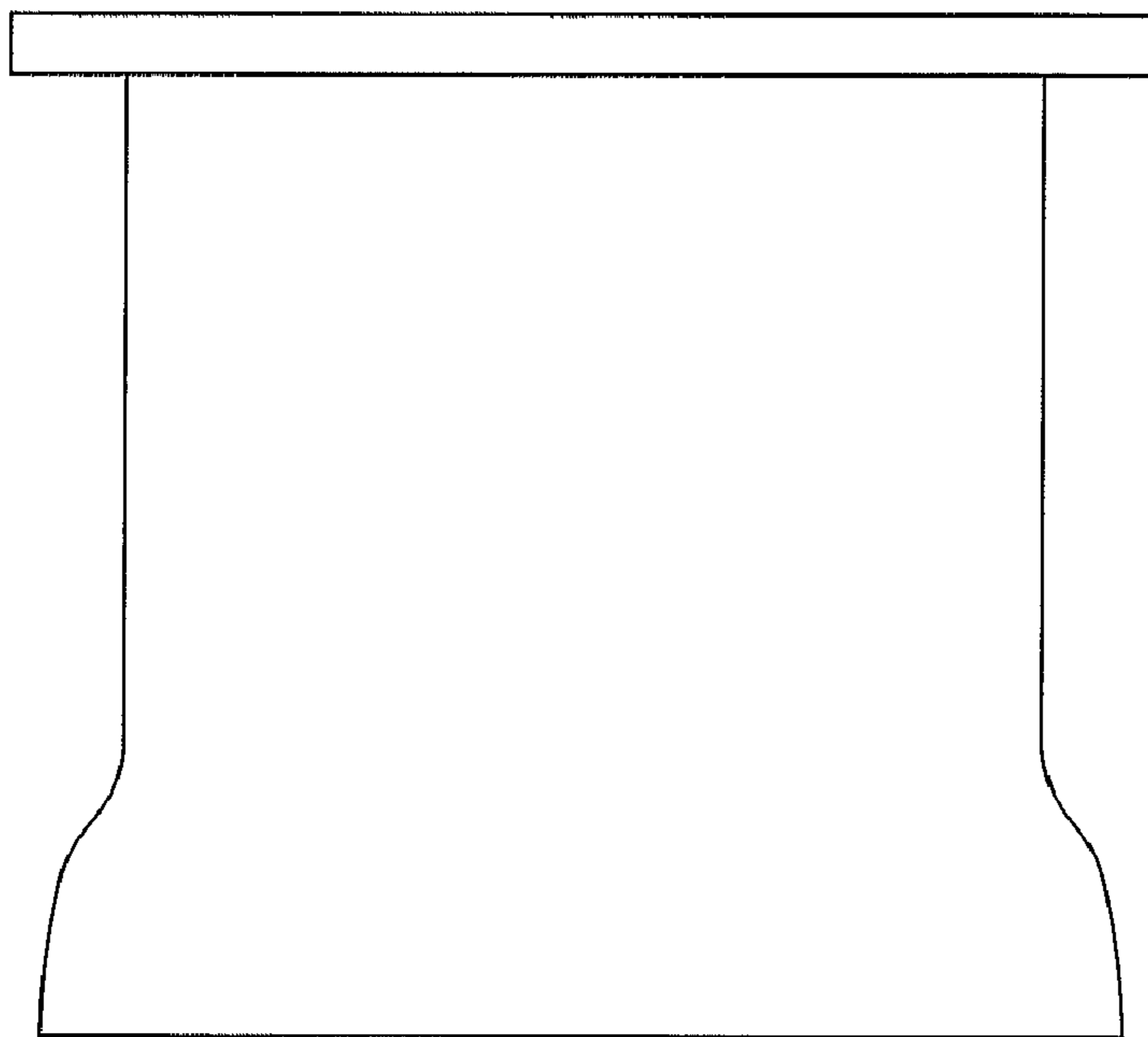

FIG.4

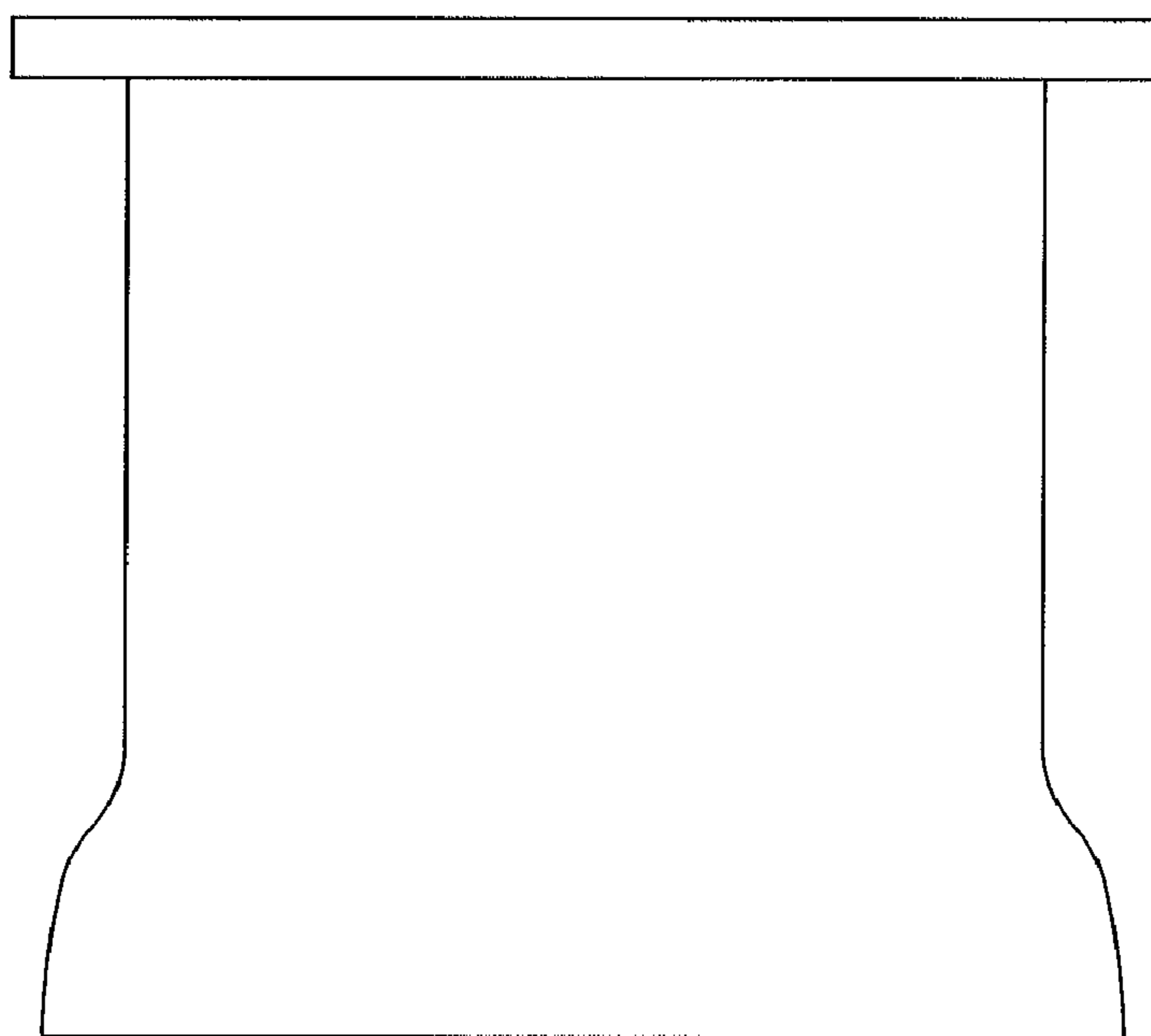

FIG.5

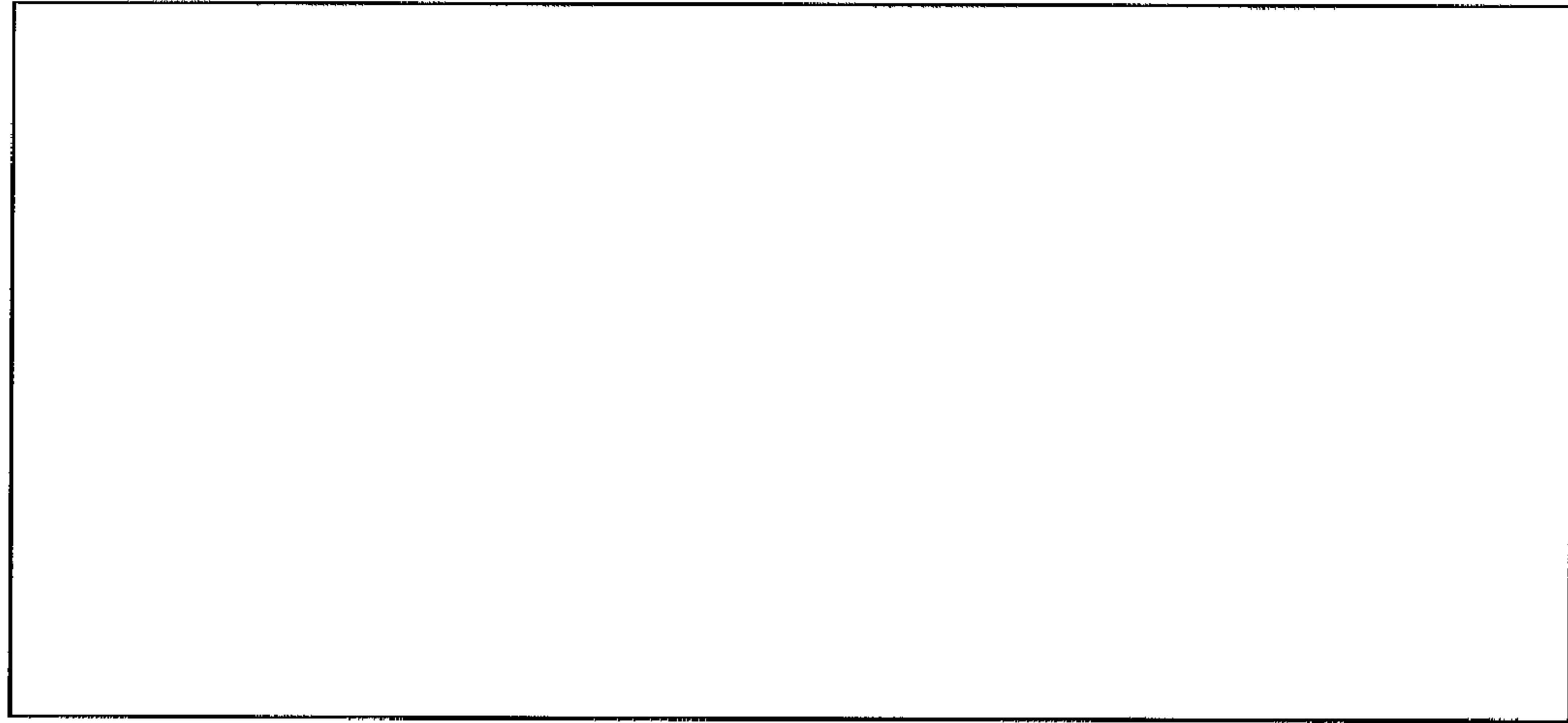

FIG.6

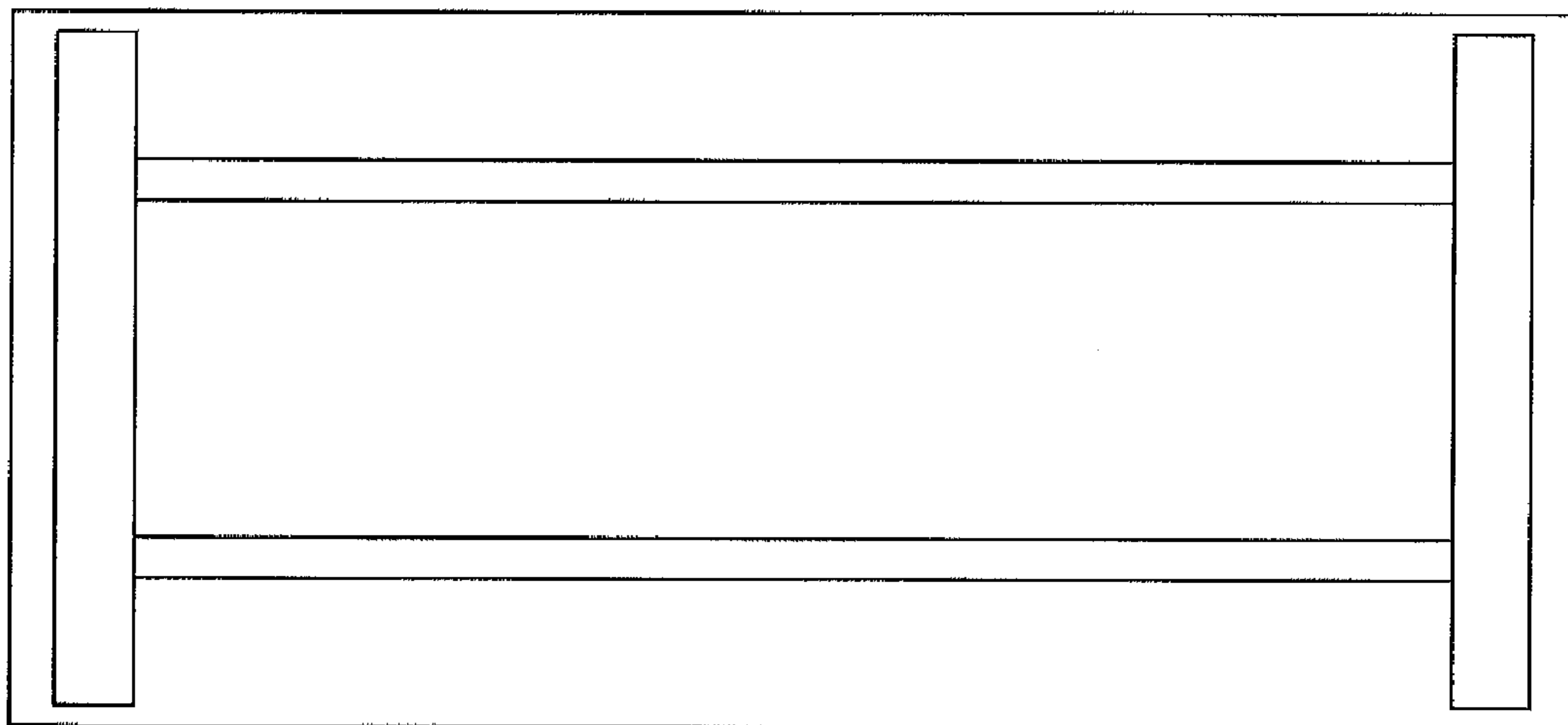

FIG.7