

US00D671940S

(12) **United States Design Patent**
Kim

(10) **Patent No.:** **US D671,940 S**
(45) **Date of Patent:** **** Dec. 4, 2012**

(54) **MOBILE PHONE MONITOR**

(75) Inventor: **Dong-Kyun Kim**, Seoul (KR)

(73) Assignee: **Samsung Electronics Co., Ltd.**,
Suwon-si (KR)

(**) Term: **14 Years**

(21) Appl. No.: **29/406,260**

(22) Filed: **Nov. 11, 2011**

(30) **Foreign Application Priority Data**

Jul. 29, 2011 (KR) 30-2011-0031692

(51) **LOC (9) Cl.** **14-02**

(52) **U.S. Cl.** **D14/374; D14/130**

(58) **Field of Classification Search** D14/371-376,
D14/125-130, 336, 337, 341, 217, 142, 239,
D14/240, 434, 238.1; D6/308, 311; 345/104,
345/156, 173, 174; 361/679.08, 679.23;
349/1, 2, 11, 58; 248/917-924, 371; 341/12
See application file for complete search history.

(56) **References Cited**

U.S. PATENT DOCUMENTS

D490,420 S * 5/2004 Solomon et al. D14/341
D504,889 S * 5/2005 Andre et al. D14/341
D617,793 S * 6/2010 Chiang et al. D14/341
D629,373 S * 12/2010 Kim et al. D14/126

D639,266 S * 6/2011 DeLorenzo et al. D14/142
D644,228 S * 8/2011 Corsini et al. D14/434
2003/0236102 A1* 12/2003 Kawai et al. 455/550.1

* cited by examiner

Primary Examiner — Freda S Nunn

(74) *Attorney, Agent, or Firm* — NSIP Law

(57) **CLAIM**

The ornamental design for a mobile phone monitor, as shown and described.

DESCRIPTION

FIG. 1 is a perspective view of a mobile phone monitor;
FIG. 2 is a front view of the mobile phone monitor of FIG. 1;
FIG. 3 is a rear view of the mobile phone monitor of FIG. 1;
FIG. 4 is a left-side view of the mobile phone monitor of FIG. 1;
FIG. 5 is a right-side view of the mobile phone monitor of FIG. 1;
FIG. 6 is a top plan view of the mobile phone monitor of FIG. 1;
FIG. 7 is a bottom plan view of the mobile phone monitor of FIG. 1; and,
FIG. 8 is a rear perspective view of the mobile phone monitor of FIG. 1, in which a mobile phone shown in broken lines for environmental purposes only and forms no part of the claimed design illustrates an example of how the mobile phone may be docketed in the mobile phone monitor of FIG. 1.

1 Claim, 6 Drawing Sheets

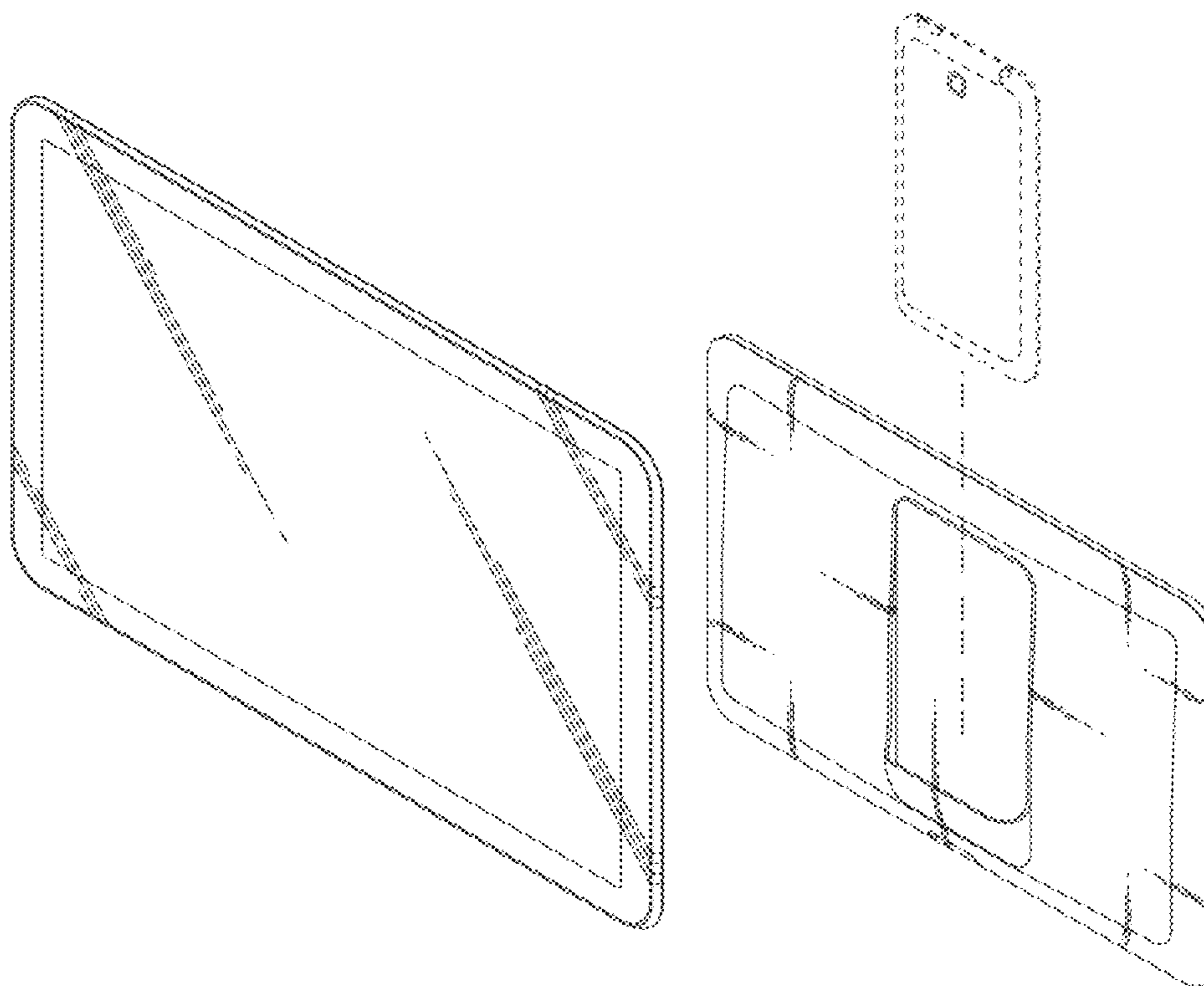

FIG. 1

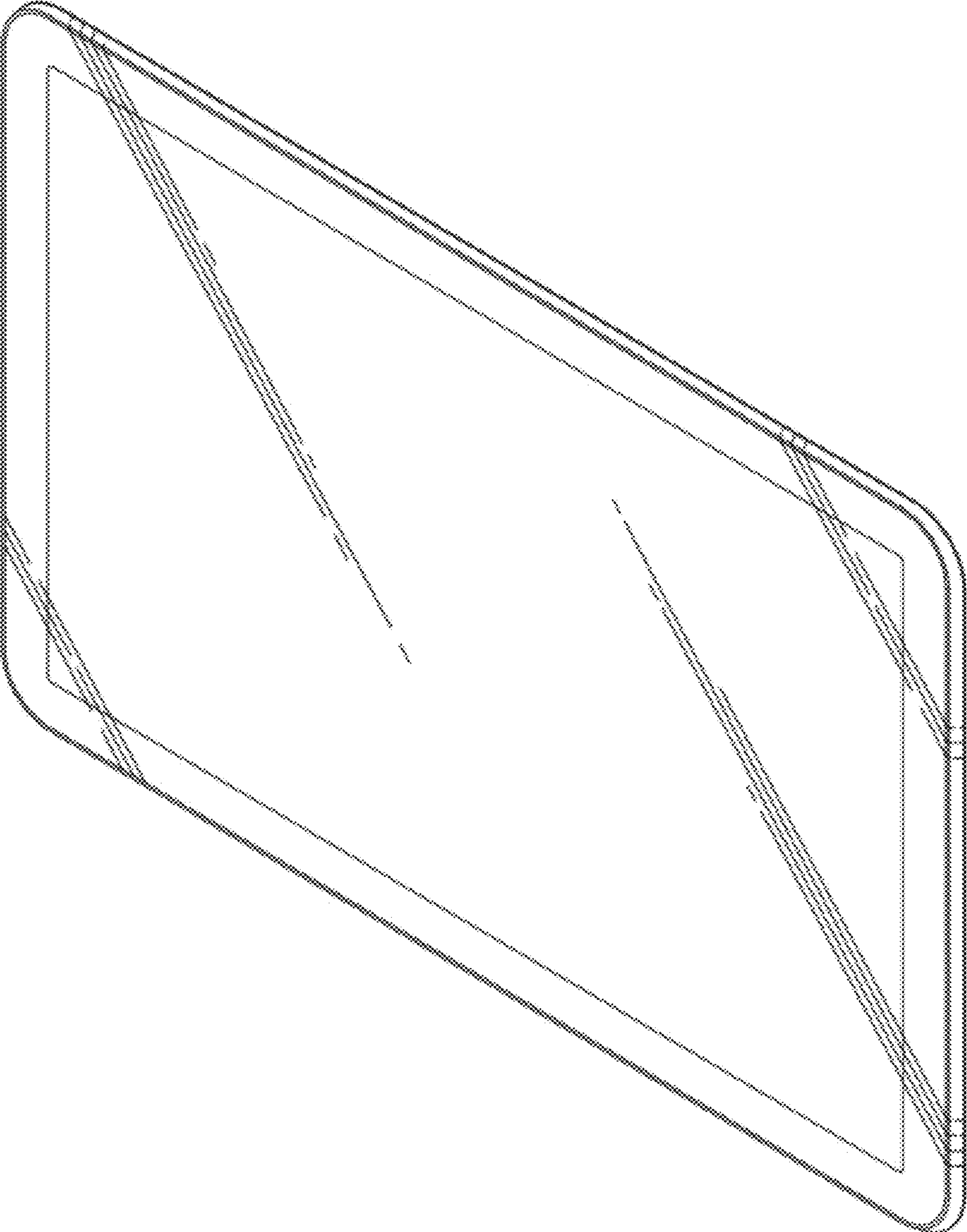

FIG. 2

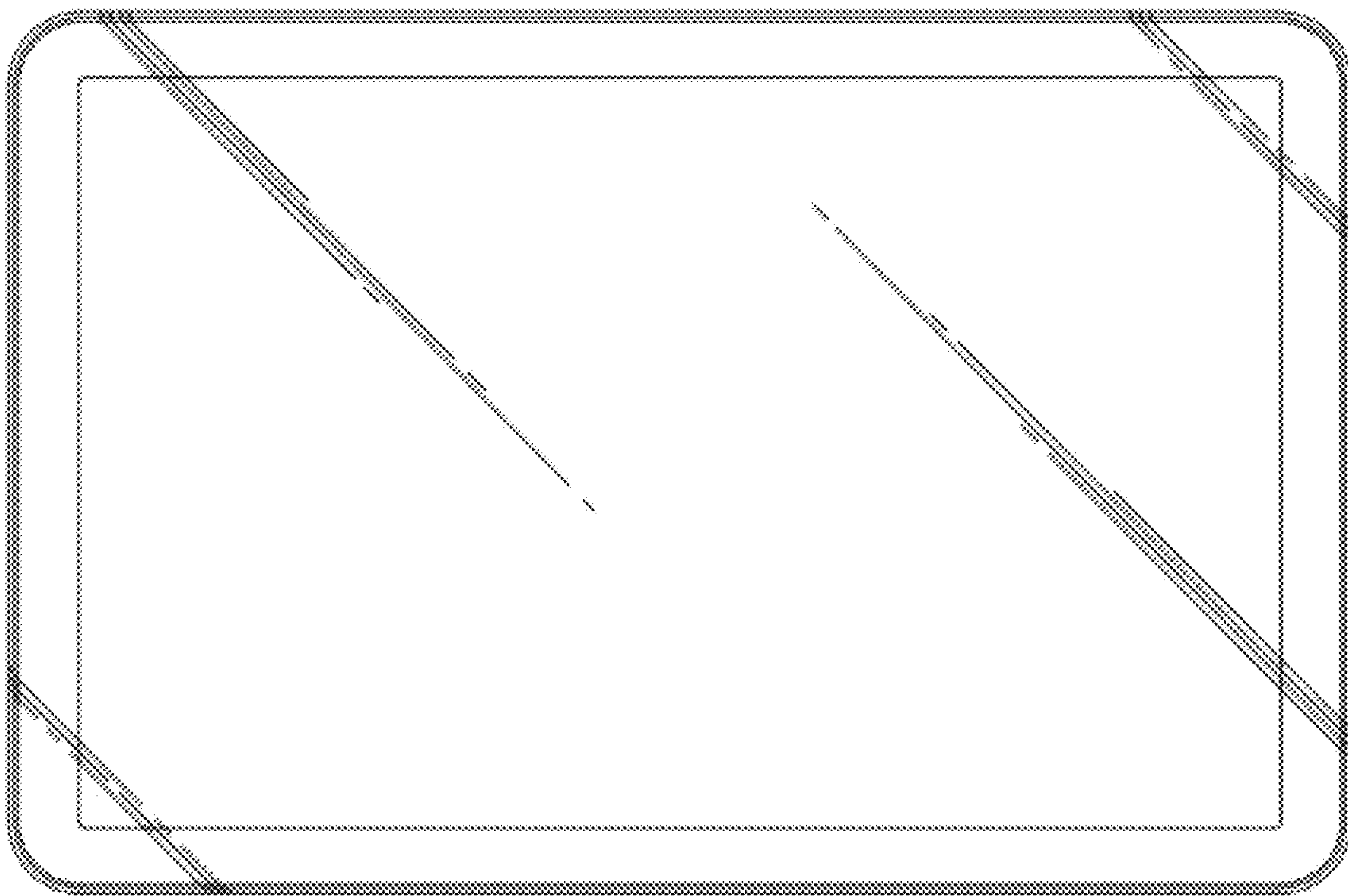

FIG. 3

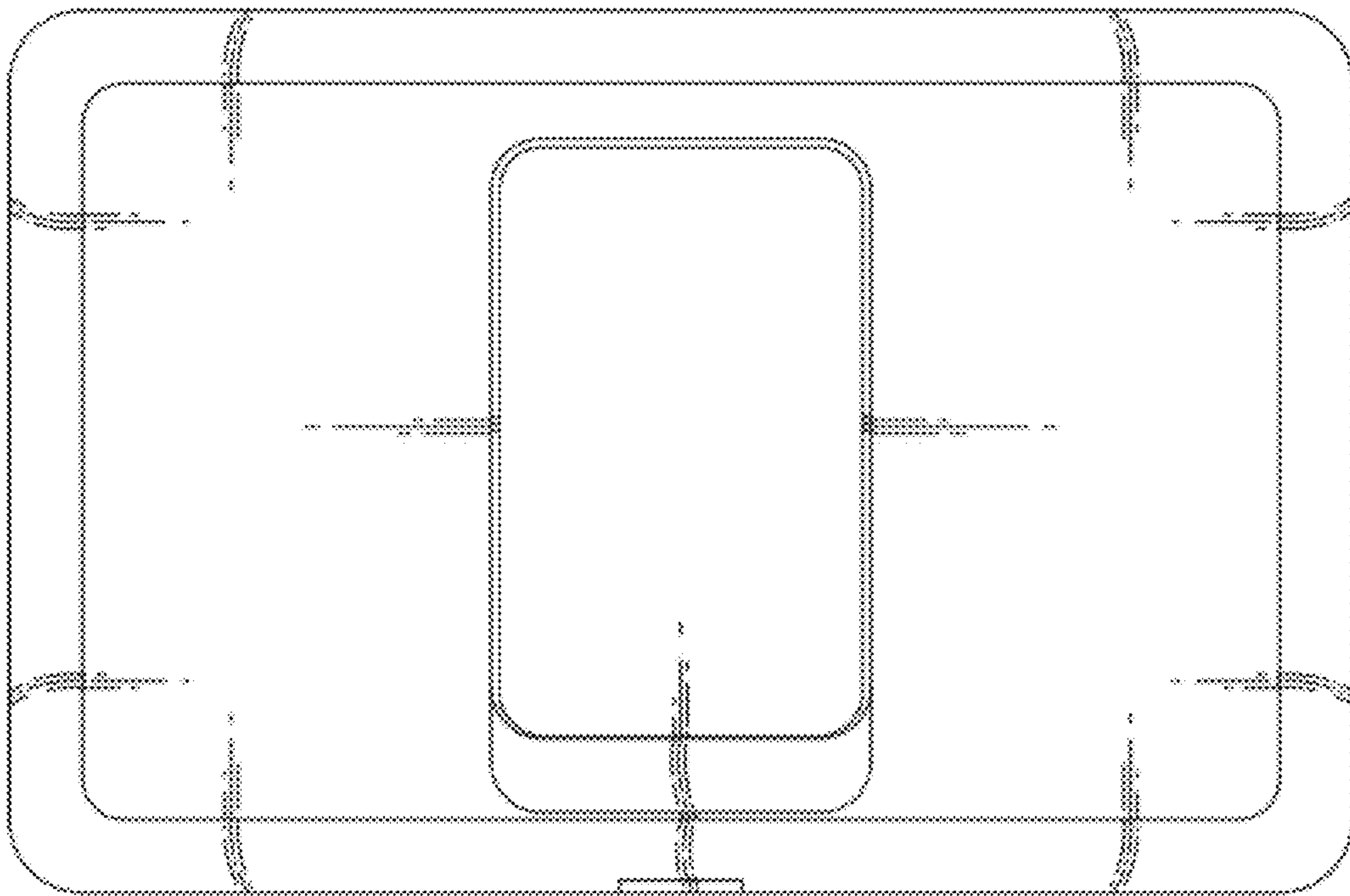

FIG. 4

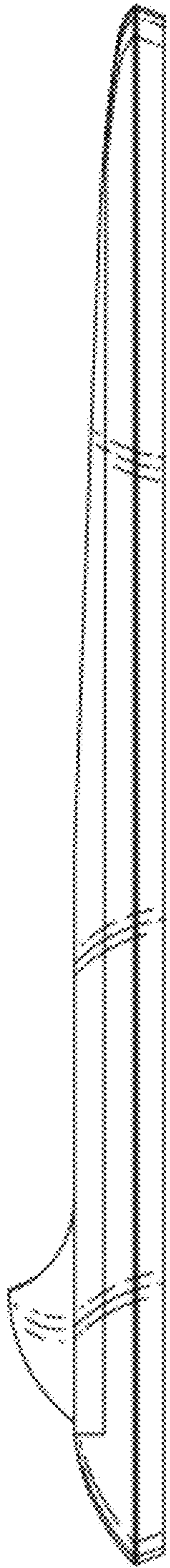

FIG. 5

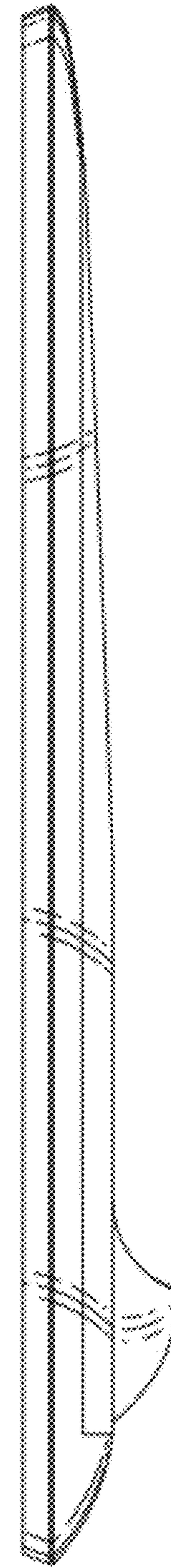

FIG. 6



FIG. 7

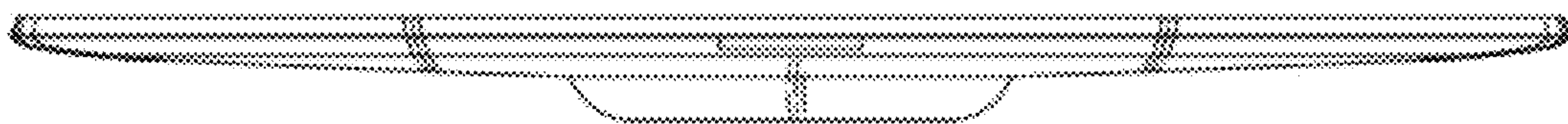

FIG. 8

