



US00D671903S

(12) **United States Design Patent**
Geum

(10) **Patent No.:** **US D671,903 S**

(45) **Date of Patent:** **** *Dec. 4, 2012**

(54) **MOBILE PHONE**

(75) Inventor: **Hye-Gyung Geum**, Seoul (KR)

(73) Assignee: **Samsung Electronics Co., Ltd.** (KR)

(*) Notice: This patent is subject to a terminal disclaimer.

(**) Term: **14 Years**

(21) Appl. No.: **29/407,709**

(22) Filed: **Dec. 1, 2011**

(30) **Foreign Application Priority Data**

Aug. 19, 2011 (KR) 30-2011-0034476

(51) **LOC (9) Cl.** **14-03**

(52) **U.S. Cl.** **D14/138 AA; D14/346**

(58) **Field of Classification Search** D14/138 AA,
D14/138 R, 138 C, 496, 346, 203.1, 203.4,
D14/203.7, 147, 148, 218, 426; D21/517;
455/575.1, 556.2; 379/433.01, 433.04; D13/168
See application file for complete search history.

(56) **References Cited**

U.S. PATENT DOCUMENTS

D488,810	S	*	4/2004	Lin et al.	D14/341
D563,378	S	*	3/2008	Tseng et al.	D14/138 AA
D573,128	S	*	7/2008	Lee et al.	D14/138 AA
D582,372	S	*	12/2008	Lee et al.	D14/138 AA
D593,556	S	*	6/2009	Hofer et al.	D14/346
D597,511	S	*	8/2009	Park	D14/138 AA
D600,231	S	*	9/2009	Lee et al.	D14/138 AA
D603,833	S	*	11/2009	Ho et al.	D14/138 AA
D607,866	S	*	1/2010	Kim et al.	D14/138 AA
D608,329	S	*	1/2010	Kim et al.	D14/138 AA
D612,849	S	*	3/2010	Ferrari et al.	D14/346

D614,159	S	*	4/2010	Lee et al.	D14/138 AA
D615,061	S	*	5/2010	Choi et al.	D14/138 AA
D615,088	S	*	5/2010	Matsuoka	D14/439
D622,247	S	*	8/2010	Kwon et al.	D14/138 AA
D626,105	S	*	10/2010	Kim et al.	D14/138 AA
D628,550	S	*	12/2010	Chen	D14/138 AA
D628,973	S	*	12/2010	Ku	D14/138 AA
D628,976	S	*	12/2010	Yang	D14/138 AA
D631,450	S	*	1/2011	Moss	D14/138 AA

(Continued)

OTHER PUBLICATIONS

Samsung Ch@t 220 telephone, announced May 2011, [online], [site visited Mar. 23, 2012]. Available from Internet, <URL: <http://www.gsmarena.com>>.*

(Continued)

Primary Examiner — Jeffrey D Asch

(74) *Attorney, Agent, or Firm* — NSIP Law

(57) **CLAIM**

The ornamental design for a mobile phone, as shown and described.

DESCRIPTION

FIG. 1 is a perspective view of a mobile phone;
FIG. 2 is a front view of the mobile phone of FIG. 1;
FIG. 3 is a rear view of the mobile phone of FIG. 1;
FIG. 4 is a left-side view of the mobile phone of FIG. 1;
FIG. 5 is a right-side view of the mobile phone of FIG. 1;
FIG. 6 is a top plan view of the mobile phone of FIG. 1;
FIG. 7 is a bottom plan view of the mobile phone of FIG. 1;
and,
FIG. 8 is a partial enlarged-perspective view (a-a', b-b', c-c', d-d') of FIG. 2 to more clearly depict a feature of my design.

1 Claim, 6 Drawing Sheets

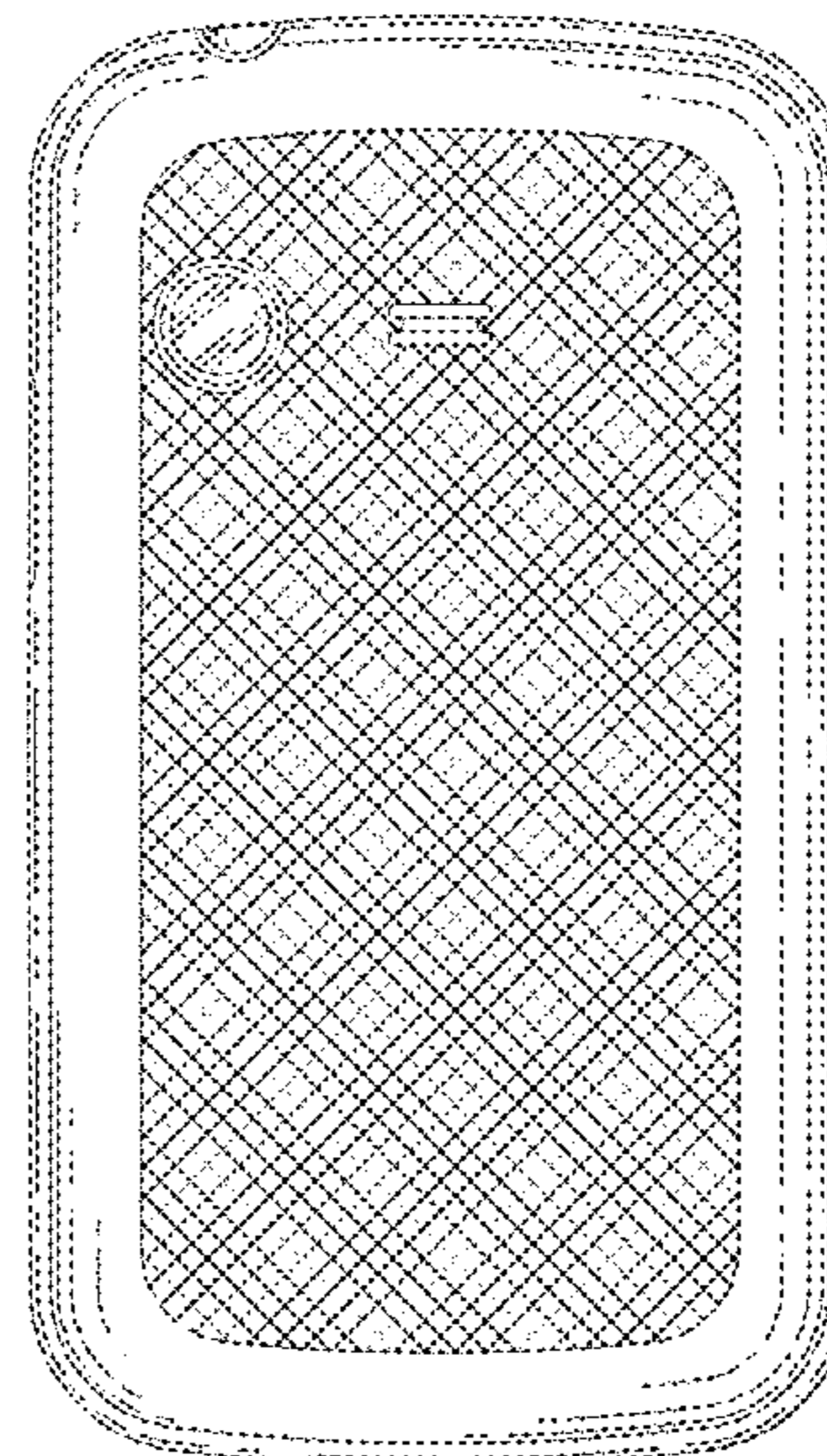
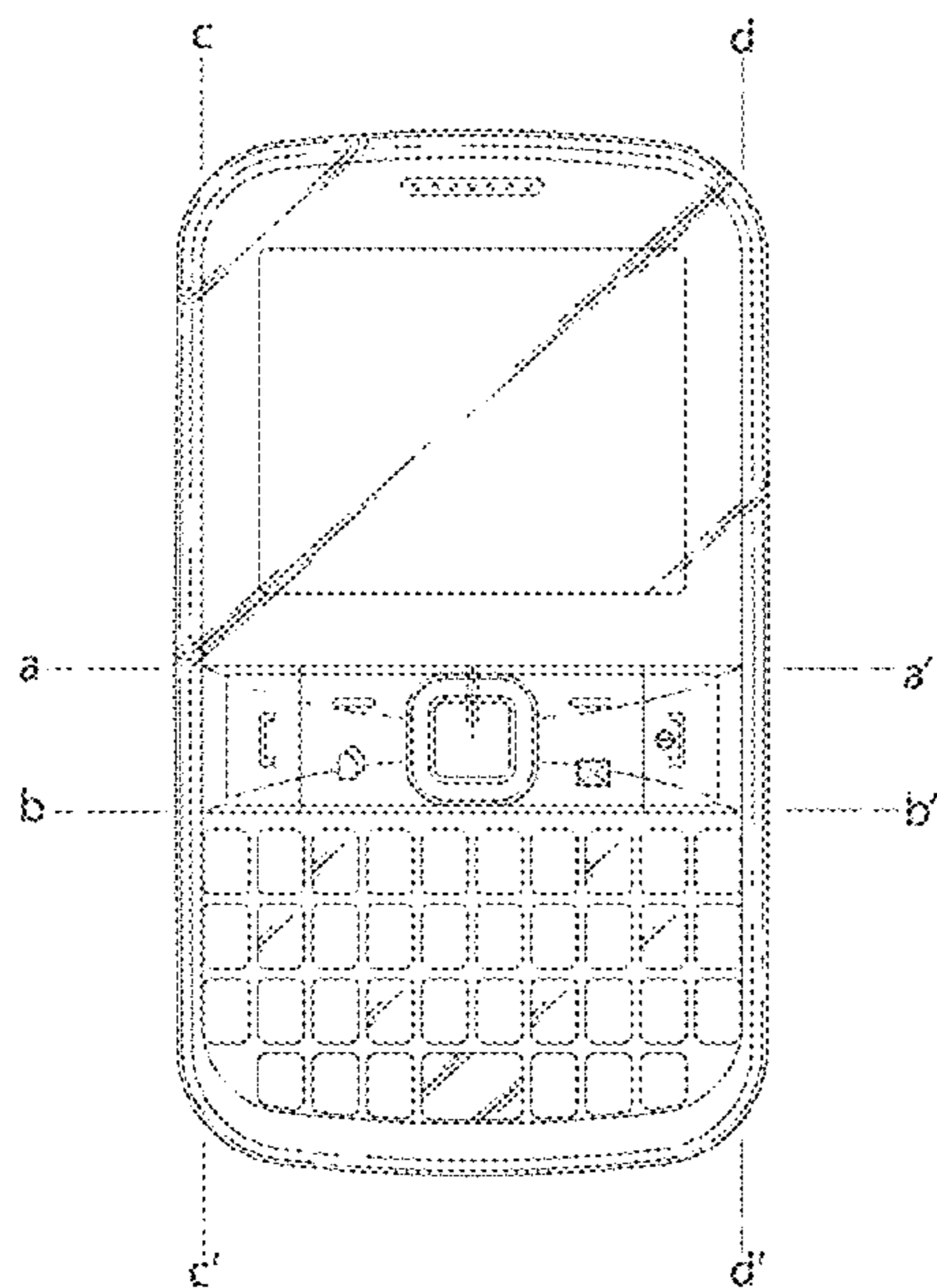

U.S. PATENT DOCUMENTS

D637,577 S * 5/2011 Han et al. D14/138 AA
D642,153 S * 7/2011 Nilsen et al. D14/138 AA
D647,869 S * 11/2011 Huang D14/138 AA
D647,870 S * 11/2011 Lee D14/138 AA
D648,302 S * 11/2011 Park et al. D14/138 AA
D648,304 S * 11/2011 Chen D14/138 AA
D649,134 S * 11/2011 Lee D14/138 AA
2009/0209301 A1 * 8/2009 Lin et al. 455/575.1
2010/0267426 A1 * 10/2010 Kang et al. 455/575.1
2011/0183729 A1 * 7/2011 Satou 455/575.1

OTHER PUBLICATIONS

Samsung Ch@t 222 telephone, announced May 2010, [online], [site visited Mar. 23, 2012]. Available from Internet, <URL: <http://www.gsmarena.com>>.*
Samsung R380 Freeform III telephone, announced Jul. 2011, [online], [site visited Mar. 23, 2012]. Available from Internet, <URL: <http://www.gsmarena.com>>.*

Samsung Ch@t 322 telephone, announced Oct. 2010, [online], [site visited Mar. 23, 2012]. Available from Internet, <URL: <http://www.gsmarena.com>>.*
Pantech Link telephone, announced Mar. 2010, [online], [site visited Mar. 23, 2012]. Available from Internet, <URL: <http://www.gsmarena.com>>.*
Blu Deco XT telephone, announced Jul. 2011, [online], [site visited Mar. 23, 2012]. Available from Internet, <URL: <http://www.gsmarena.com>>.*
Samsung Ch@t 527 telephone, announced Sep. 2011, [online], [site visited Mar. 23, 2012]. Available from Internet, <URL: <http://www.gsmarena.com>>.*
HTC Ozone telephone, announced Mar. 2009, [online], [site visited Mar. 23, 2012]. Available from Internet, <URL: <http://www.gsmarena.com>>.*
Huawei G6620 telephone, announced Jul. 2011, [online], [site visited Mar. 23, 2012]. Available from Internet, <URL: <http://www.gsmarena.com>>.*

* cited by examiner

FIG. 1

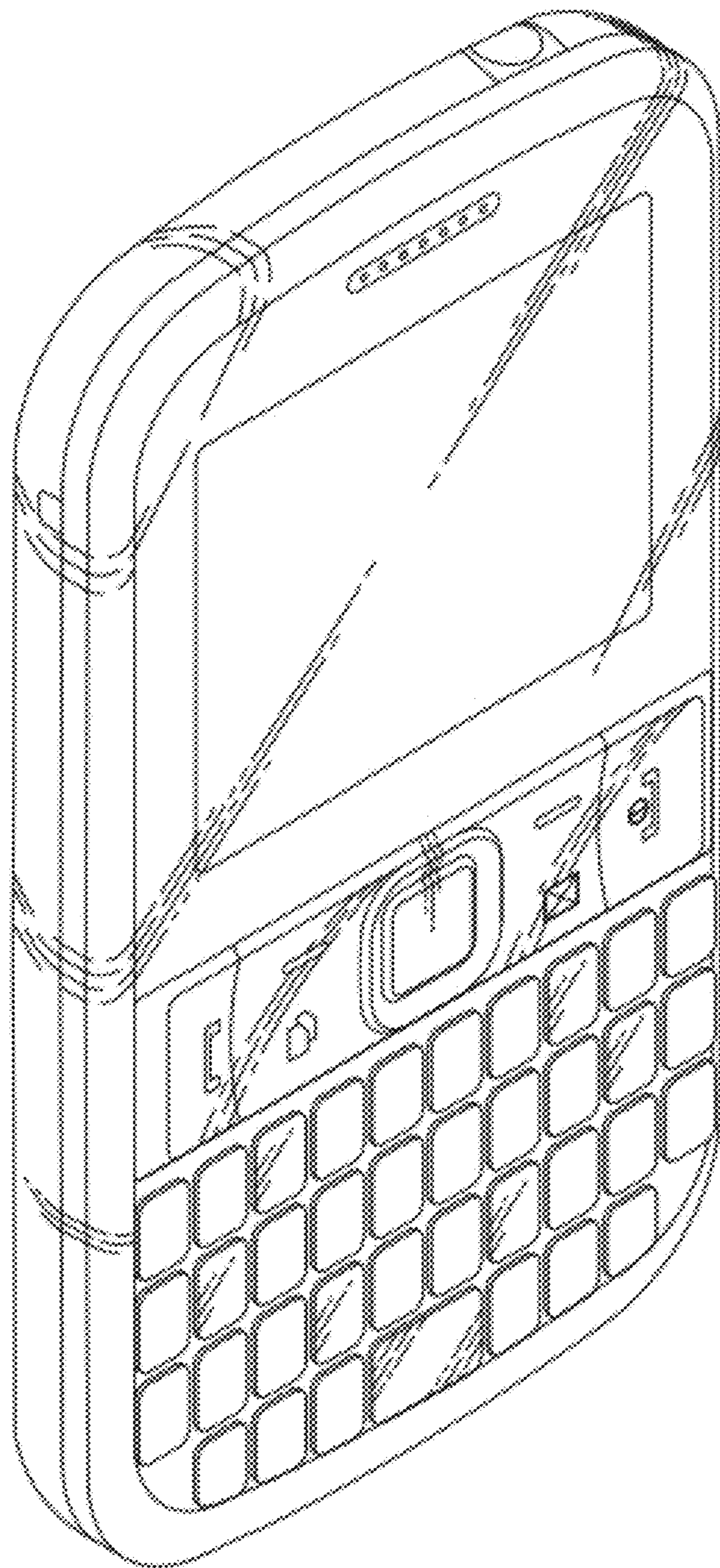

FIG. 2

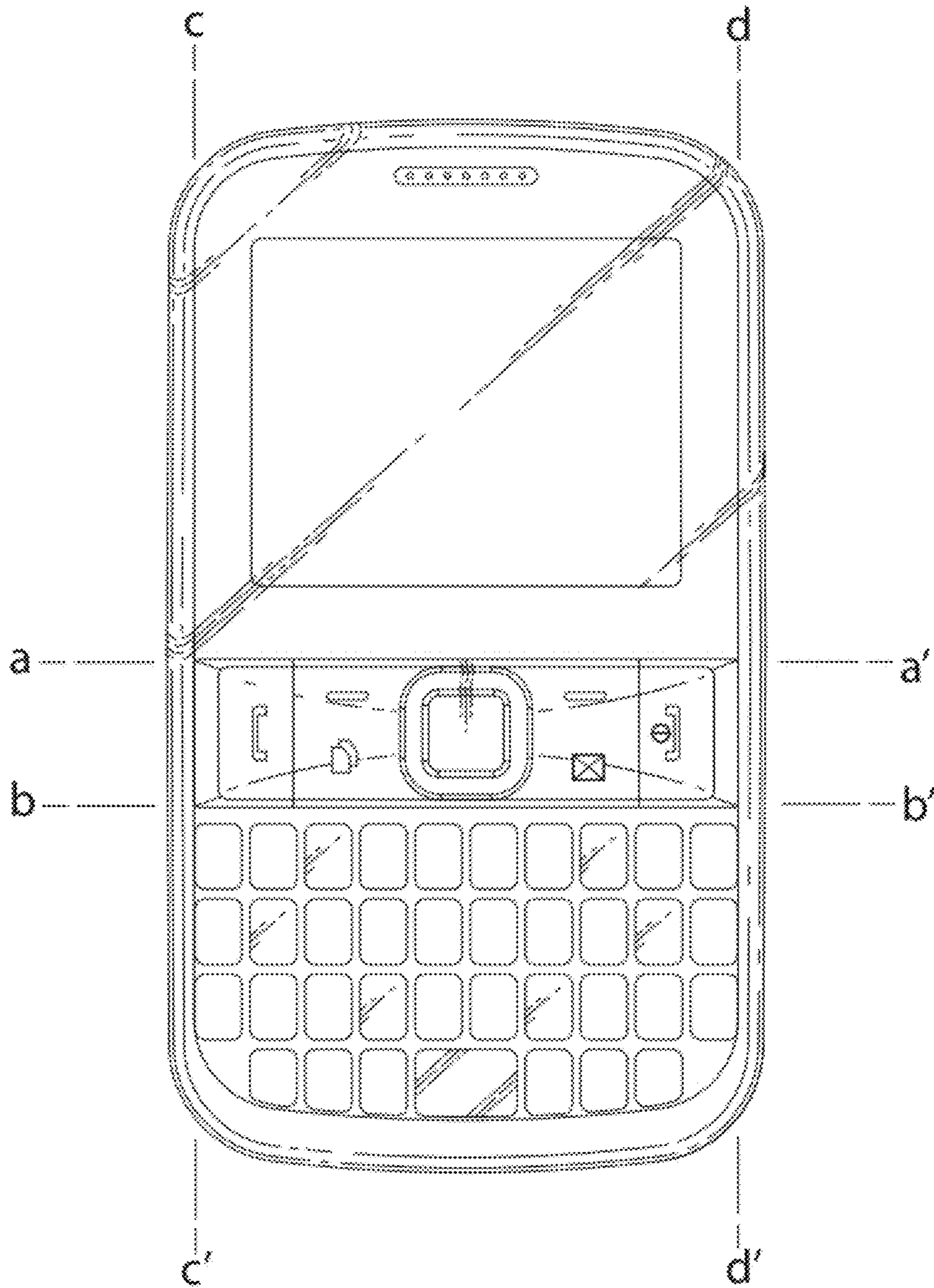

FIG. 3

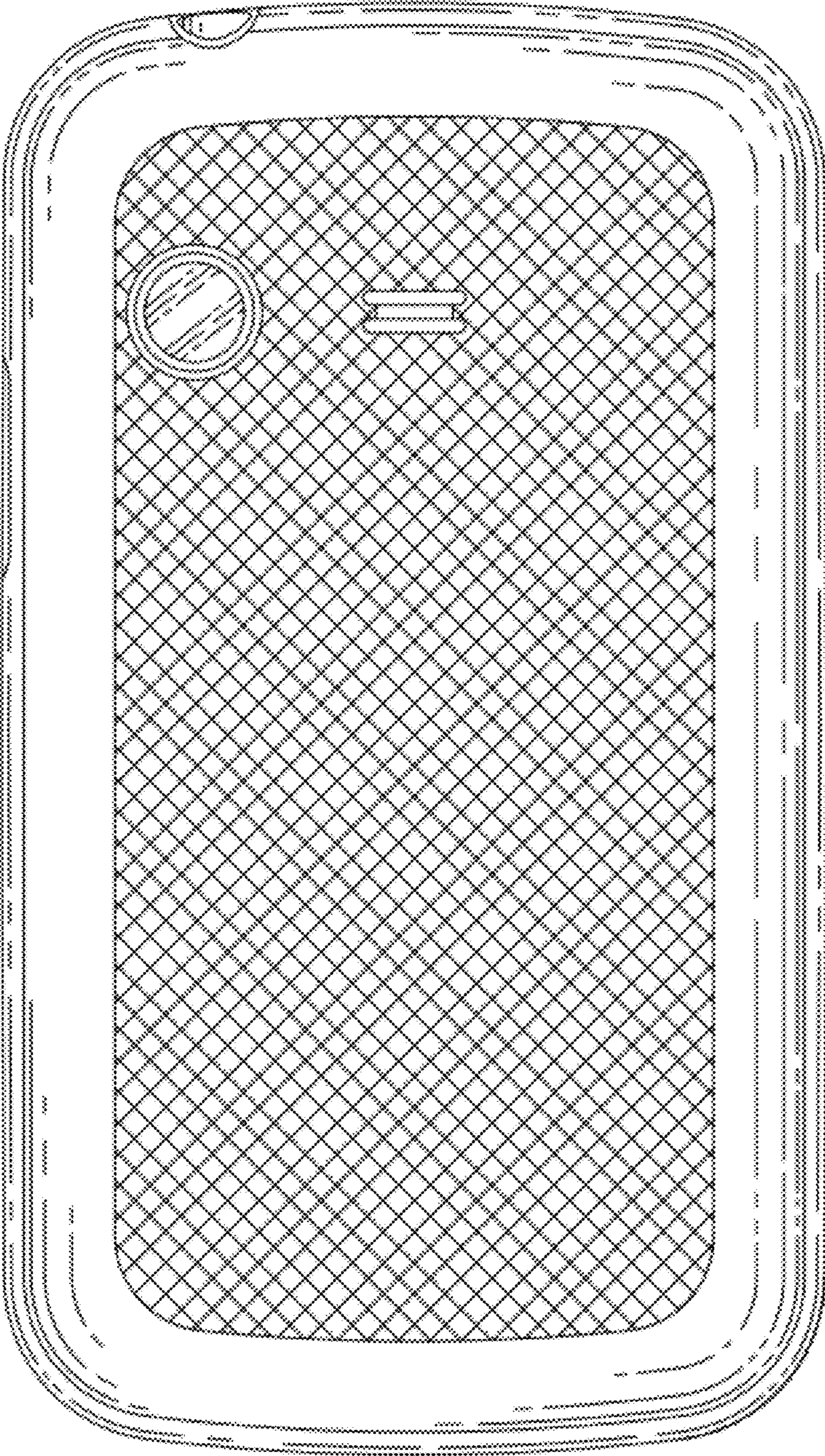

FIG. 4



FIG. 5

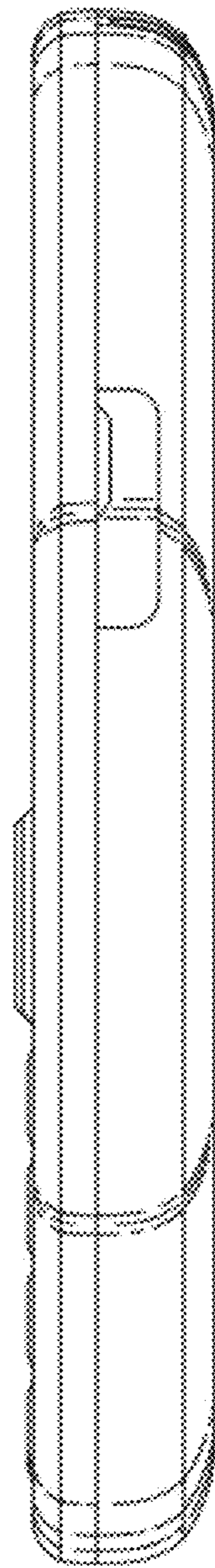

FIG. 6

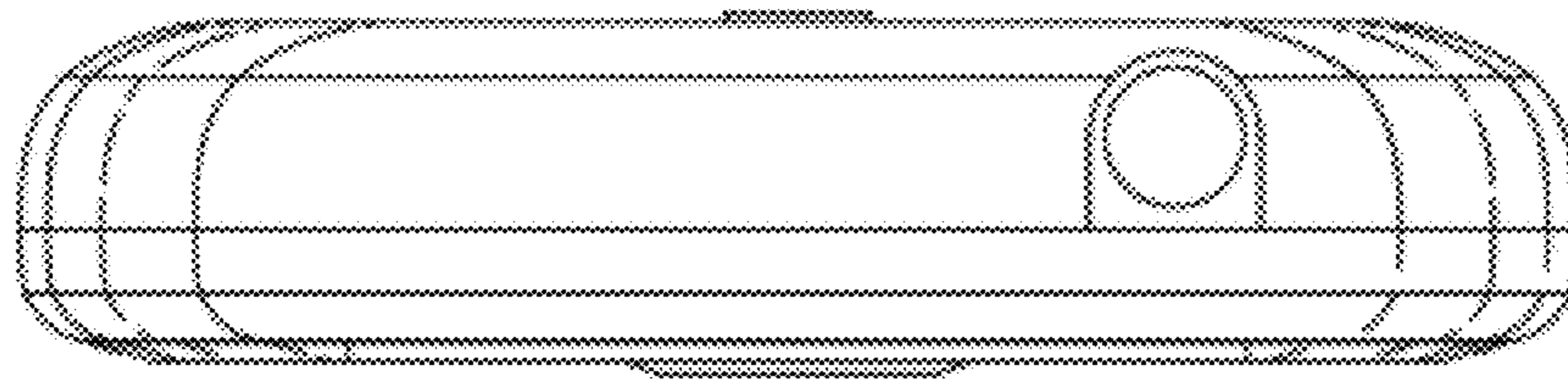

FIG. 7



FIG. 8

