



US00D671864S

(12) **United States Design Patent**
Keyaki et al.

(10) **Patent No.:** **US D671,864 S**
(45) **Date of Patent:** **** Dec. 4, 2012**

(54) **SLIDER FOR A SLIDE FASTENER**
(75) Inventors: **Keiichi Keyaki**, Toyama-ken (JP); **Yohei Miyazaki**, Toyama-ken (JP)

D629,333 S * 12/2010 Miyazaki et al. D11/221
D643,333 S 8/2011 Iwase
D653,170 S * 1/2012 Hamada et al. D11/221
D655,645 S * 3/2012 Gut D11/221

* cited by examiner

(73) Assignee: **YKK Corporation** (JP)

Primary Examiner — Ralf Seifert

(**) Term: **14 Years**

(74) *Attorney, Agent, or Firm* — Kilpatrick Townsend & Stockton LLP

(21) Appl. No.: **29/408,815**

(57) **CLAIM**

(22) Filed: **Dec. 16, 2011**

The ornamental design for a slider for a slide fastener, as shown and described.

(30) **Foreign Application Priority Data**

DESCRIPTION

Jun. 17, 2011 (JP) 2011-013740

(51) **LOC (9) Cl.** **02-07**

(52) **U.S. Cl.** **D11/221**

(58) **Field of Classification Search** D11/200,
D11/201, 221; 24/381–383, 385–387, 414–417,
24/421–422, 427–431, 433; 2/265

See application file for complete search history.

FIG. 1 is a perspective view of the bottom, front and right side of a slider for a slide fastener showing my (our) new design; FIG. 2 is a front view thereof; FIG. 3 is a rear view thereof; FIG. 4 is a right side view thereof; the left side view being mirror image thereof; FIG. 5 is a top plan view thereof; FIG. 6 is a bottom view thereof; and, FIG. 7 is a reference view of usage.

The portions of the article depicted in broken lines are shown for illustrative purposes only and form no part of the claimed design.

(56) **References Cited**

U.S. PATENT DOCUMENTS

D509,770 S 9/2005 Hamada et al.
D579,379 S * 10/2008 Lin D11/221
D627,259 S 11/2010 Miyazaki et al.

1 Claim, 6 Drawing Sheets

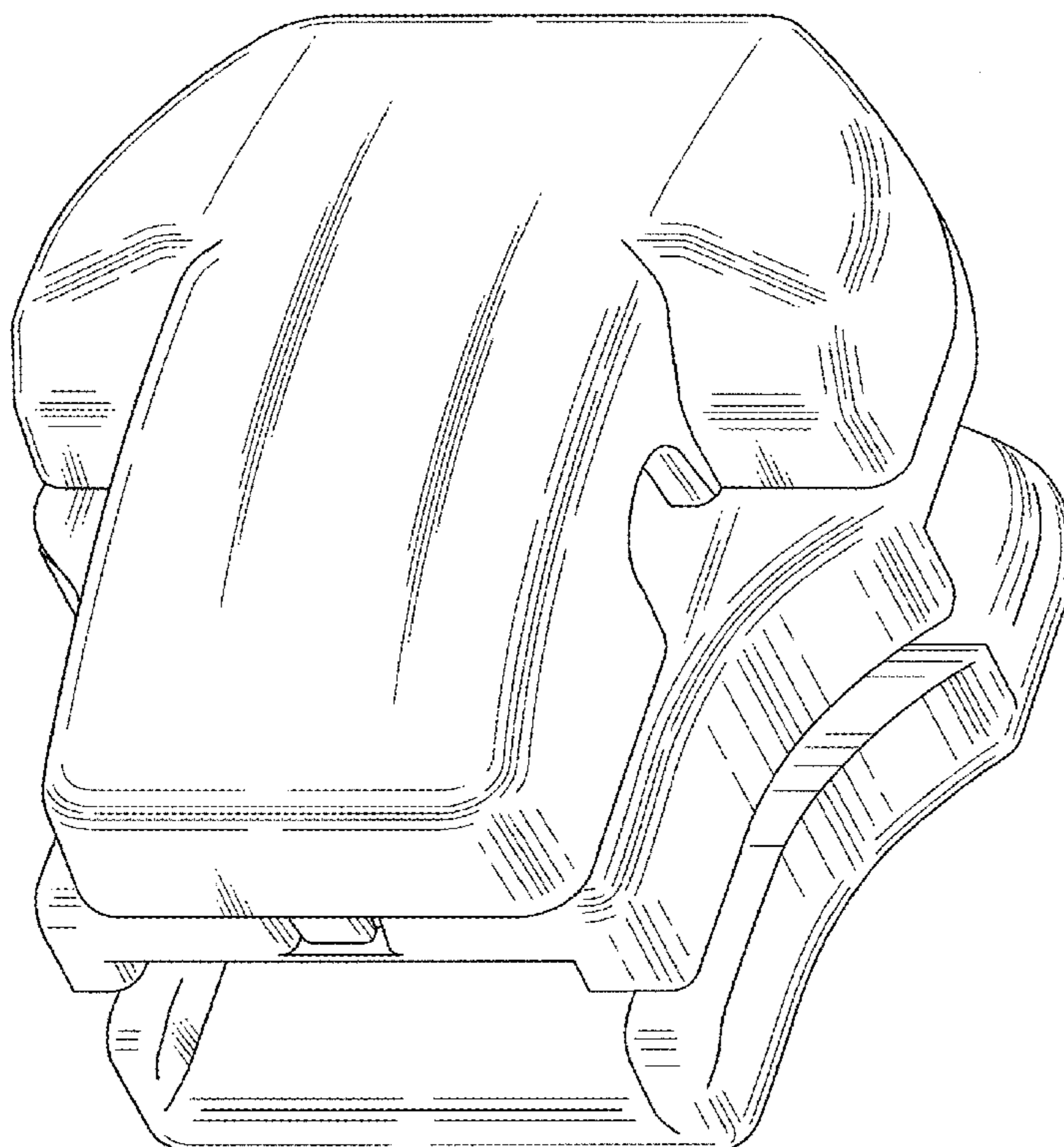

Fig. 1

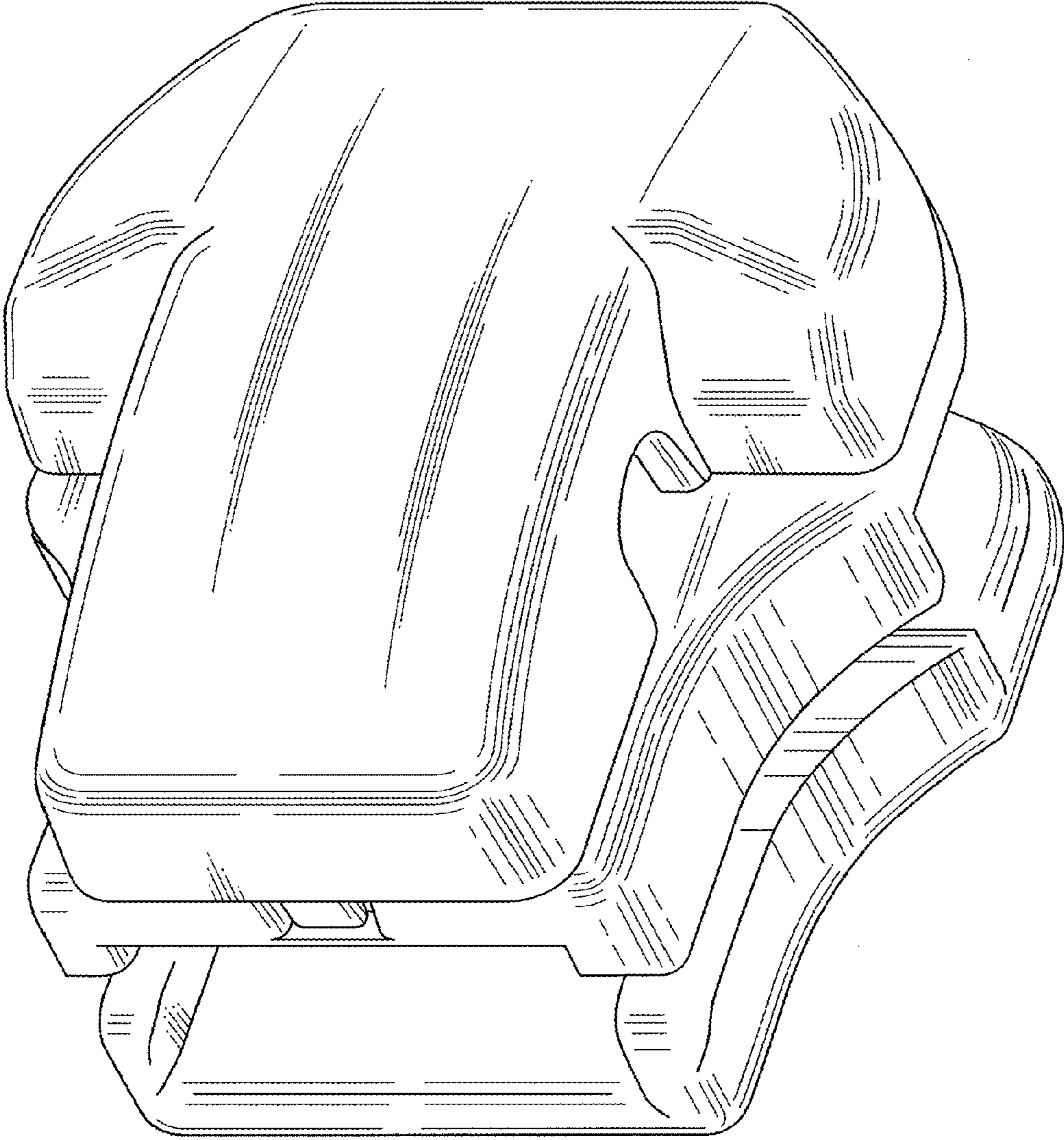

Fig. 2

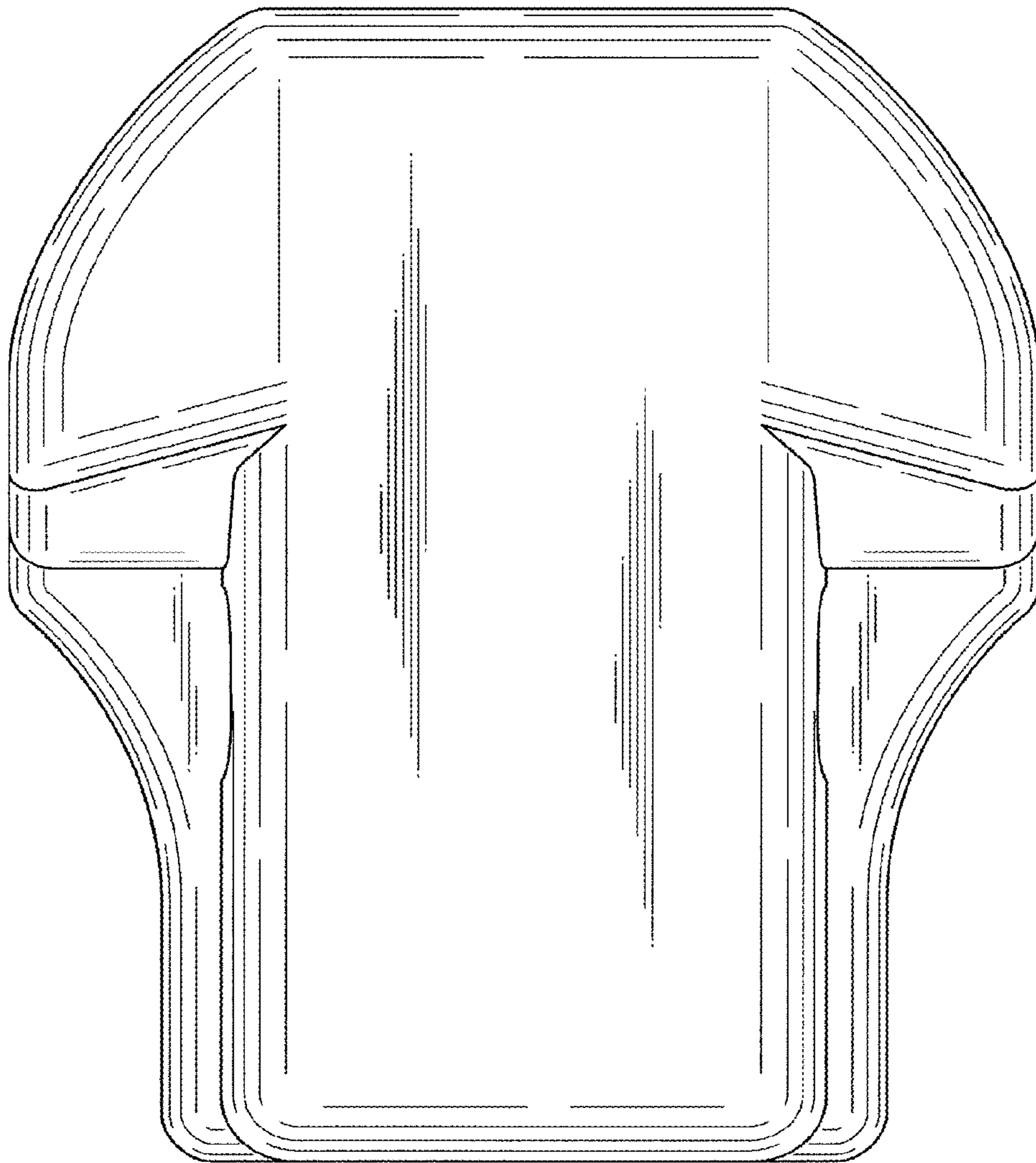

Fig. 3

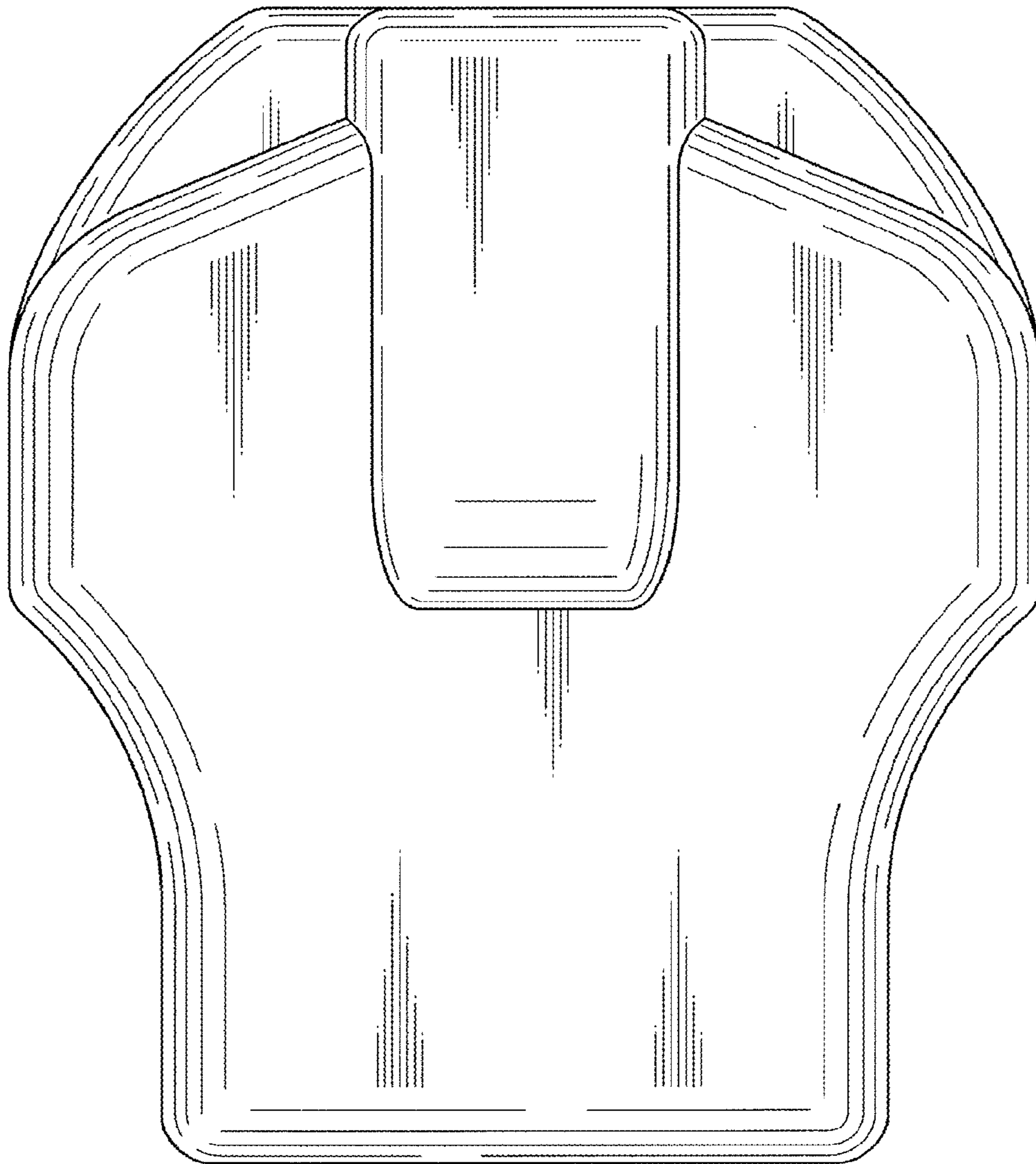

Fig. 4

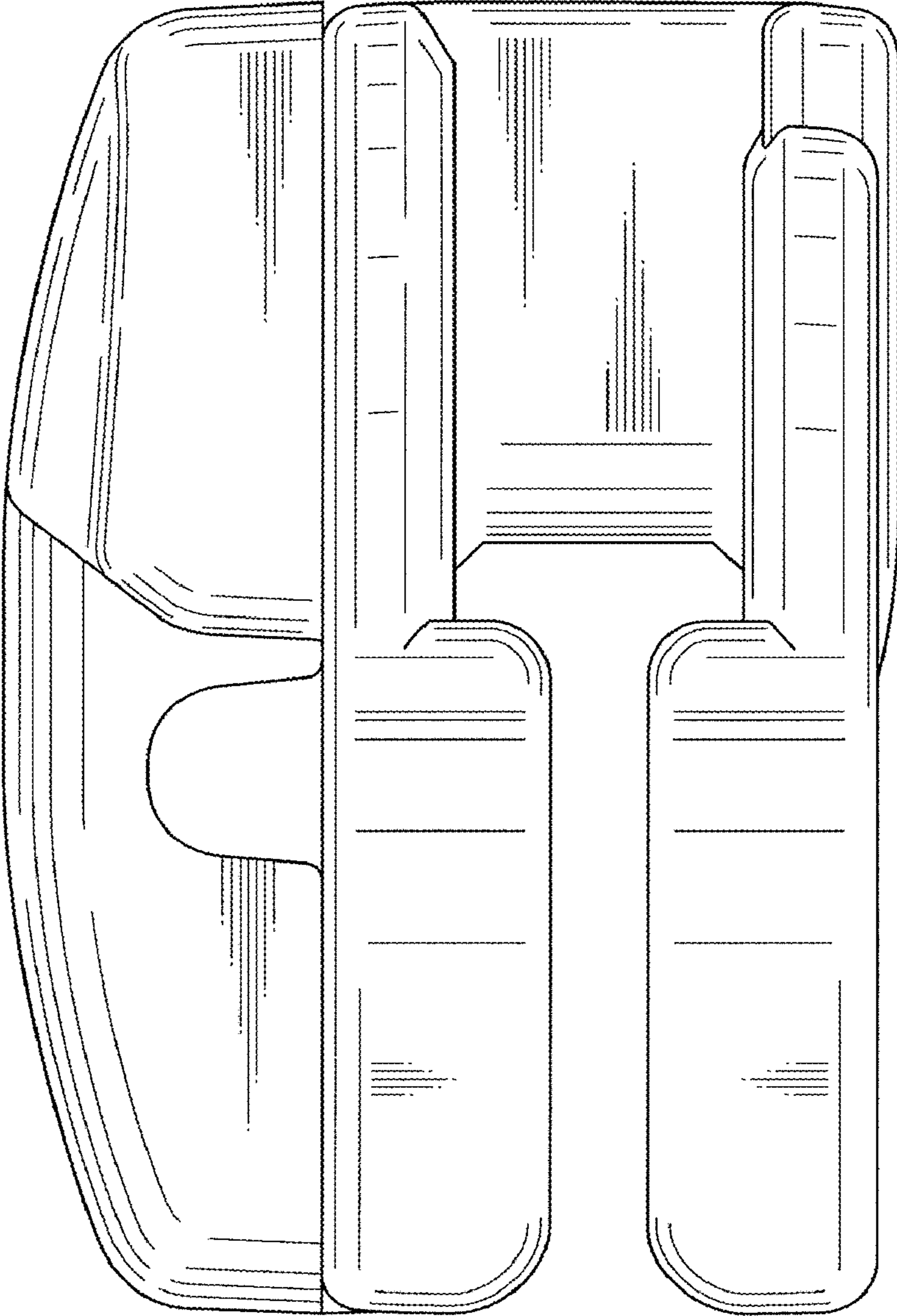

Fig. 5

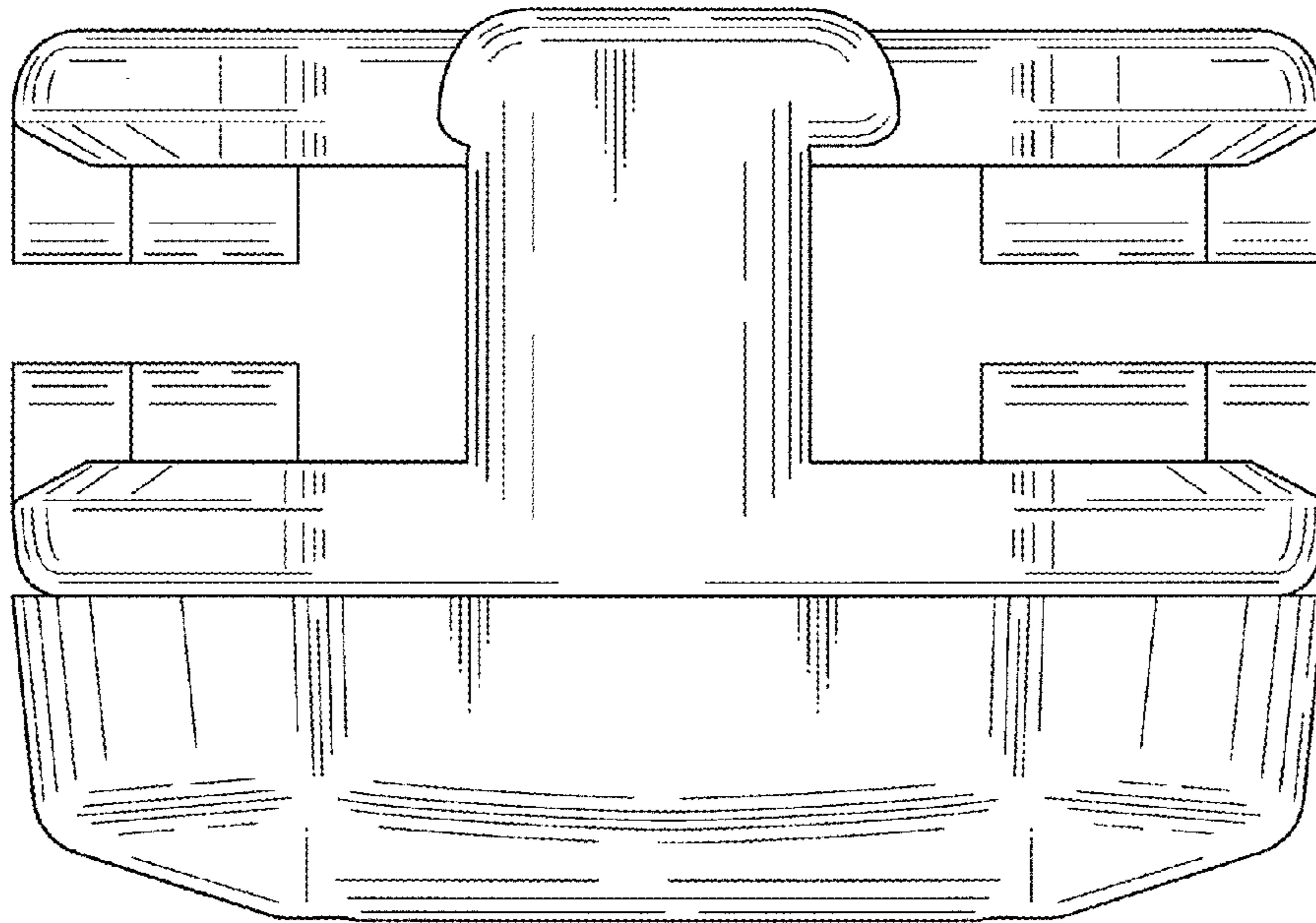

Fig. 6

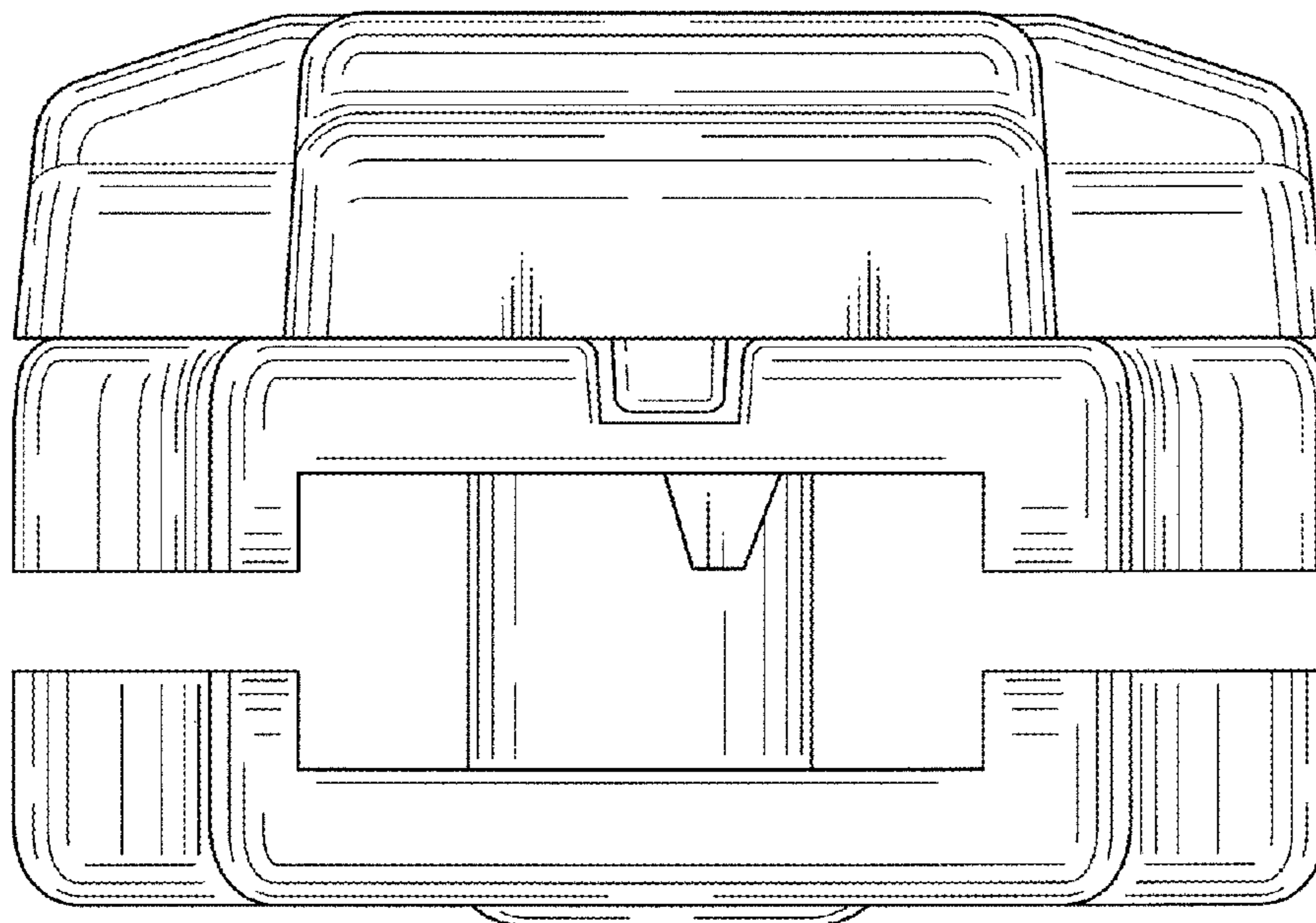

Fig. 7

