



US00D671844S

(12) **United States Design Patent**
Wright

(10) **Patent No.:** **US D671,844 S**

(45) **Date of Patent:** **** Dec. 4, 2012**

(54) **CUCKOO CLOCK**

(76) Inventor: **Kevin Wright**, Lower Brule, SD (US)

(**) Term: **14 Years**

(21) Appl. No.: **29/419,623**

(22) Filed: **Apr. 30, 2012**

(51) **LOC (9) Cl.** **10-01**

(52) **U.S. Cl.** **D10/8; D10/11**

(58) **Field of Classification Search** D10/1-29;
D11/157, 160, 161; 368/272, 273, 229, 316,
368/317

See application file for complete search history.

5,311,488 A *	5/1994	Trantham	368/250
D355,856 S *	2/1995	Dawson	D10/11
D384,289 S *	9/1997	Chan	D10/11
D390,472 S *	2/1998	Holt	D10/6
D391,173 S *	2/1998	Wang	D10/7
D407,023 S *	3/1999	Kuo	D10/8
D407,024 S *	3/1999	Kuo	D10/8
D439,845 S *	4/2001	Poandl	D10/8
D442,871 S *	5/2001	Moore	D10/8
D444,073 S *	6/2001	Liao	D10/11

* cited by examiner

Primary Examiner — Lucy Lieberman

(74) *Attorney, Agent, or Firm* — Gordon & Rees LLP

(57) **CLAIM**

The ornamental design for a cuckoo clock device, as shown and described.

(56) **References Cited**

U.S. PATENT DOCUMENTS

D37,919 S *	3/1906	Wolfstein	D10/54
D53,226 S *	4/1919	Scott	D11/131.1
D94,361 S *	1/1935	Roth	D10/11
D94,829 S *	3/1935	Gottlieb	D10/8
D120,511 S *	5/1940	Lux	D10/9
D165,223 S *	11/1951	Eickemeyer	D10/8
D168,052 S *	10/1952	Koplar	D10/8
D210,742 S *	4/1968	Appel et al.	D10/8
4,098,068 A *	7/1978	Masuyama	368/272
D295,384 S *	4/1988	Apker	D10/11
4,993,006 A *	2/1991	Oshima et al.	368/231
D321,659 S *	11/1991	Nomura et al.	D10/8
D322,406 S *	12/1991	Nomura	D10/6
D336,856 S *	6/1993	Chen	D10/8

DESCRIPTION

FIG. 1 is a perspective view of the cuckoo clock with the figurines in a first position.

FIG. 2 is a perspective view of the cuckoo clock with the figurines in a second position.

FIG. 3 is a top plan view corresponding to FIG. 2.

FIG. 4 is a left side elevation view corresponding to FIG. 2.

FIG. 5 is a right side elevation view corresponding to FIG. 2.

FIG. 6 is a front elevation view corresponding to FIG. 2; and,

FIG. 7 is a back elevation view corresponding to FIG. 2.

The broken lines showing are for illustrative purposes and forms no part of the claimed design.

1 Claim, 7 Drawing Sheets

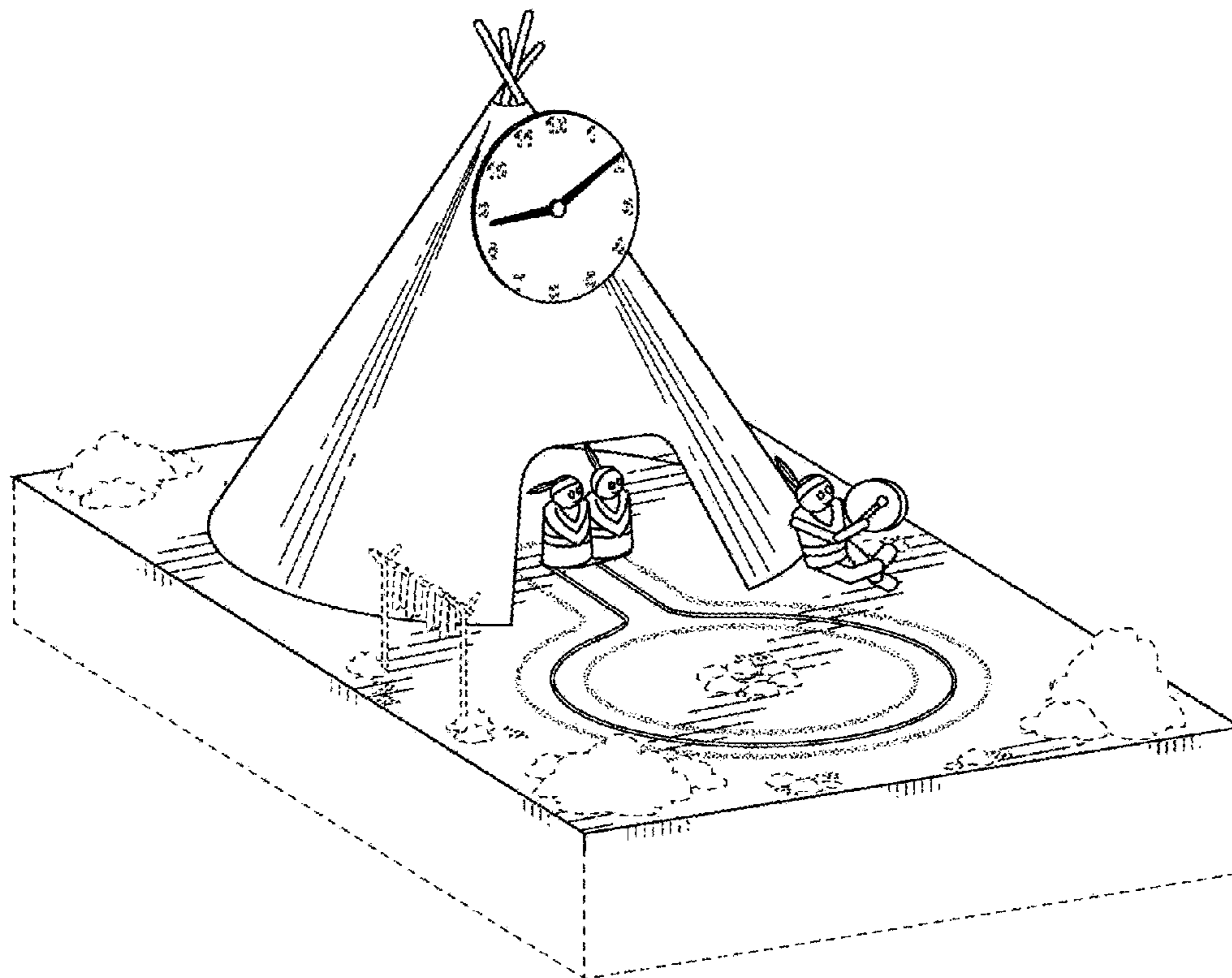

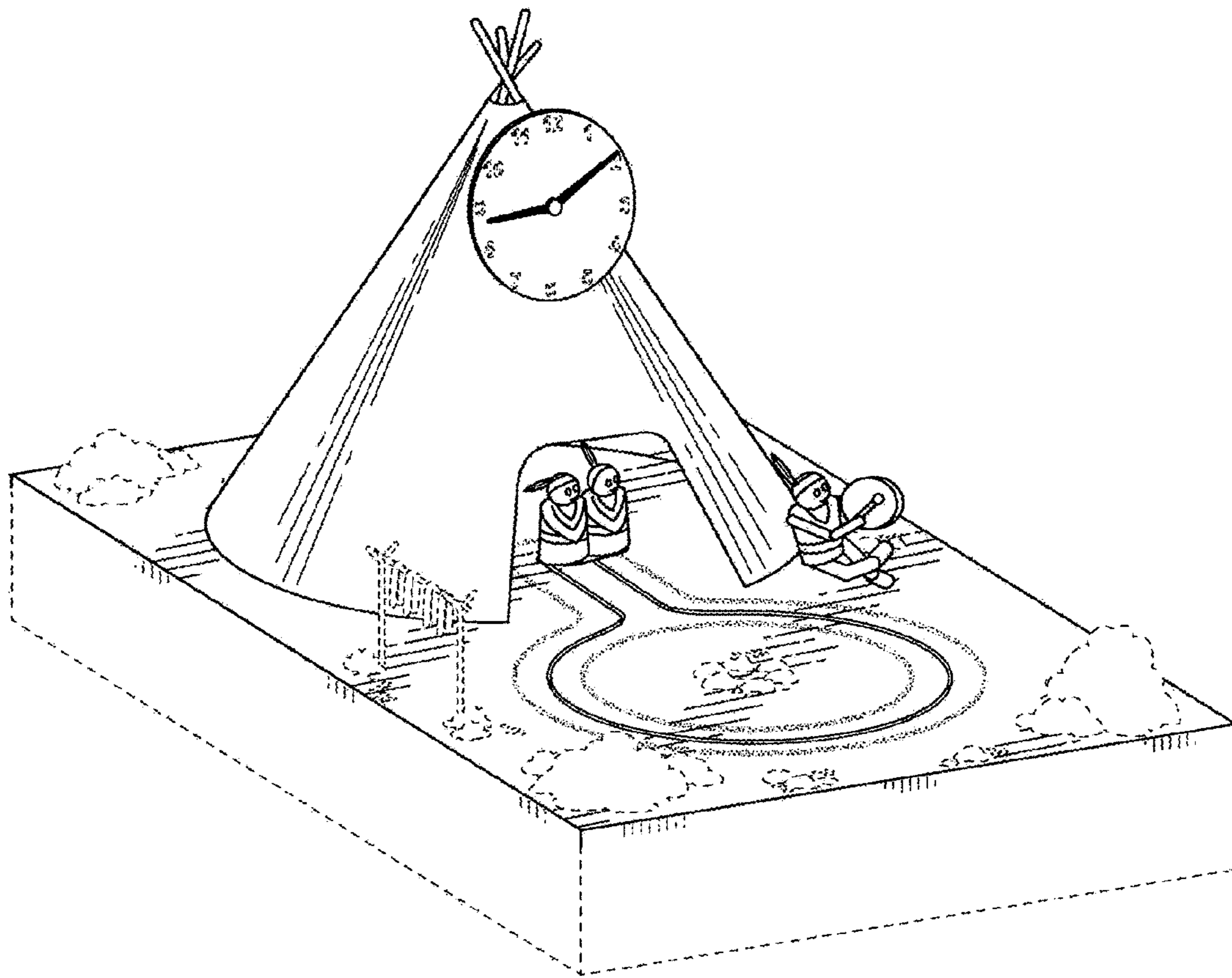

FIG. 1

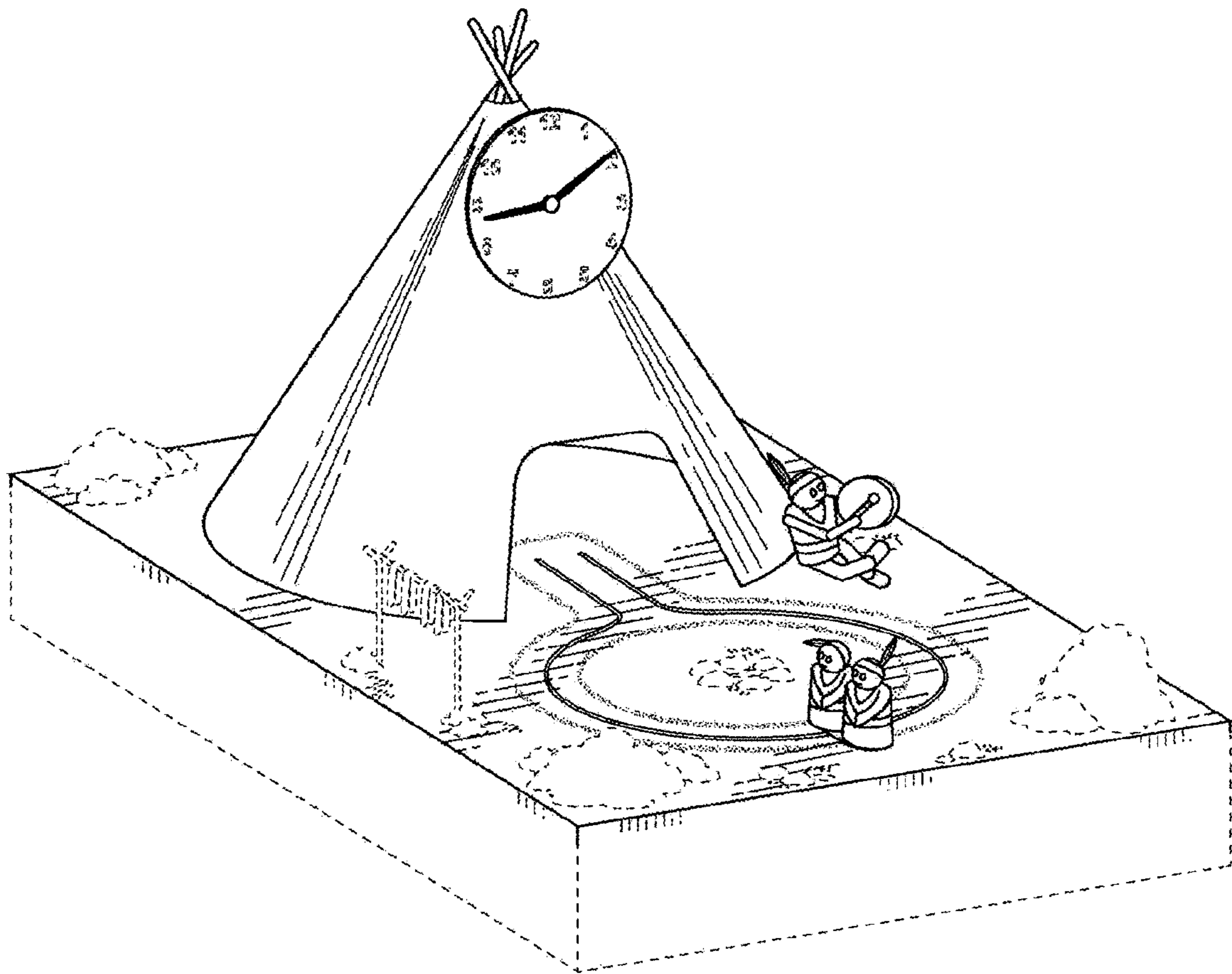

FIG. 2

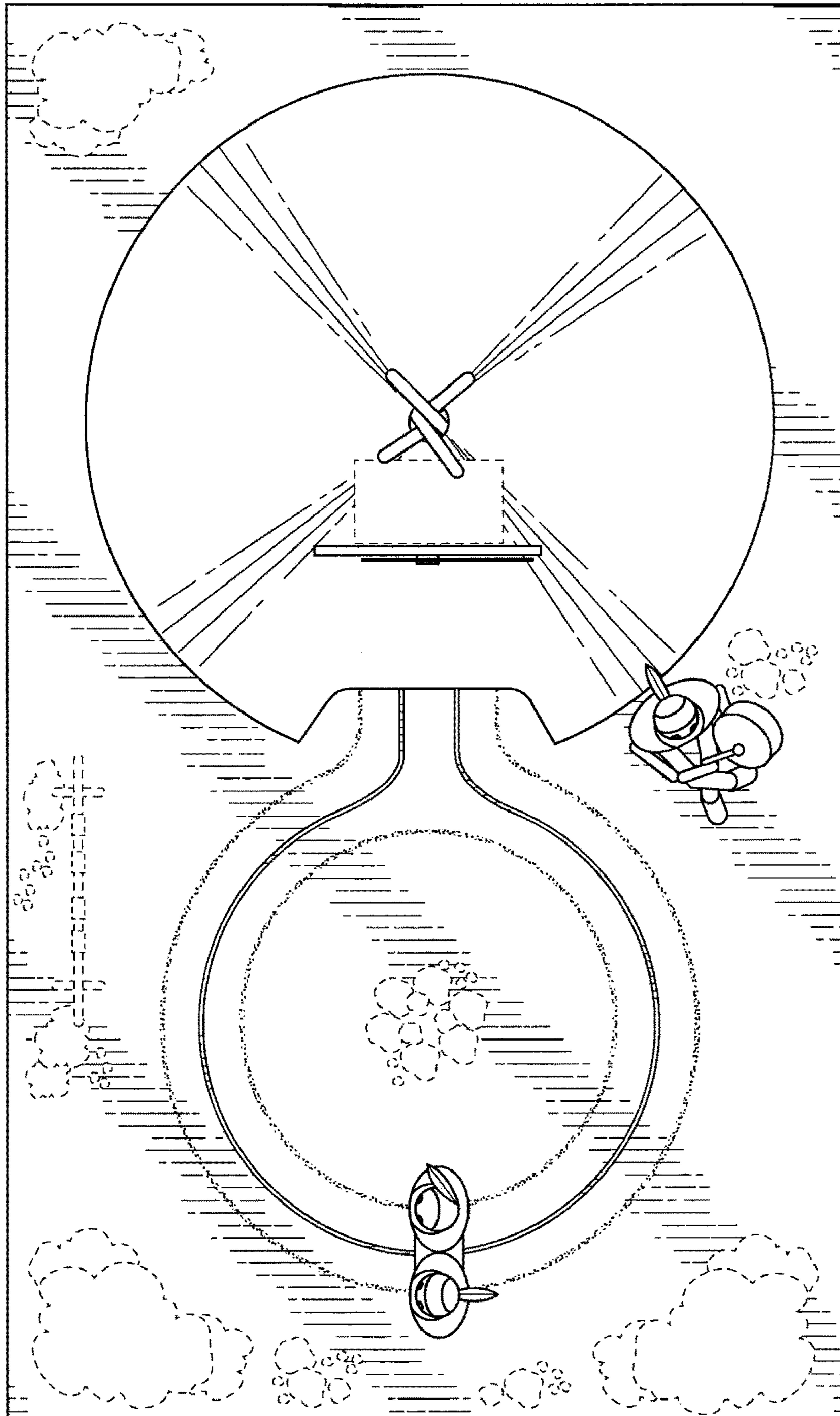

FIG. 3

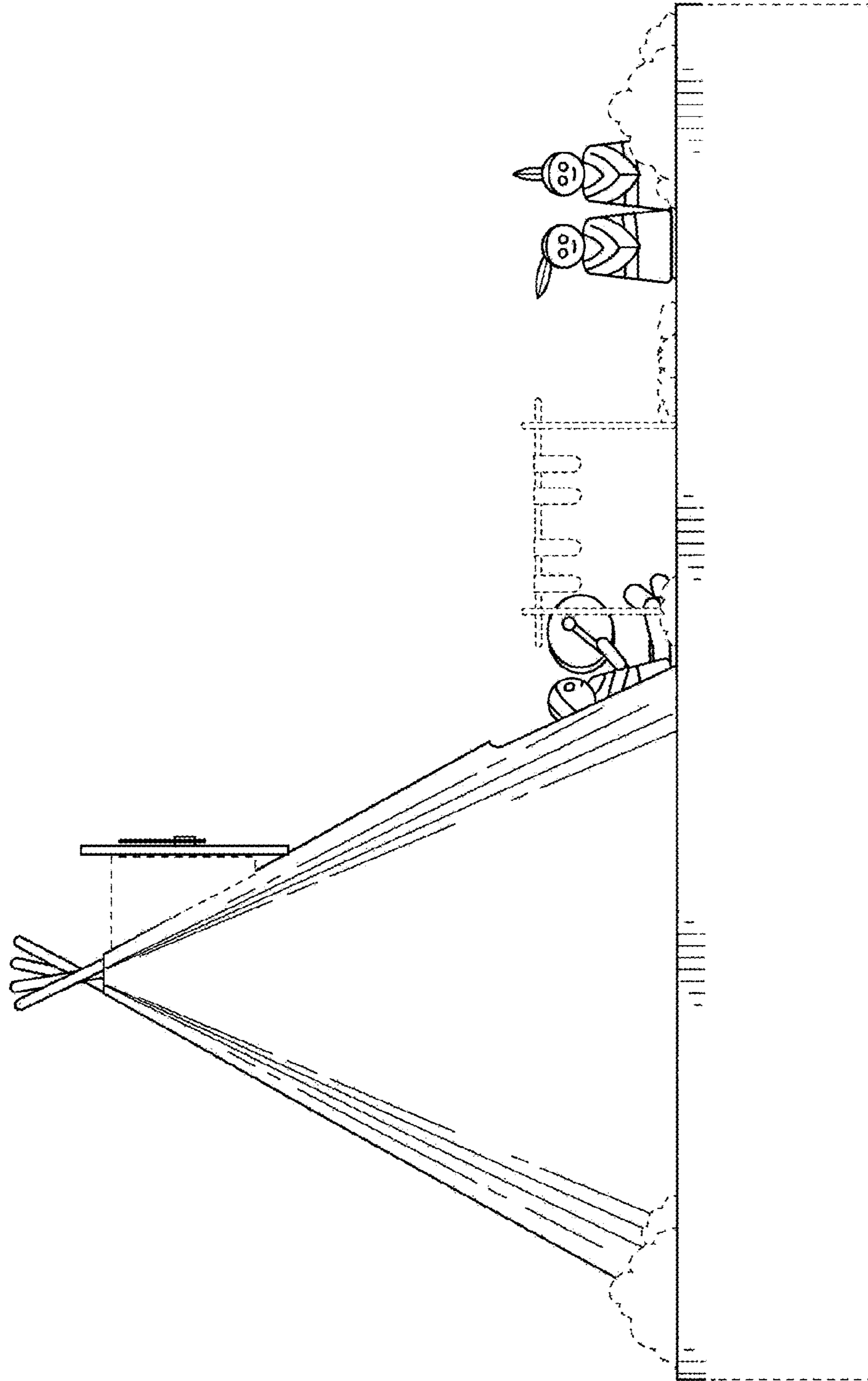

FIG. 4

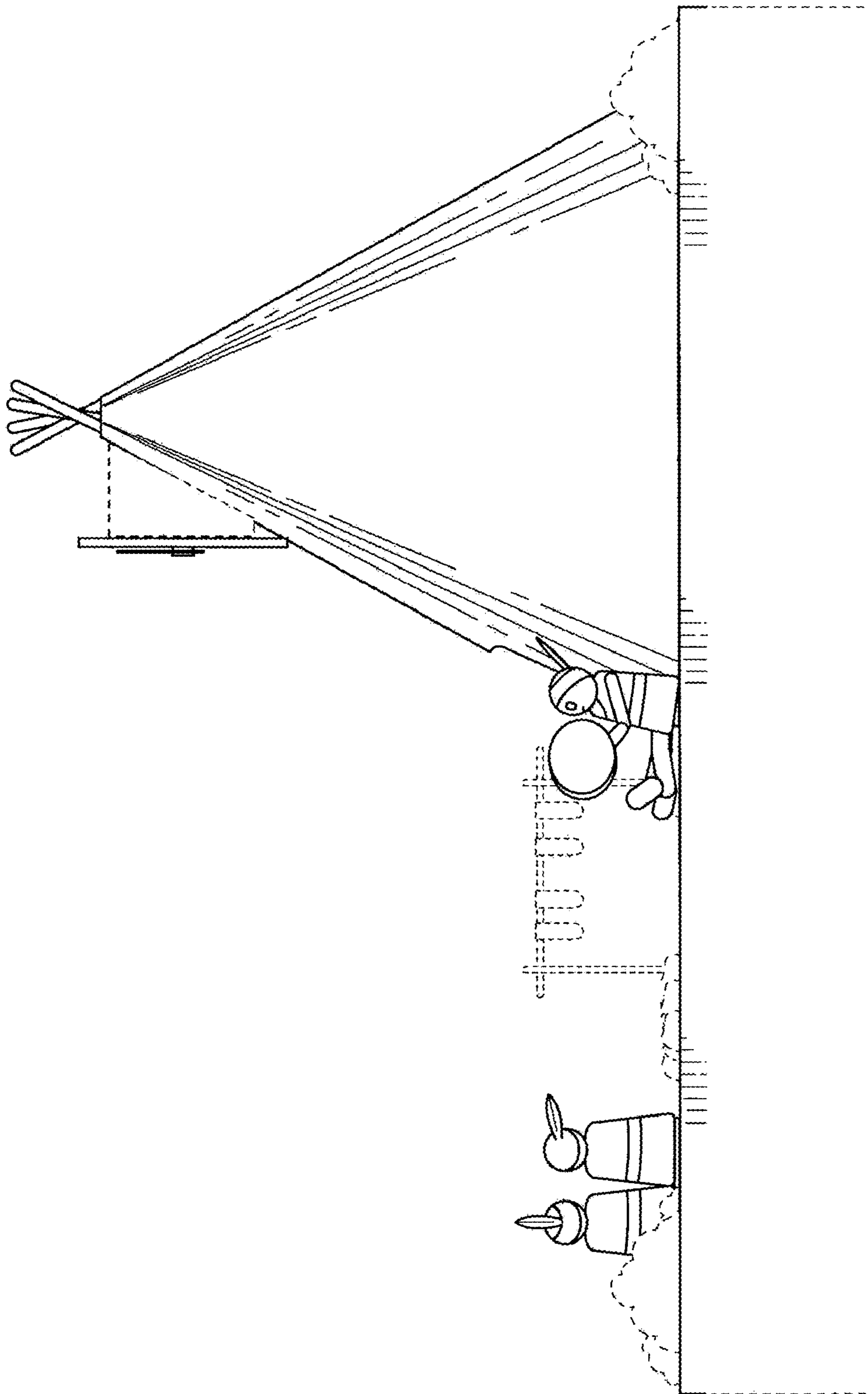

FIG. 5

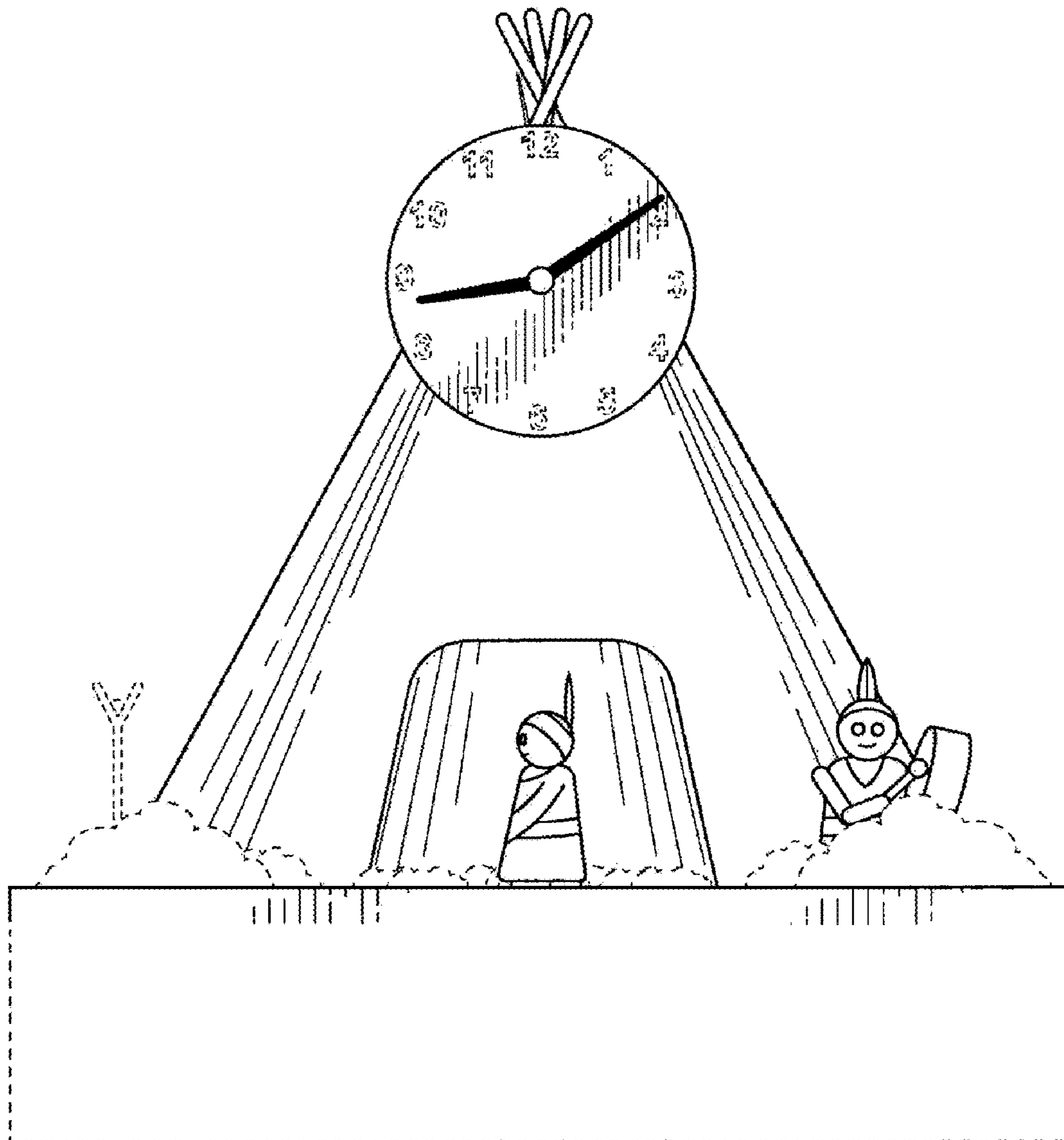

FIG. 6

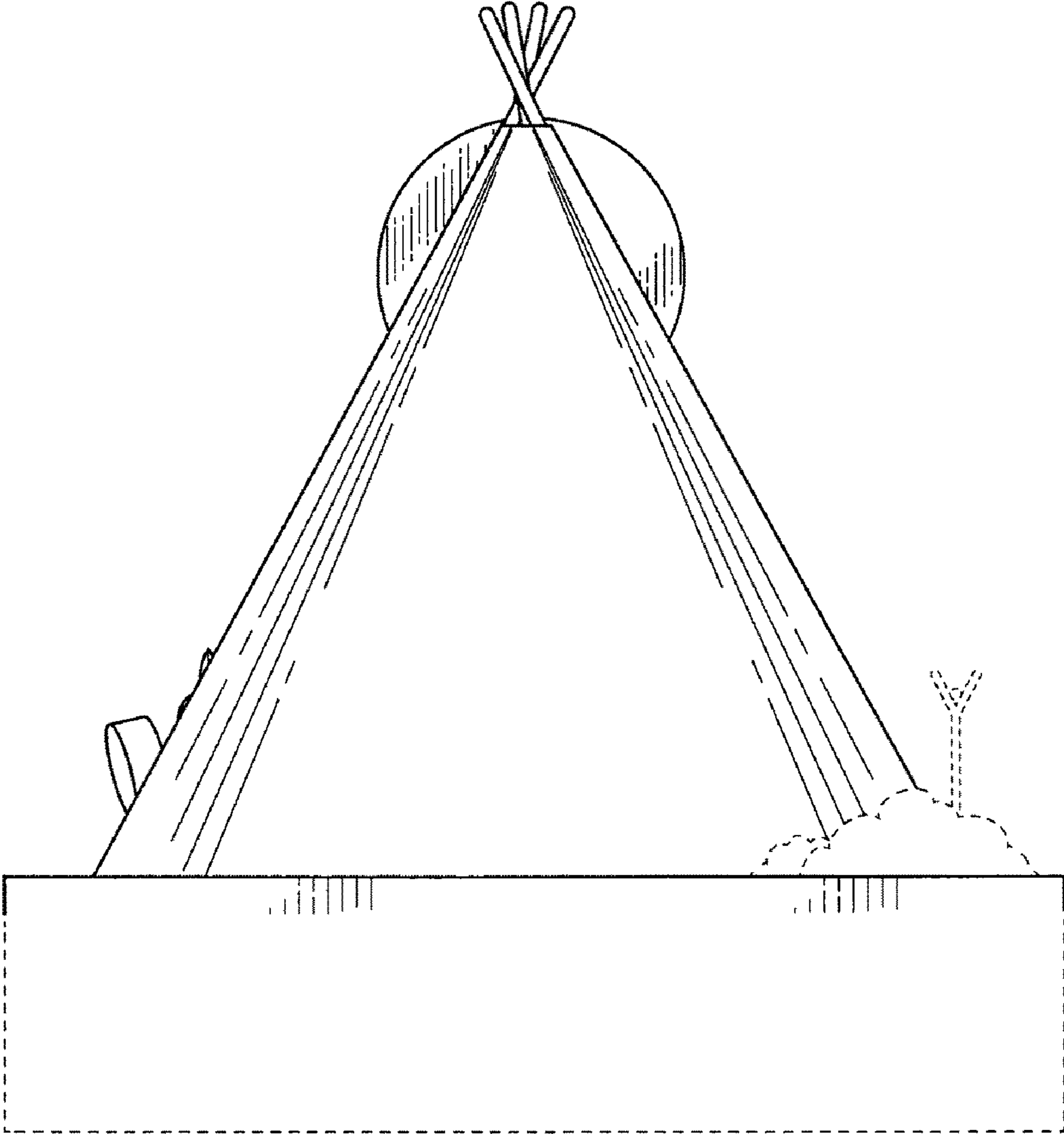

FIG. 7