



US00D671828S

(12) **United States Design Patent**
Williams

(10) **Patent No.:** **US D671,828 S**
(45) **Date of Patent:** **** Dec. 4, 2012**

(54) **GUN CLEANING TOOL PACKAGING KIT**

(75) Inventor: **Nicholas Williams**, Turin, NY (US)

(73) Assignee: **The Otis Patent Trust**, Lyons Falls, NY (US)

(**) Term: **14 Years**

(21) Appl. No.: **29/377,330**

(22) Filed: **Oct. 20, 2010**

(51) **LOC (9) Cl.** **09-03**

(52) **U.S. Cl.** **D9/418; D9/414**

(58) **Field of Classification Search** D9/700, D9/715-722, 723-725, 501, 517, 414, 415, D9/418, 424, 425-432, 434-436, 444, 445, D9/455, 499, 302, 901, 905; D3/11, 20, D3/200-206, 254, 257, 262, 263, 273, 274, D3/302, 901, 904, 905; D4/116; D18/14, D18/15, 18; D19/35, 54, 57, 66, 70, 71, D19/75, 81, 84; D22/108, 199; D28/7, 25, D28/38, 44, 61, 62, 66, 73-78, 83, 85; D32/35, D32/40, 42; D24/223; D7/601, 602, 629, D7/630, 635-641; D11/121, 122, 130, 131, D11/143-145, 155, 157-164; D30/101-107; D20/10, 12, 16, 19, 41, 99; D26/95, 110; 206/349-383, 461-471, 775-783, 235, 581, 206/385, 806, 822, 823; 220/229, 281, 288, 220/293-303, 323, 377, 602, 608, 623, 625, 220/630, 635, 636, 662, 665, 669, 675; 42/95
See application file for complete search history.

(56) **References Cited**

U.S. PATENT DOCUMENTS

47,260 A * 4/1865 Pratt 15/104.18
D101,378 S * 9/1936 Mayerhofer D11/164
2,530,024 A * 11/1950 Moody 206/375

D255,092 S * 5/1980 Wong D9/517
4,211,750 A * 7/1980 Gillespie 422/123
4,214,657 A * 7/1980 Winston 206/209.1
4,445,611 A * 5/1984 Shofu 206/369
D274,752 S * 7/1984 Byrne D24/223
D275,789 S * 10/1984 Byrne D24/223
D309,075 S * 7/1990 Rossari D7/635
D319,578 S * 9/1991 Chen D3/300
D383,225 S * 9/1997 Wolfard et al. D26/23
7,370,383 B1 * 5/2008 Chinowsky Wink 15/164
D602,663 S * 10/2009 Pennington D32/35
7,740,136 B2 * 6/2010 Roesler 206/379
D659,397 S * 5/2012 Deguglimo et al. D3/302

* cited by examiner

Primary Examiner — Catherine Tuttle

(74) *Attorney, Agent, or Firm* — Harris Beach PLLC

(57) **CLAIM**

The ornamental design for a gun cleaning tool packaging kit, as shown and described.

DESCRIPTION

FIG. 1 is a perspective view showing my new design for a gun cleaning tool packaging kit;
FIG. 2 is a right side elevation view thereof, the left side elevation view being identical thereto;
FIG. 3 is a top plan view;
FIG. 4 is a front elevation view thereof;
FIG. 5 is a perspective view showing a second embodiment of my new design for a gun cleaning tool packaging kit;
FIG. 6 is a right side elevation view thereof, the left side elevation view being identical thereto;
FIG. 7 is a top plan view; and,
FIG. 8 is a front elevation view thereof.
In FIGS. 1-8, the broken lines showing a gun cleaning brush situated in the packaging kit are for illustrative purposes only and forms no part of the claimed design.

1 Claim, 2 Drawing Sheets

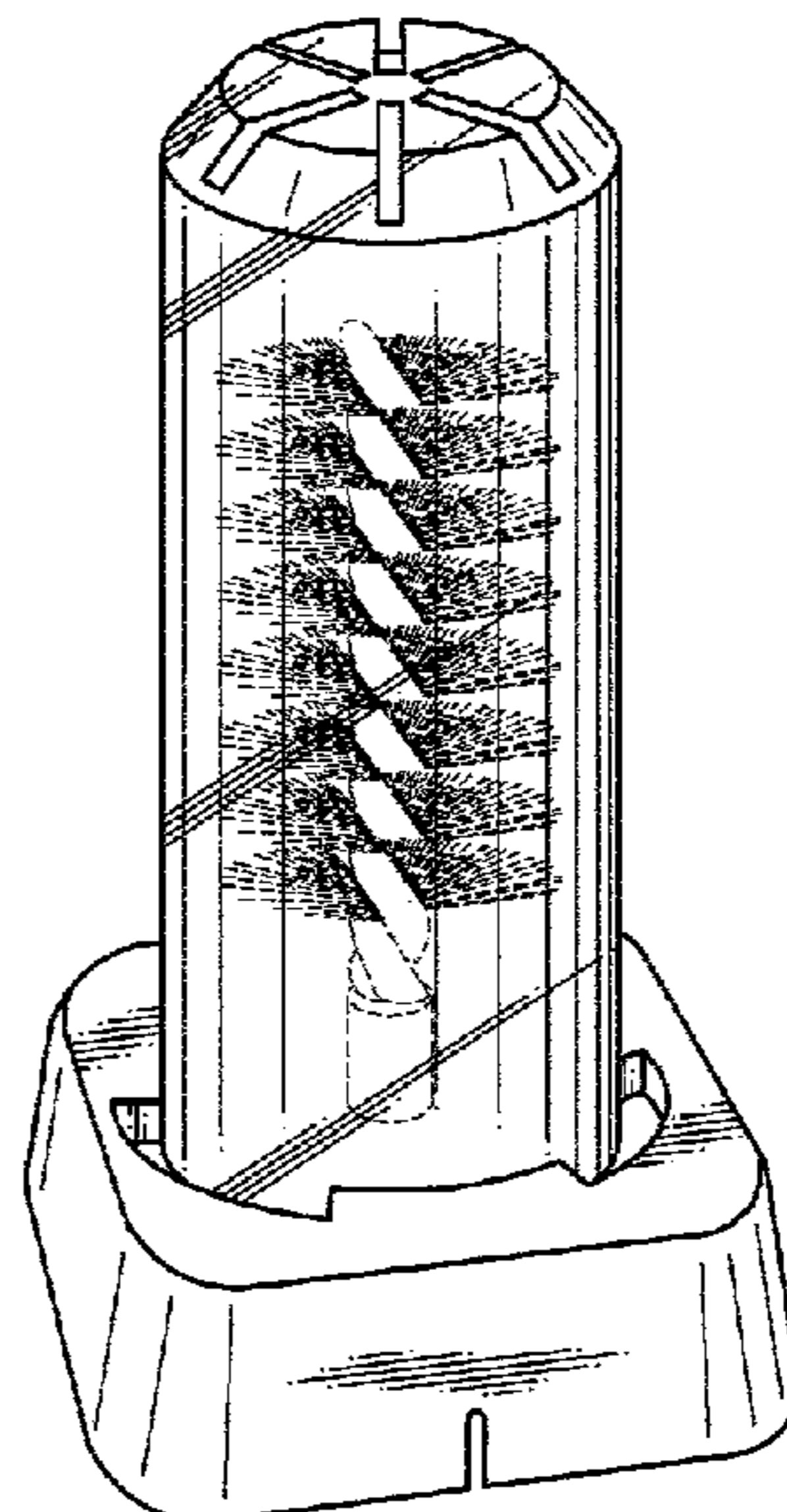
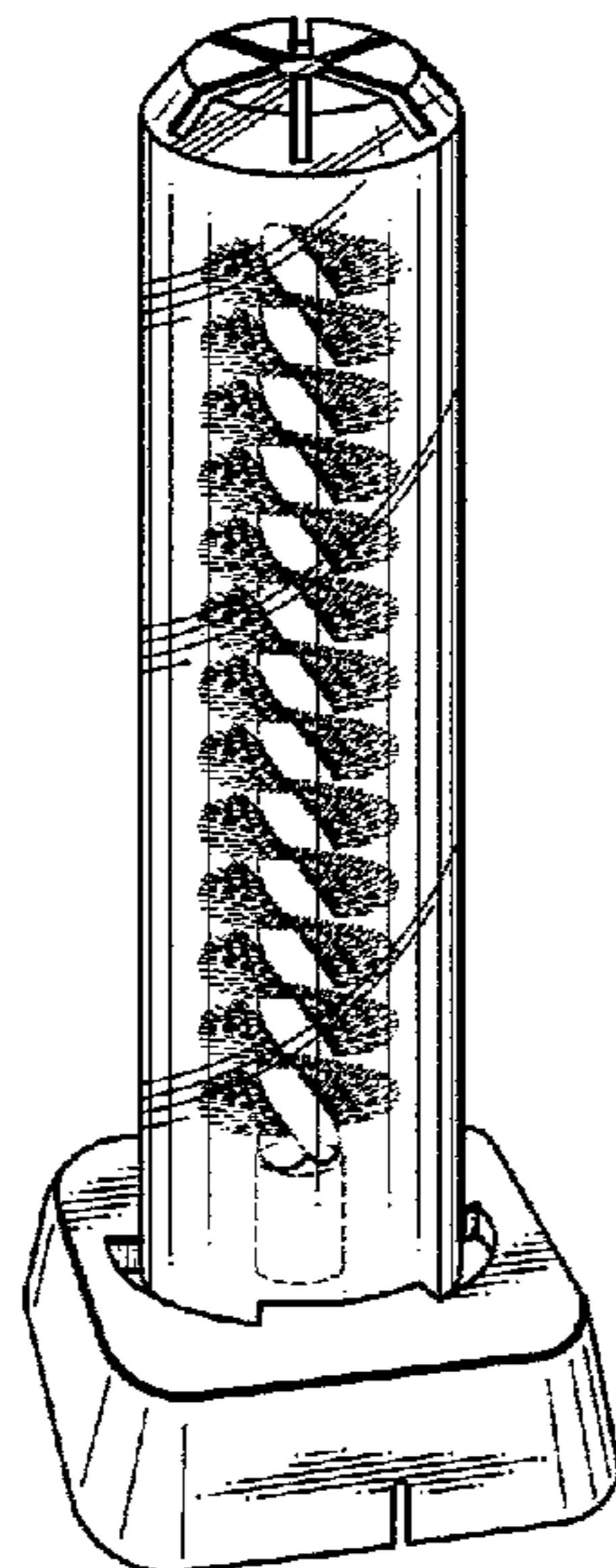

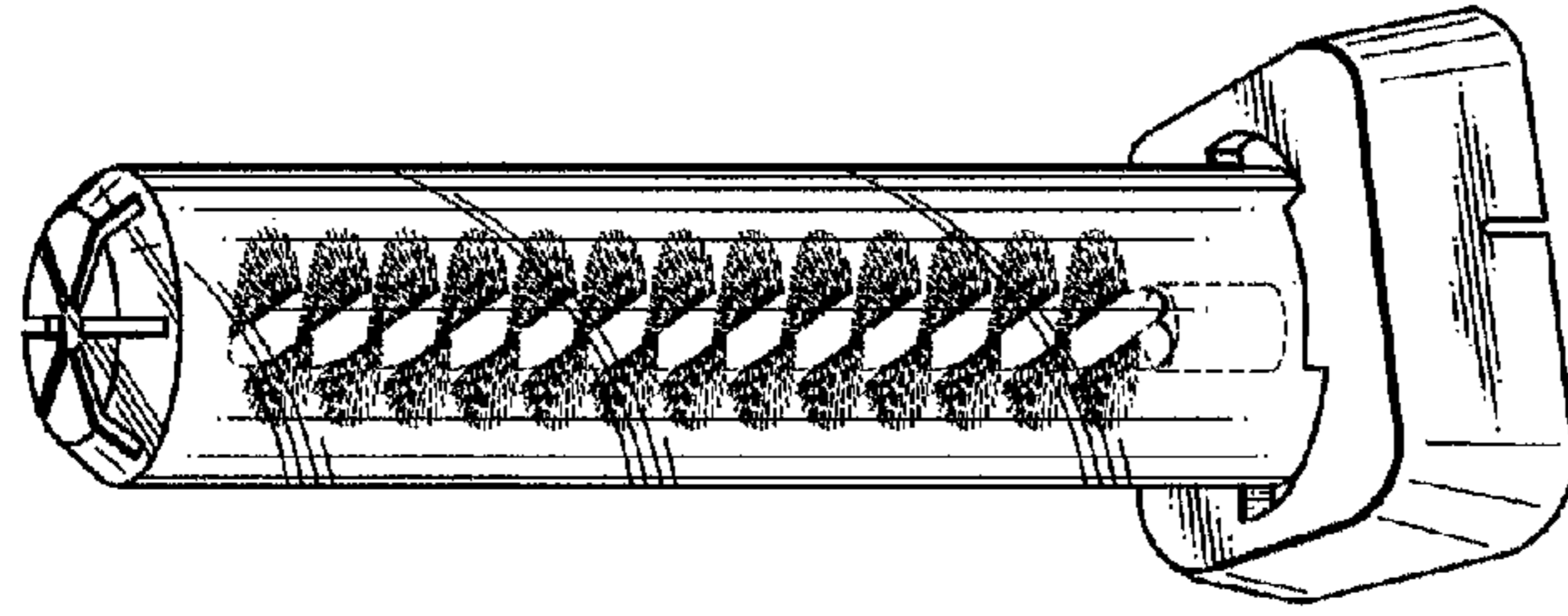

FIG. 1

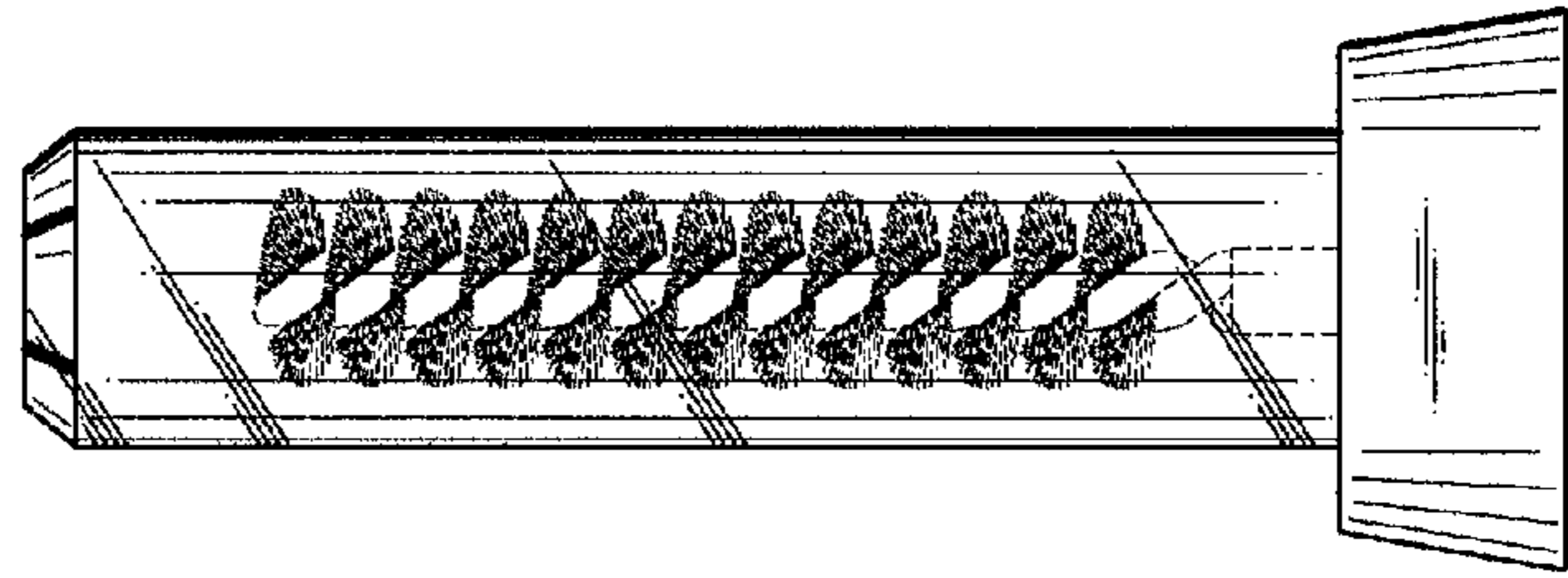

FIG. 4

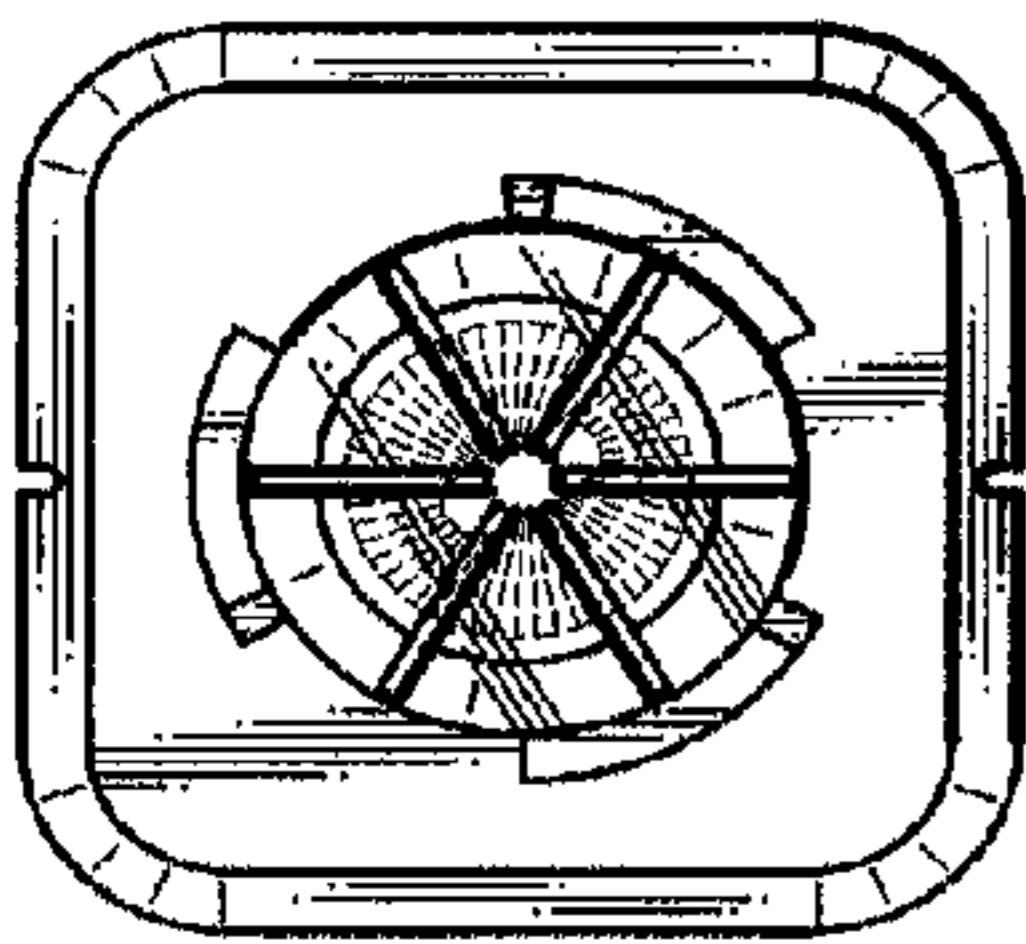

FIG. 3

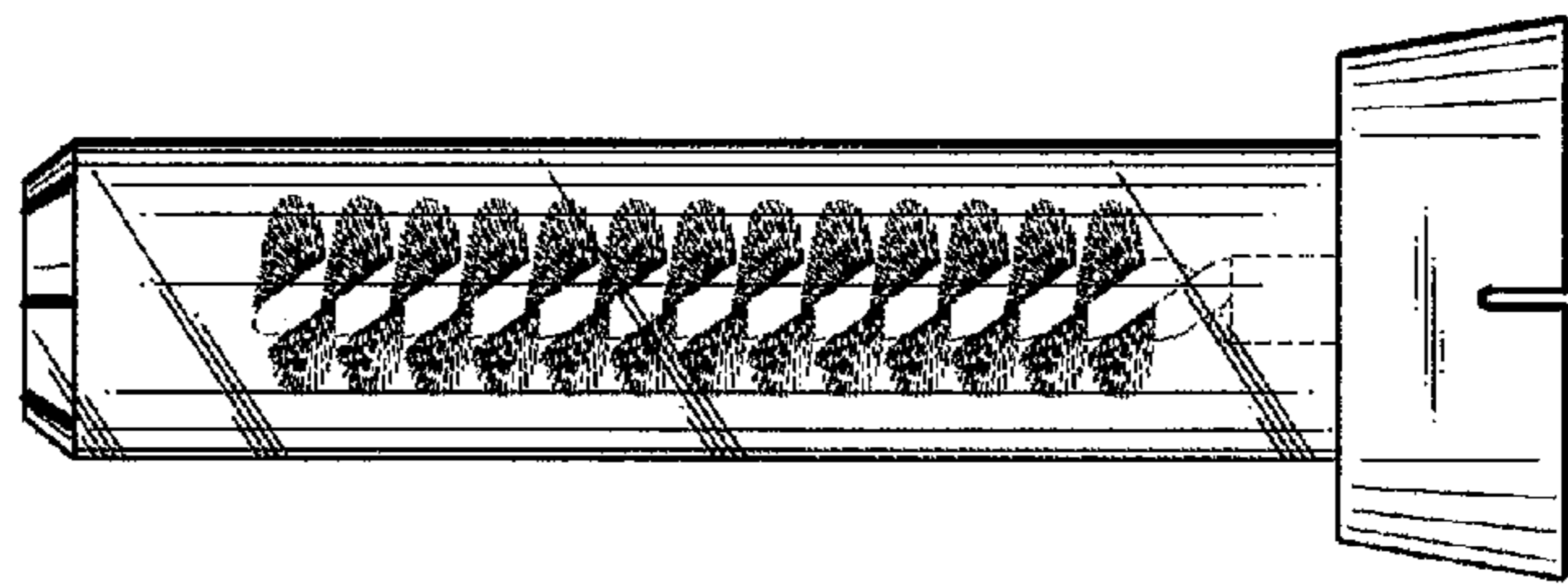

FIG. 2

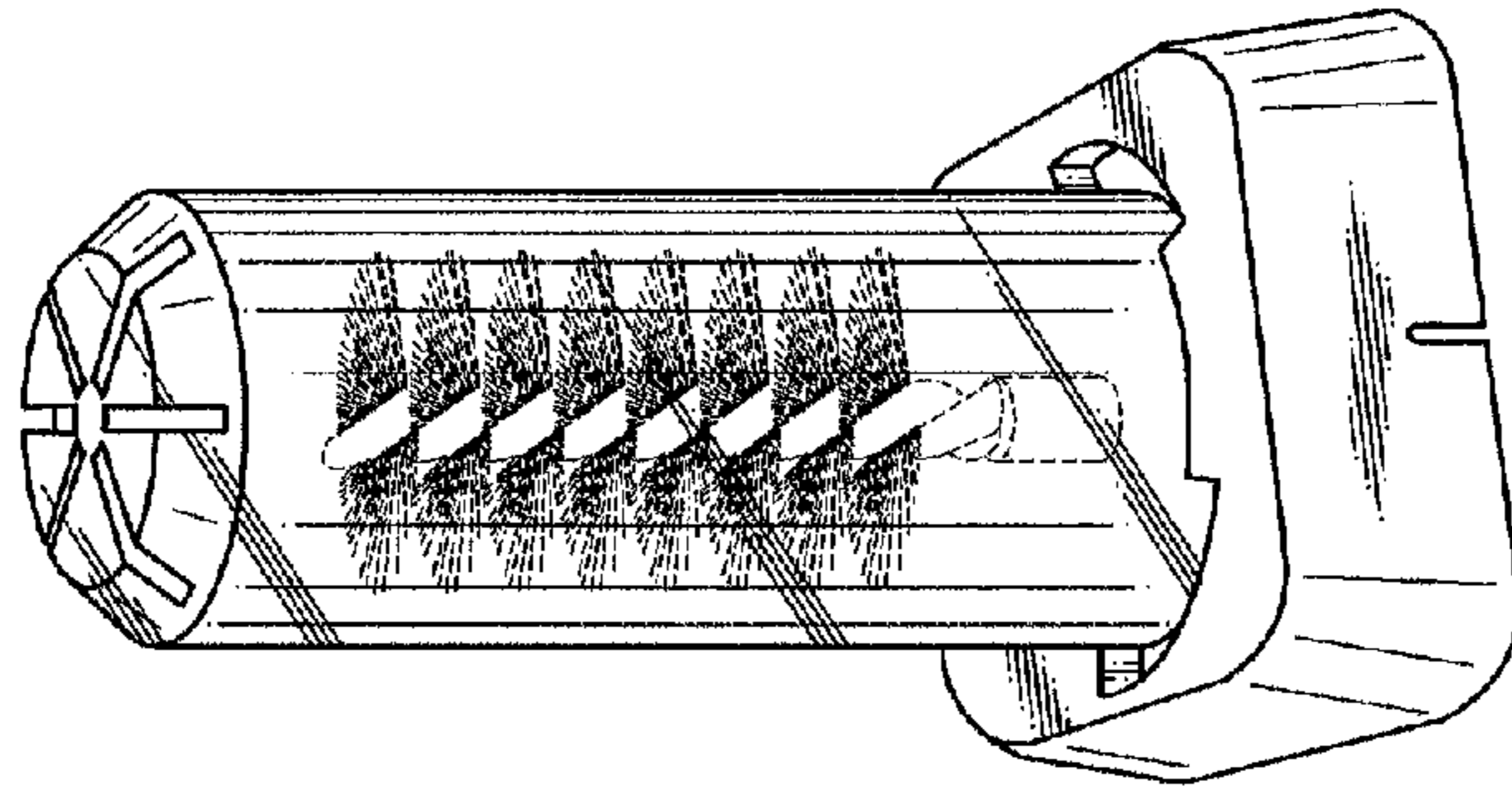

FIG. 5

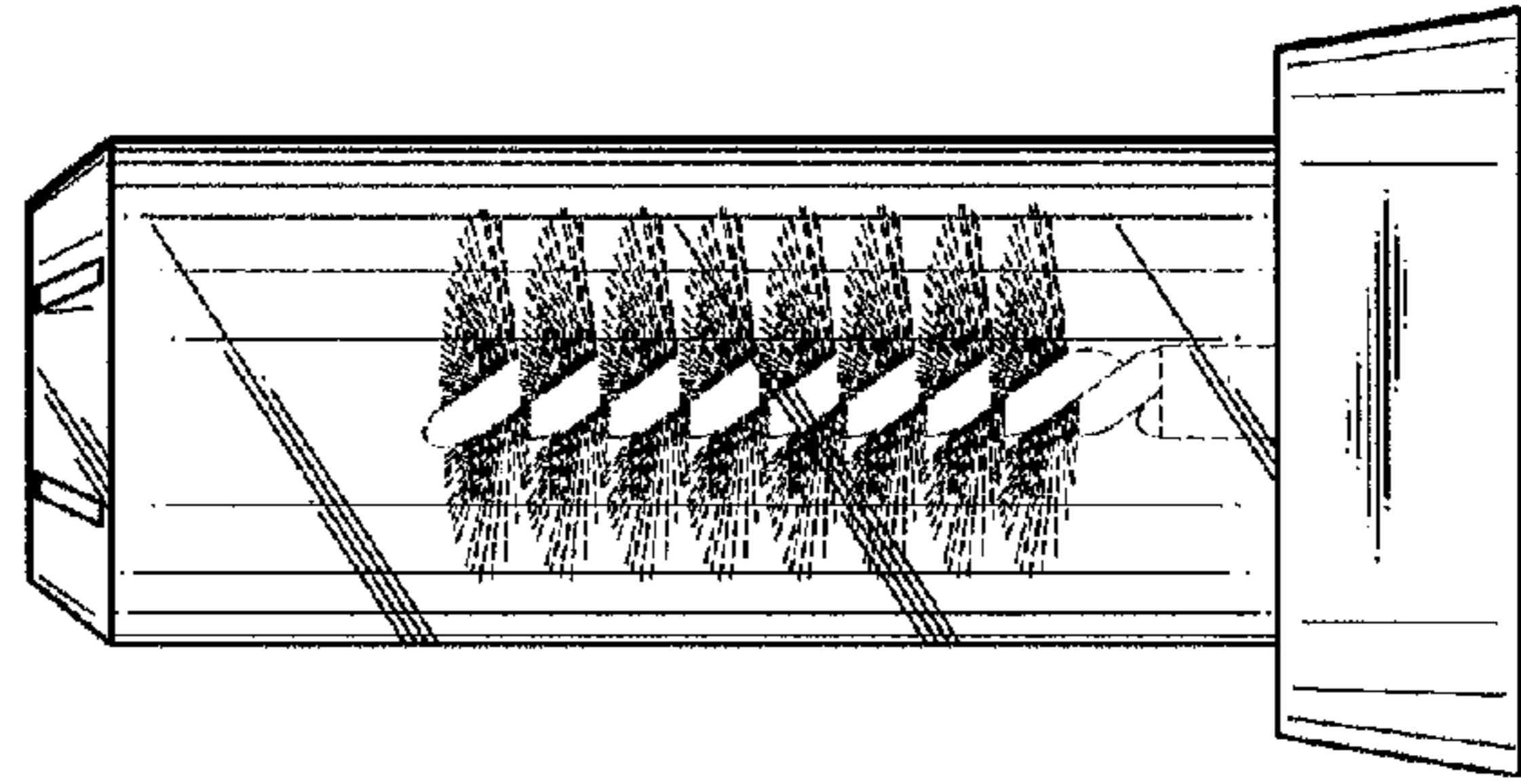

FIG. 8

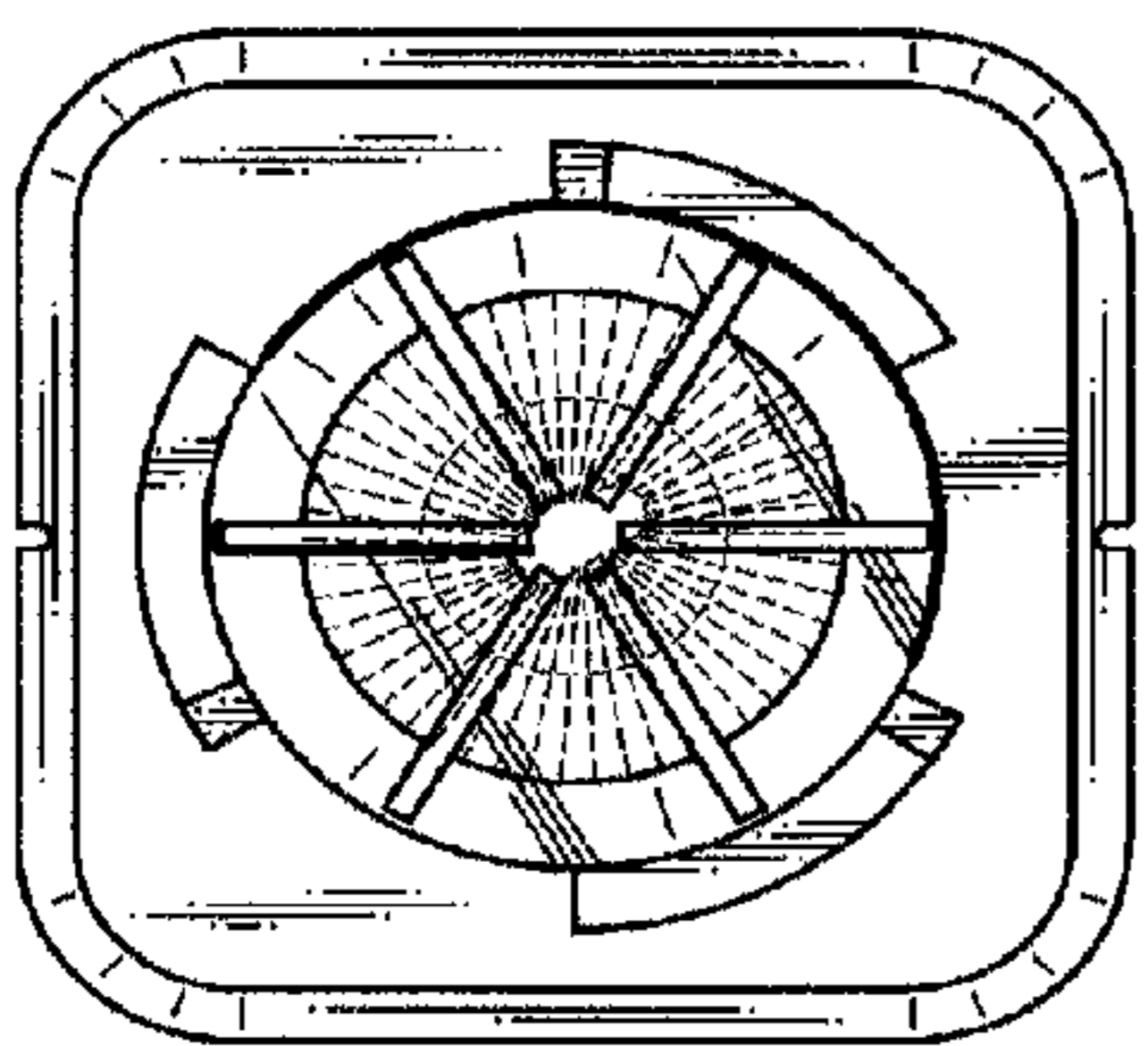

FIG. 7

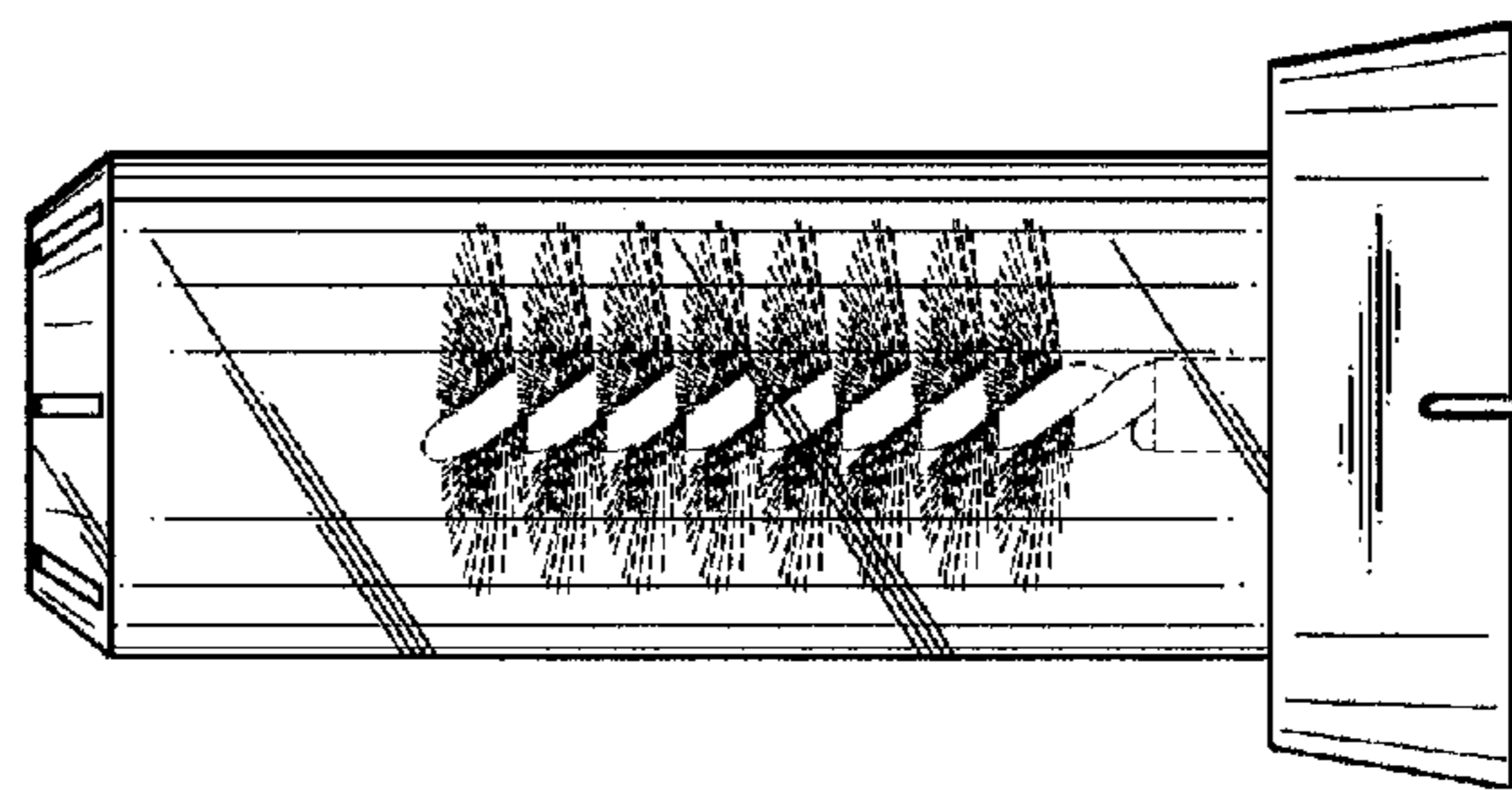

FIG. 6