



US00D671824S

(12) **United States Design Patent**
van der Lande

(10) **Patent No.:** **US D671,824 S**

(45) **Date of Patent:** **** Dec. 4, 2012**

(54) **PIG SHAPED BAG CLIP**

(75) Inventor: **Jan van der Lande**, New York, NY (US)

(73) Assignee: **Kikkerland Design Inc.**, New York, NY (US)

(**) Term: **14 Years**

(21) Appl. No.: **29/402,795**

(22) Filed: **Sep. 27, 2011**

(51) **LOC (9) Cl.** **08-08**

(52) **U.S. Cl.** **D8/395**

(58) **Field of Classification Search** D8/394-396,
D8/72, 367, 373; D19/56, 65, 86; 24/67.3;
D32/60-64; D28/40

See application file for complete search history.

(56) **References Cited**

U.S. PATENT DOCUMENTS

462,358	A	*	11/1891	Knowles	24/511
D85,796	S	*	12/1931	Wells	D7/685
D137,693	S	*	4/1944	Reinecke	D21/592
D175,981	S	*	11/1955	Rubeck	D11/78.1
D262,802	S	*	1/1982	Ylvisaker et al.	D20/42
D315,735	S	*	3/1991	Chu	D14/189
5,642,556	A	*	7/1997	Alexander	24/163 K
D406,168	S	*	2/1999	Wolff	D19/65

D406,170	S	*	2/1999	Wolff	D19/65
D493,487	S	*	7/2004	Nuttall et al.	D19/65
D505,635	S	*	5/2005	McGee	D11/78.1
D529,375	S	*	10/2006	Cetera	D8/395
D531,675	S	*	11/2006	Cetera	D19/91
D549,529	S	*	8/2007	Risch et al.	D7/685
D559,673	S	*	1/2008	Dash	D8/395
D598,279	S	*	8/2009	Seehoff et al.	D8/395
D650,951	S	*	12/2011	Connelly et al.	D30/136

* cited by examiner

Primary Examiner — John Windmuller

(74) *Attorney, Agent, or Firm* — Cascio & Zervas

(57) **CLAIM**

The ornamental design for a pig shaped bag clip, as shown and described.

DESCRIPTION

FIG. 1 is a front elevational view of the pig shaped bag clip showing my design;

FIG. 2 is a rear elevational view thereof;

FIG. 3 is a left side elevational view thereof;

FIG. 4 is a right side elevational view thereof;

FIG. 5 is a top plan view thereof;

FIG. 6 is a bottom plan view thereof; and,

FIG. 7 is a front perspective view thereof.

1 Claim, 3 Drawing Sheets

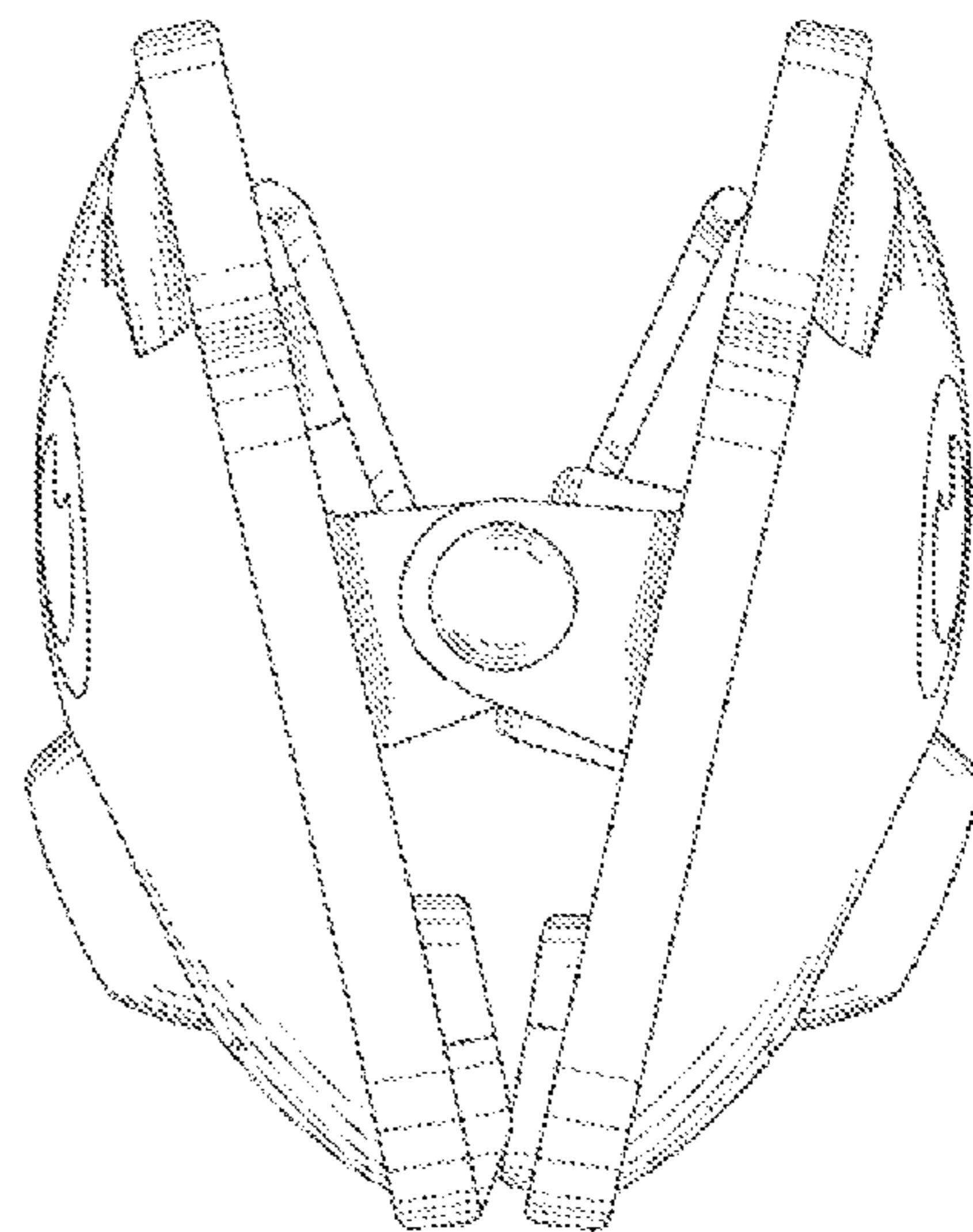
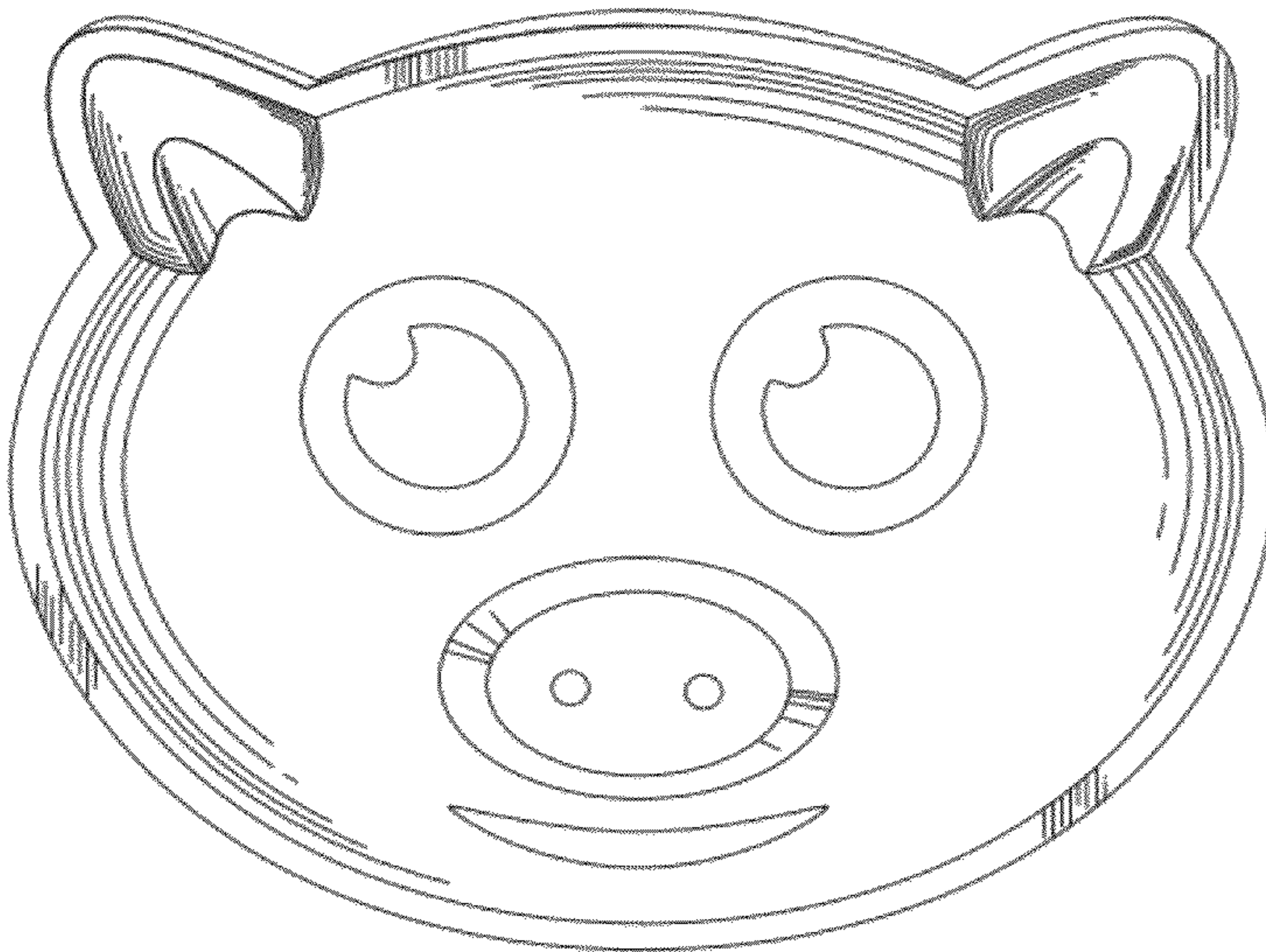

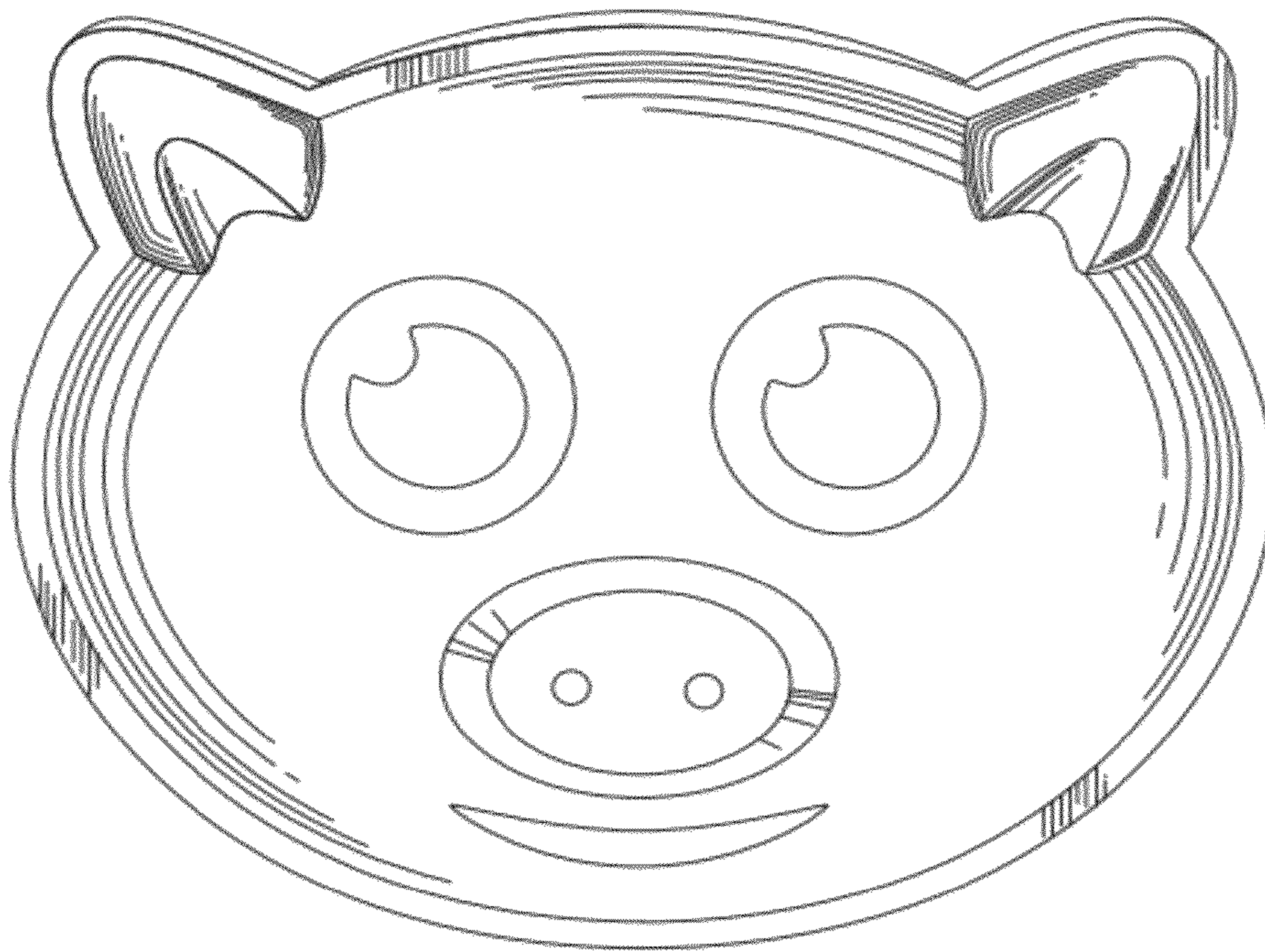

FIG. 1

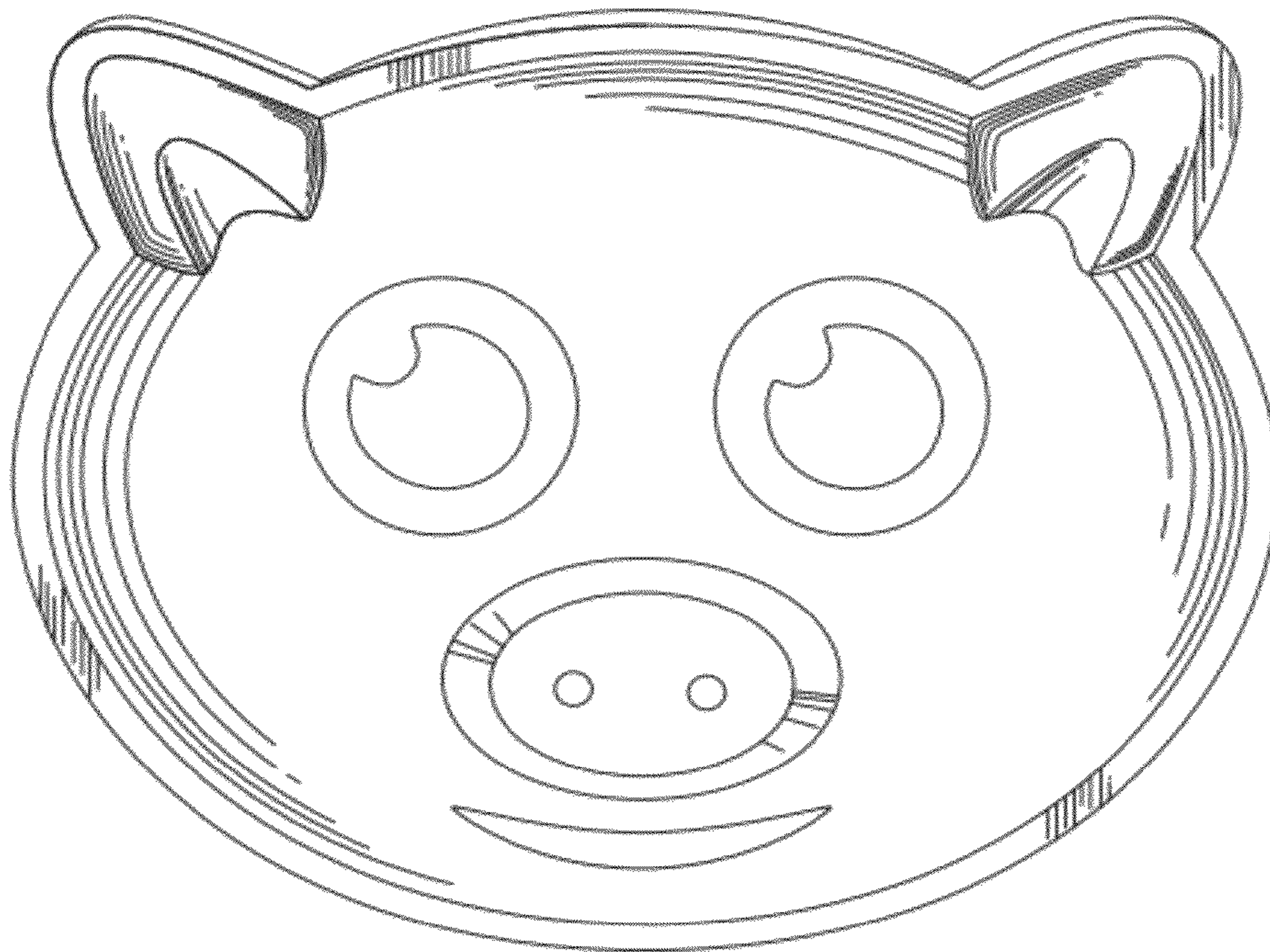

FIG. 2

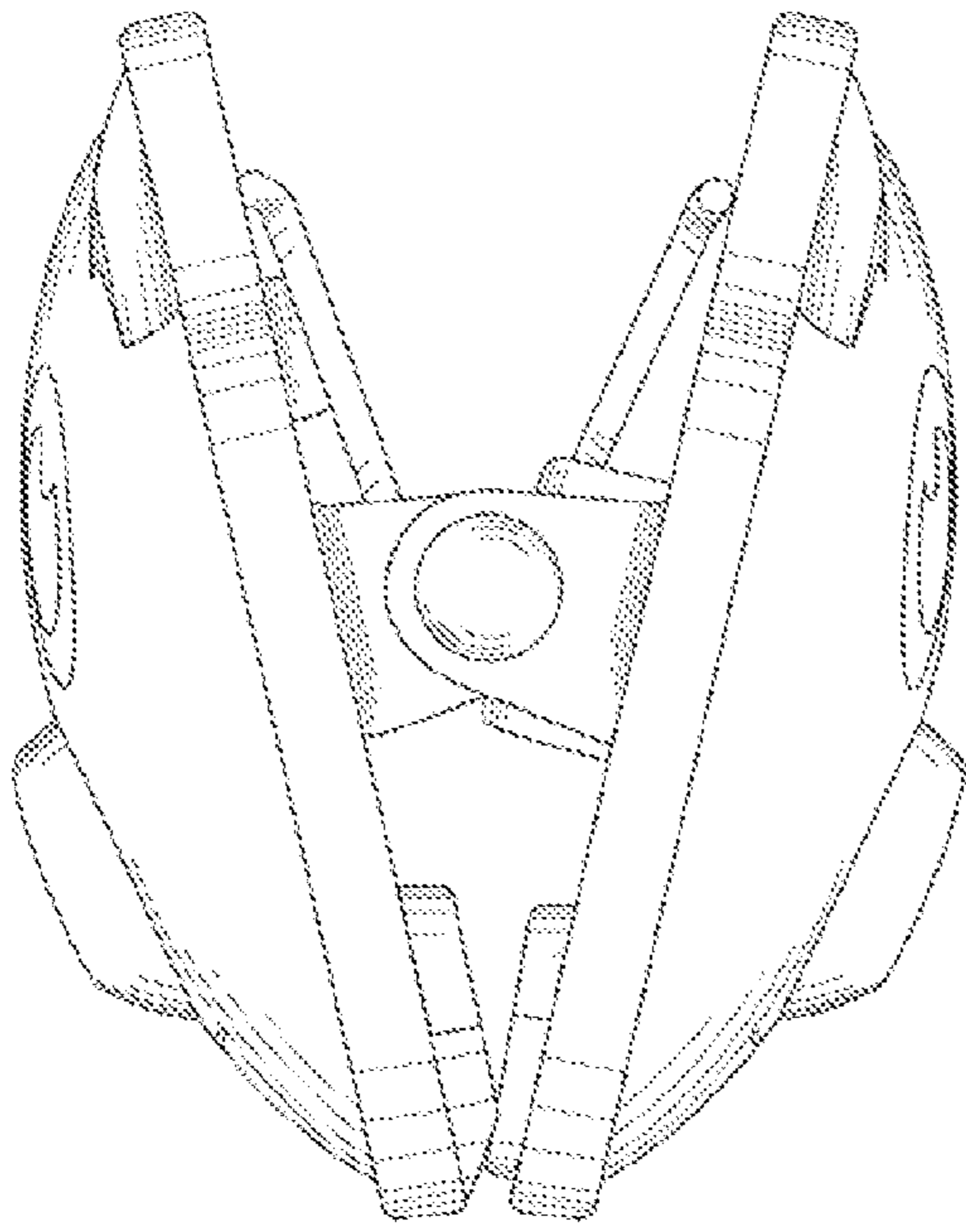

FIG. 3

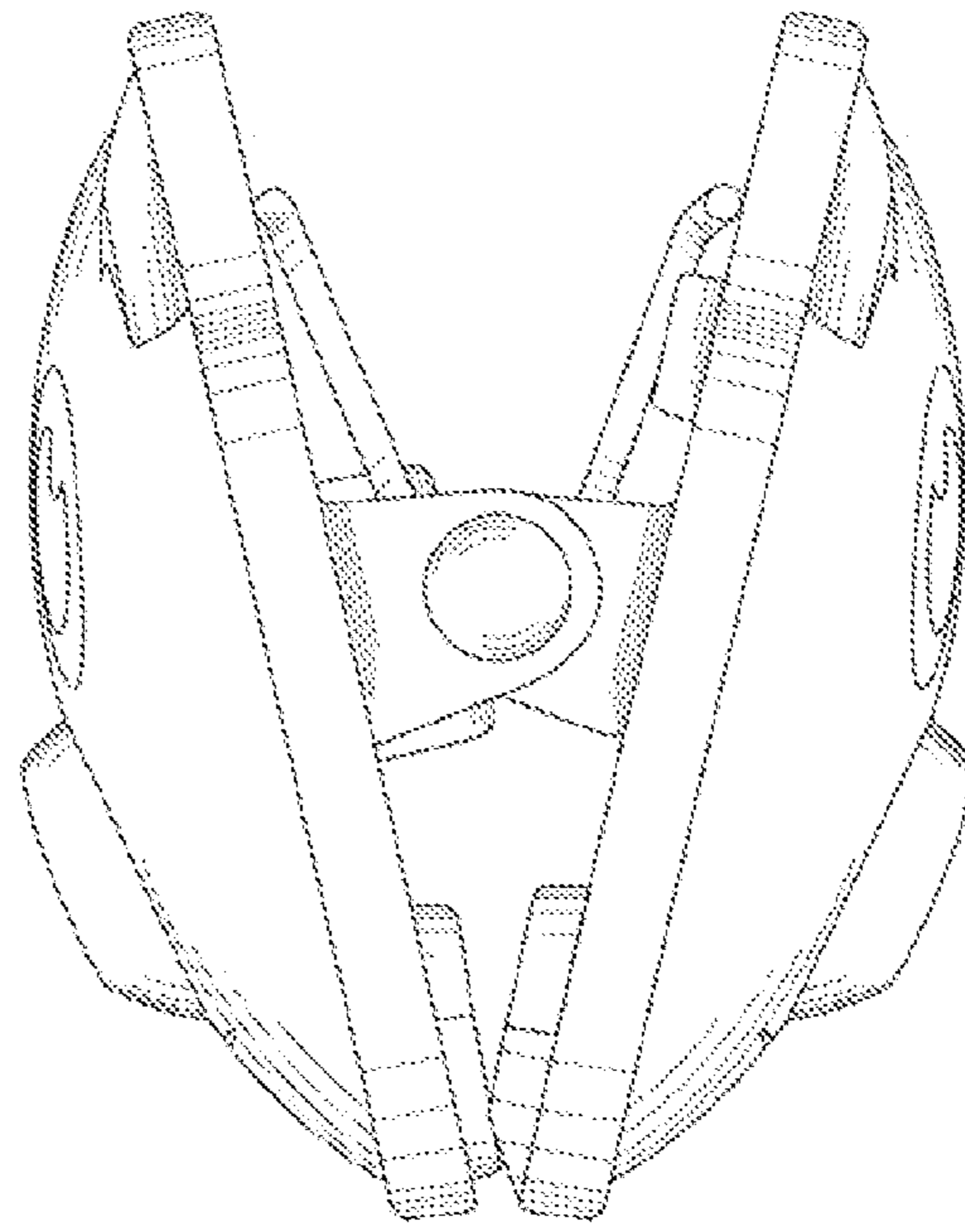

FIG. 4

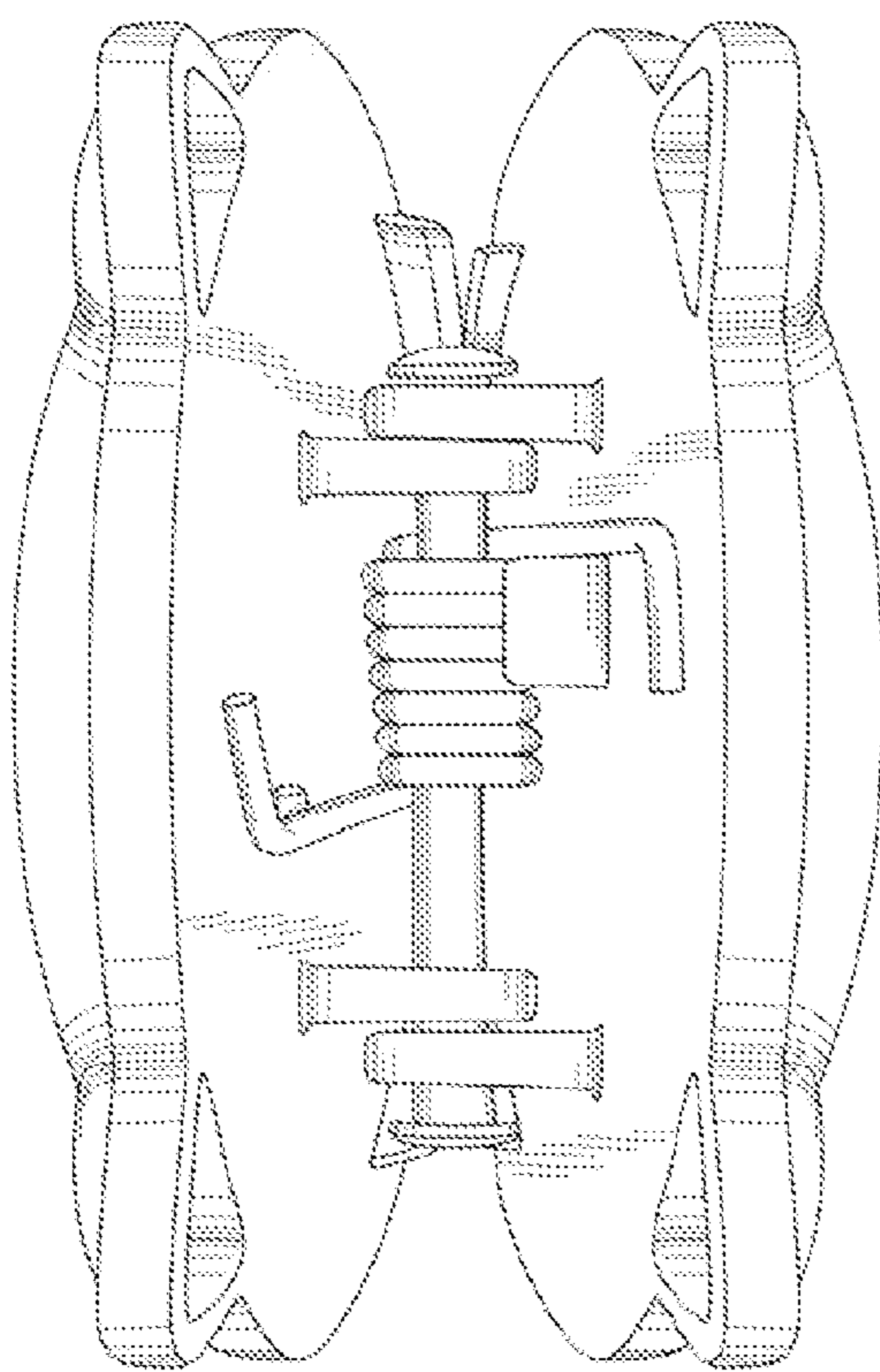

FIG. 5

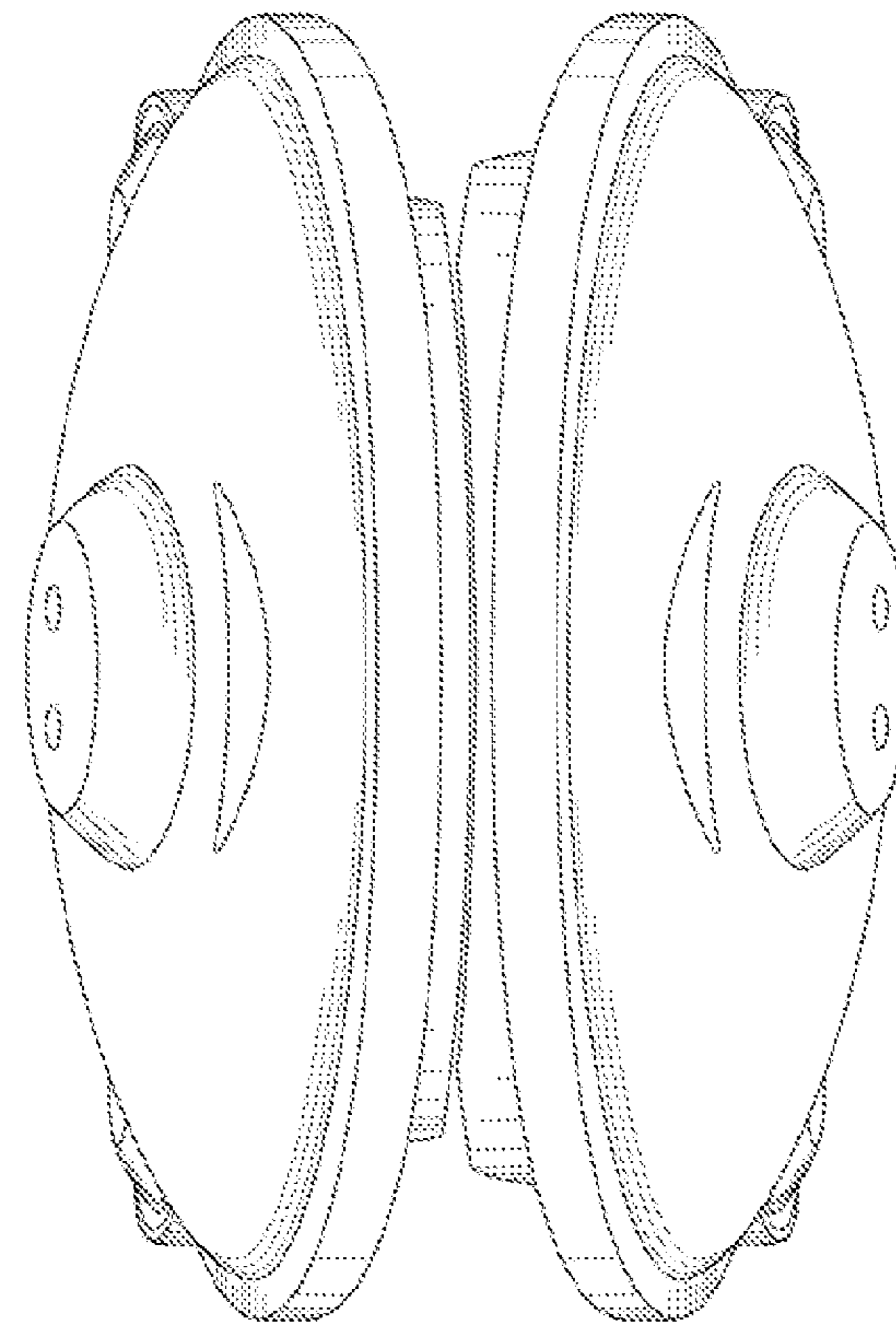

FIG. 6

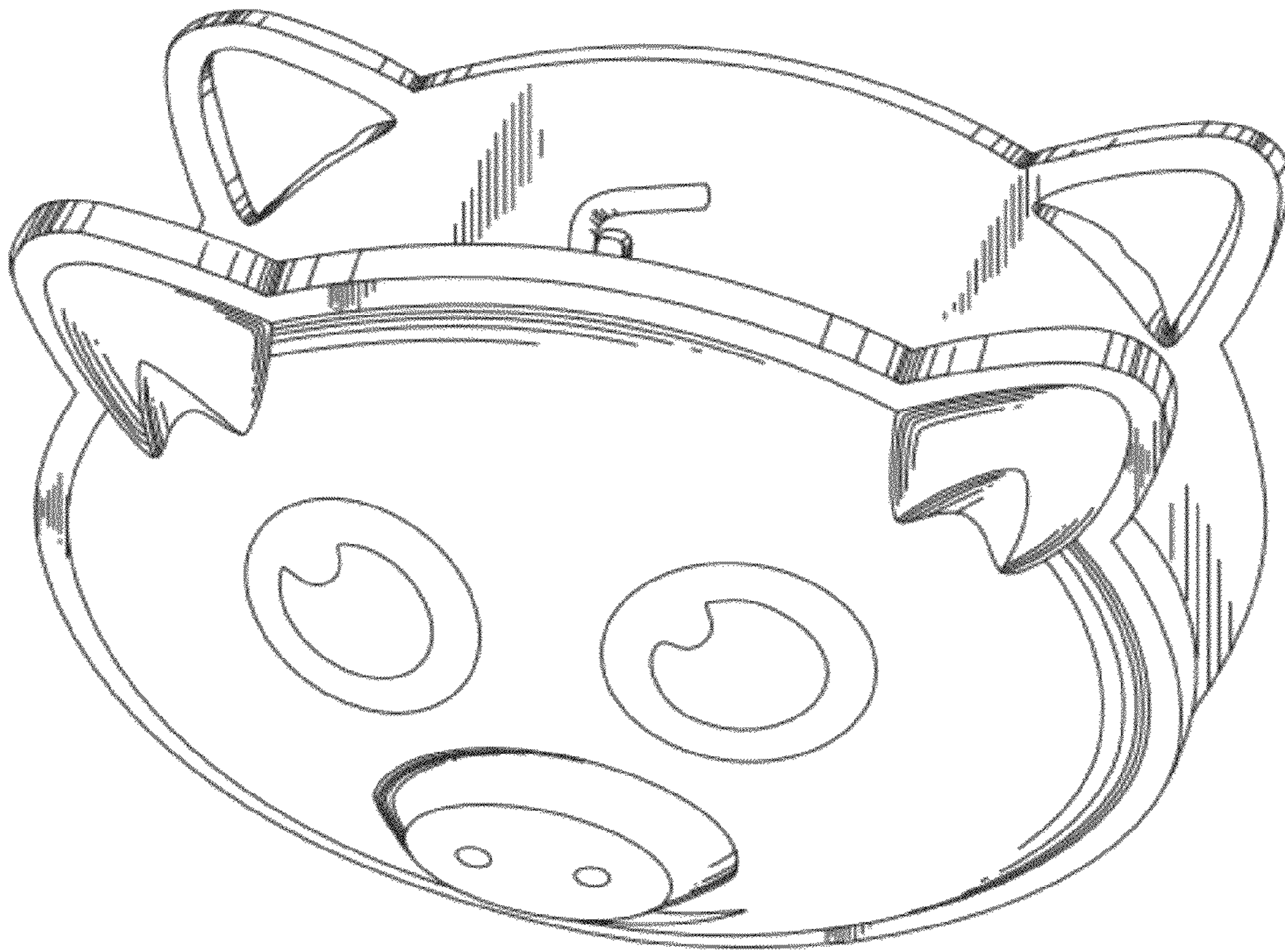

FIG. 7