



US00D671823S

(12) **United States Design Patent**  
**van der Lande**

(10) **Patent No.:** **US D671,823 S**

(45) **Date of Patent:** **\*\* Dec. 4, 2012**

(54) **BIRD SHAPED BAG CLIP**

(75) Inventor: **Jan van der Lande**, New York, NY (US)

(73) Assignee: **Kikkerland Design Inc.**, New York, NY (US)

(\*\*) Term: **14 Years**

(21) Appl. No.: **29/402,789**

(22) Filed: **Sep. 27, 2011**

(51) **LOC (9) Cl.** ..... **08-08**

(52) **U.S. Cl.** ..... **D8/395**

(58) **Field of Classification Search** ..... D8/394-396,  
D8/72, 367, 373; D19/56, 65, 86; 24/67.3;  
D32/60-64; D28/40

See application file for complete search history.

(56) **References Cited**

**U.S. PATENT DOCUMENTS**

D85,796 S *	12/1931	Wells	.....	D7/685
D406,169 S *	2/1999	Wolff	.....	D19/65
D406,170 S *	2/1999	Wolff	.....	D19/65
D518,411 S *	4/2006	Weiser et al.	.....	D11/162
D529,375 S *	10/2006	Cetera	.....	D8/395
D549,529 S *	8/2007	Risch et al.	.....	D7/685

D554,450 S *	11/2007	Raia	.....	D7/695
D559,673 S *	1/2008	Dash	.....	D8/395
D564,346 S *	3/2008	Wolff et al.	.....	D8/395
D566,536 S *	4/2008	Wolff et al.	.....	D8/395
D598,279 S *	8/2009	Seehoff et al.	.....	D8/395
D613,187 S *	4/2010	Bialek-Wester	.....	D10/40

\* cited by examiner

*Primary Examiner* — John Windmuller

(74) *Attorney, Agent, or Firm* — Cascio & Zervas

(57) **CLAIM**

The ornamental design for a bird shaped bag clip, as shown and described.

**DESCRIPTION**

FIG. 1 is a front elevational view of the bird shaped bag clip showing my design;  
FIG. 2 is a rear elevational view thereof;  
FIG. 3 is a left side elevational view thereof;  
FIG. 4 is a right side elevational view thereof;  
FIG. 5 is a top plan view thereof;  
FIG. 6 is a bottom plan view thereof; and,  
FIG. 7 is a front perspective view thereof.

**1 Claim, 3 Drawing Sheets**

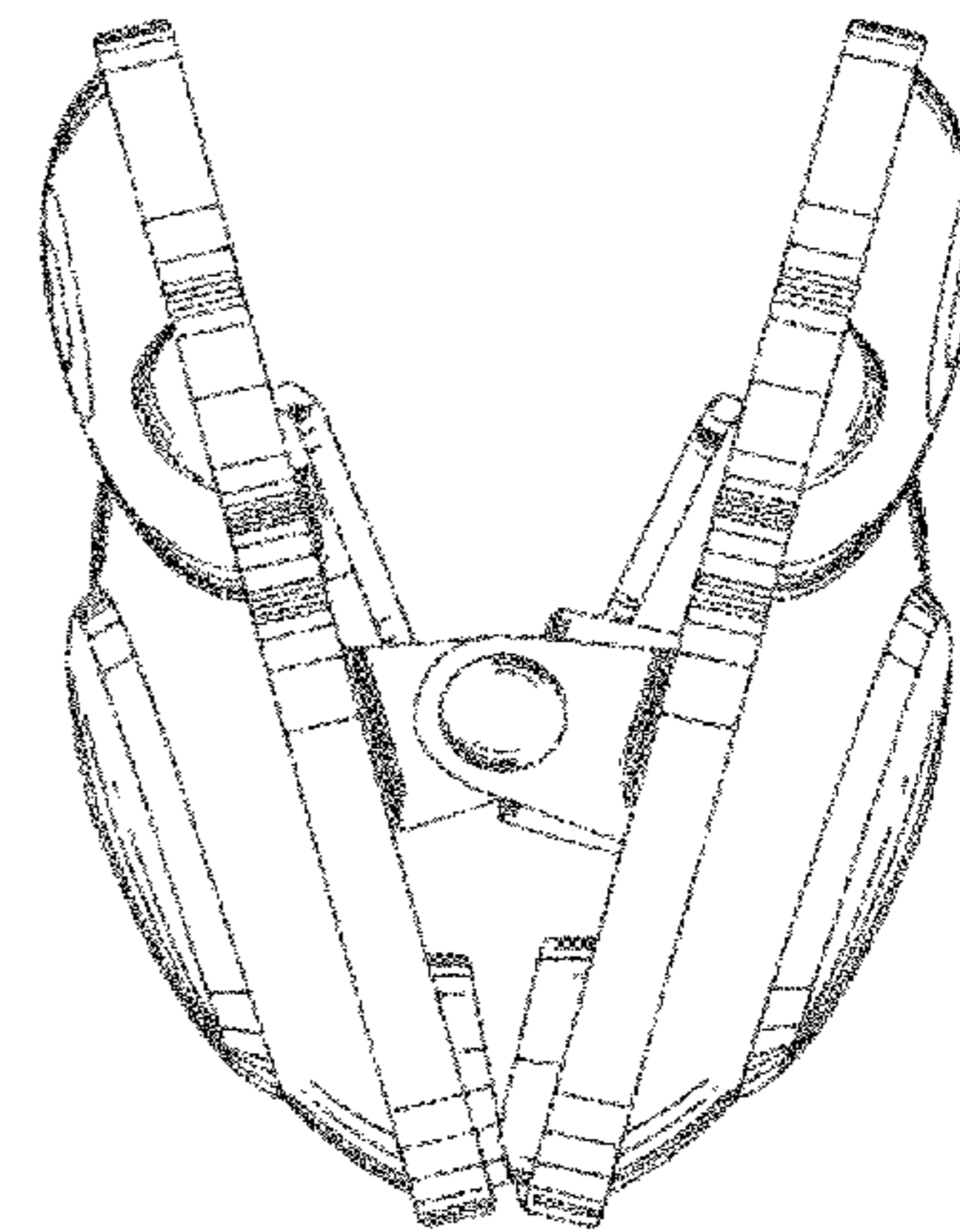
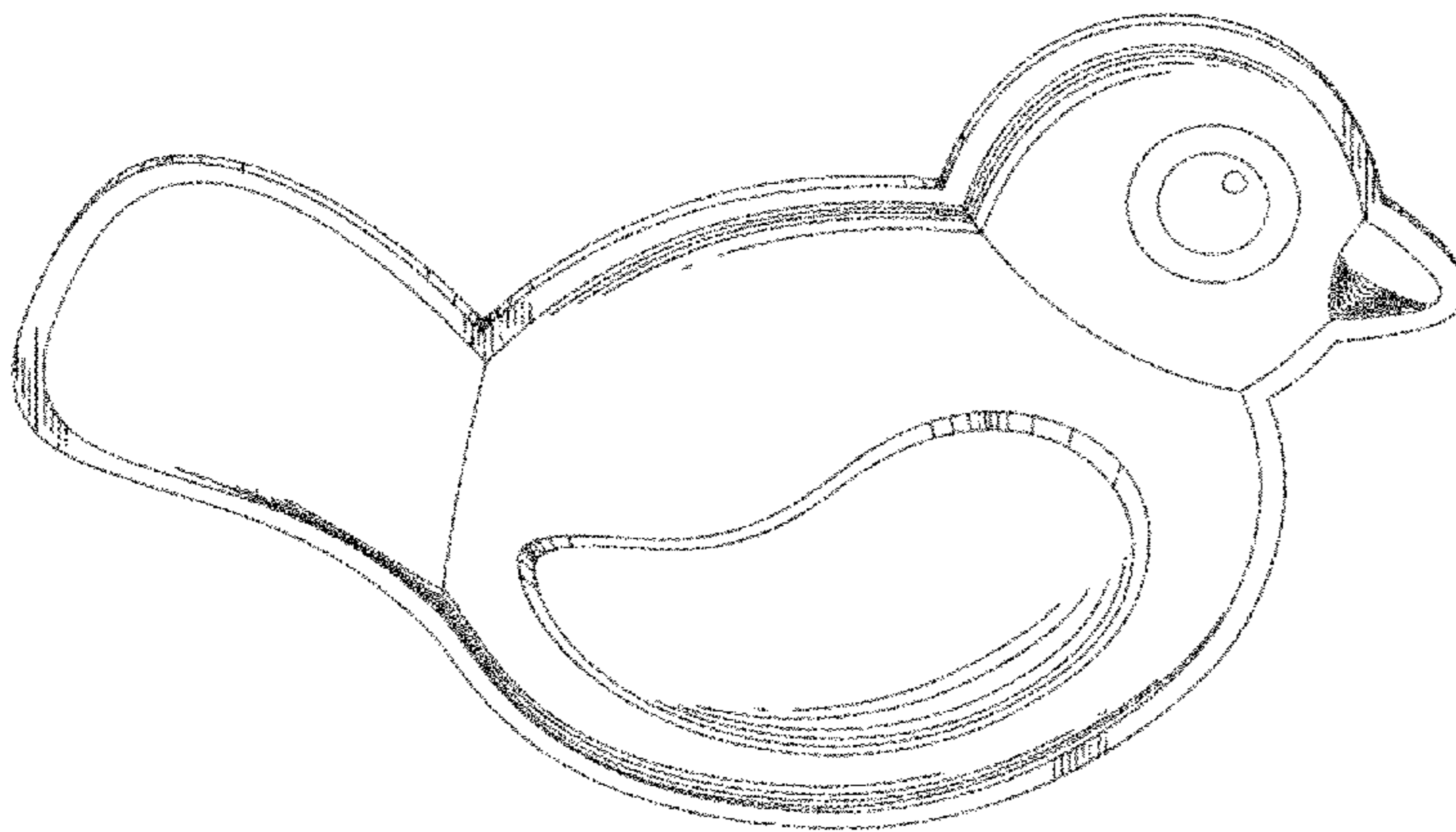

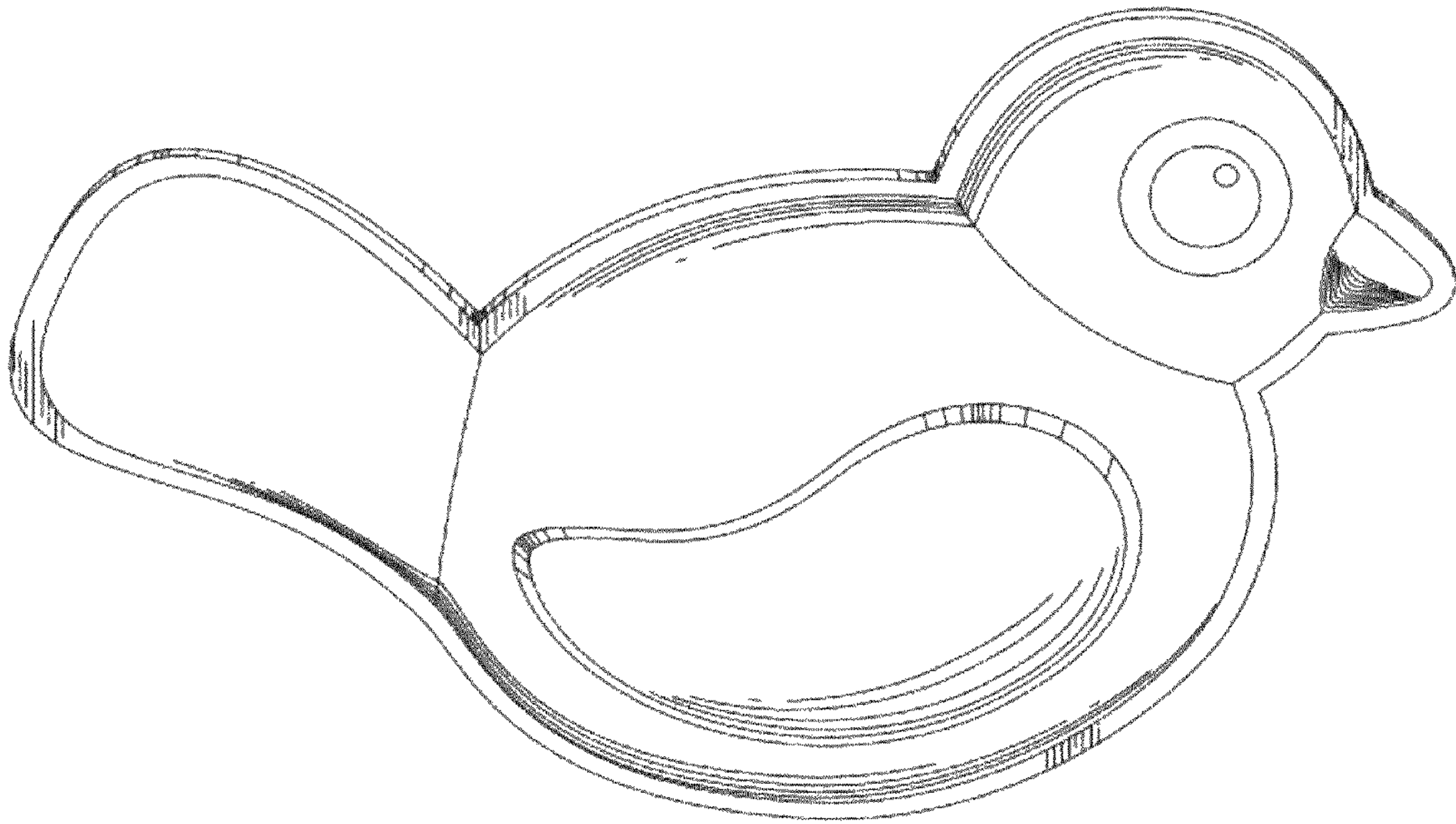

FIG. 1

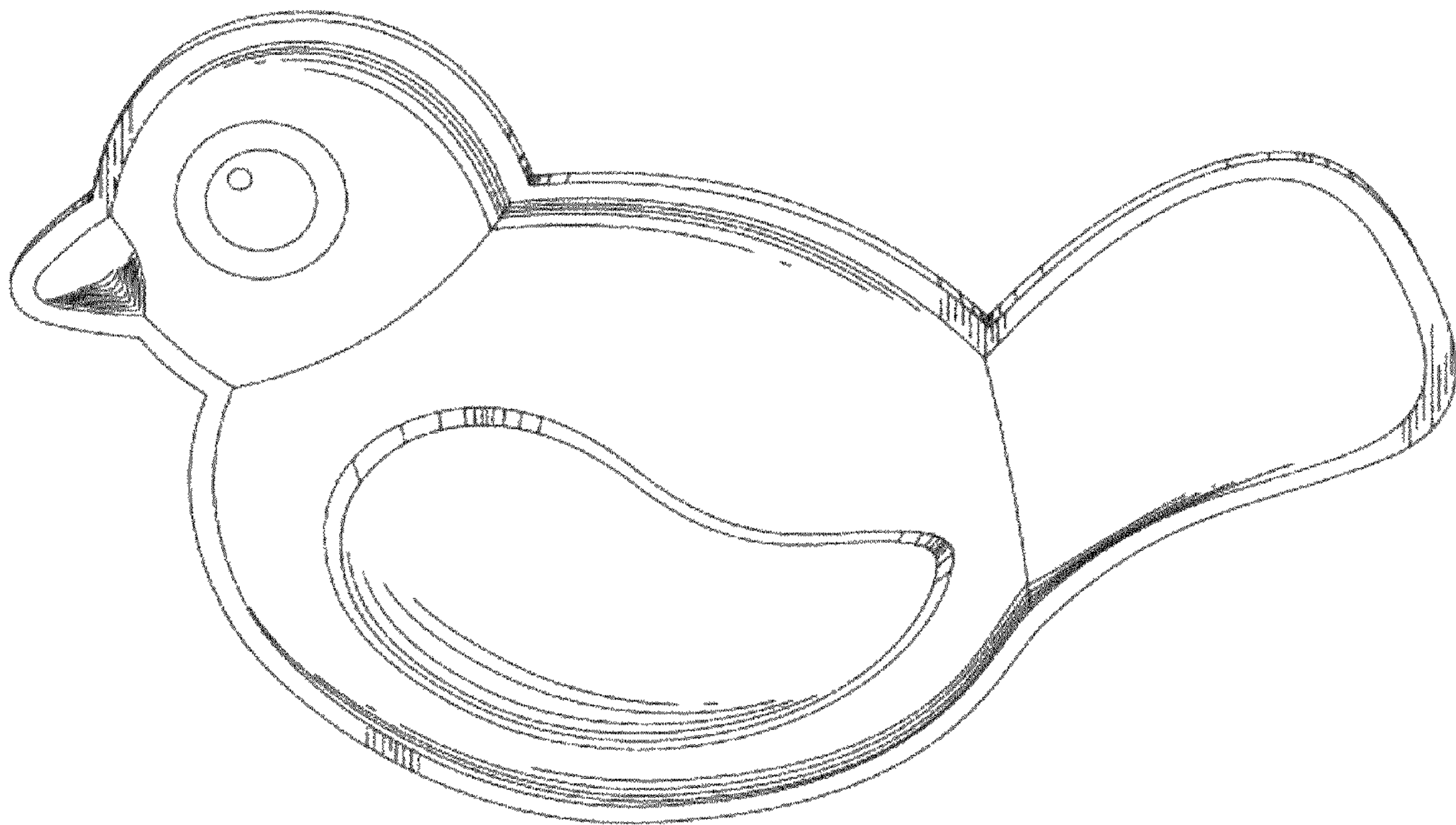

FIG. 2

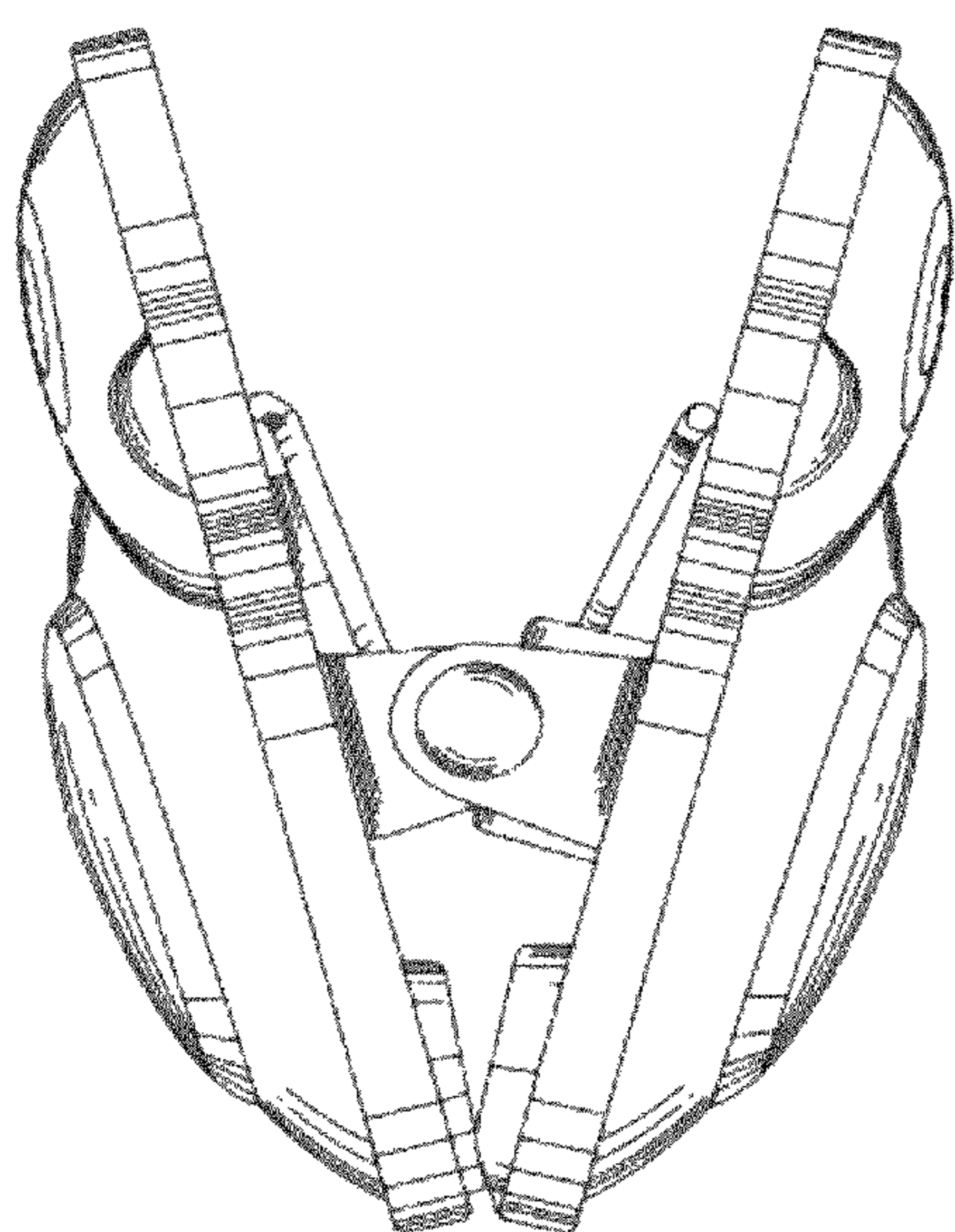

FIG. 3

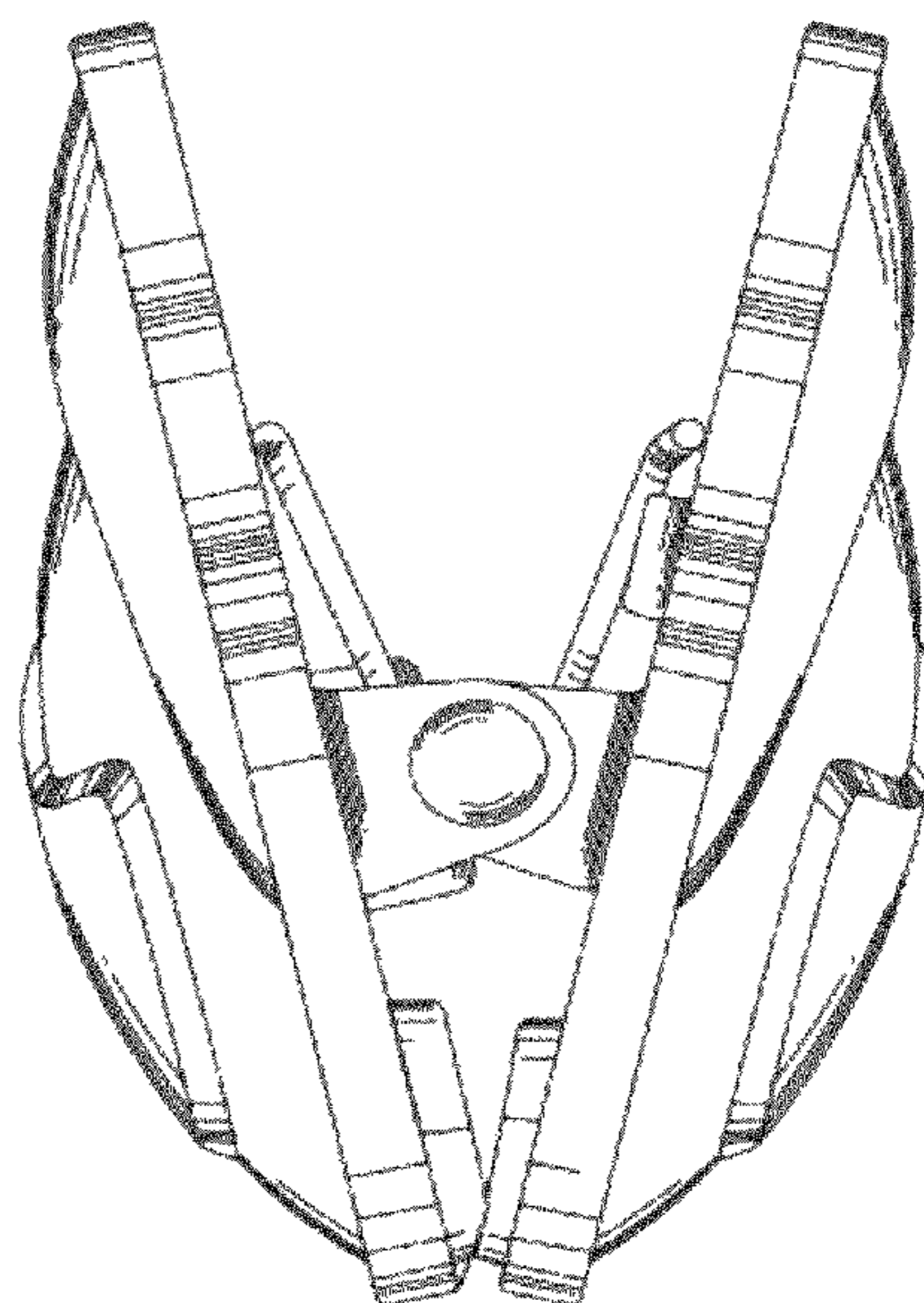

FIG. 4

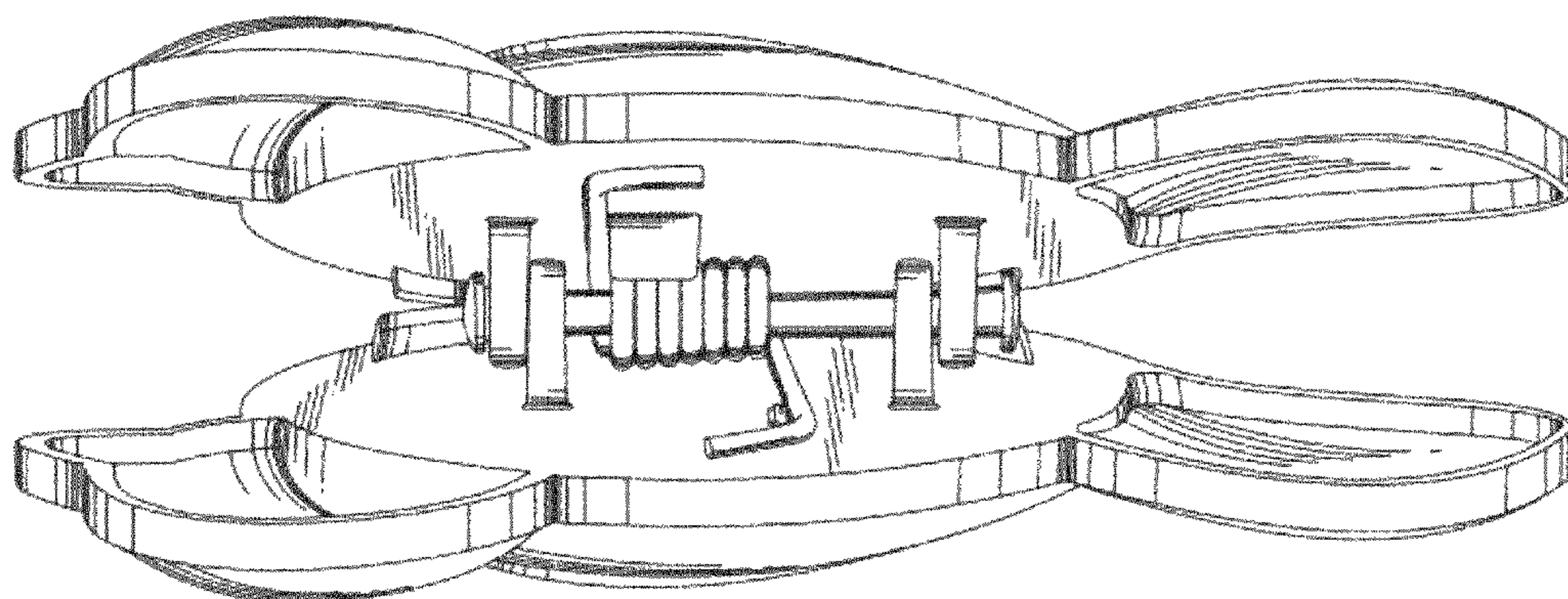

FIG. 5

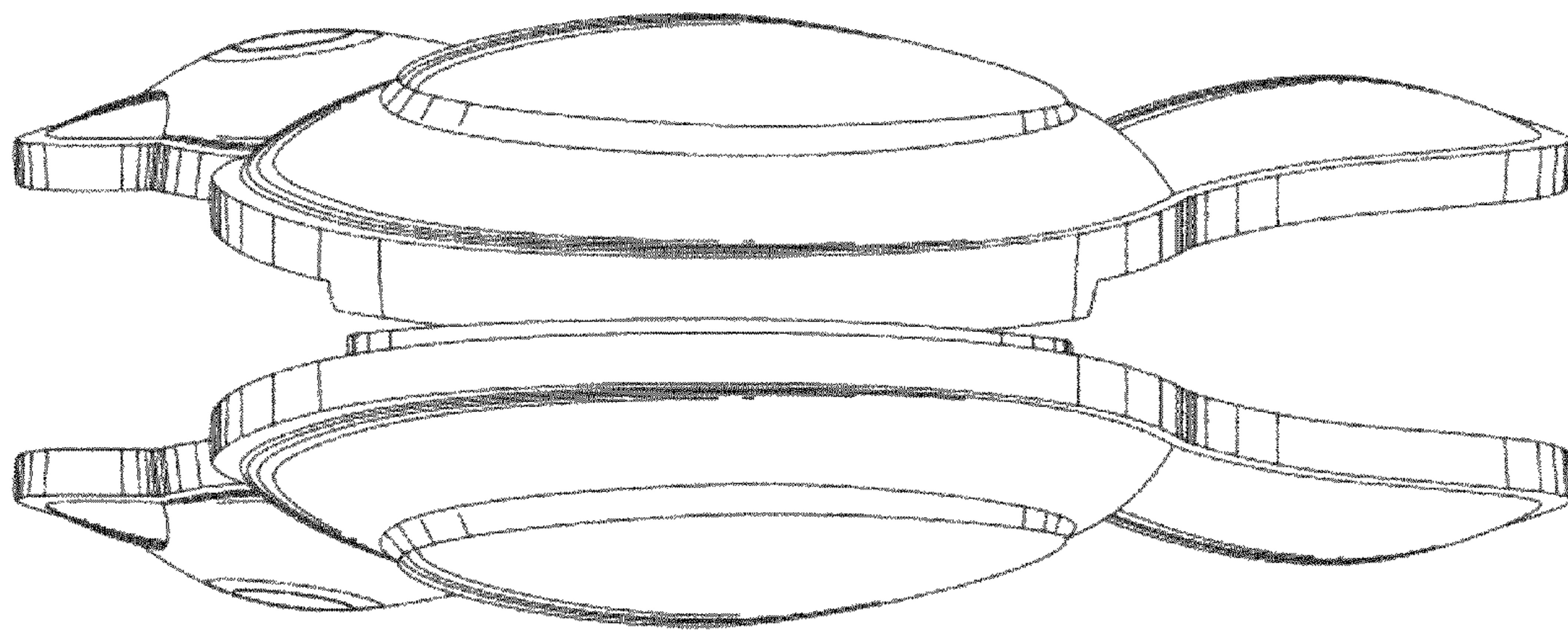

FIG. 6

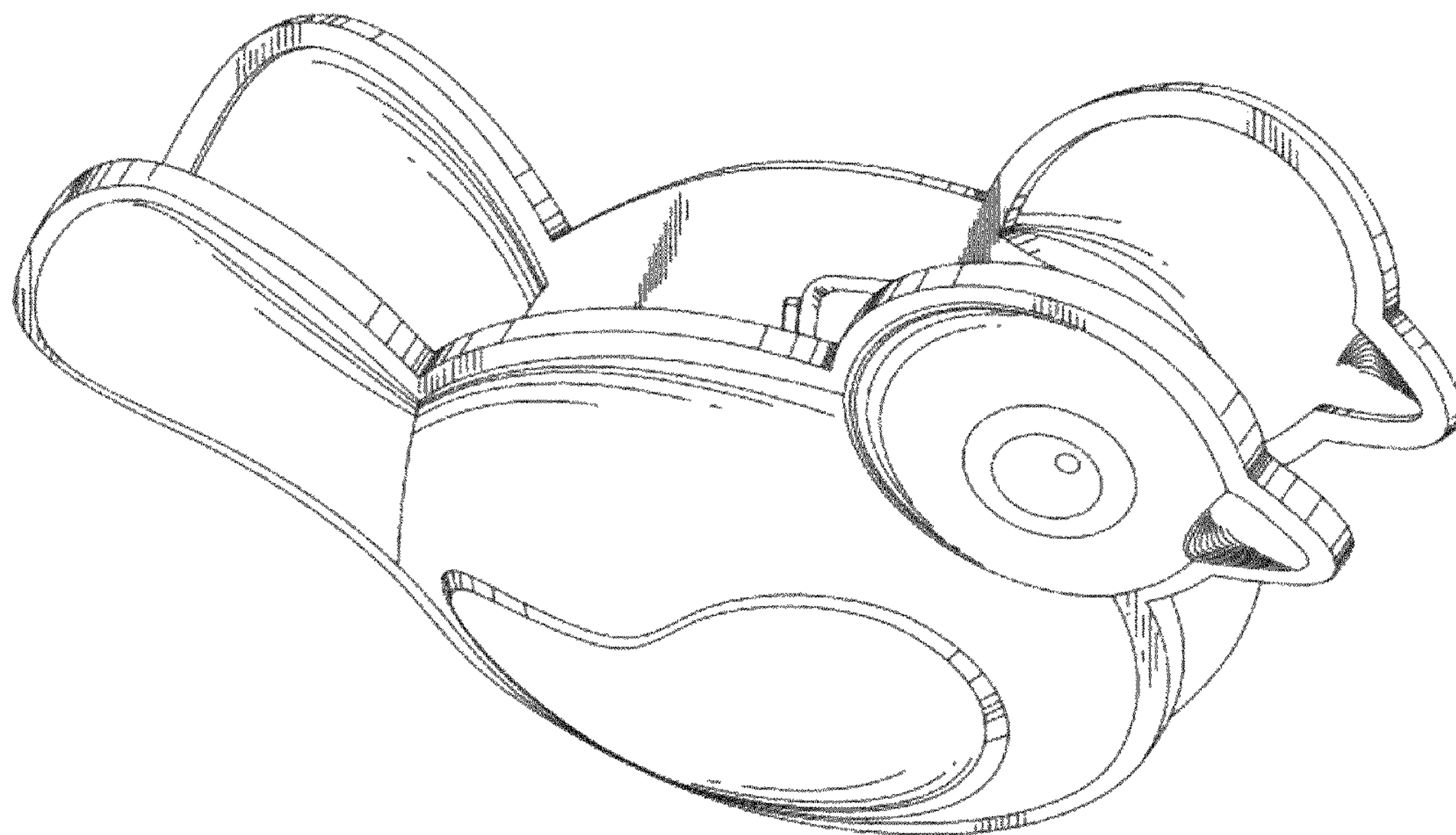

FIG. 7