



US00D671796S

(12) **United States Design Patent**
Kushner et al.

(10) **Patent No.:** **US D671,796 S**
(45) **Date of Patent:** **** Dec. 4, 2012**

(54) **KETCHUP CAP**

(75) Inventors: **Robert Gerald Kushner**, Mid Levels (HK); **Gary Stanley Seehoff**, Encino, CA (US); **Christopher Anzalone**, Foothill Ranch, CA (US)

(73) Assignee: **Evriholder Products, LLC**, Anaheim, CA (US)

(**) Term: **14 Years**

(21) Appl. No.: **29/378,630**

(22) Filed: **Nov. 7, 2010**

(51) **LOC (9) Cl.** **07-06**

(52) **U.S. Cl.** **D7/401.1**

(58) **Field of Classification Search** D7/401.1, D7/590-597, 515, 398; D9/451, 625, 614, D9/441; 206/457, 458, 527; 215/200-201, 215/228, 230, 316, 400; 222/416, 78
See application file for complete search history.

(56) **References Cited**

U.S. PATENT DOCUMENTS

3,263,872 A * 8/1966 Verona 222/416
D328,707 S * 8/1992 Isaak D9/441

D330,857 S * 11/1992 Kidd D9/451
D379,149 S * 5/1997 Powell et al. D9/451
D419,450 S * 1/2000 Adams D9/451
D419,880 S * 2/2000 Adams D9/451
D615,863 S * 5/2010 Walther D9/451
2006/0027596 A1 * 2/2006 Walther et al. 222/78

* cited by examiner

Primary Examiner — Terry Wallace

(57) **CLAIM**

The ornamental design for a ketchup cap, as shown and described.

DESCRIPTION

FIG. 1 illustrates a top view of the claimed design for a ketchup cap;
FIG. 2 illustrates a front view thereof;
FIG. 3 illustrates a left-side view thereof;
FIG. 4 illustrates a right-side view thereof;
FIG. 5 illustrates a rear view thereof;
FIG. 6 illustrates a bottom view thereof;
FIG. 7 illustrates a cross sectional view thereof taken along line 7-7 of FIG. 2; and,
FIG. 8 illustrates a perspective view thereof.

1 Claim, 8 Drawing Sheets

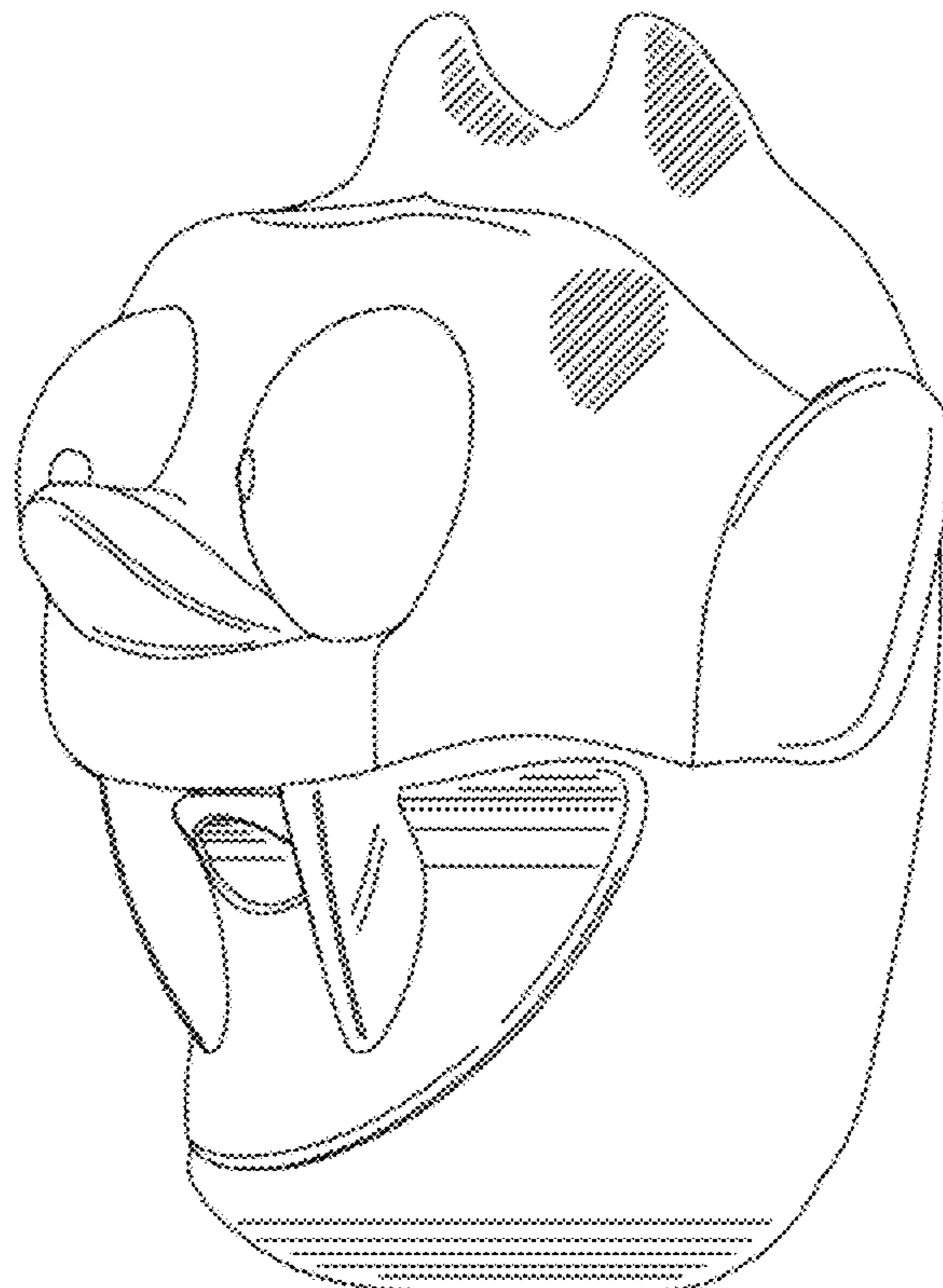

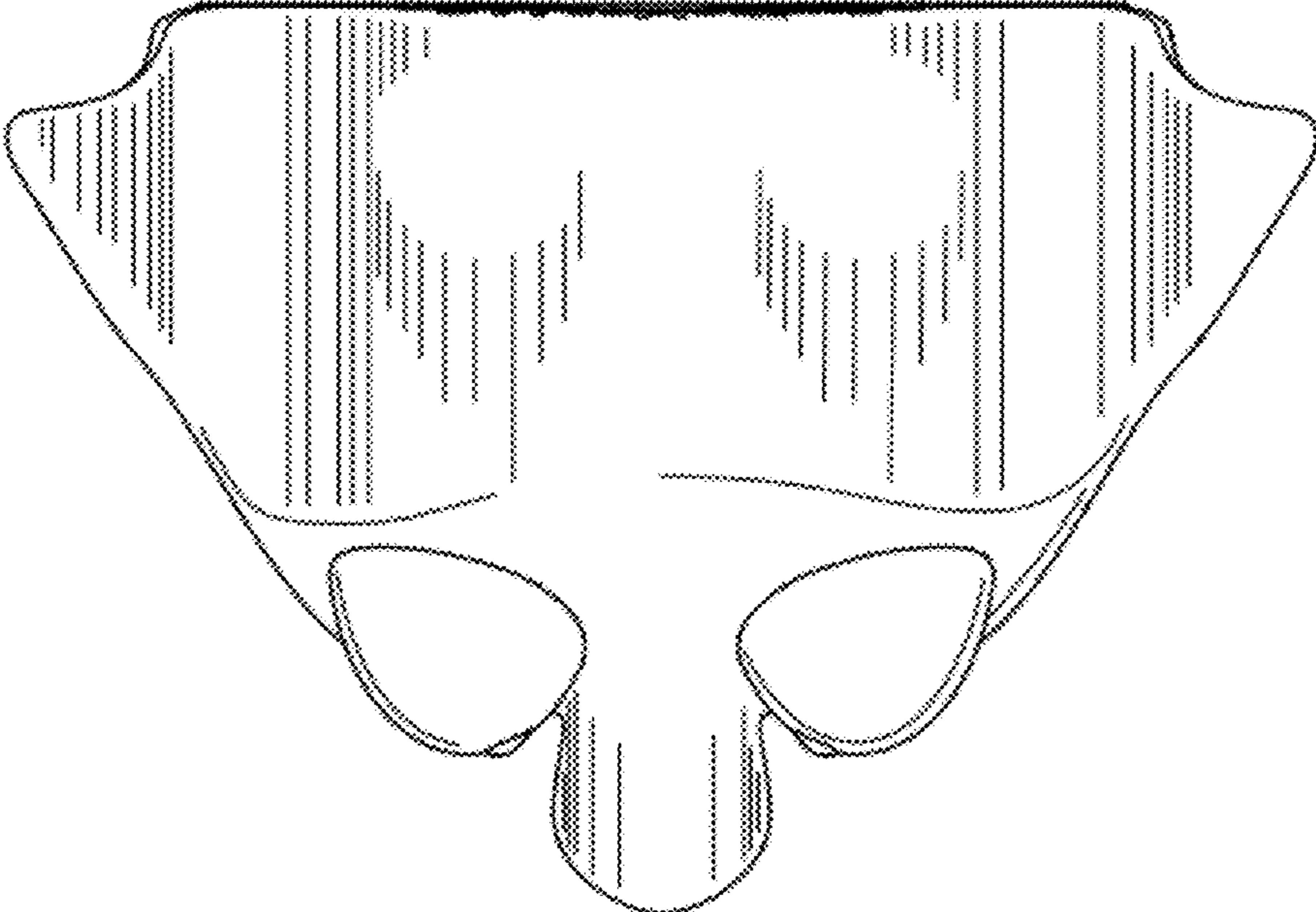

Fig. 1

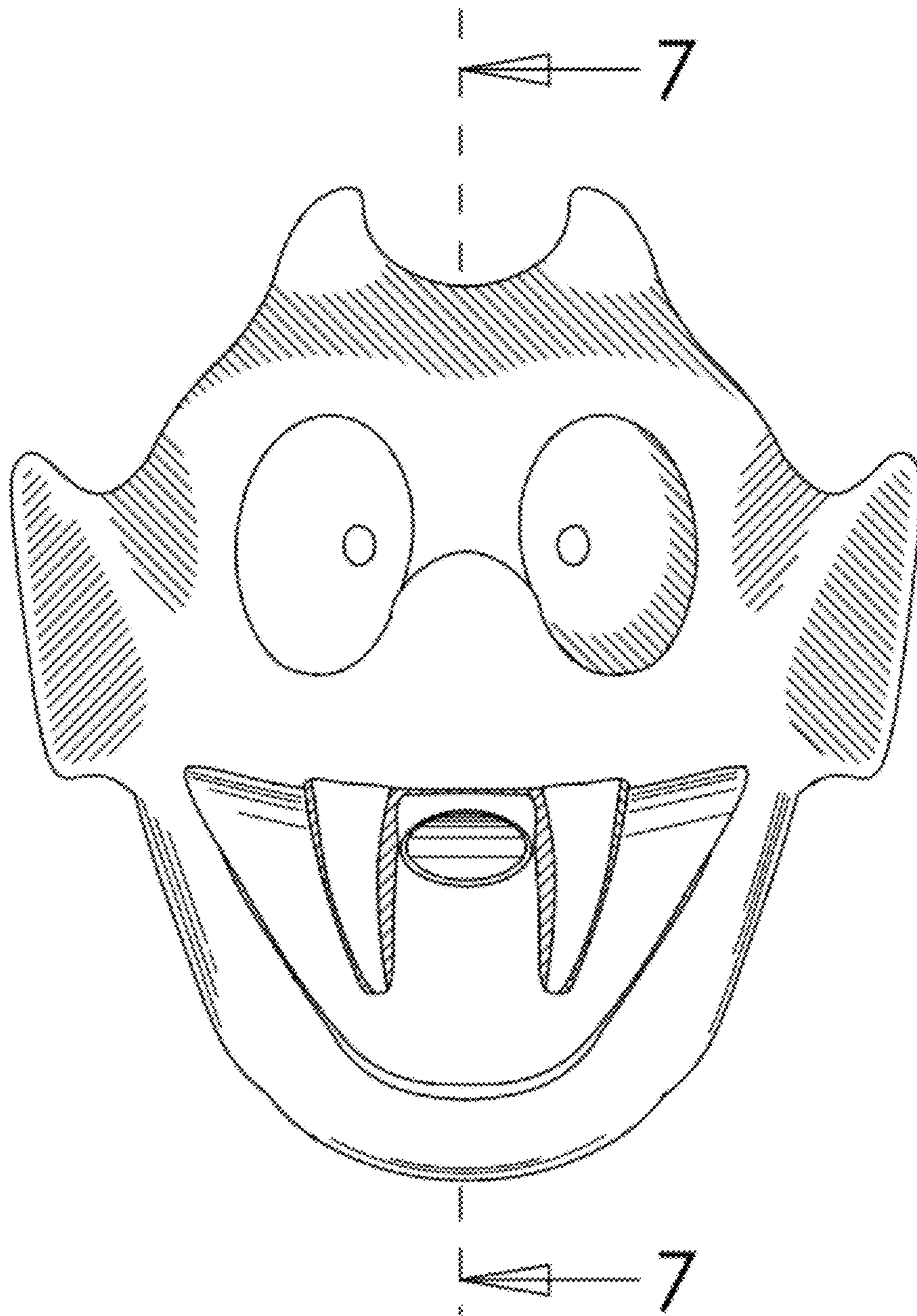

Fig. 2

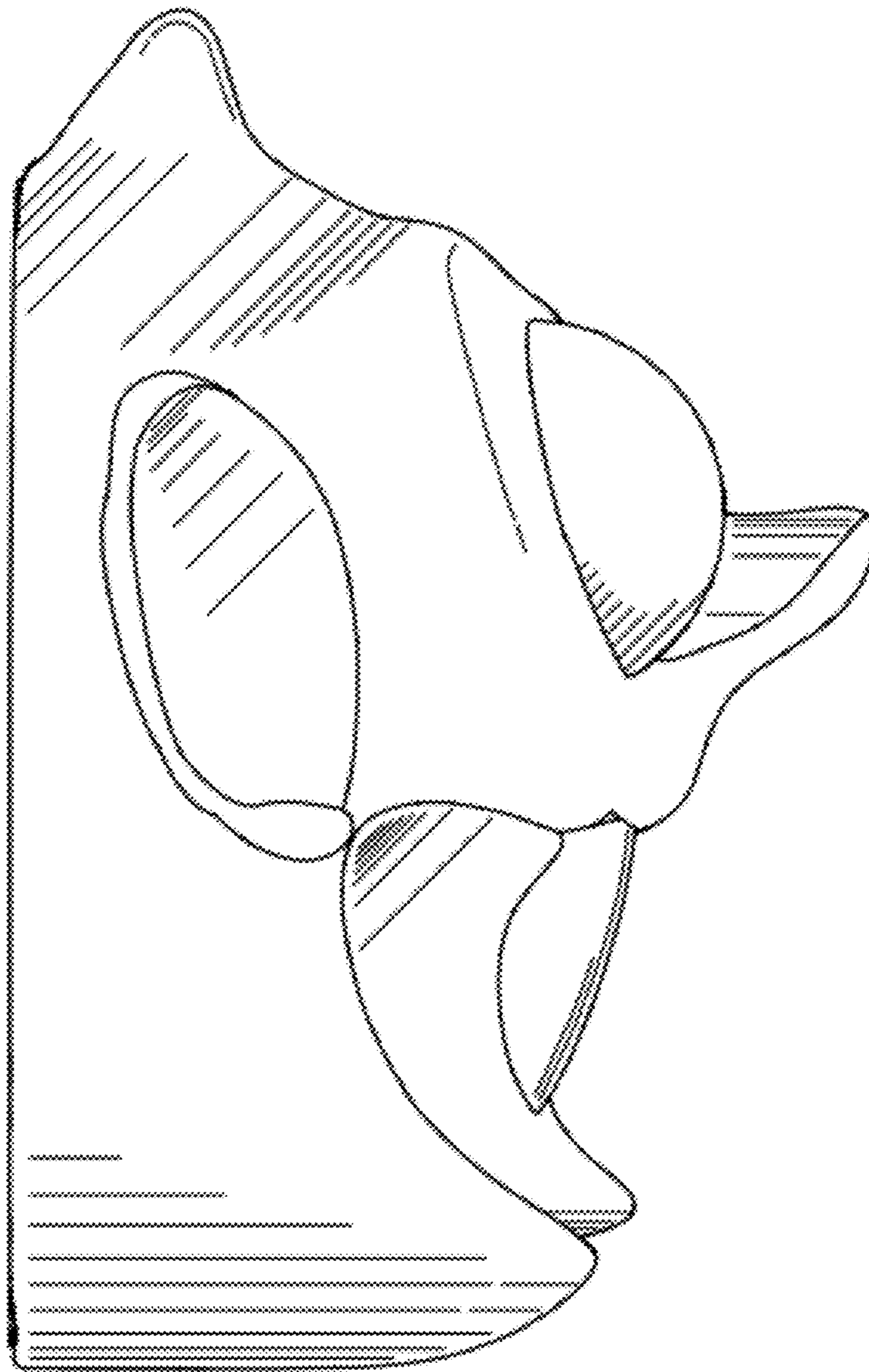

Fig. 3

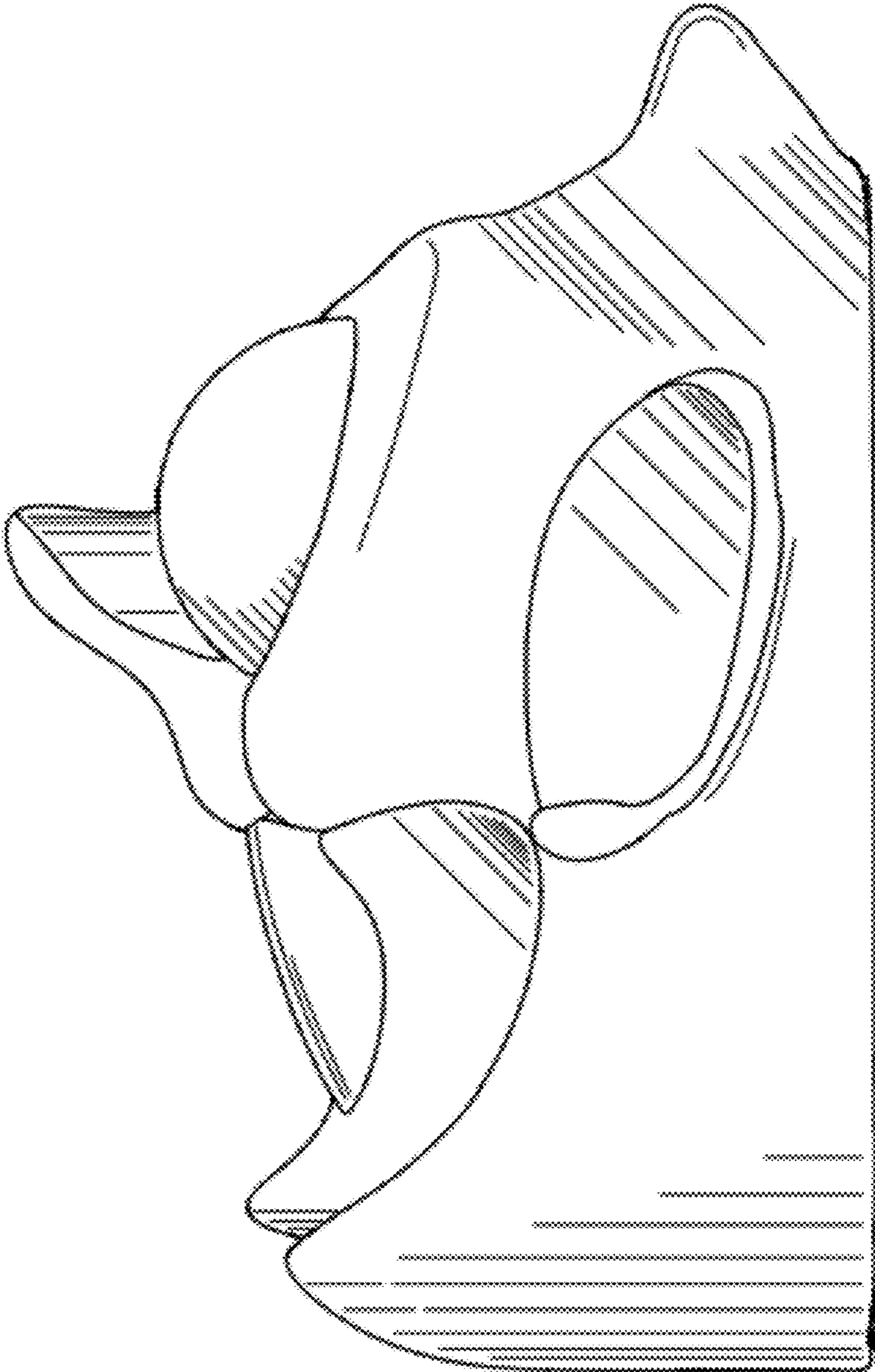

Fig. 4

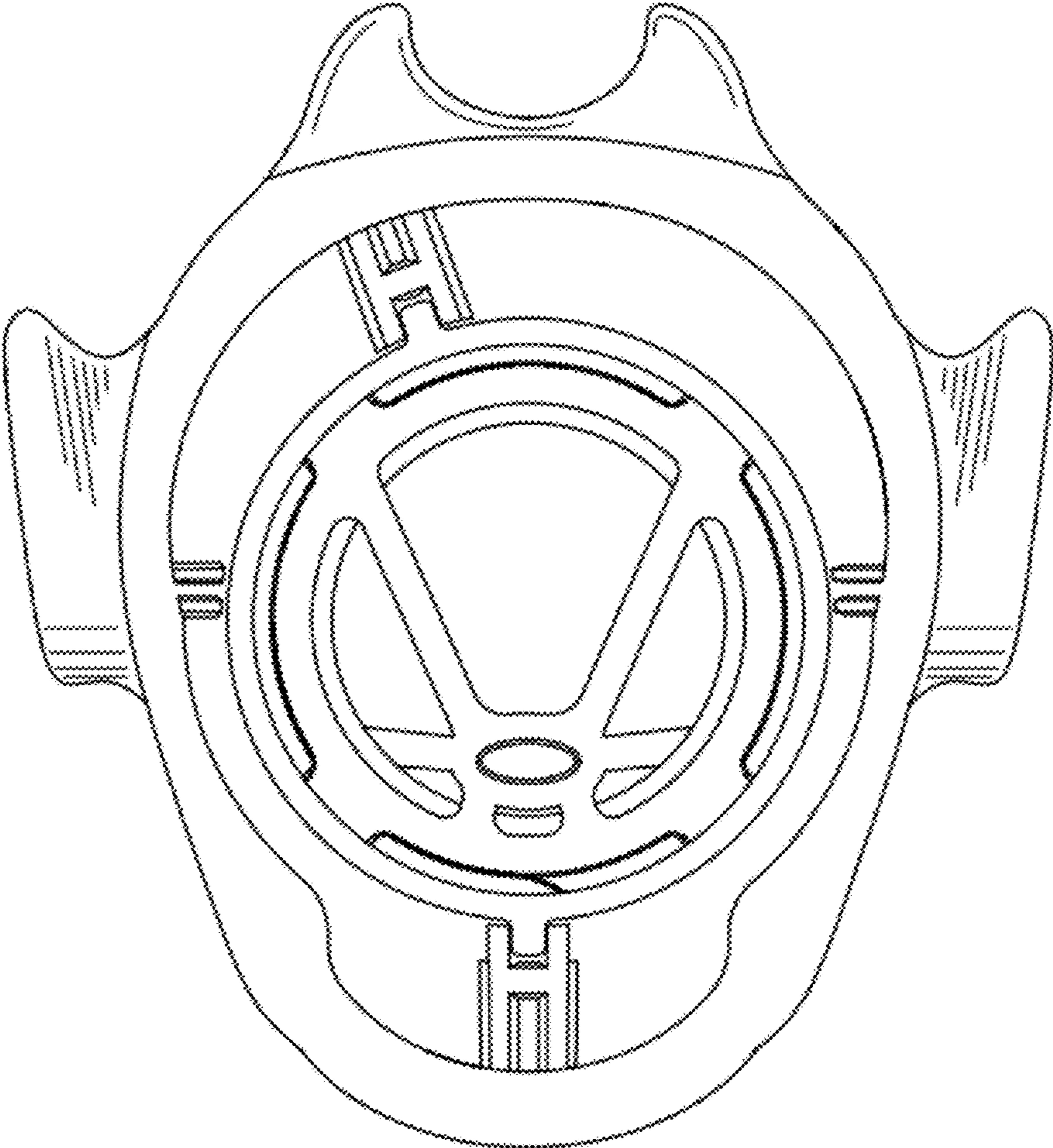

Fig. 5

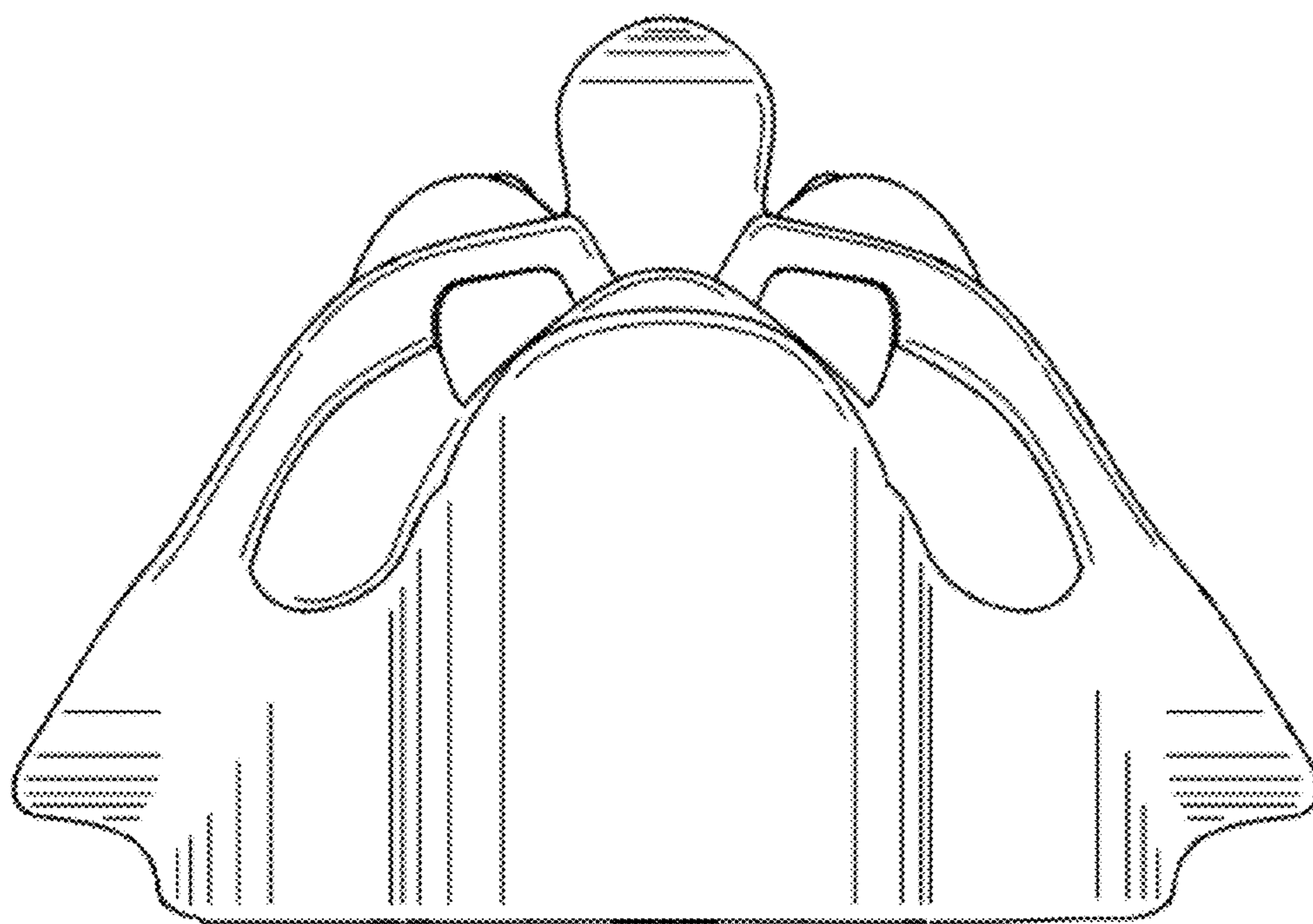

Fig. 6

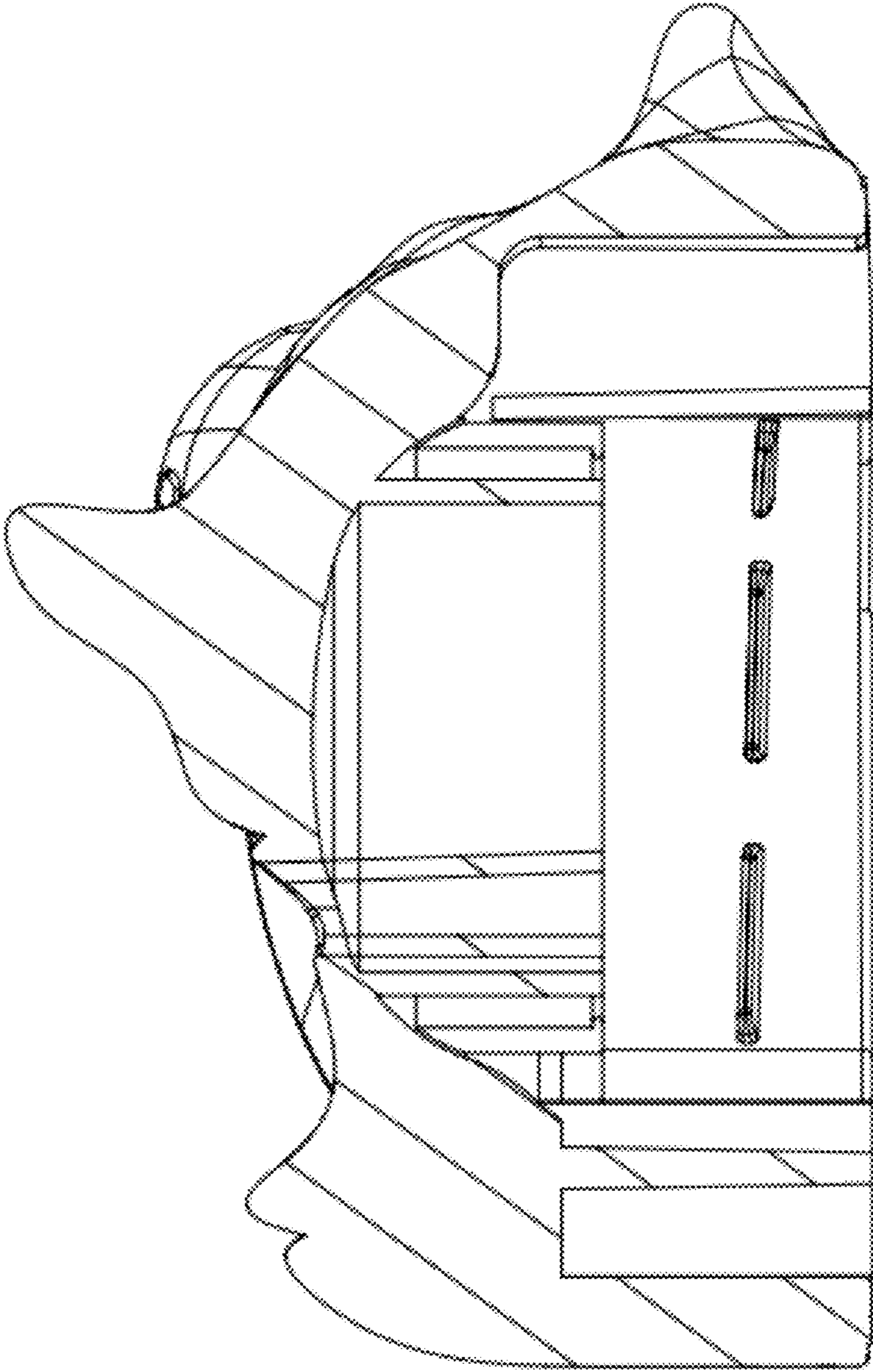

Fig. 7

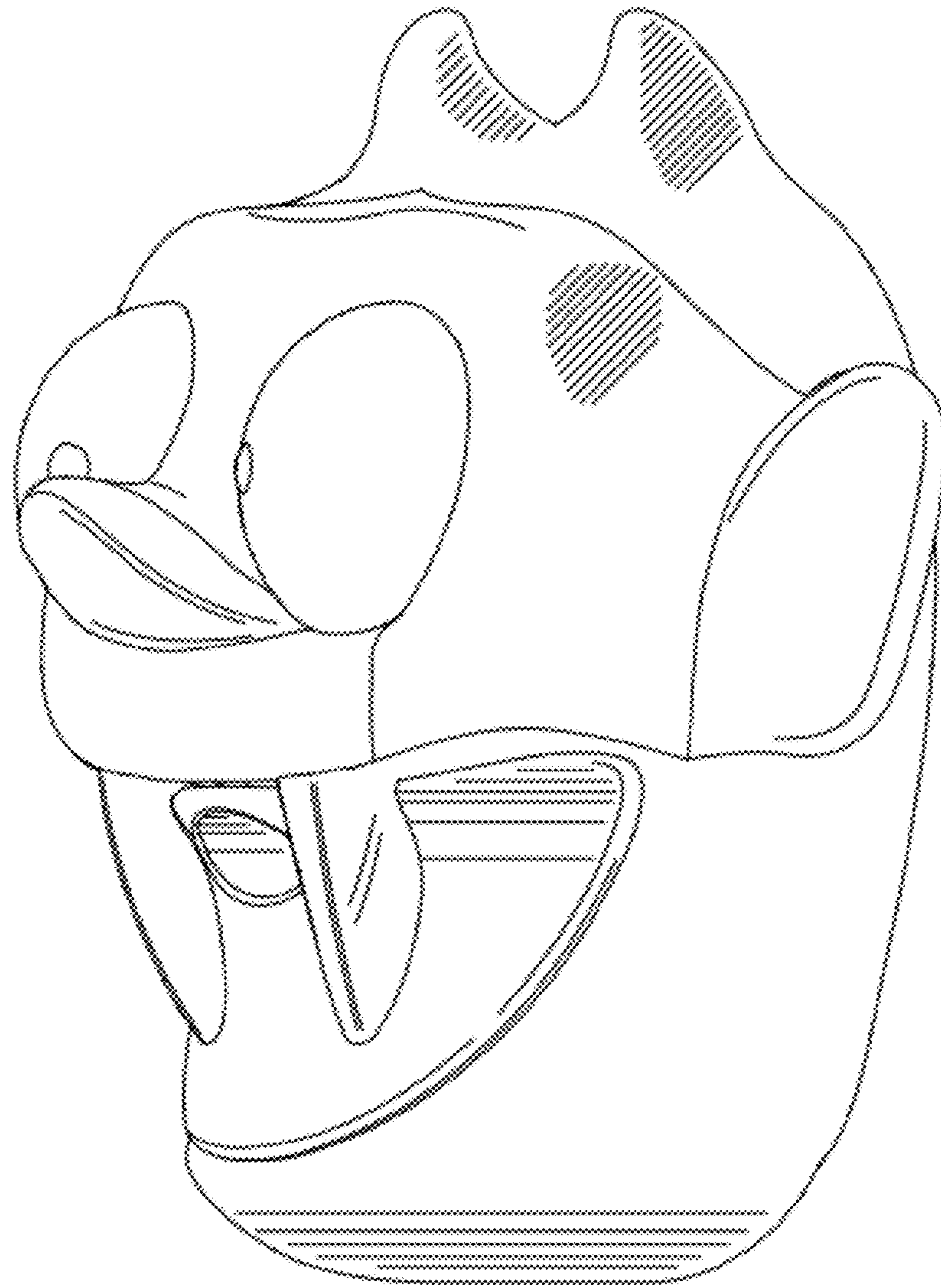

Fig. 8