



US00D671740S

(12) **United States Design Patent**
Guichot

(10) **Patent No.:** **US D671,740 S**
(45) **Date of Patent:** **** Dec. 4, 2012**

(54) **HANDBAG**

(75) Inventor: **Isabelle Guichot**, Paris (FR)

(73) Assignee: **Balenciaga**, Paris (FR)

(**) Term: **14 Years**

(21) Appl. No.: **29/400,266**

(22) Filed: **Aug. 25, 2011**

(30) **Foreign Application Priority Data**

Feb. 28, 2011 (EM) 001262828-0002

(51) **LOC (9) Cl.** **03-01**

(52) **U.S. Cl.** **D3/243**

(58) **Field of Classification Search** D3/232-233,
D3/240-245; 150/100, 103-110, 113-114,
150/117-119

See application file for complete search history.

(56) **References Cited**

U.S. PATENT DOCUMENTS

D534,723 S * 1/2007 Fusi D3/243
D566,385 S * 4/2008 Yuson D3/232

* cited by examiner

Primary Examiner — Holly Baynham

(74) *Attorney, Agent, or Firm* — Collen IP; Donald J. Ranft

(57) **CLAIM**

The ornamental design for a handbag, as shown.

DESCRIPTION

FIG. 1 is a front left side perspective view of a handbag showing our new design;

FIG. 2 is a bottom side up perspective view thereof;

FIG. 3 is a top view thereof;

FIG. 4 is a bottom view thereof;

FIG. 5 is a left side view thereof;

FIG. 6 is a right side view thereof;

FIG. 7 is a front view thereof; and,

FIG. 8 is a rear view thereof.

The broken lines representing stitching are part of the claimed design.

1 Claim, 7 Drawing Sheets

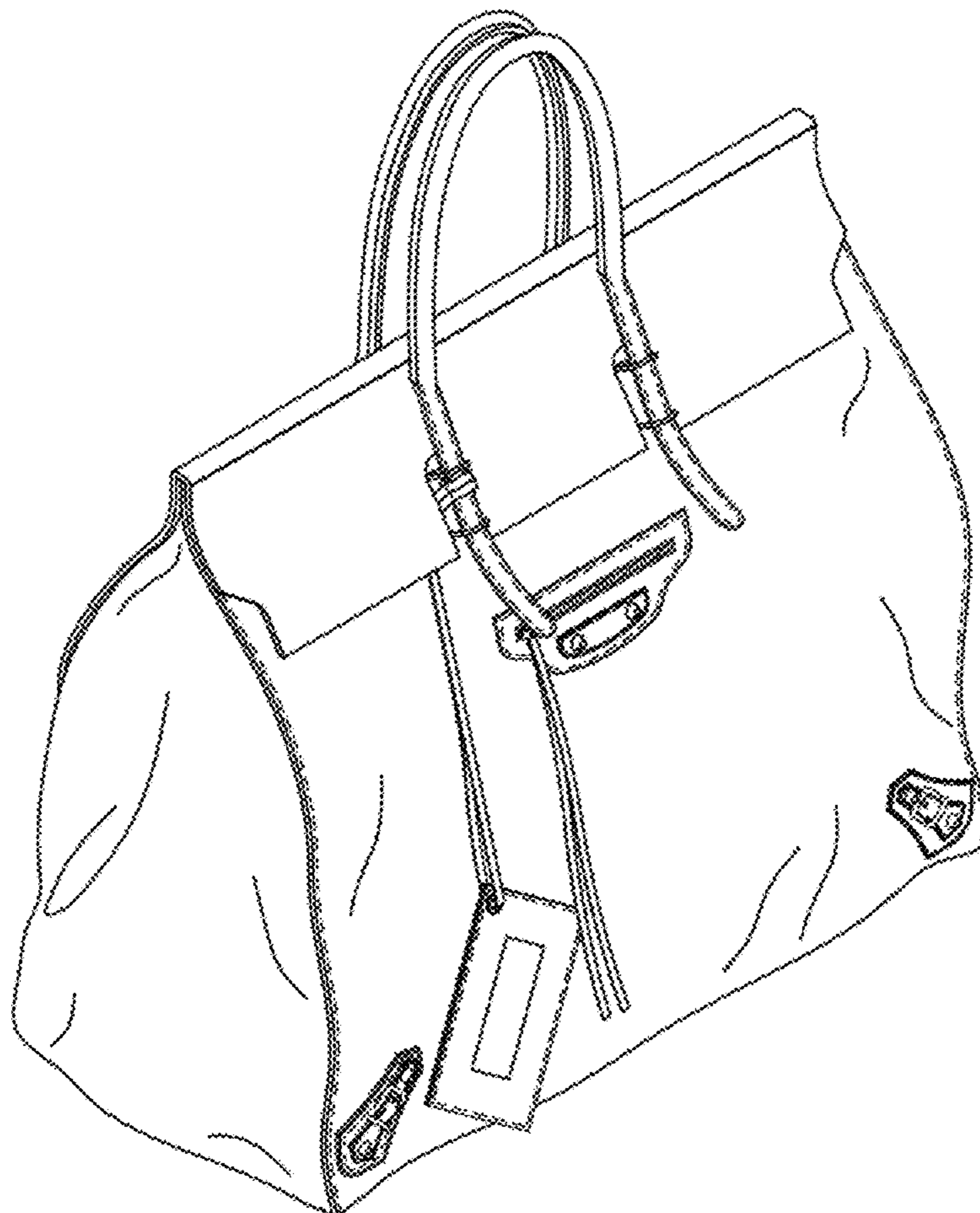

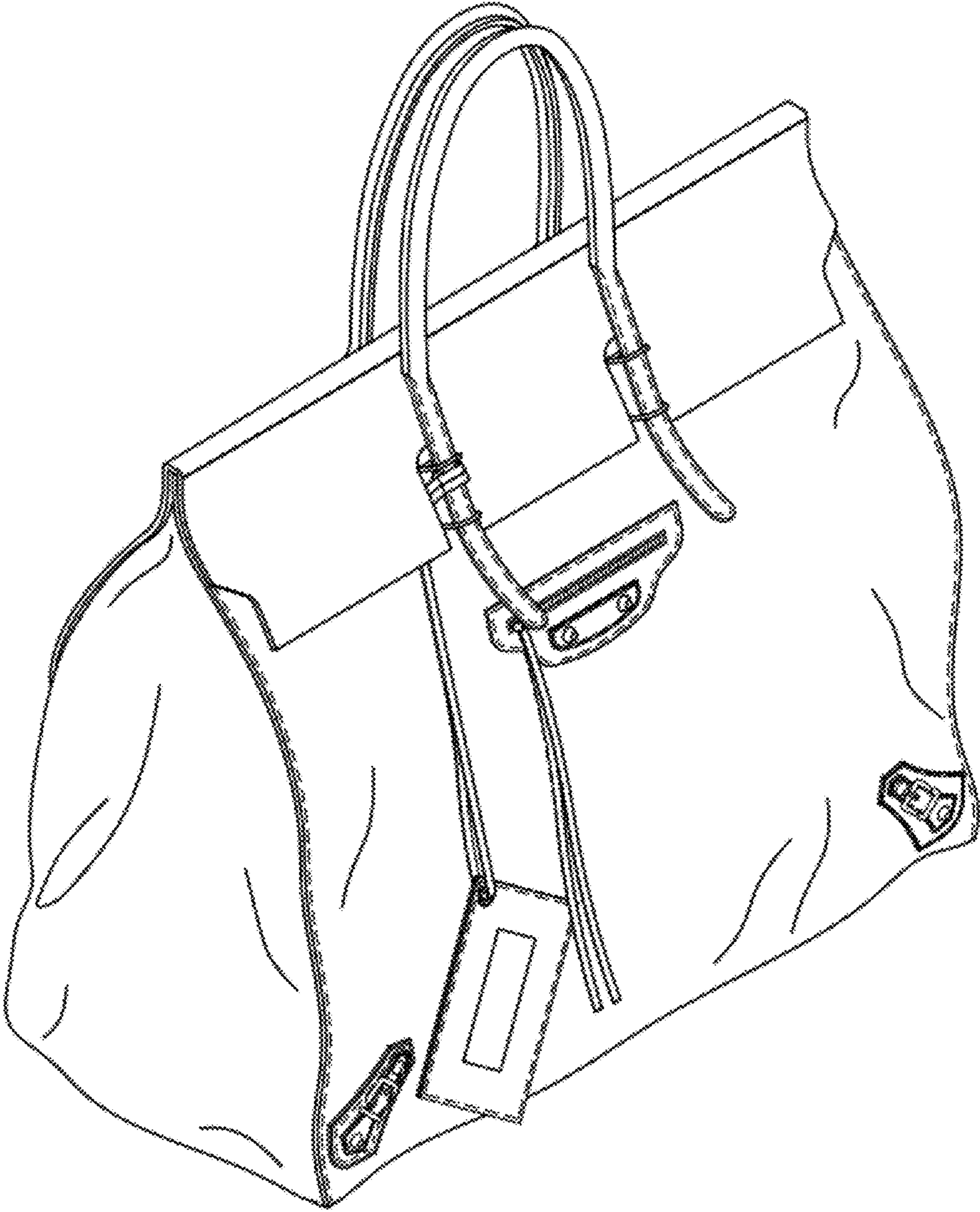

FIG. 1

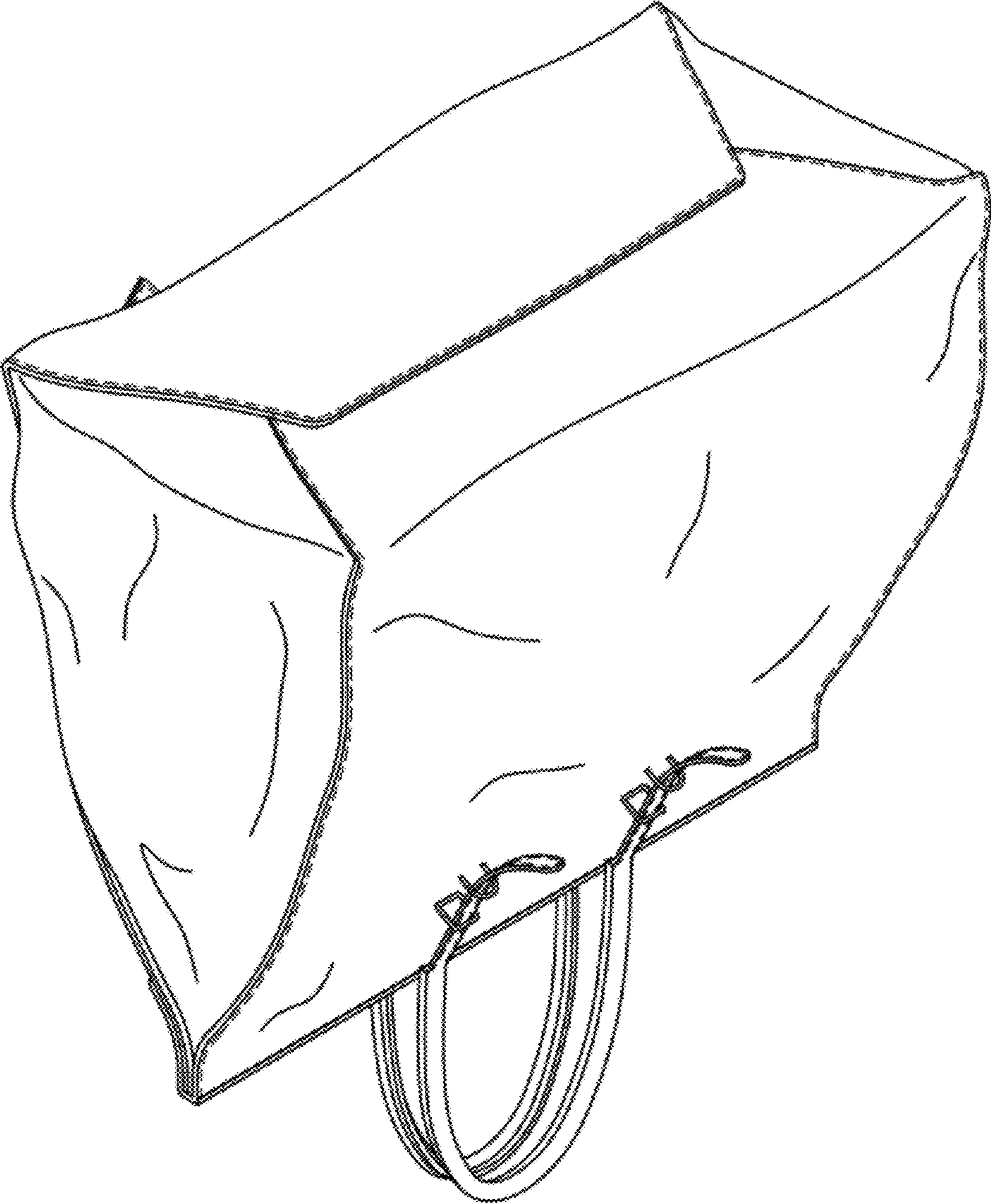

FIG. 2

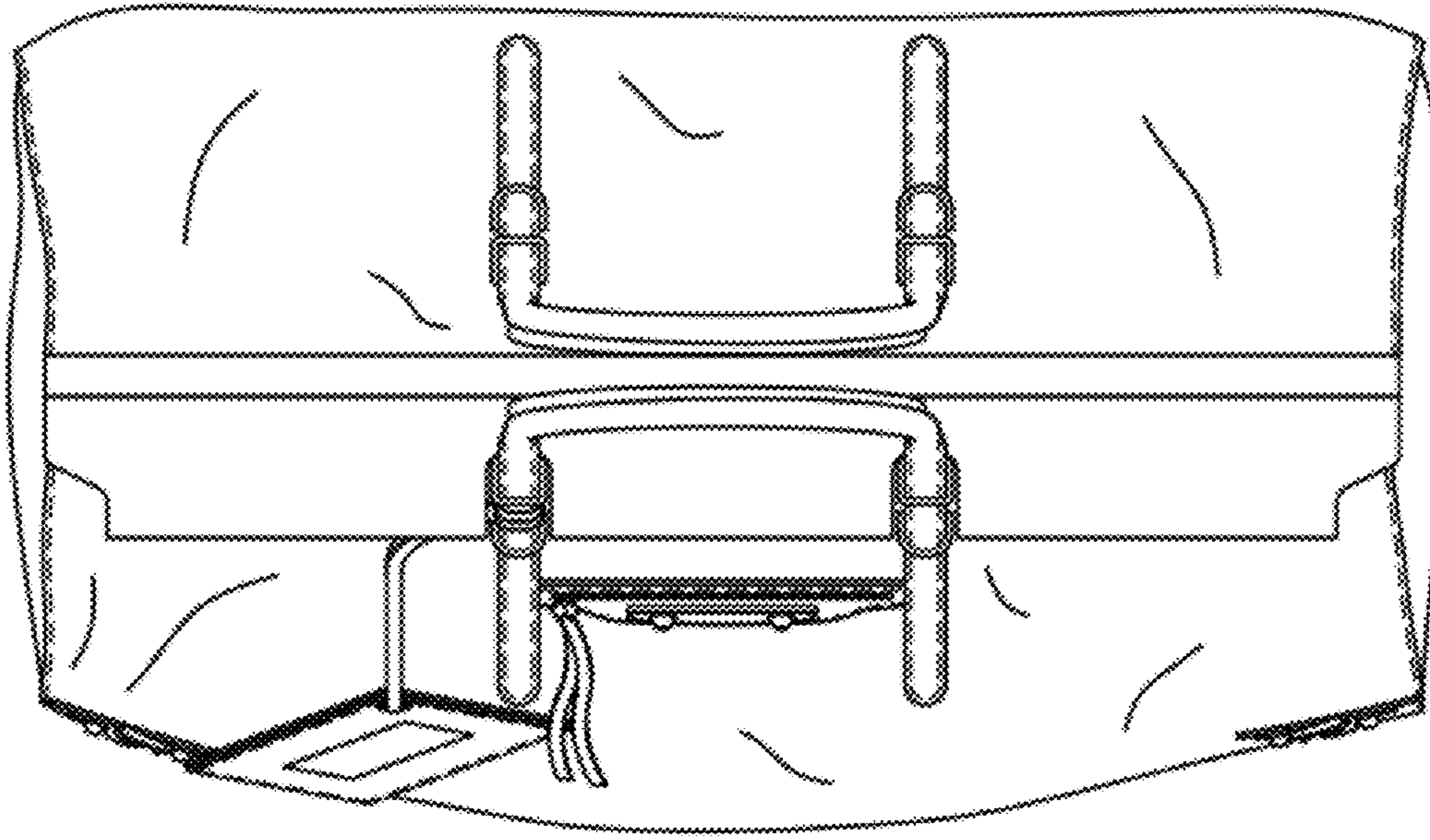

FIG. 3

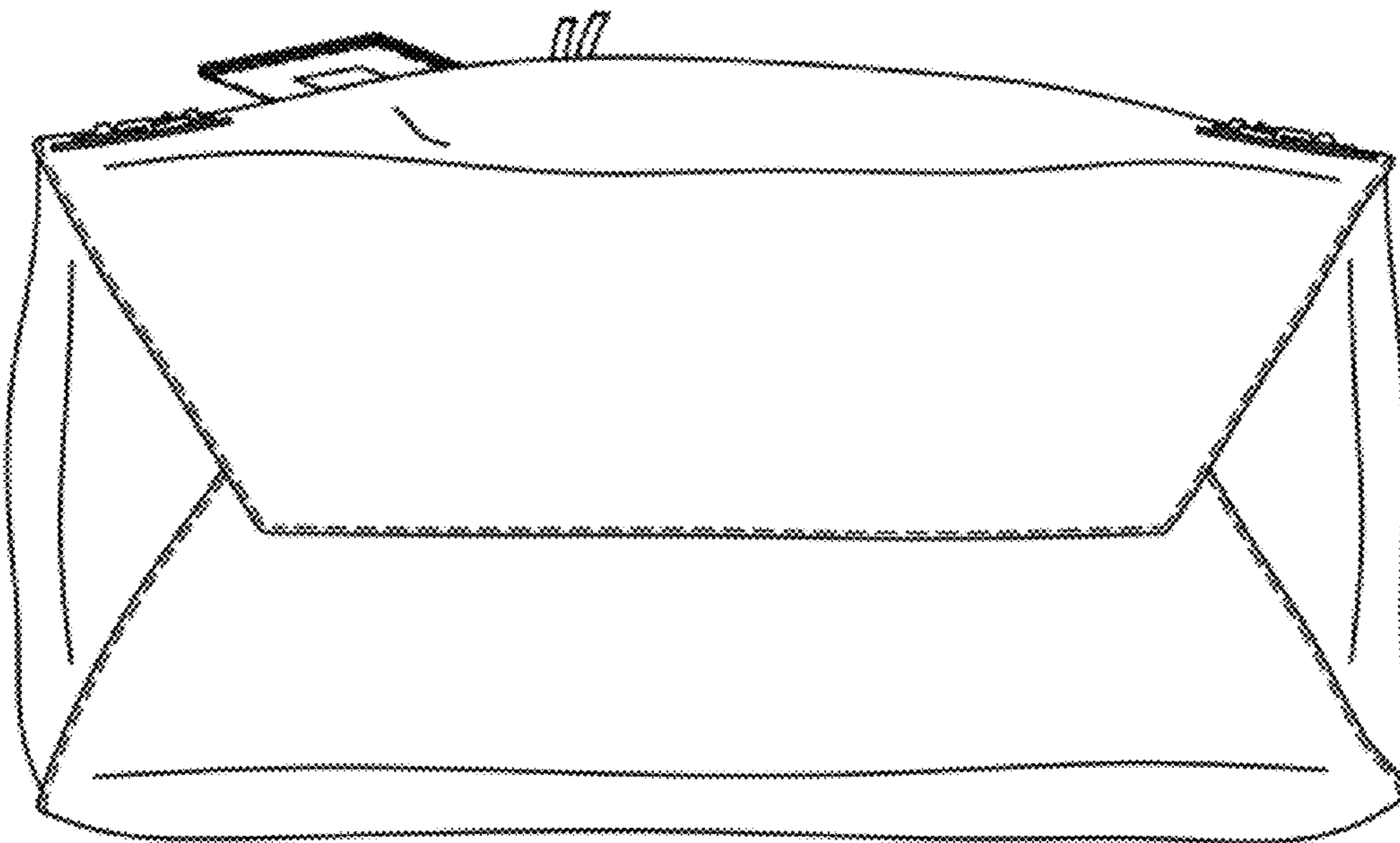

FIG. 4

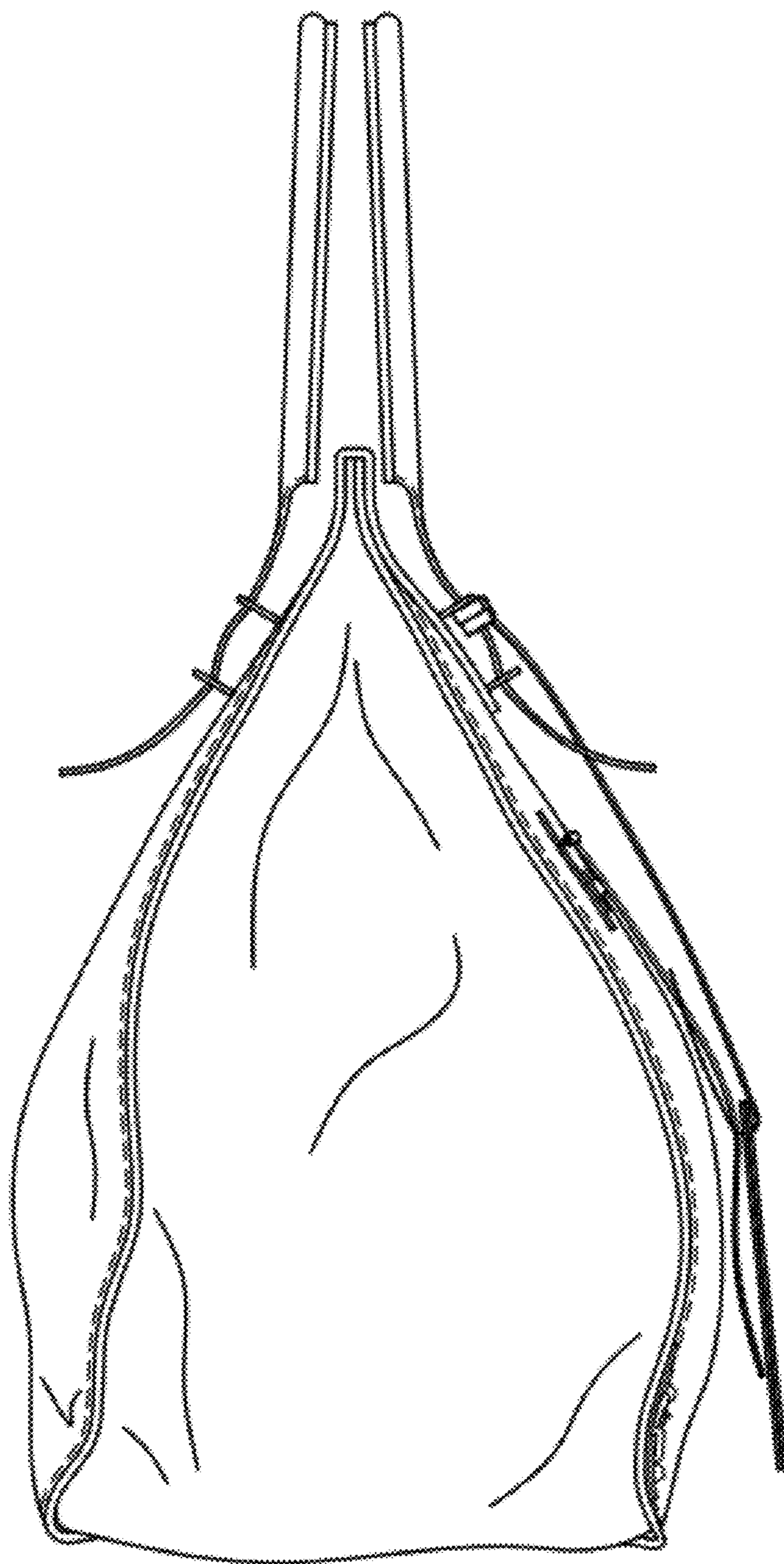

FIG. 5

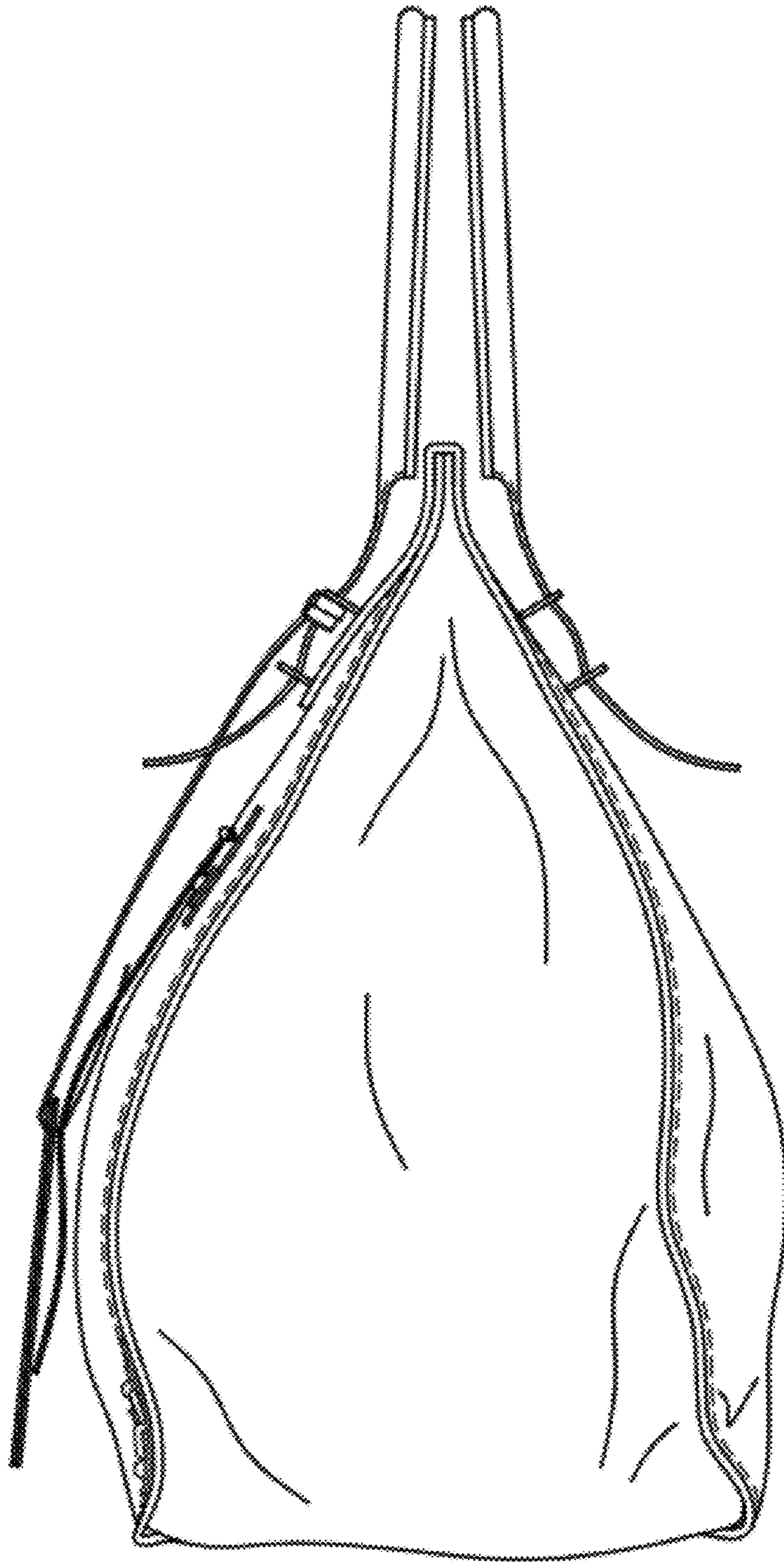

FIG. 6



FIG. 7



FIG. 8