



US00D671701S

(12) **United States Design Patent**
Tanoue et al.

(10) **Patent No.:** **US D671,701 S**
(45) **Date of Patent:** **** Nov. 27, 2012**

(54) **STEAM IRON**

(75) Inventors: **Masahiko Tanoue**, Shiga (JP); **Syuuichi Hosoda**, Shiga (JP); **Kiyooki Konno**, Nara (JP); **Yuko Okabe**, Osaka (JP)

(73) Assignee: **Panasonic Corporation**, Osaka (JP)

(**) Term: **14 Years**

(21) Appl. No.: **29/427,082**

(22) Filed: **Jul. 13, 2012**

(51) **LOC (9) Cl.** **07-05**

(52) **U.S. Cl.** **D32/70**

(58) **Field of Classification Search** D32/73,
D32/72, 71, 70, 69, 68, 35; 392/404; 38/97,
38/96, 93, 88, 77.9, 77.83, 77.82, 77.81,
38/77.8, 77.7, 77.6, 77.5, 77.3, 77.1; 219/251,
219/245

See application file for complete search history.

(56) **References Cited**

U.S. PATENT DOCUMENTS

D128,666 S *	8/1941	Huffman	D32/70
D516,764 S *	3/2006	Kihara	D32/70
D541,502 S *	4/2007	Powell	D32/70
D552,818 S *	10/2007	Powell	D32/70
D552,820 S *	10/2007	Powell	D32/70
D555,315 S *	11/2007	Poon	D32/70
D567,461 S *	4/2008	Poon	D32/69
D567,462 S *	4/2008	Renault et al.	D32/70
D599,070 S *	8/2009	Hosoda et al.	D32/68
D621,115 S *	8/2010	Lee et al.	D32/70
D629,989 S	12/2010	Höllerich et al.		
D629,991 S *	12/2010	Day et al.	D32/70

D632,863 S *	2/2011	Massip et al.	D32/70
D642,762 S *	8/2011	Ågren et al.	D32/70
D645,629 S *	9/2011	Powell	D32/70
D646,446 S *	10/2011	Raven	D32/17
8,205,364 B2 *	6/2012	Shimosaka et al.	38/79

FOREIGN PATENT DOCUMENTS

CN	200830064005.6	6/2008
EM	001251235-0001	12/2010
JP	1385289	4/2010

* cited by examiner

Primary Examiner — Austin Murphy

(74) *Attorney, Agent, or Firm* — Brinks Hofer Gilson & Lione

(57) **CLAIM**

We claim the ornamental design for a steam iron, as shown and described.

DESCRIPTION

FIG. 1 is a front perspective view of a steam iron of the present invention;

FIG. 2 is a rear perspective view thereof;

FIG. 3 is a first side view thereof;

FIG. 4 is a second side view thereof;

FIG. 5 is a top view thereof;

FIG. 6 is a bottom view thereof;

FIG. 7 is a front view thereof; and,

FIG. 8 is a rear view thereof.

The broken lines shown represent unclaimed subject matter and form no part of the claimed design. Additionally, the unevenly broken lines in the drawings define the limits of the claimed design.

1 Claim, 8 Drawing Sheets

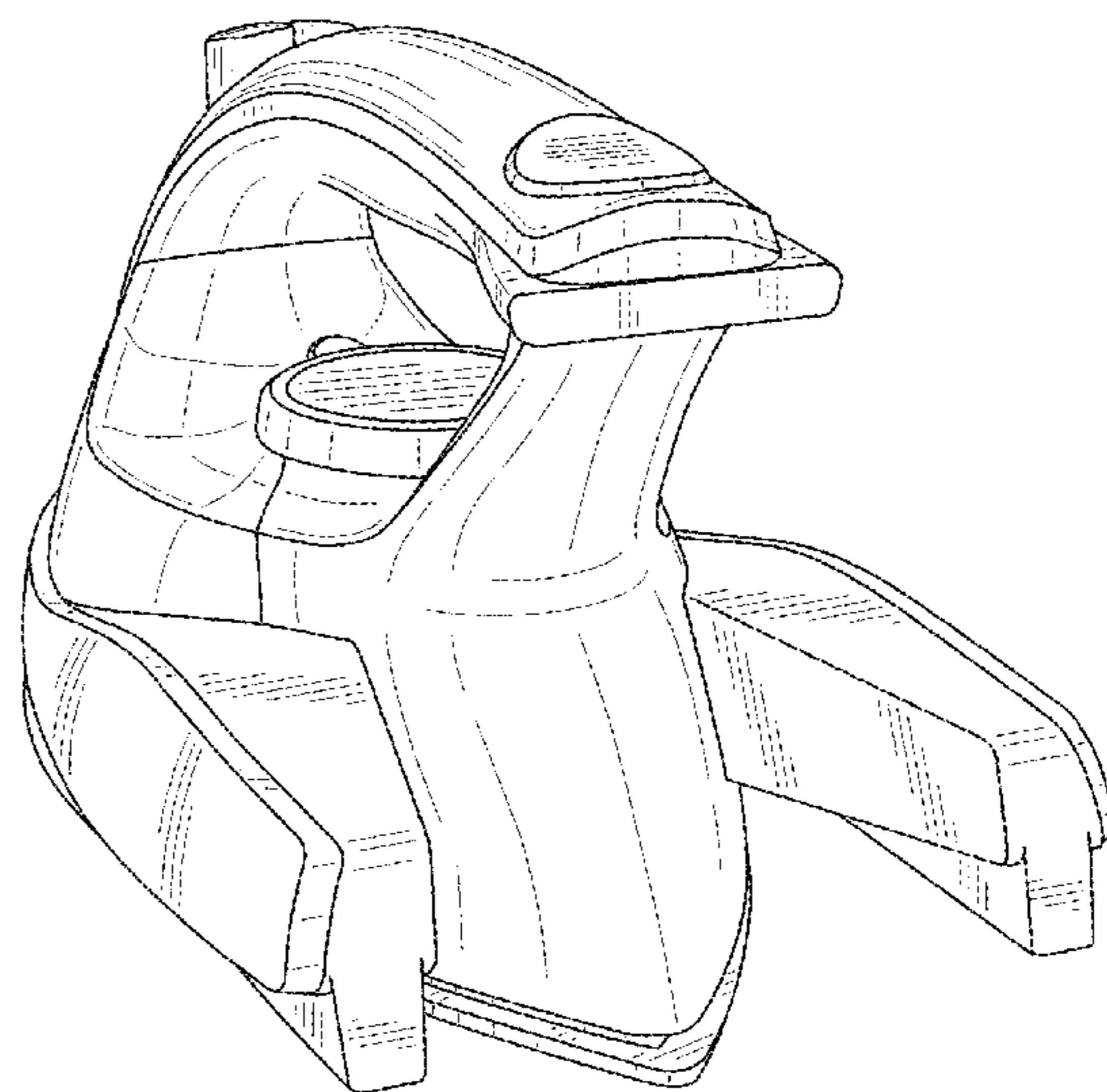
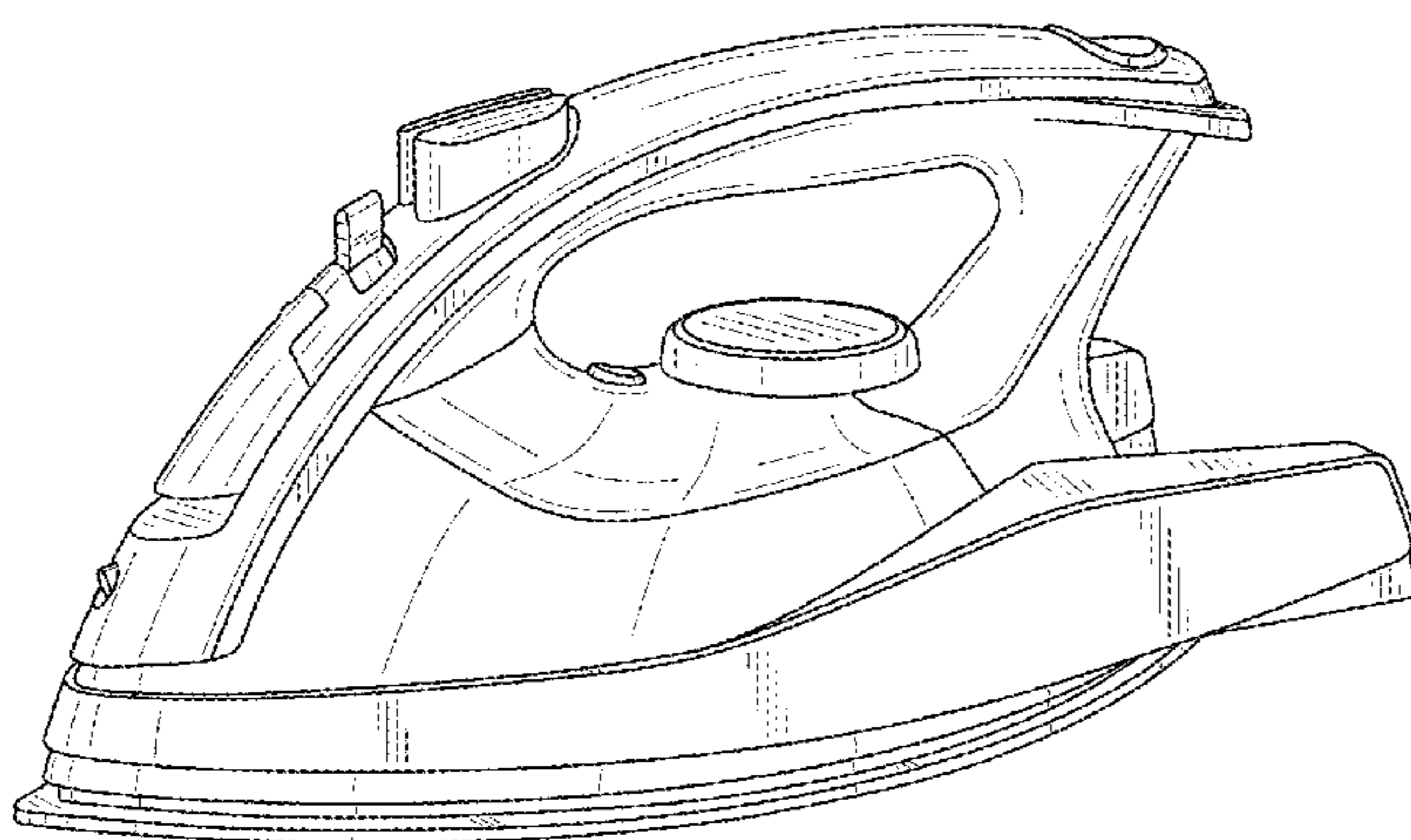

FIG.1

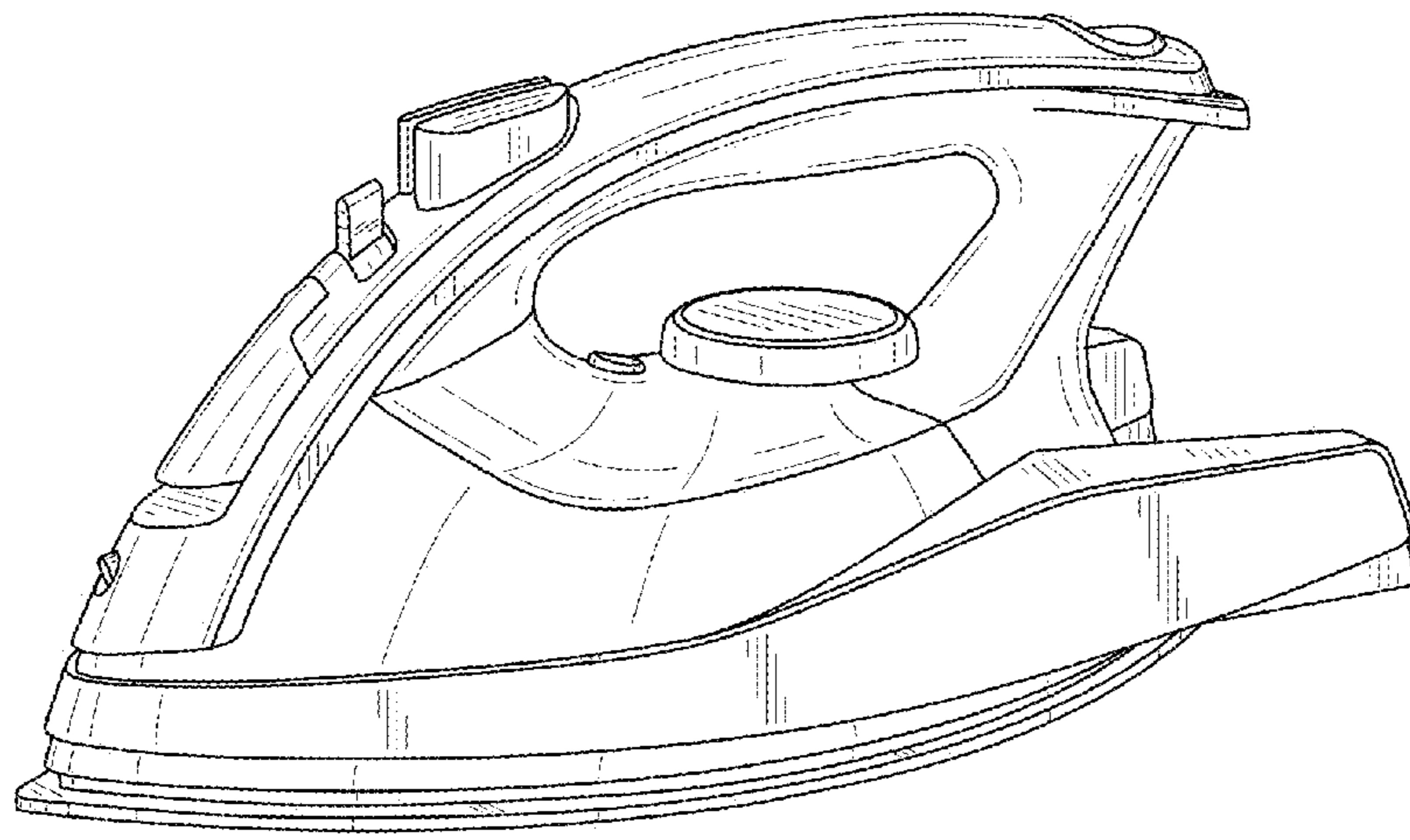

FIG.2

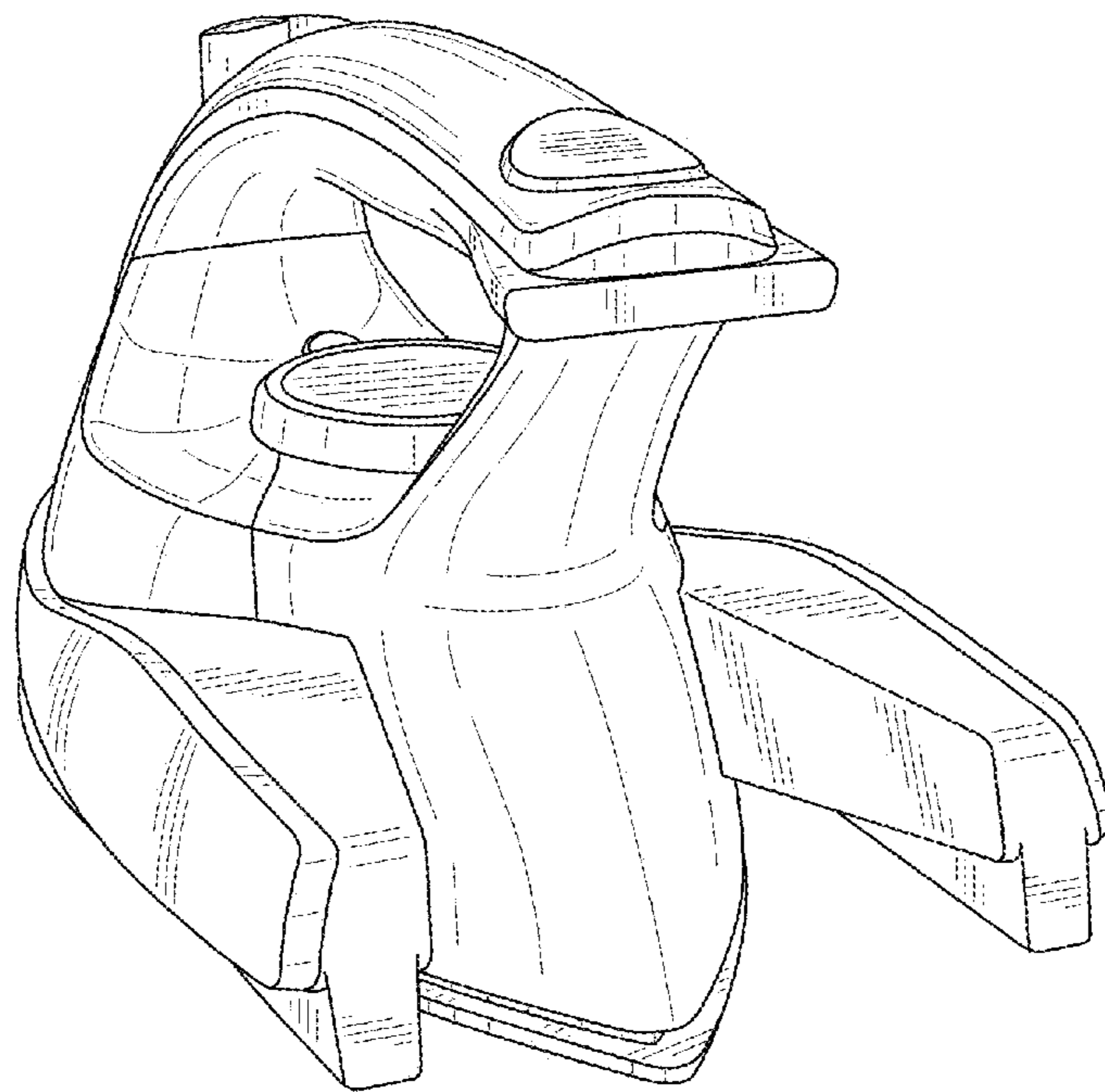

FIG.3

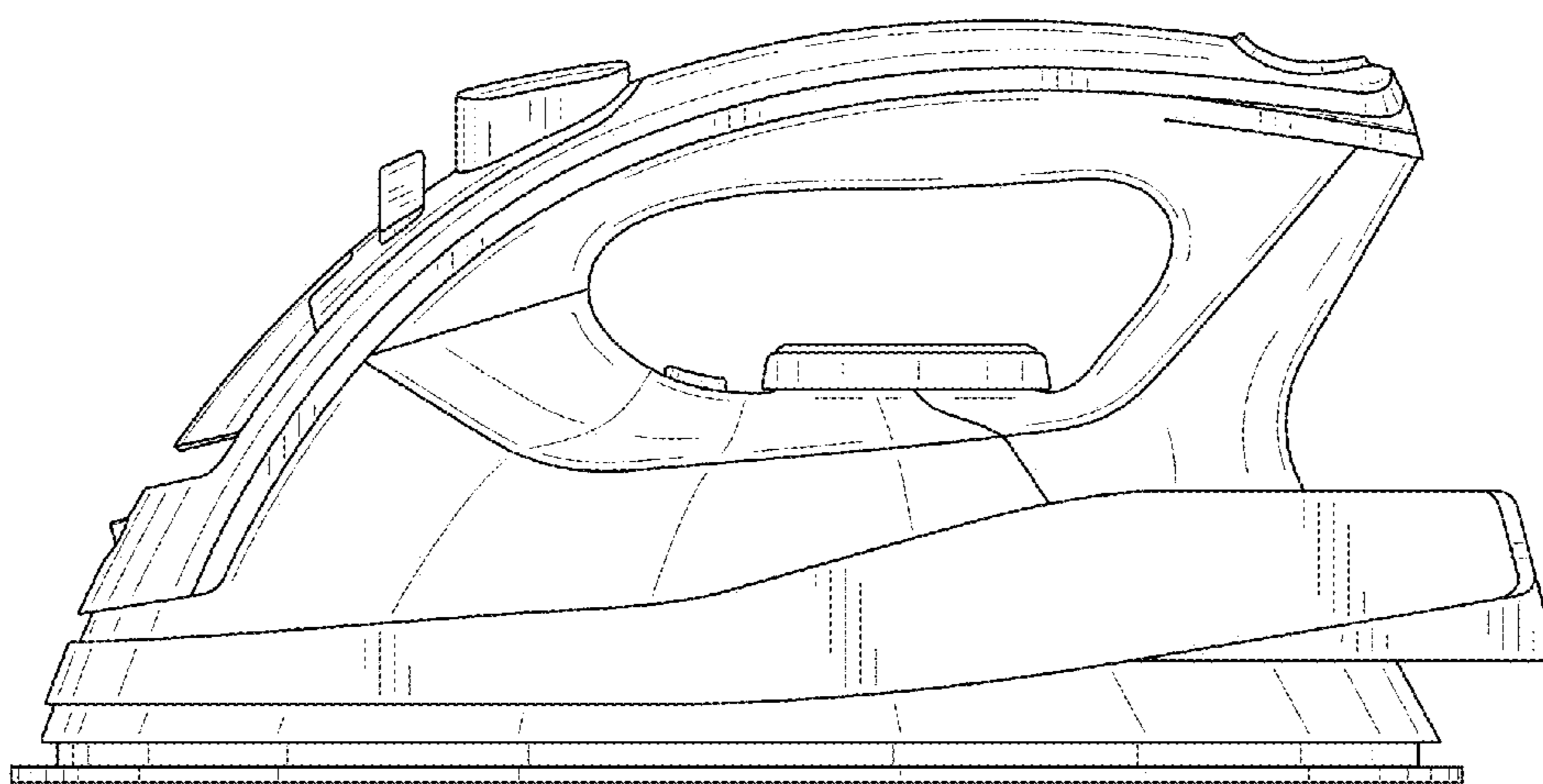

FIG.4

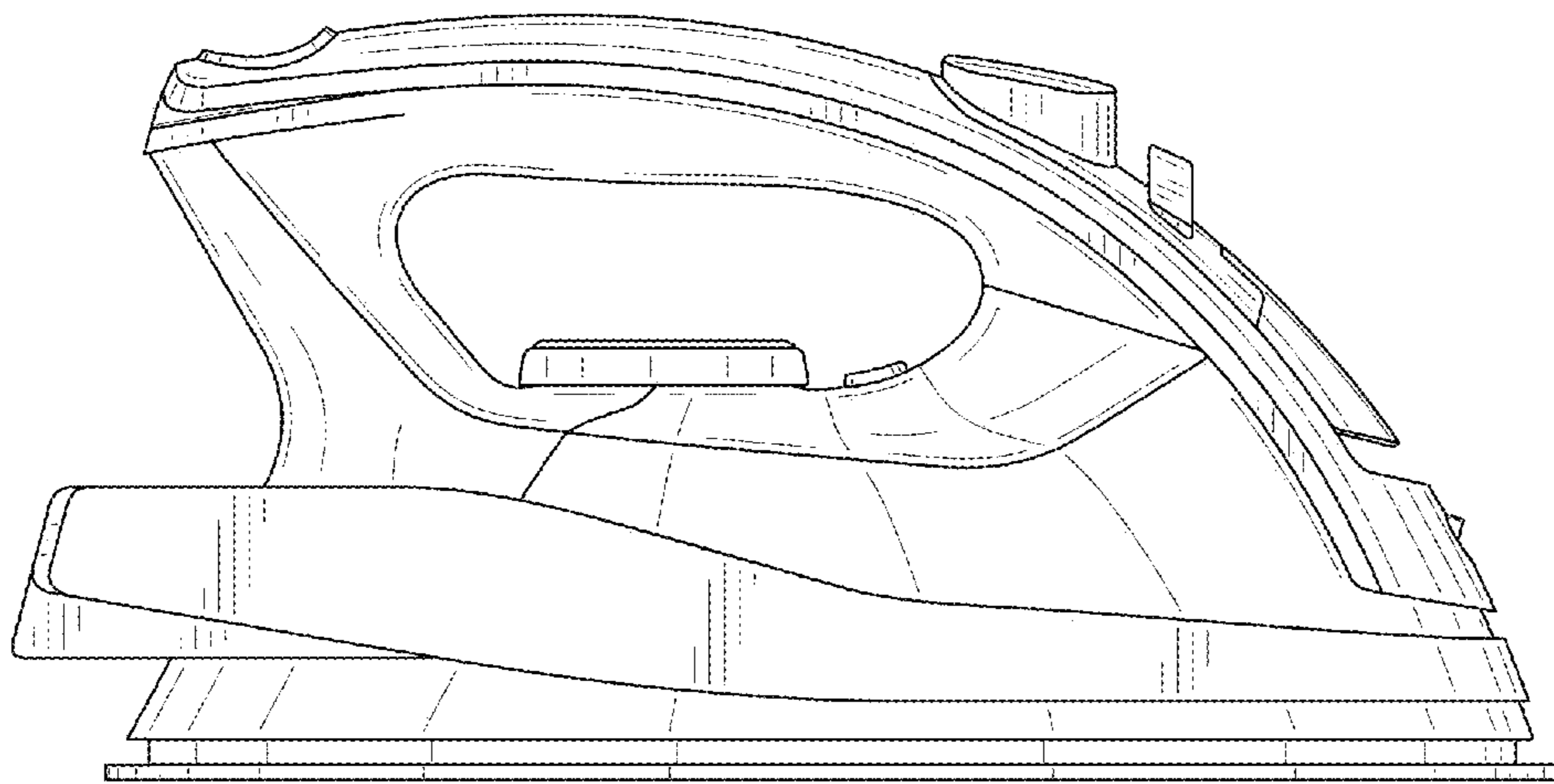

FIG.5

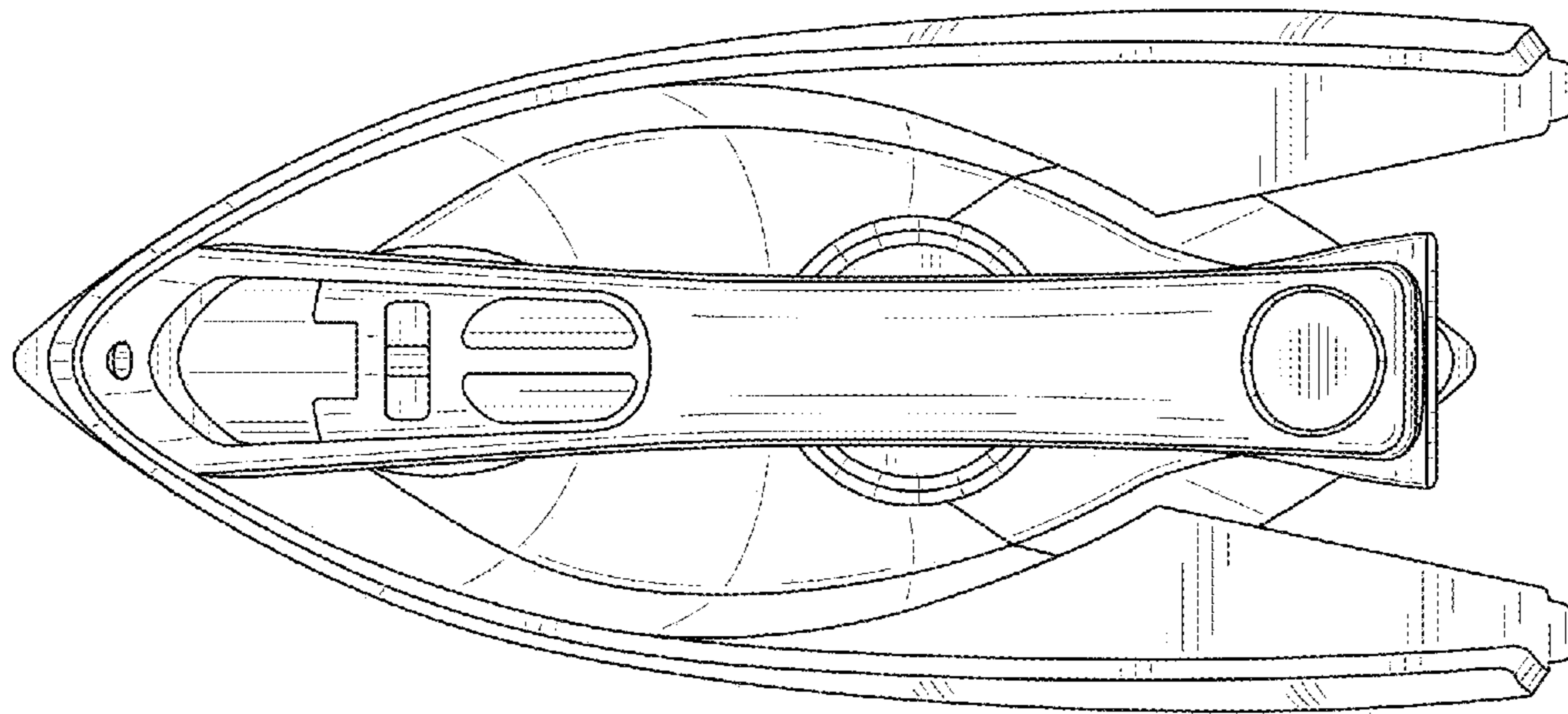

FIG.6

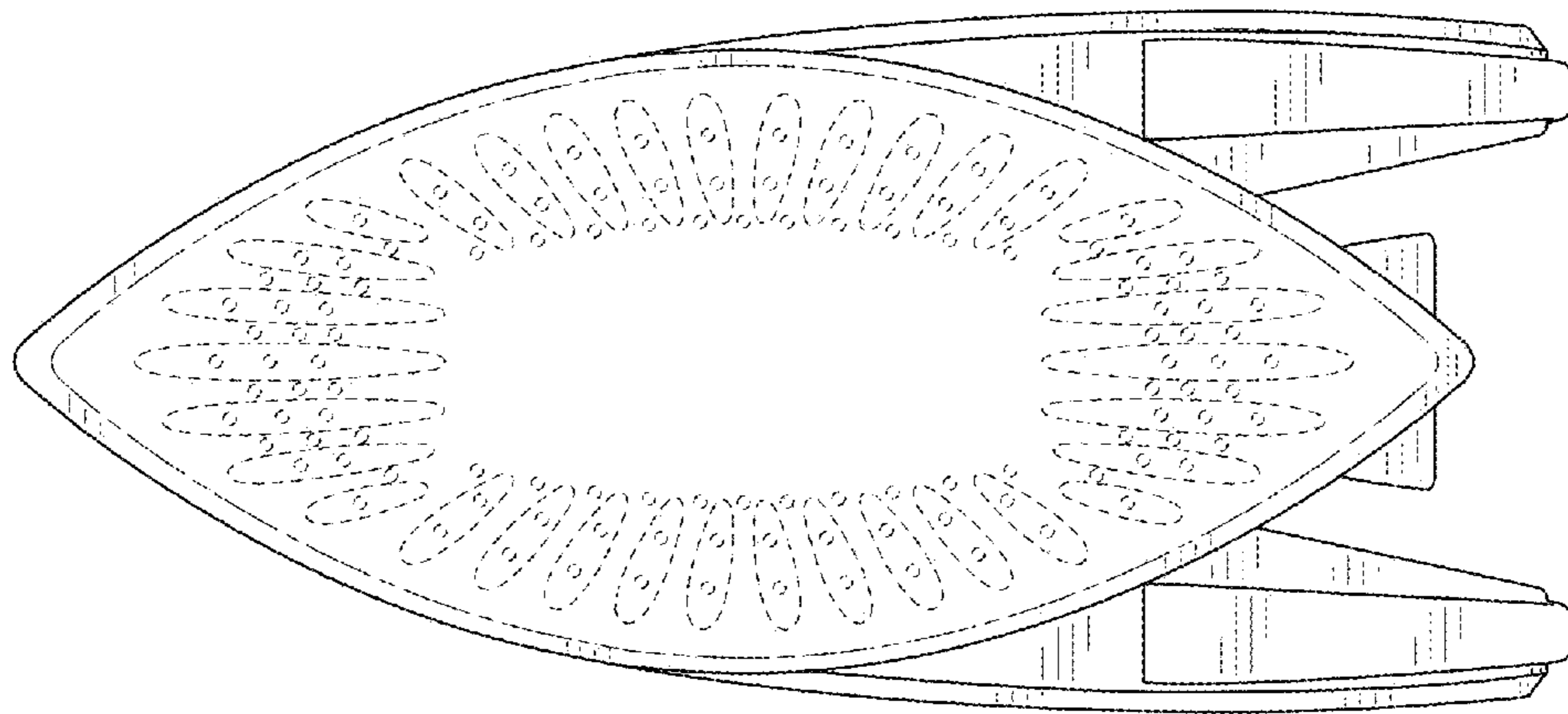

FIG.7

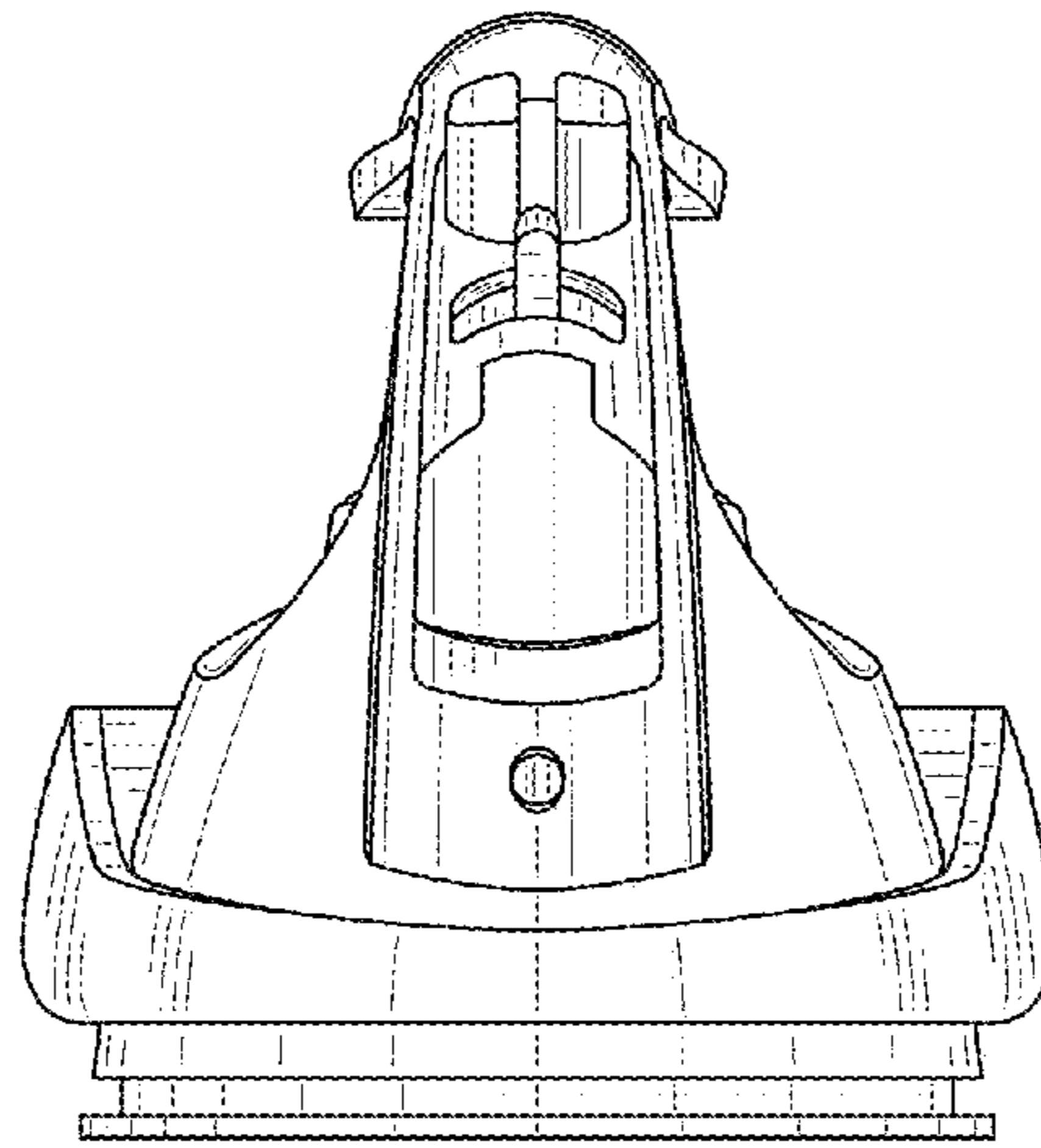

FIG.8

