



US00D671693S

(12) **United States Design Patent**  
**Ford**

(10) **Patent No.:** **US D671,693 S**  
(45) **Date of Patent:** **\*\* Nov. 27, 2012**

(54) **HORSE-BOOT UPPER**

(75) Inventor: **Garrett N. Ford**, Tucson, AZ (US)

(73) Assignee: **Easycare, Inc.**, Tucson, AZ (US)

(\*\*) Term: **14 Years**

(21) Appl. No.: **29/410,177**

(22) Filed: **Jan. 5, 2012**

*Primary Examiner* — Susan M Lee

*Assistant Examiner* — Linda G. Brooks

(74) *Attorney, Agent, or Firm* — Antonio R. Durando

(57) **CLAIM**

The ornamental design for a horse-boot upper, as shown and described.

**Related U.S. Application Data**

(63) Continuation-in-part of application No. 29/385,377, filed on Feb. 12, 2011, now Pat. No. Des. 652,178.

(51) **LOC (9) Cl.** ..... **30-01**

(52) **U.S. Cl.** ..... **D30/145**

(58) **Field of Classification Search** ..... D30/145–150;  
54/65, 82; 168/1–4, 14–18, 22; 36/110–115,  
36/117.1–117.5, 140; 602/6, 8, 23, 27–29,  
602/65, 66; 119/814, 850, 856

See application file for complete search history.

(56) **References Cited**

**U.S. PATENT DOCUMENTS**

3,800,504	A *	4/1974	Gregory	.....	54/82
5,224,549	A *	7/1993	Lightner	.....	168/18
5,715,661	A *	2/1998	Meyers	.....	54/82
D553,806	S *	10/2007	Giles et al.	.....	D30/146
7,434,378	B2 *	10/2008	Wilson	.....	54/82
D580,111	S *	11/2008	Lander	.....	D30/146
D629,977	S *	12/2010	Ford	.....	D30/146

\* cited by examiner

**DESCRIPTION**

FIG. 1 is a perspective view of a horse-boot upper showing my design with the retaining flap in closed position; FIG. 2 is a front elevational view thereof; FIG. 3 is a left-side elevational view thereof; FIG. 4 is a right-side elevational view thereof; FIG. 5 is a rear elevational view thereof; FIG. 6 is a top plan view thereof; and, FIG. 7 is another rear elevational view thereof showing the retaining flap in open position.

The blank portion contained within the dash-dot lines in the center area of FIGS. 1 and 6 forms no part of the claimed design. The dash-dot broken line showing the sole of the horse boot on the drawing disclosure is for illustrative purposes only and forms no part of the claimed design. The broken lines on the upper part of the horse boot represent stitches.

**1 Claim, 7 Drawing Sheets**

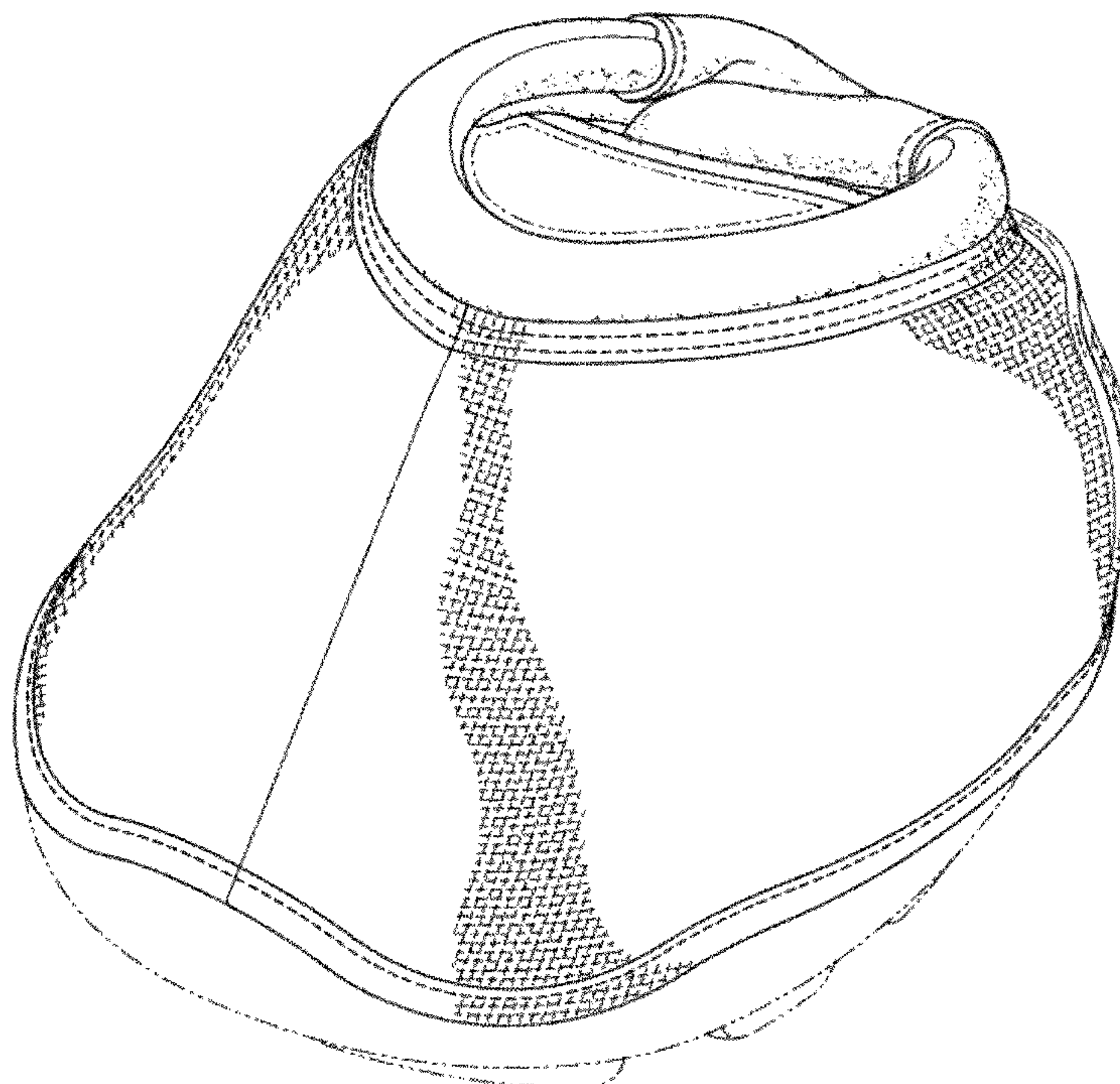

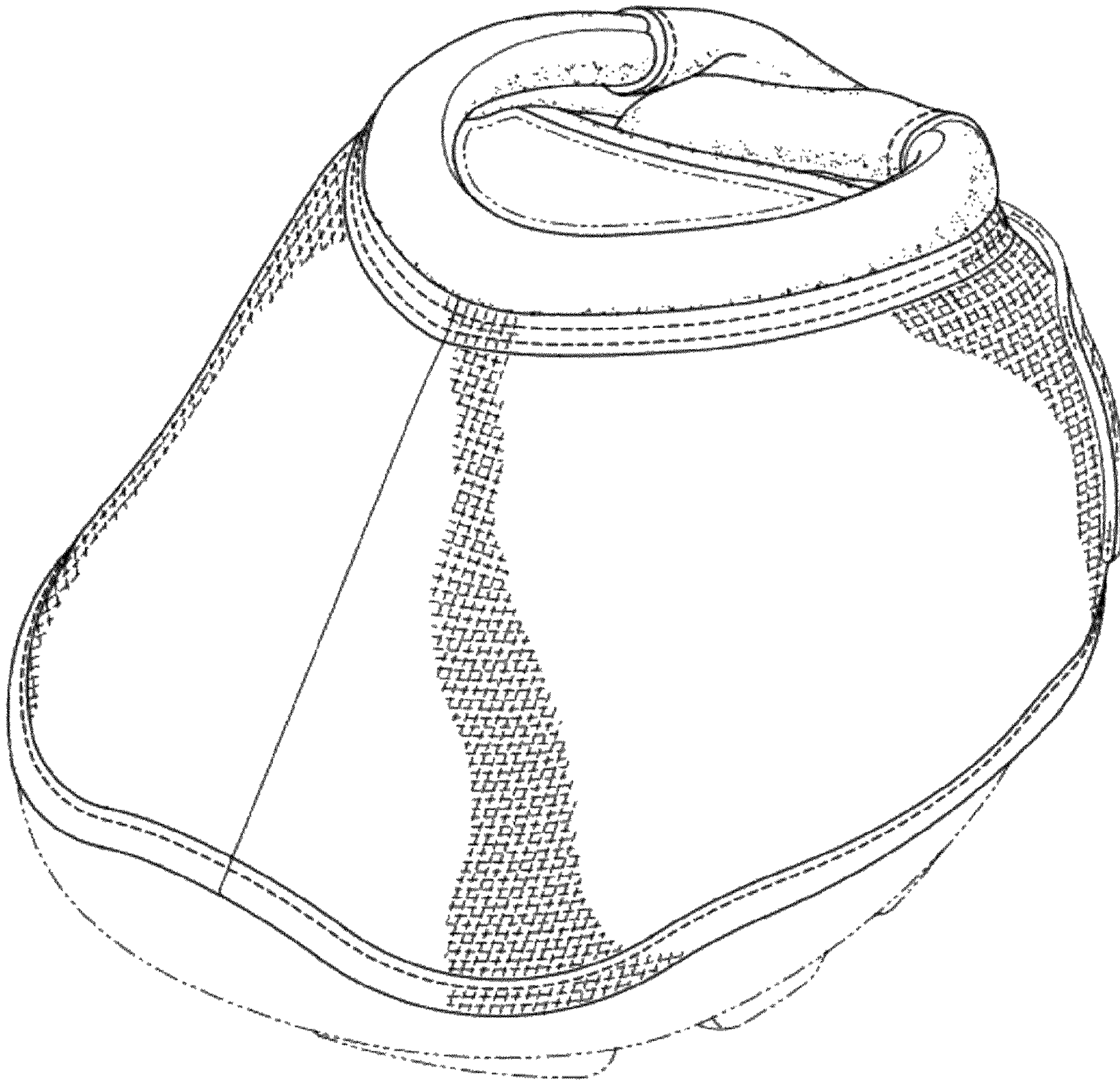

*FIG. 1*



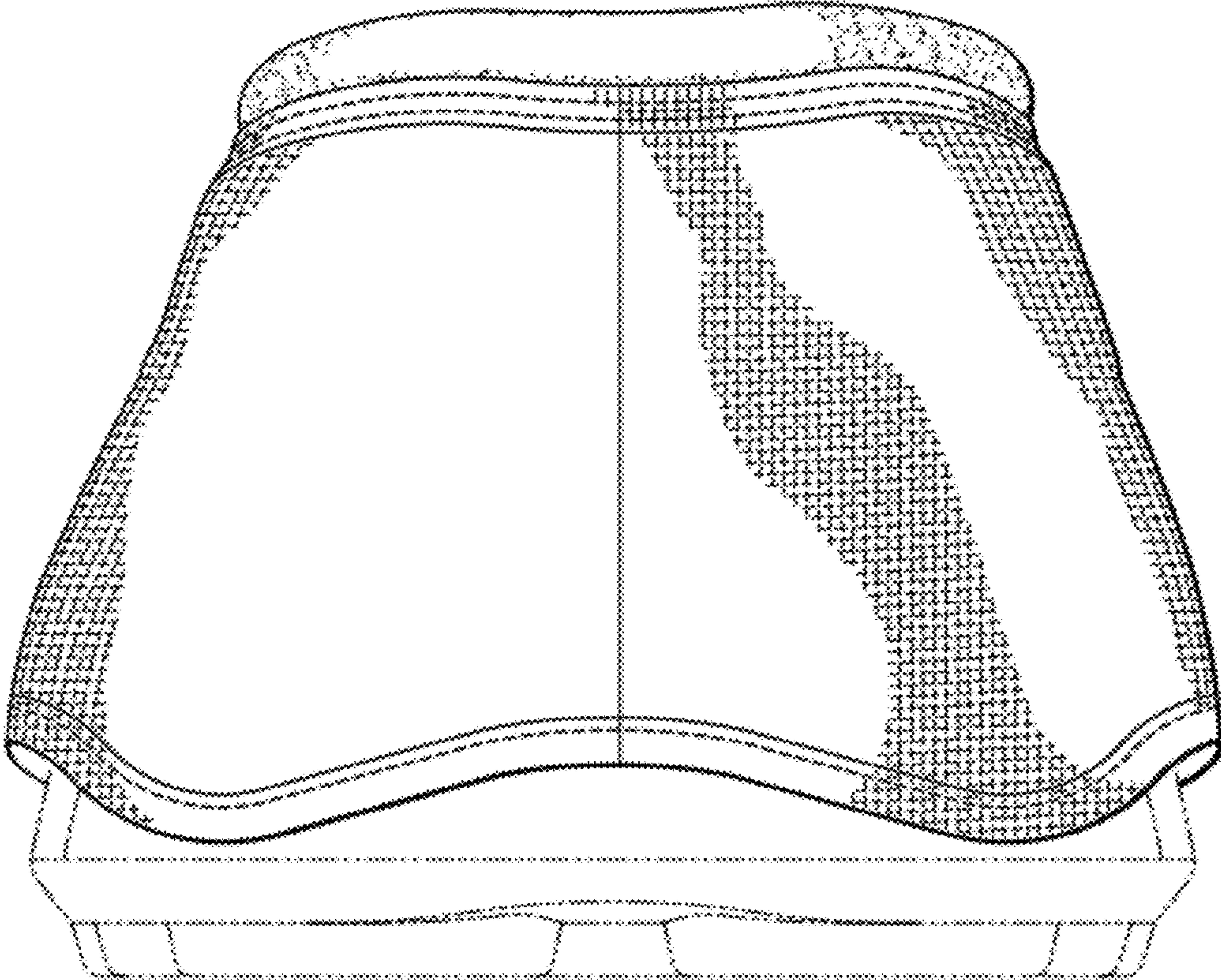

FIG. 2

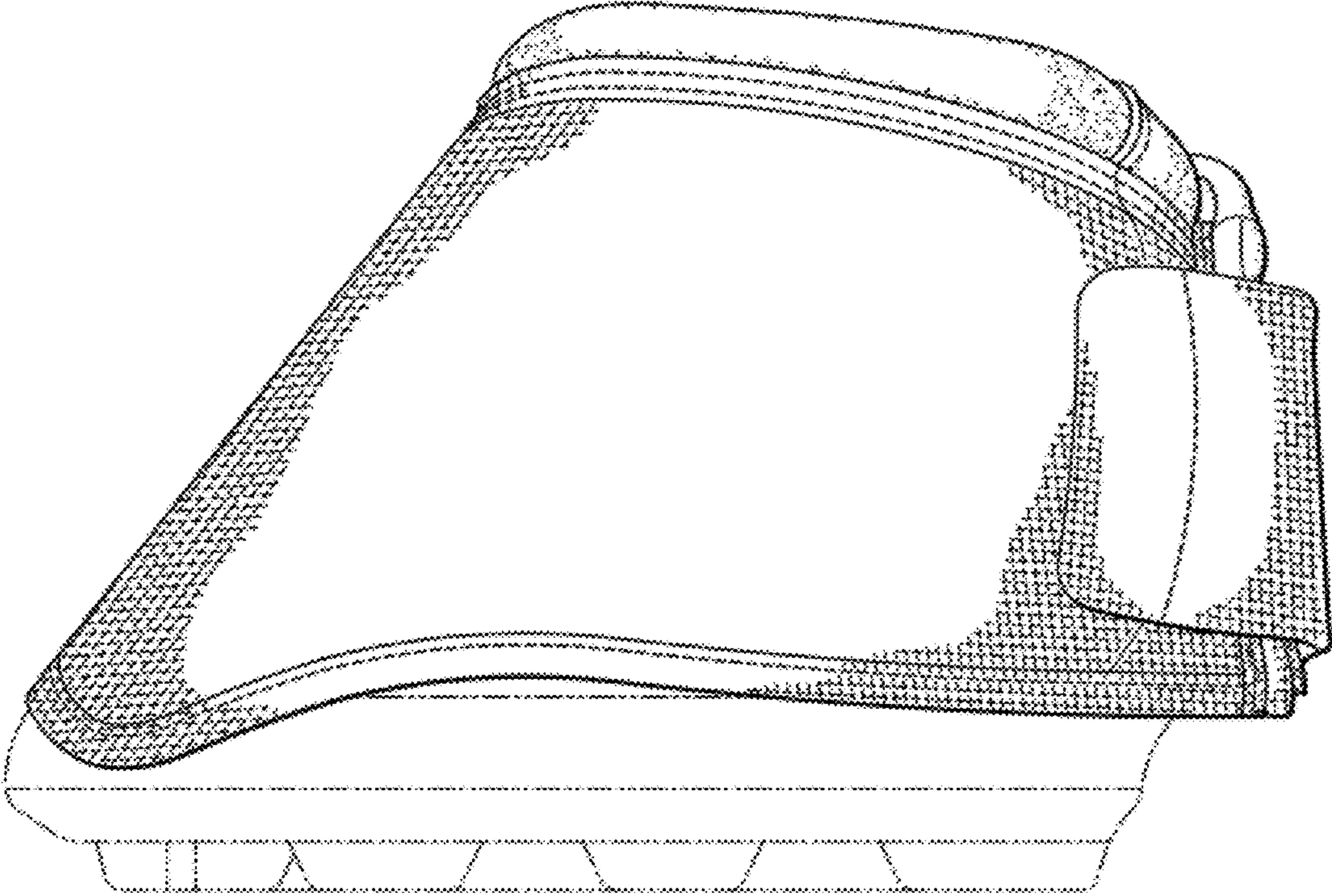

FIG. 3

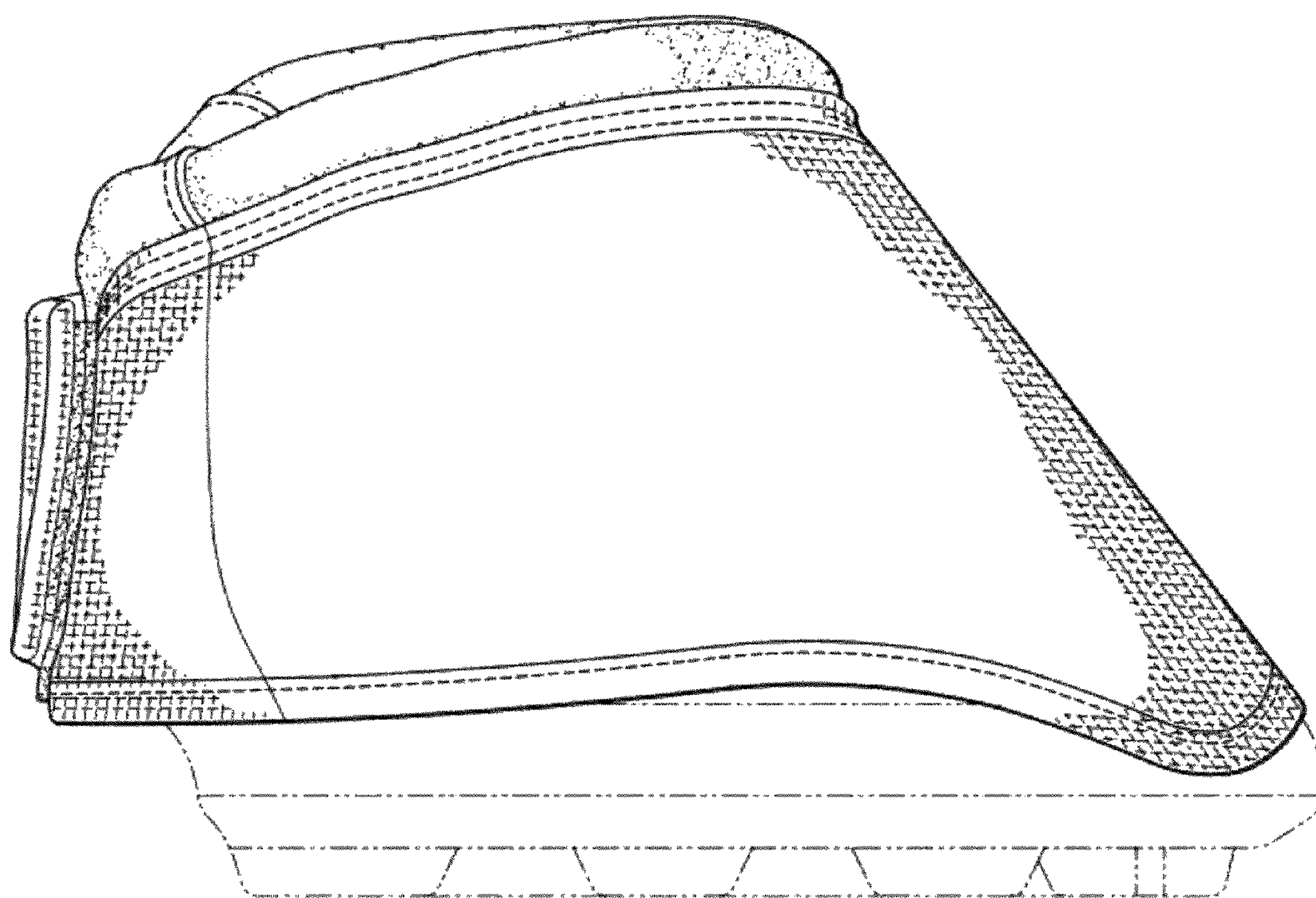
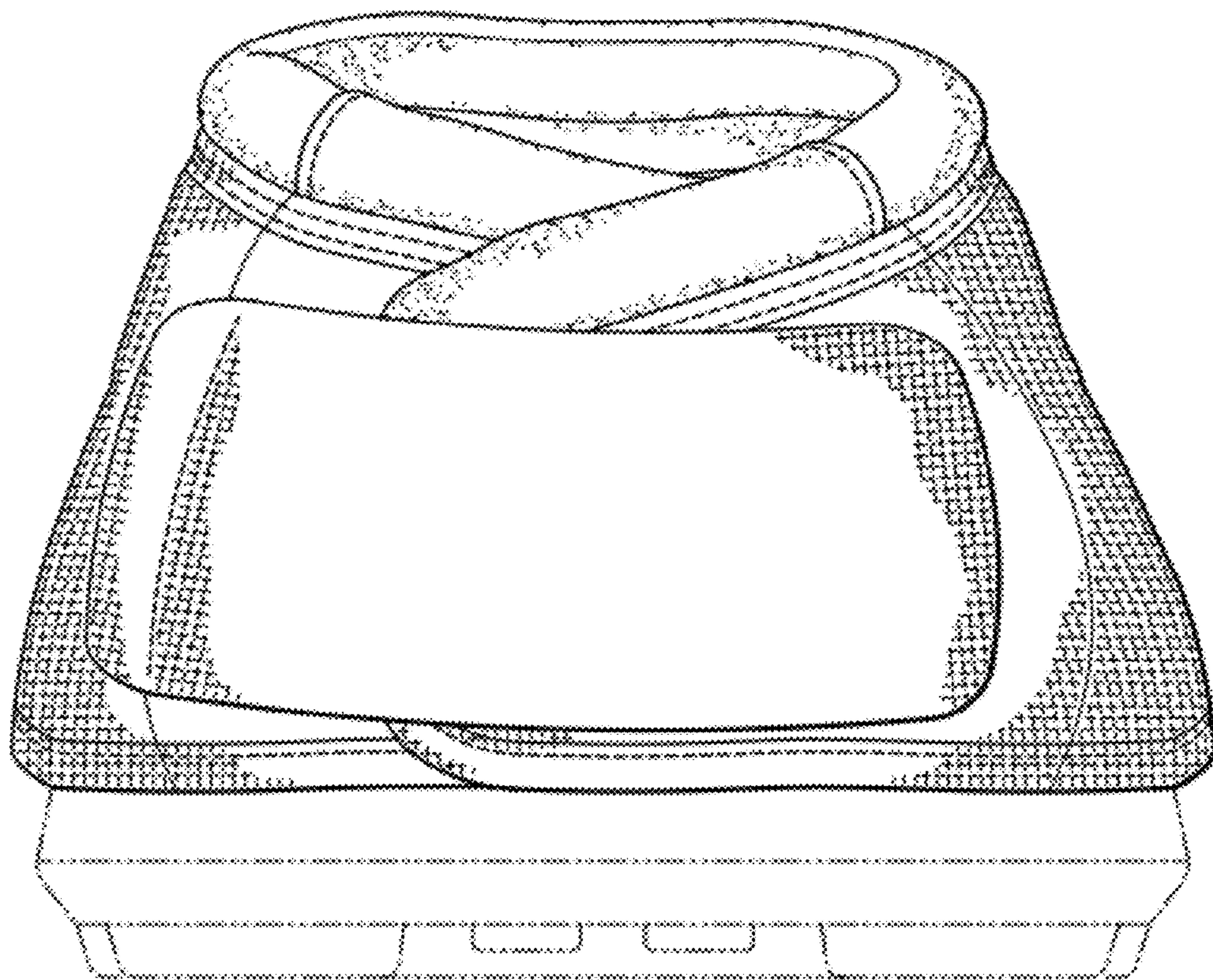

FIG. 4





*FIG. 5*

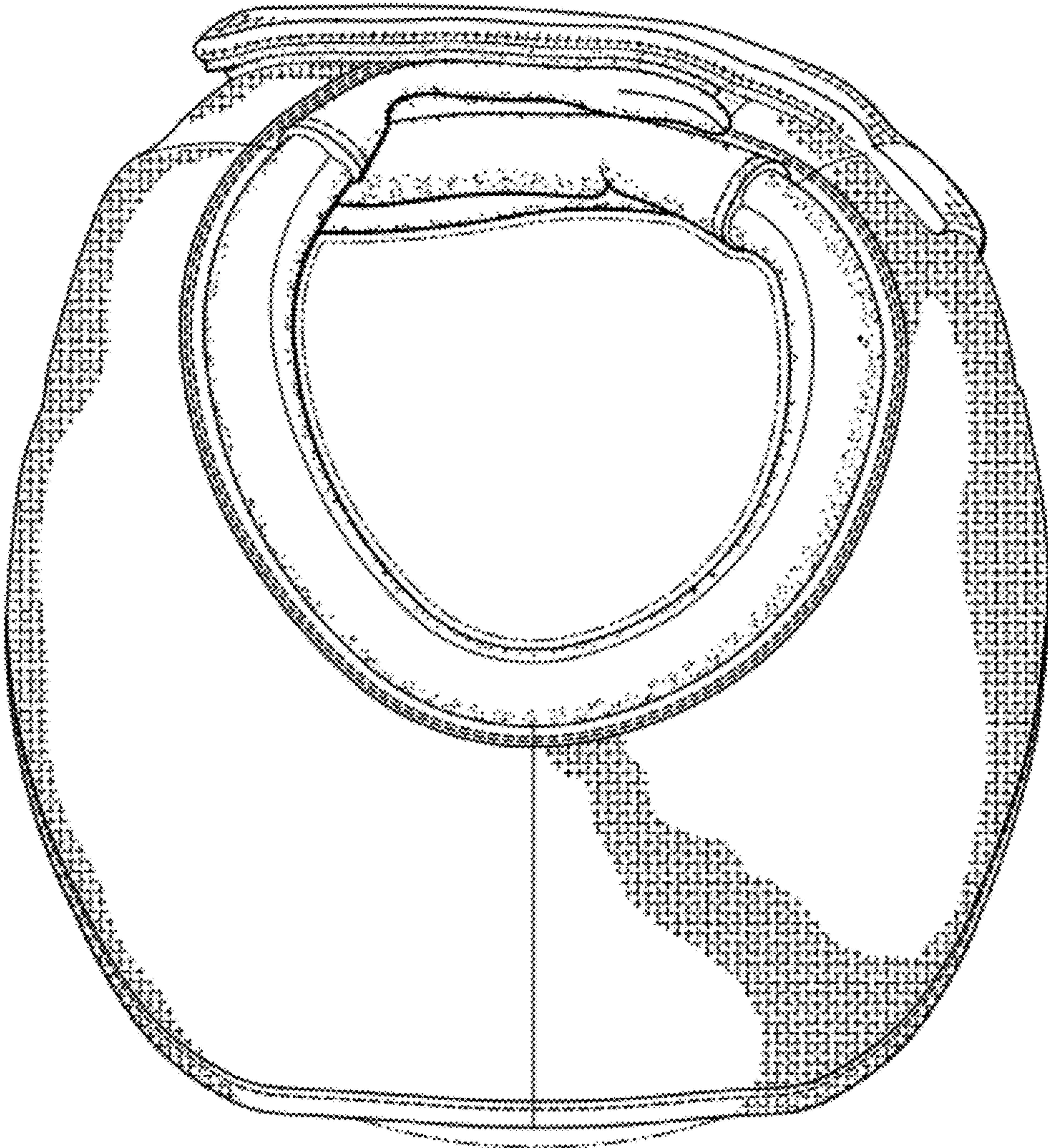

FIG. 6



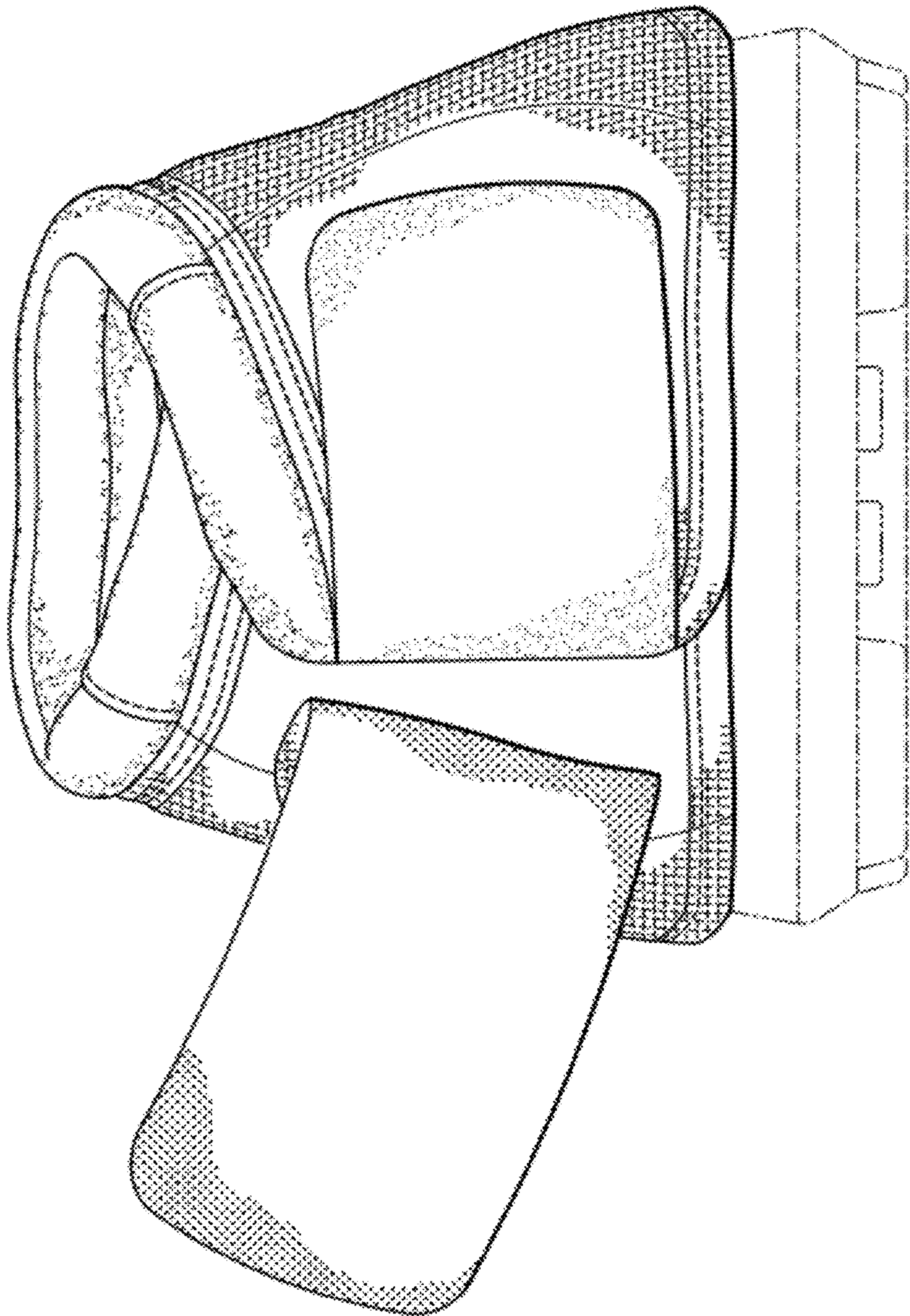

FIG. 7