



US00D671585S

(12) **United States Design Patent**  
**Mihara et al.**

(10) **Patent No.:** **US D671,585 S**

(45) **Date of Patent:** **\*\* Nov. 27, 2012**

(54) **VIDEO CAMERA WITH MEMORY CARD RECORDER**

(75) Inventors: **Masaya Mihara**, Yokohama (JP); **Shuji Tanifuji**, Yokohama (JP)

(73) Assignee: **Victor Company of Japan, Limited**, Kanagawa (JP)

(\*\*) Term: **14 Years**

(21) Appl. No.: **29/402,478**

(22) Filed: **Sep. 23, 2011**

(30) **Foreign Application Priority Data**

May 17, 2011 (JP) ..... 2011-010970

(51) **LOC (9) Cl.** ..... **16-01**

(52) **U.S. Cl.** ..... **D16/203**

(58) **Field of Classification Search** ..... D16/200–205,  
D16/208, 218; 348/373–376; 358/906; 396/427,  
396/535–541

See application file for complete search history.

(56) **References Cited**

**U.S. PATENT DOCUMENTS**

D307,915 S \* 5/1990 Kuester, III ..... D16/203  
D426,844 S \* 6/2000 Fujii ..... D16/203  
6,683,654 B1 \* 1/2004 Haijima ..... 348/374

D529,063 S \* 9/2006 Cheng ..... D16/203  
D531,200 S \* 10/2006 Taneno et al. .... D16/203  
D600,264 S \* 9/2009 Baumgartner ..... D16/203  
7,762,731 B2 \* 7/2010 Arbuckle et al. .... 396/427  
7,859,592 B2 \* 12/2010 Takahashi et al. .... 348/375

\* cited by examiner

*Primary Examiner* — Adir Aronovich

(74) *Attorney, Agent, or Firm* — Osha Liang LLP

(57) **CLAIM**

The ornamental design for video camera with memory card recorder, as shown and described.

**DESCRIPTION**

FIG. 1 is a perspective view of front, right and top of a video camera with memory card recorder showing our new design; FIG. 2 is a perspective view of rear, left and top thereof; FIG. 3 is a front elevational view thereof; FIG. 4 is a rear elevational view thereof; FIG. 5 is a left side elevational view thereof; FIG. 6 a right side elevational view thereof; FIG. 7 is a top plan view thereof; and, FIG. 8 is a bottom plan view thereof.

The broken lines showing of the video camera with memory card recorder is included for the purpose of illustrating portions of the video camera with memory card recorder and forms no part of the claimed design.

**1 Claim, 6 Drawing Sheets**

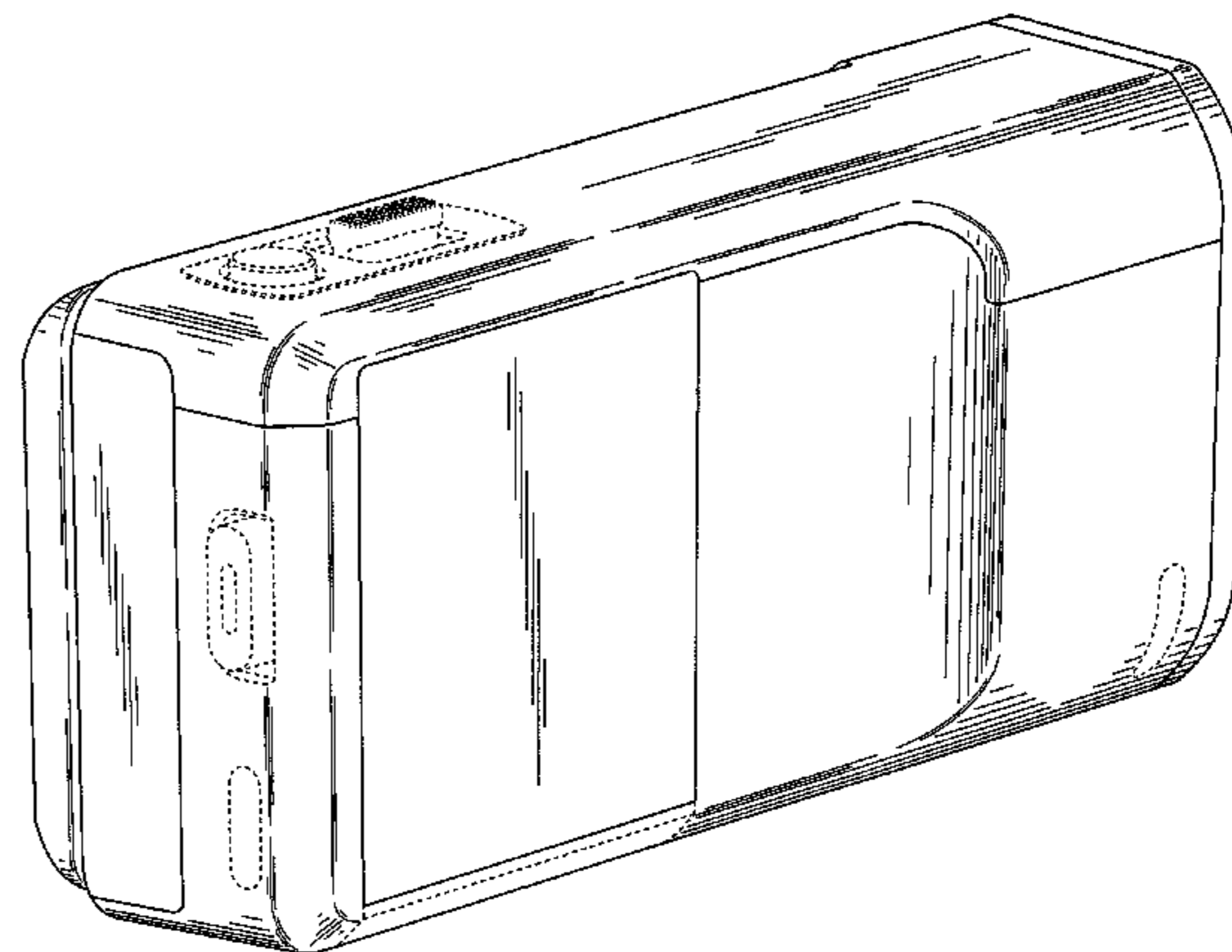
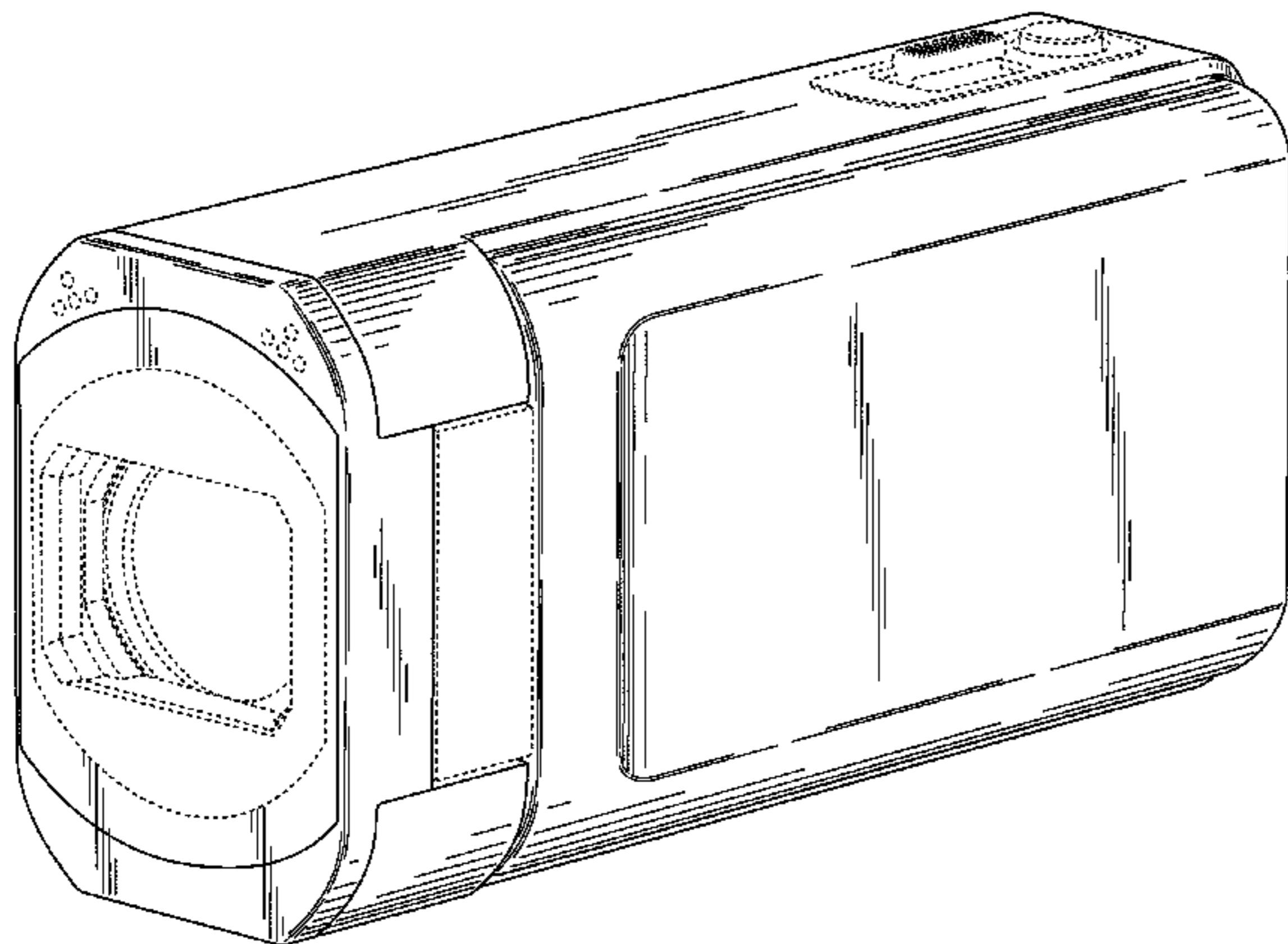

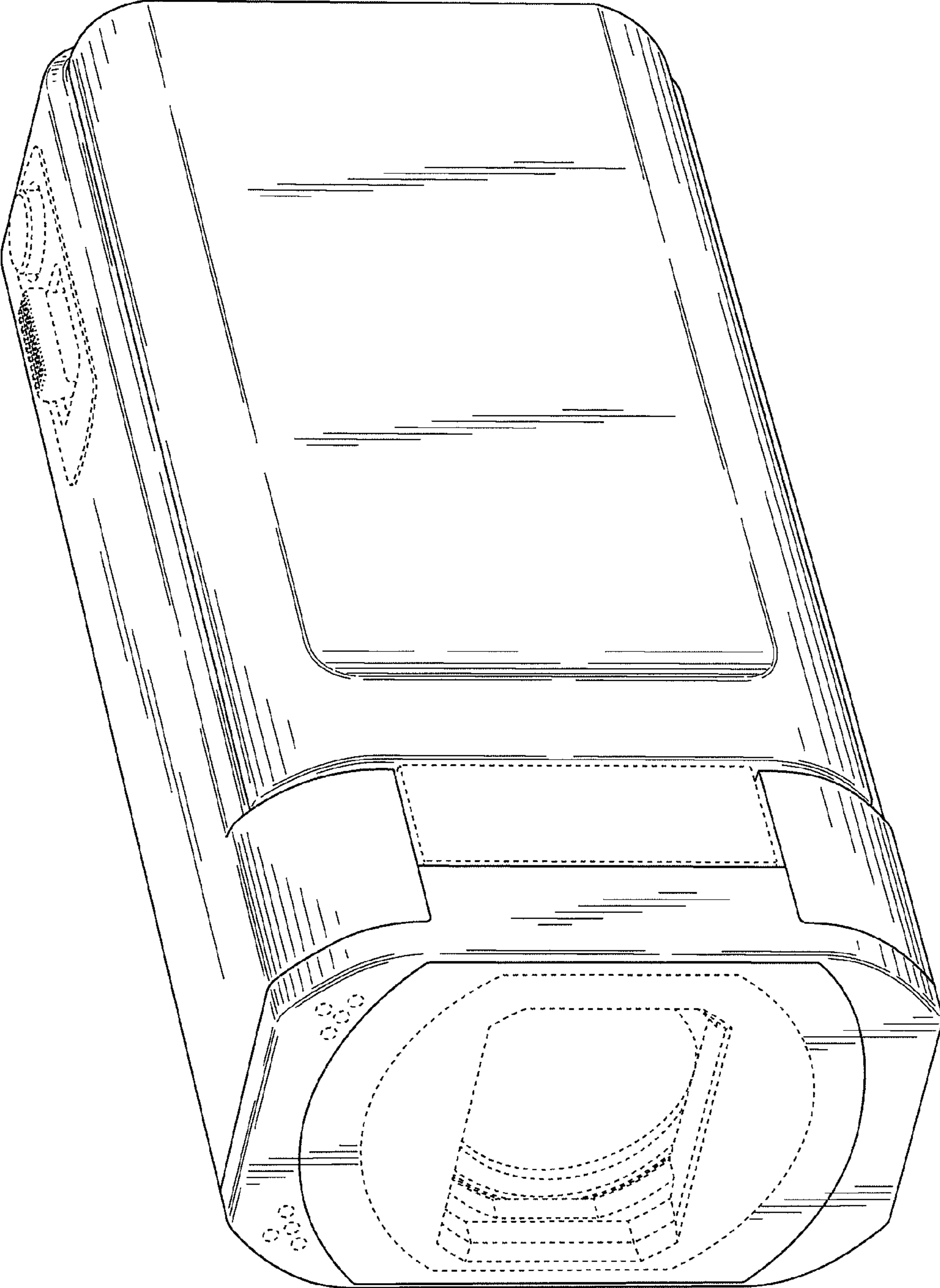

FIG. 1

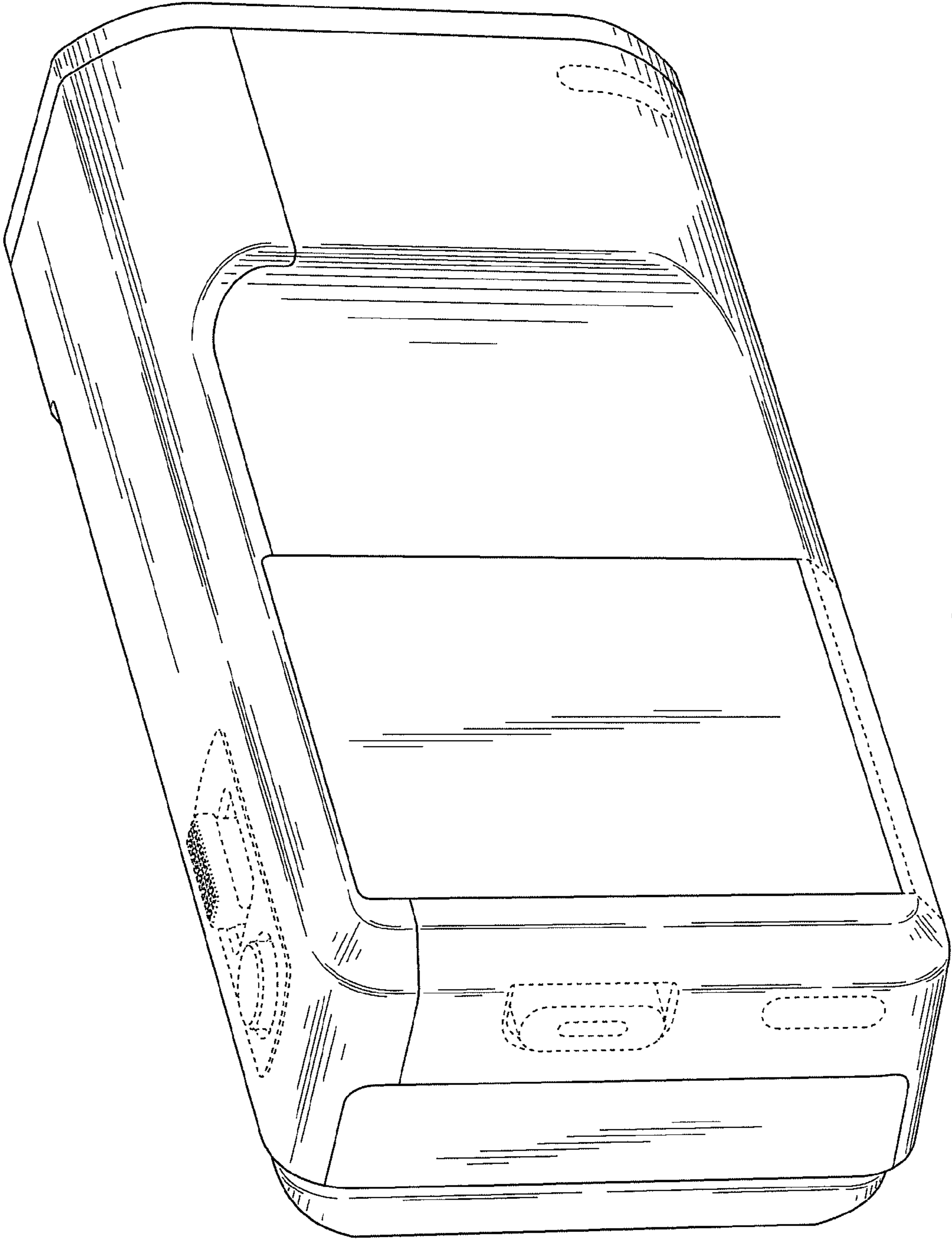

FIG. 2

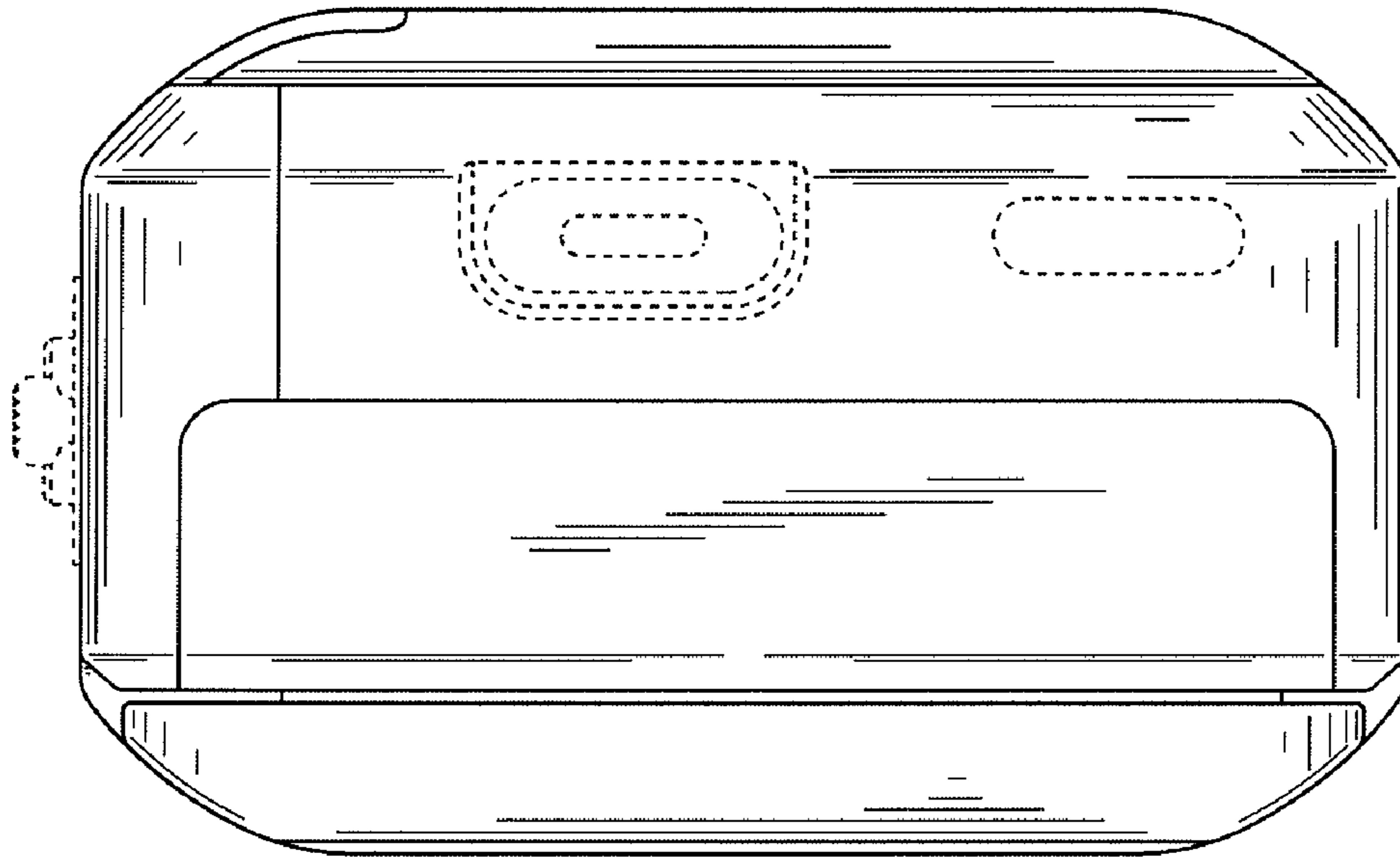

FIG. 4

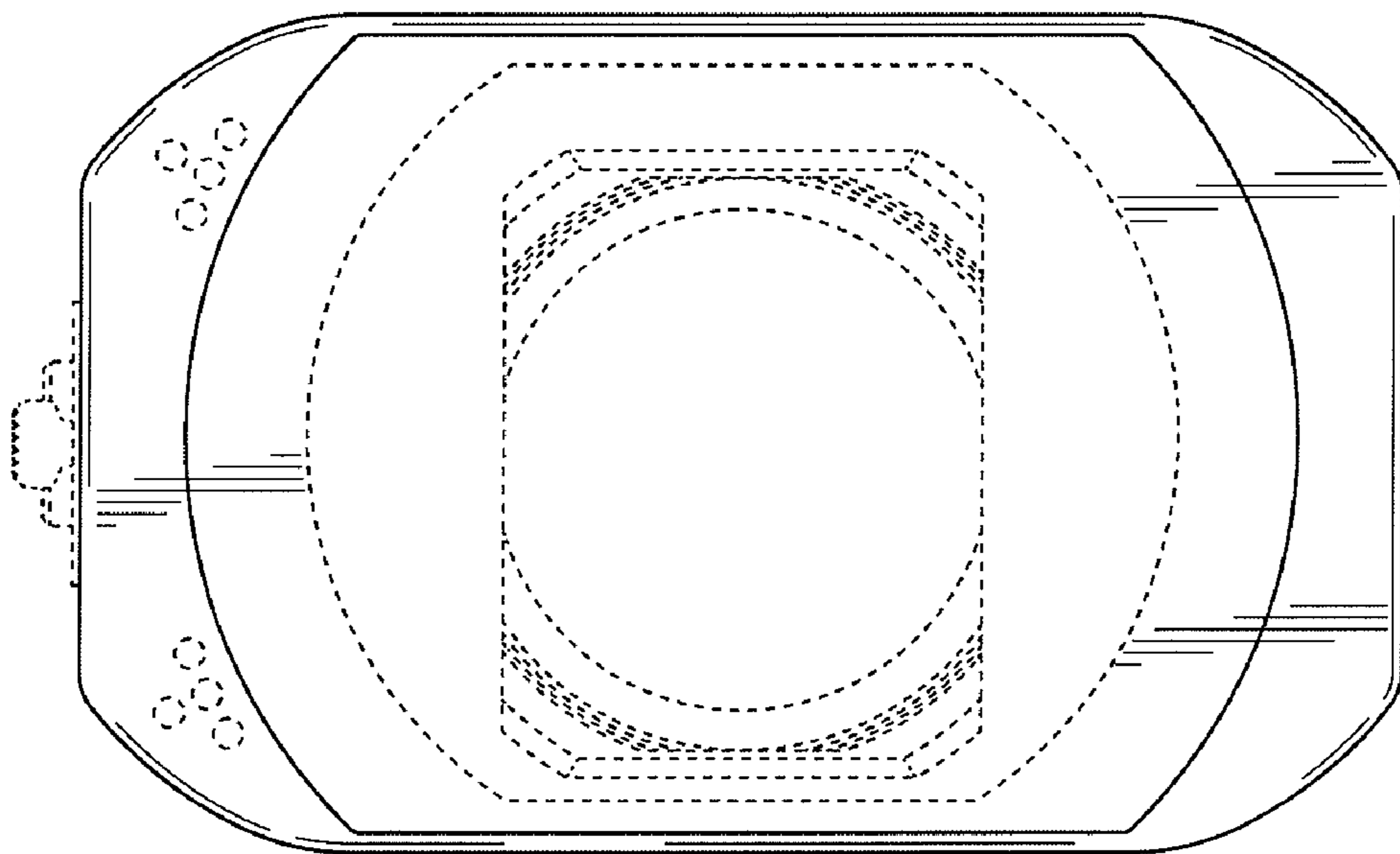

FIG. 3

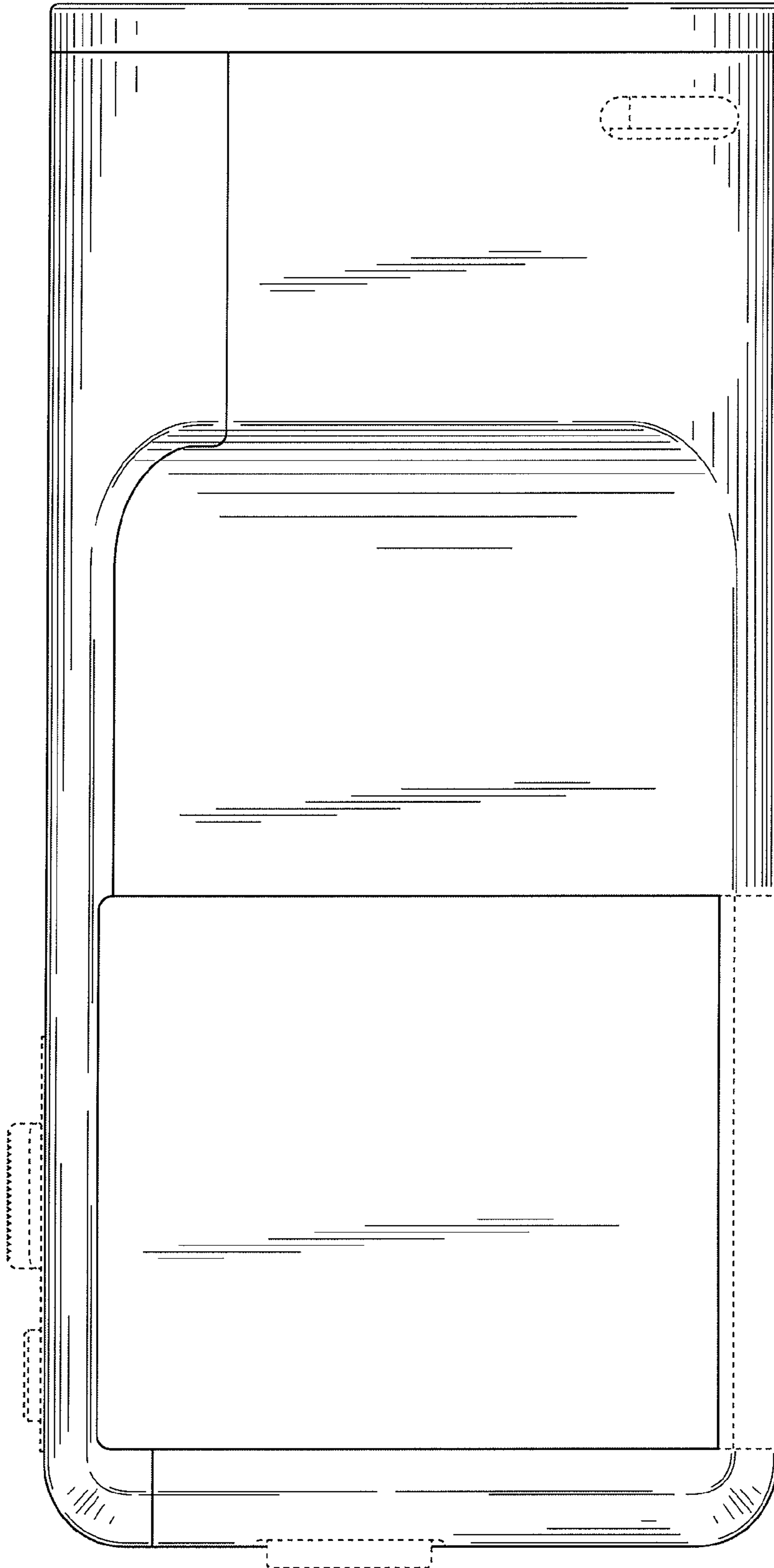

FIG. 5

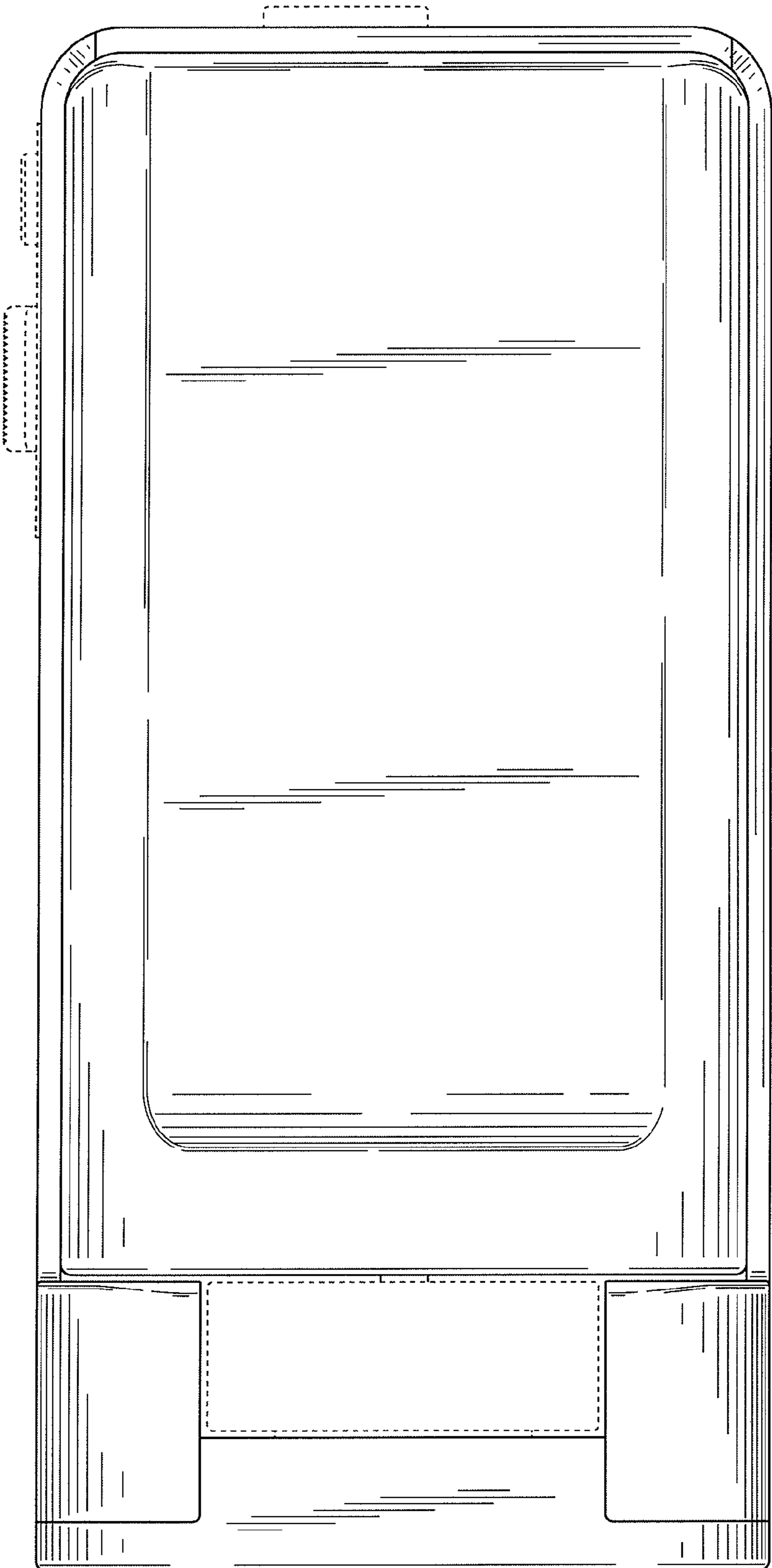

FIG. 6

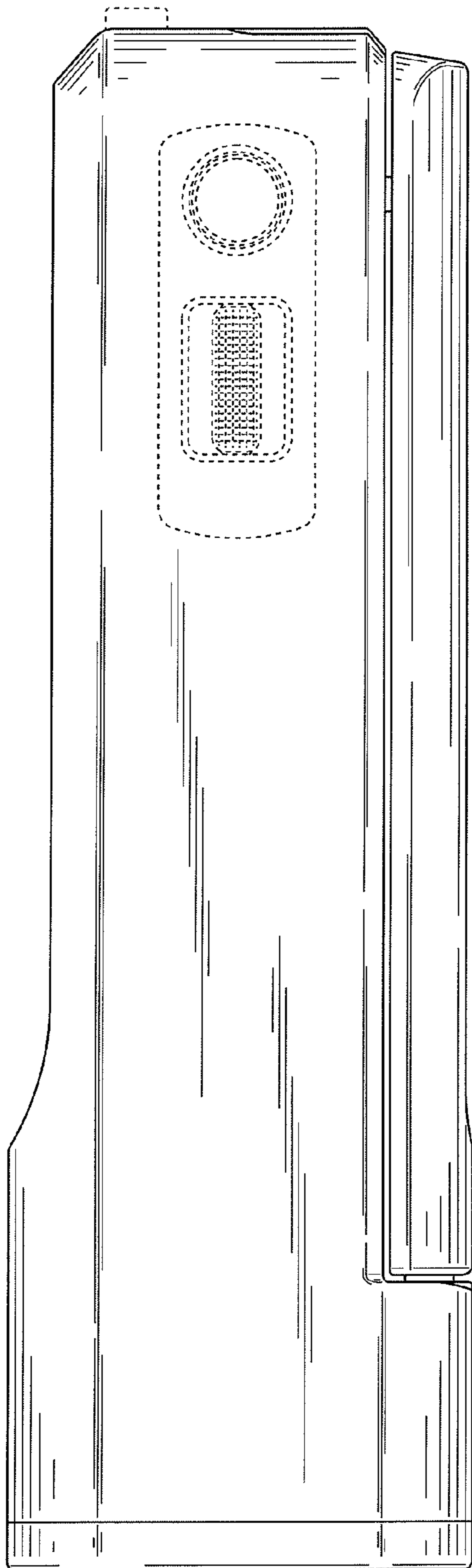

FIG. 7

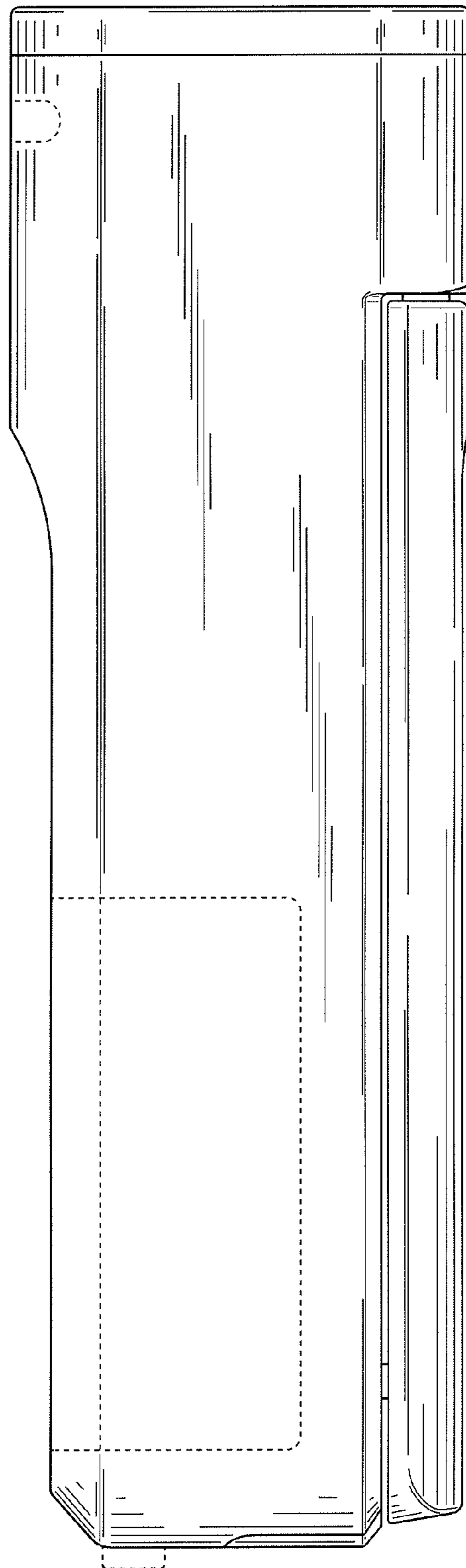

FIG. 8